

Synchronous Step-Up PFM DC/DC Converter

FEATURES

- **Operating Input Voltage Range:** 0.9 V ~ 5.5 V
- **Output Voltage Range:** 1.8 V~5.0 V with (0.1 V increments, accuracy $\pm 2.0\%$)
- **Built-in Switching NMOSFET** (0.6 Ω) and Synchronous Rectification PMOSFET (0.65 Ω)
- **Low Operating Supply Current:** 6.3 μA
- **High Speed Transient Response**
- **Load Disconnect Function** (IXD2140A)
- **Bypass Mode** (IXD2140C)
- **Small Package:** SOT-25 and USP-6EL
- **EU RoHS Compliant, Pb Free**

APPLICATION

- Mouse, Keyboards
- Cameras, VCRs
- Remote Control
- Game Consoles

TYPICAL APPLICATION CIRCUIT

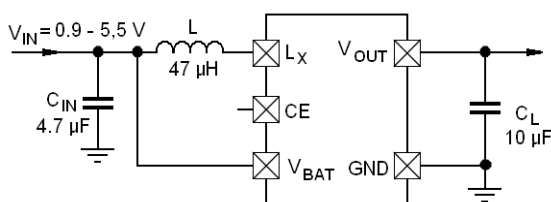

- Various portable equipment

DESCRIPTION

The IXD2140 IC is a step-up synchronous PFM DC/DC converter with internal 0.6 Ω N-channel switching and 0.65 Ω P-channel synchronous rectifier transistors.

PFM control enables a low quiescent current, making the IXD2140 ideal for portable devices that require high efficiency.

This IXD2140 converter maintains stable operation with low ESR ceramic capacitors at input and output.

The IXD2140 converter can start from 0.9 V input voltage if the output voltage is set to 3.3 V and load current is less than 1 mA, which allows use of the IXD2140 converter in applications powered from a single alkaline or nickel-metal hydride battery.

The output voltage is factory preset from 1.8 V to 5.0 V ($\pm 2.0\%$) in steps of 0.1 V.

The Load Disconnect Function to break continuity between the input and output at shutdown protects both battery and load from uncontrolled operation (IXD2140A).

A bypass mode function to maintain continuity between the input and output (IXD2140C) keeps battery connected to load, if it is important.

TYPICAL PERFORMANCE CHARACTERISTIC

Efficiency vs. Output Current
IXD2140A331MR-G, $V_{OUT} = 3.3\text{ V}$

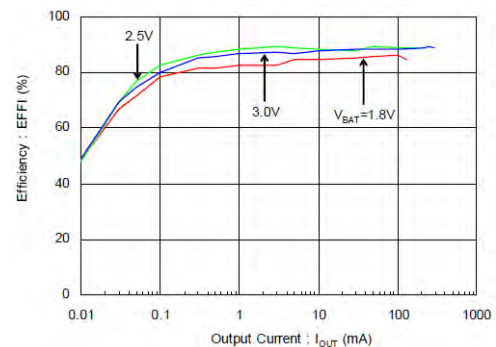

ABSOLUTE MAXIMUM RATINGS

PARAMETER		SYMBOL	RATINGS	UNITS
V _{OUT} Voltage		V _{OUT}	- 0.3 ~ 7.0	V
Lx Pin Voltage		V _{LX}	- 0.3 ~ V _{OUT} + 0.3 or 7.0 V ¹⁾	V
Lx Pin Current		I _{LX}	700	mA
BAT Pin Voltage		V _{BAT}	- 0.3 ~ 7.0	V
CE Pin Voltage		V _{CE}	- 0.3 ~ 7.0	V
Power Dissipation	SOT-25	P _D	250	mW
	USP-6EL		120	
Operating Temperature Range		T _{OPR}	- 40 ~ + 85	°C
Storage Temperature Range		T _{STG}	- 55 ~ +125	°C

Note:

* All voltages measured in respect to GND.

1) The maximum value should be either V_{OUT} + 0.3 V, or +7.0 V, which is the lowest.

ELECTRICAL OPERATING CHARACTERISTICS

IXD2140A/C

T_a = 25 °C

PARAMETER		SYMBOL	CONDITIONS	MIN.	TYP.	MAX.	UNIT	CIRCUIT
Input Voltage		V _{BAT}				5.5	V	
Output Voltage		V _{OUT(E)} ²⁾	V _{PULL} = 1.5 V, Voltage to start oscillations, while V _{OUT} is decreasing		E1		V	①
Operating Start Voltage ⁶⁾		V _{ST}	I _{OUT} = 1 mA,	-		0.9	V	②
Operating Stop Voltage ⁷⁾		V _{HLD}	R _L = 1 kΩ	-	0.7		V	②
Supply Current		I _Q	Oscillations stop, V _{OUT} = V _{OUT(T)} + 0.5 V ¹⁾		E2		μA	⑤
Input Pin Current		I _{BAT}	V _{OUT} = V _{OUT(T)} + 0.5 V ¹⁾	-	0.25	1.0	μA	⑤
Standby Current	IXD2140A	I _{STBA}	V _{BAT} = V _{LX} = V _{OUT(T)} ¹⁾ , V _{OUT} = V _{CE} = 0	-	0.1	1.0	μA	④
	IXD2140C	I _{STBC}	V _{BAT} = V _{LX} = 5.5 V, V _{CE} = 0		3.5	6.1	μA	⑥
Lx Leakage Current		I _{LXL}	V _{BAT} = V _{LX} = V _{OUT(T)} ¹⁾ , V _{OUT} = V _{CE} = 0	-	0.1	1.0	μA	⑤
Switching Current Limit		I _{PFM}	I _{OUT} = 3 mA	295	350	405	mA	②
Maximum ON Time		t _{ON_MAX}	V _{PULL} = 1.5 V, V _{OUT} = V _{OUT(T)} × 0.98 ¹⁾	3.1	4.6	6.0	μs	①
Lx P-Channel Switch ON Resistance ³⁾		R _{LXP}	V _{BAT} = V _{LX} = V _{CE} = V _{OUT(T)} + 0.5 V ¹⁾ I _{OUT} = 200 mA		E3		Ω	⑦
Lx N-Channel Switch ON Resistance		R _{LXN}	V _{BAT} = V _{CE} = 3.3 V, V _{OUT} = 1.7 V		0.6		Ω	⑧
CE "High" Voltage		V _{CEH}	V _{BAT} = V _{PUL} = 1.5 V, V _{OUT} = V _{OUT(T)} × 0.98 ¹⁾	0.75 ⁶⁾		5.5	V	①
CE "Low" Voltage		V _{CEL}	V _{BAT} = V _{PUL} = 1.5 V, V _{OUT} = V _{OUT(T)} × 0.98 ¹⁾	0		0.3 ⁷⁾	V	①
CE "High" Current		I _{CEH}	V _{BAT} = V _{CE} = V _{LX} = V _{OUT} = 5.5 V	-0.1		0.1	μA	①
CE "Low" Current		I _{CEL}	V _{BAT} = V _{LX} = V _{OUT} = 5.5 V, V _{CE} = 0 V	-0.1		0.1	μA	①
Efficiency ⁴⁾		EFFI	V _{BAT} = V _{CE} = 1.8 V, V _{OUT(T)} = 2.5 V ¹⁾ , I _{OUT} = 30 mA		81		%	②
Efficiency ⁴⁾		EFFI	V _{BAT} = V _{CE} = 1.8 V, V _{OUT(T)} = 3.3 V ¹⁾ , I _{OUT} = 30 mA		85		%	②
Efficiency ⁴⁾		EFFI	V _{BAT} = V _{CE} = 1.8 V, V _{OUT(T)} = 5.0 V, I _{OUT} = 30 mA		86		%	②

NOTE:

Unless otherwise stated, V_{BAT} = V_{CE} = 1.5 V

1) V_{OUT(T)} - Nominal Output Voltage

2) V_{OUT(E)} - Effective Output Voltage, ripple component including.

3) R_{LXP} = (V_{LX} - V_{OUT}) / 200 mA

4) EFFI = [((Output Voltage) × (Output Current)) / ((Input Voltage) × (Input Current))] × 100%

5) R_{LXN} measurement method is shown in the circuit diagram.

6) Minimum Input voltage, at which output voltage reach programmed value

7) Maximum Input voltage, at which output voltage falls below programmed value

ELECTRICAL OPERATING CHARACTERISTICS (Continued)

SYMBOL PARAMETER	E1		E2		E3	
	OUTPUT VOLTAGE		SUPPLY CURRENT		LX SWITCH P-CHANNEL ON RESISTANCE	
UNITS, V	UNITS, V		UNITS, μ A		UNITS, Ω	
1.8	1.764	1.836	6.1	9.4	0.84	1.08
1.9	1.862	1.938				
2.0	1.960	2.040				
2.1	2.058	2.142				
2.2	2.156	2.244				
2.3	2.254	2.346	6.2	9.7	0.75	0.97
2.4	2.352	2.448				
2.5	2.450	2.550				
2.6	2.548	2.652				
2.7	2.646	2.754				
2.8	2.744	2.856	6.3	10.0	0.65	0.85
2.9	2.842	2.958				
3.0	2.940	3.060				
3.1	3.038	3.162				
3.2	3.136	3.264				
3.3	3.234	3.366	6.4	10.2	0.61	0.78
3.4	3.332	3.468				
3.5	3.430	3.570				
3.6	3.528	3.672				
3.7	3.626	3.774				
3.8	3.724	3.876	6.5	10.4	0.57	0.74
3.9	3.822	3.978				
4.0	3.920	4.080				
4.1	4.018	4.182				
4.2	4.116	4.284				
4.3	4.214	4.386	6.7	10.7	0.53	0.72
4.4	4.312	4.488				
4.5	4.410	4.590				
4.6	4.508	4.692				
4.7	4.606	4.794				
4.8	4.704	4.896				
4.9	4.802	4.998				
5.0	4.900	5.100				

PIN CONFIGURATION

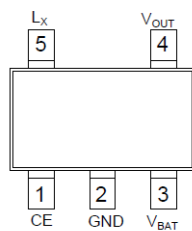

SOT-25
(TOP VIEW)

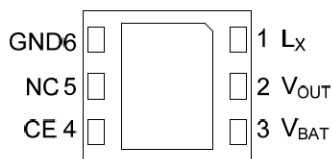

USP-6EL
(BOTTOM VIEW)

The dissipation pad for the USP-6EL package should be solder-plated in recommended mount pattern and metal masking to enhance mounting strength and heat release. If the pad needs to be connected to other pins, it should be connected to the pin No.6 (GND).

PIN ASSIGNMENT

PIN NUMBER		PIN NAME	FUNCTIONS
USP-6EL	SOT-25		
1	5	L _X	Switching Node
2	4	V _{OUT}	Output Voltage
3	3	V _{BAT}	Power Input
4	1	CE	Chip Enable; CE = LOW – standby mode, CE = High –Active mode
5	-	NC	No Connection
6	2	GND	Ground

BLOCK DIAGRAM

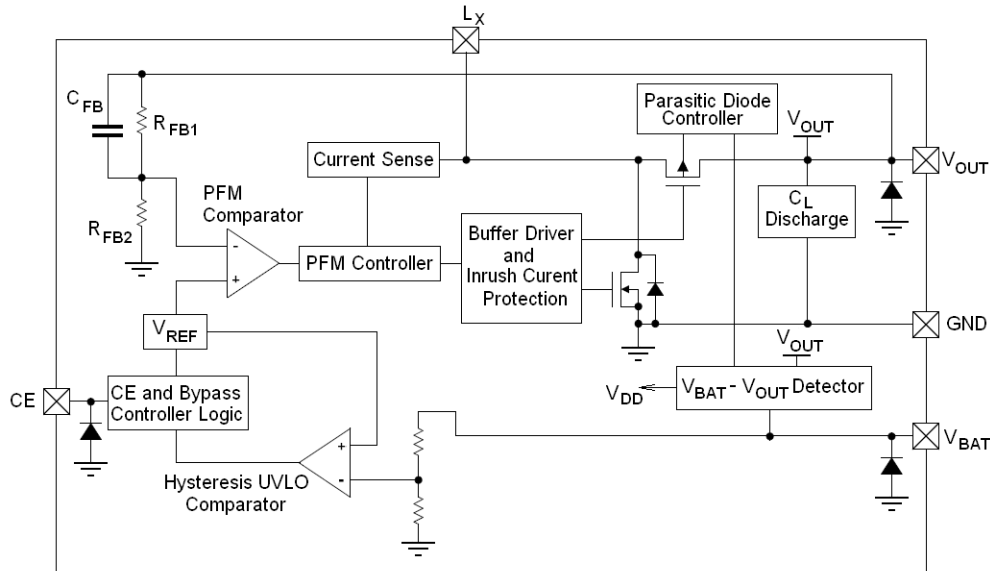

Diodes inside the circuits are ESD protection diodes and parasitic diodes.
The IXD2140A and IXD2140C do not have the C_L discharge function.
The IXD2140Axx1 and IXD2140Cxx1 do not have the UVLO function.

BASIC OPERATION

The IXD2140 IC consists of a Reference Voltage source, a PFM comparator; an N-channel switching transistor, a P-channel synchronous rectifier transistor, a current sense circuit, a PFM control circuit, a CE control circuit, and other blocks (refer to the block diagram).

The IXD2140 operates in a burst mode to maximize efficiency at wide range of the input voltages and output currents. In addition, this mode guarantees excellent transient response, which allows use of small ceramic capacitors to create a compact, high-performance boost DC/DC converter.

The synchronous rectification allows utilize maximum energy stored in inductor to achieve high efficiency at low and high load.

However, burst mode is associated with ripple noise at the output voltage required to trip PFM comparator. Therefore, effective output voltage V_{OUT(E)} includes ripple component that should be taken in to consideration by designers and carefully evaluated before using in the actual product. Typical curves for L_X and V_{OUT} pins shown below.

V_{BAT} = V_{CE} = 2.0 V, V_{OUT} = 3.3 V, I_{OUT} = 20 mA, L = 4.7 μH, C_L = 10 μF, T_a = 25 °C

V_{BAT} = V_{CE} = 2.0 V, V_{OUT} = 3.3 V, I_{OUT} = 70 mA, L = 4.7 μH, C_L = 10 μF, T_a = 25 °C

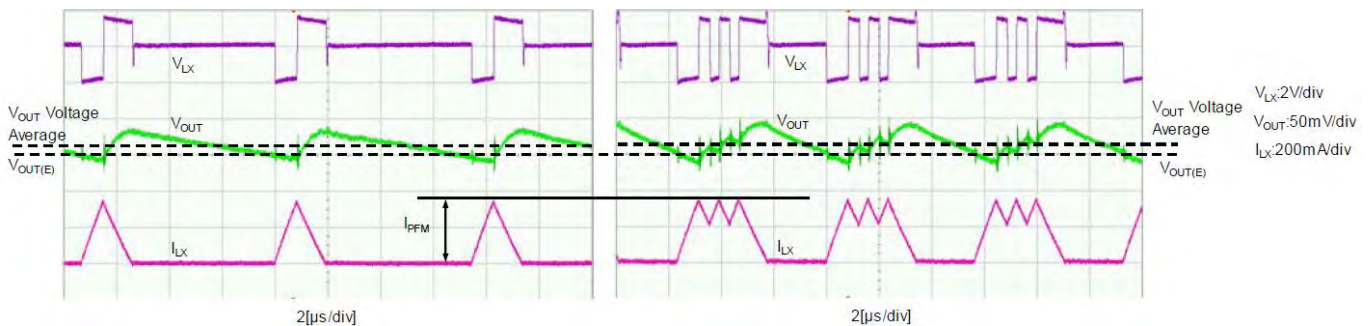

Reference Voltage Source (V_{REF})

The Reference Voltage source provides the internal reference to ensure stable output voltage of the DC/DC converter.

PFM Comparator

The PFM Comparator compares reference voltage with feedback signal, which is an output voltage divided by internal resistive divider. If value of the feedback signal falls below V_{REF} , PFM Comparator turns on PFM Controller to start pulse sequence and charge output capacitor C_L . When value of the feedback signal becomes higher than V_{REF} , PFM Comparator turns off PFM Controller, which stops pulse sequence.

Current Sense circuit

The current sense circuit monitors the inductor current flowing through the N-channel transistor connected to the L_X pin, when this transistor is ON.

When inductor current becomes equal I_{PFM} value, Current Sense circuit sends signal to the PFM Controller, which turns OFF the N-channel transistor and turns ON the P-channel synchronous rectifier transistor. However, if the load becomes much larger than the energy provided by converter, the V_{OUT} voltage falls below V_{BAT} voltage. At this condition, controller cannot regulate inductor current, which may exceed I_{PFM} value and destroy P-channel transistor.

PFM Controller

The PFM Controller operates N-channel and P-channel transistors through Buffer Driver to keep output voltage stable, adjusting on/off time dynamically in respect to load. If energy provided to the load in a single pulse is enough to trigger PFM comparator, PFM controller stops generating pulses until output voltage falls below PFM Comparator's threshold. After that, PFM controller generates next pulse. Pulse frequency depends on load, increasing with the load current. However, at high load, energy provided to the load in a single pulse may be not enough to trigger PFM comparator, and next pulse will be generated immediately after V_{LX} pin voltage falls below V_{OUT} . At this condition, IXD2140 operates in continuous conduction mode generating sequence of pulses until PFM Comparator will be triggered by rising output voltage.

Load Disconnection Function, Bypass Mode

When the CE pin is in a logic LOW state, the IXD2140 enters into standby mode and stops circuits required for the boost operation.

In the standby mode, the IXD2140A turns off both the N- and P-channel transistors, which cuts off the path for current between L_X and V_{OUT} pins, disconnecting load from voltage source. The parasitic diode control circuit connects the cathode of parasitic P-channel synchronous rectifier transistor's diode to the L_X pin, preventing current flow into the load (See figure 1).

In the standby mode, the IXD2140C version turns the N-channel transistor off, but the P-channel synchronous rectifier transistor remains on, when $V_{LX} > V_{OUT}$, and the parasitic diode control circuit connects the cathode of parasitic P-channel synchronous rectifier transistor's diode to the V_{OUT} pin (See figure 2). If $V_{LX} < V_{OUT}$, the P channel synchronous rectifier transistor is OFF and the parasitic diode cathode connected to the V_{OUT} pin prevents C_L to discharge into V_{BAT} source. However, during initial $\sim 500 \mu s$ after power up, the IXD2140C parasitic diode is connected as shown at figure 1, even if CE pin is logic LOW. After that, normal operations start.



$V_{BAT} - V_{OUT}$ Voltage Detection Circuit

The $V_{BAT} - V_{OUT}$ Voltage Detection Circuit compares the V_{BAT} pin voltage with the V_{OUT} pin voltage, and whichever is the highest used as the IC power supply (V_{DD}).

In addition, if, during normal operation, the input voltage becomes higher than the output voltage, the PFM Controller turns N-channel transistor off and the P-channel synchronous rectifier transistor on so that the input

voltage passes through to the output. When the input voltage becomes lower than the output voltage, the circuit automatically returns to the normal boost operation. This detection circuit does not operate in the standby mode in IXD2140A version.

Inrush Current Protection Circuitry

This circuitry limits inrush current from the V_{LX} pin to the V_{OUT} pin, charging C_L capacitor with stable current after V_{BAT} voltage applied, until V_{OUT} voltage reaches close to V_{BAT} . After that, Inrush Current Protection circuitry disables with several hundred μs ~ several ms delay time, and the IC becomes operational.

The IXD2140C starts Inrush Current protection $\sim 500 \mu s$ after power up disregard to CE pin logic state and the IXD2140A version starts Inrush Current protection only after CE pin is set logic High.

Inrush Current Protection Characteristics shown below.

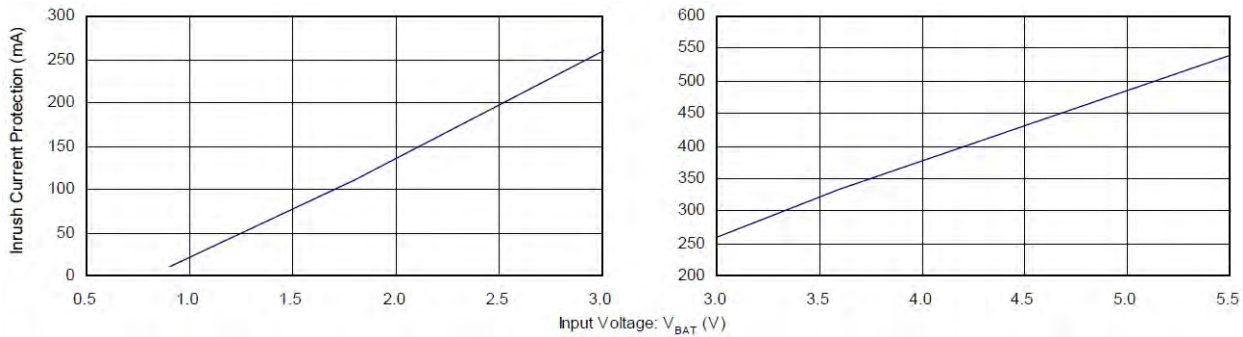

$L = 4.7 \mu H$ (VLF302512M-4R7M), $C_{IN} = 4.7 \mu F$ (LMK107BJ475MA), $C_L = 10 \mu F$ (LMK107BJ106MA), $I_{OUT} = 1 mA$, $T_a = 25^{\circ}C$

UVLO

This function is under development now.

C_L Discharge Function

This function is under development now.

TYPICAL APPLICATION CIRCUIT

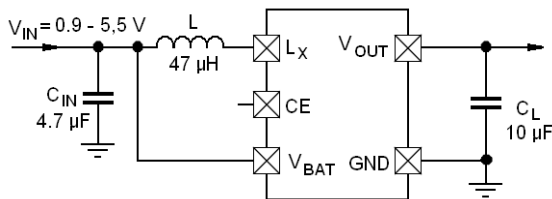

EXTERNAL COMPONENTS

COMPONENT	VALUE	MANUFACTURER	PRODUCT NUMBER
L	4.7 μH	TDK	VLF302512M-4R7
C_{IN}	4.7 μF	TAIYO YUDEN	LMK107BJ475MA
C_L	10 μF	TAIYO YUDEN	LMK107BJ106MA

Note:

1. Recommended Inductor's value is 4.7 μH ; however, inductors from 4.7 μH to 10.0 μH can be used.
2. The ripple voltage will increase if tantalum or electrolytic capacitors with high ESR are used as the load capacitor C_L . The operation could also become unstable, so carefully check this in the actual product.

LAYOUT AND USE CONSIDERATIONS

1. Do not exceed the value of stated absolute maximum ratings.
2. The IXD2140 performance is greatly influenced by not only the ICs' characteristics, but also by those of the external components. Care must be taken when selecting external components.
3. Ensure that the PCB ground traces are as thick as possible, as variations in ground potential caused by high ground currents at the time of switching may result in instability of the IC.
4. Mount each external component as close to the IC as possible and use thick, short connecting traces to reduce the circuit impedance.
5. An excessive current larger than the I_{PFM} flowing in the N- or P-channel transistors could destroy the IC.
6. In the bypass mode, the internal P-channel synchronous rectifier transistor is in on state to allow current flow between L_X and V_{OUT} pins. However, an excessive current could destroy the P-channel synchronous rectifier transistor.
7. The CE pin does not have an internal pull-up or pull-down resistors, so, do not left this pin open.
8. The IXD2140 is optimized for 4.7 μH inductor; however, inductors in the range from 4.7 to 10 μH can be used. If inductors above 4.7 μH , but in this range, will be used, we recommend evaluate them before use in final product.
9. At high temperatures, the product performance could vary causing the efficiency to decline. Evaluate this carefully, if the product will be used at high temperatures.
10. Note that the standby leakage current of the P-channel synchronous rectifier transistor at high-temperature operations could charge C_L capacitor, increasing output voltage of the IXD2140A.
11. The output voltage ripple effect from the load current causes the average output voltage to fluctuate, so carefully evaluate this in the actual product before use.
12. When the IXD2140 is activated at low input voltage, it may operate at discontinues conduction mode until the output voltage reaches about 1.7 V. The burst mode operations stats after that (See the figure below.)

$V_{BAT} = V_{CE} = 0 \rightarrow 0.9\text{ V}$, $V_{OUT} = 1.8\text{ V}$, $I_{OUT} = 1\text{ mA}$, $L = 4.7\ \mu\text{H}$, $C_L = 10\ \mu\text{F}$, $T_a = 25^\circ\text{C}$

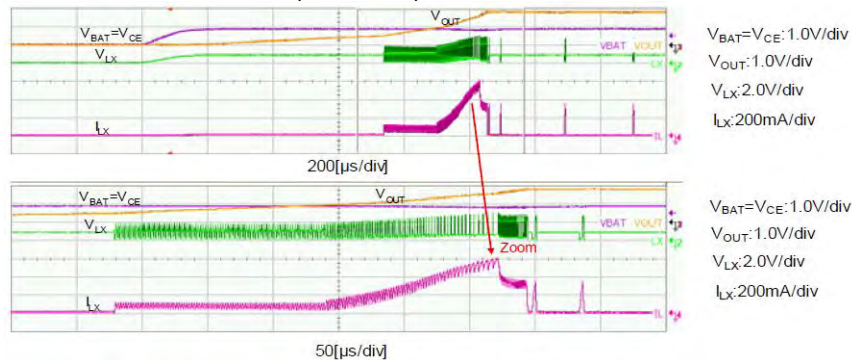

$V_{BAT} = V_{CE} = 0 \rightarrow 1.7\text{ V}$, $V_{OUT} = 1.8\text{ V}$, $I_{OUT} = 1\text{ mA}$, $L = 4.7\ \mu\text{H}$, $C_L = 10\ \mu\text{F}$, $T_a = 25^\circ\text{C}$

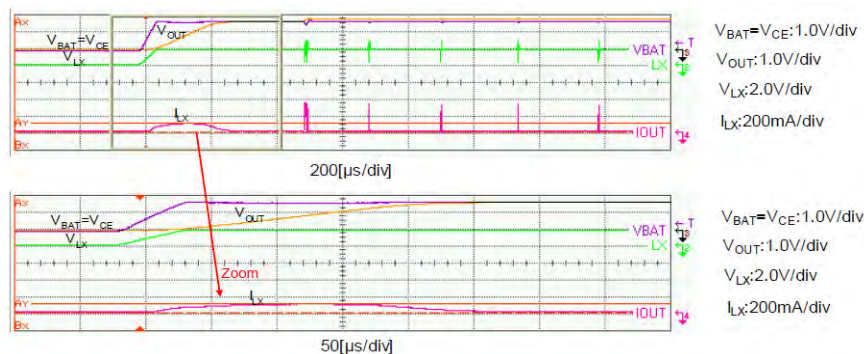

13. If the C_L capacitance or load current is excessively high, start-up time during which the IXD2140 operates in discontinues conduction mode will increase.
14. If after start-up the input voltage is higher than the output voltage due high load, then the circuit automatically enters mode with L_X pin connected to V_{OUT} pin through P-channel transistor in ON state. When the input

voltage becomes equal output voltage, normal operation restores, but repeated switching between modes may cause the ripple voltage fluctuate. (Refer to the graphic below).

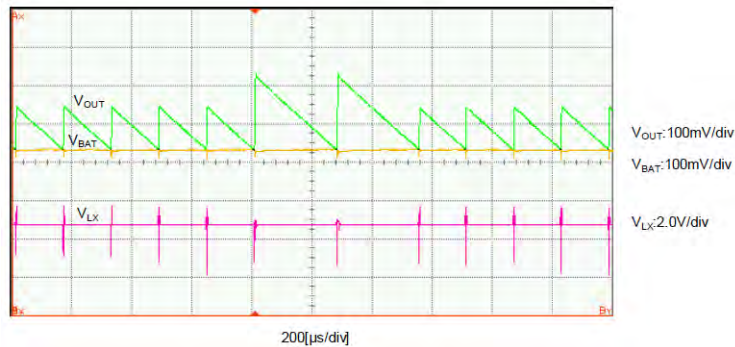

15. If another power supply is connected to the IXD2140A/IXD2140C V_{OUT} pin, the IC could be destroyed.
16. Transitional voltage drop or rise should not exceed IC limits to prevent its damage
17. The IXD2140A version may not start operate properly, if load current exceeds inrush current limit and output voltage does not rise above $V_{BAT} - 0.35\text{ V}$. Also at this condition, the IXD2140C version bypass mode will not operate too.

TEST CIRCUITS

Circuit ①

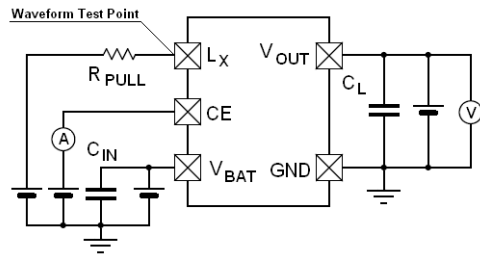

Circuit ⑤

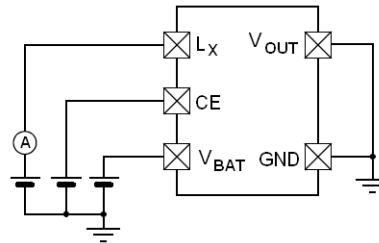

Circuit ②

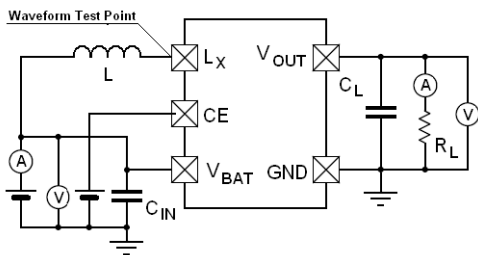

Circuit ⑥

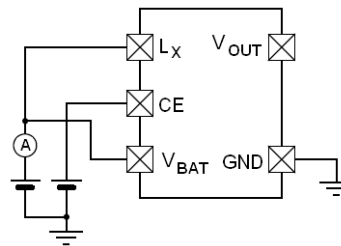

Circuit ③

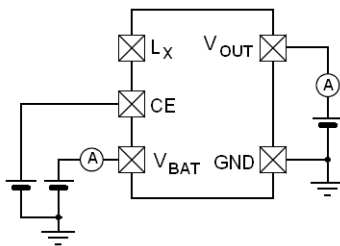

Circuit ⑦

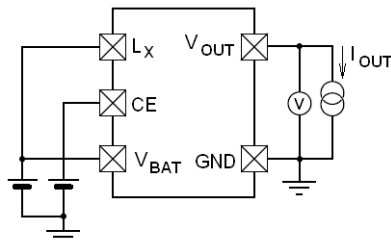

Circuit ④

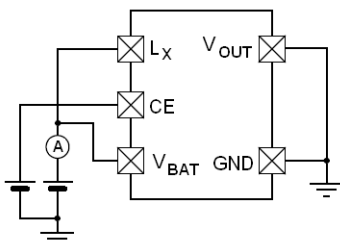

Circuit ⑧

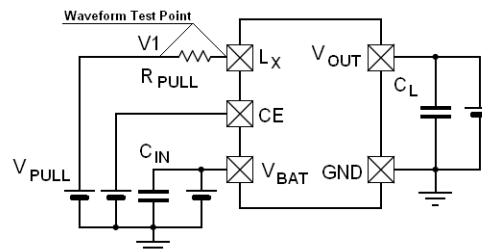

External Components, where applicable

$C_{IN} = 4.7 \mu\text{F}$, (ceramic)

$L = 4.7 \mu\text{H}$,

$C_L = 10 \mu\text{F}$, (ceramic)

Circuit ①

$R_{PULL} = 100 \Omega$

Circuit ⑧

$R_{PULL} = 4.7 \Omega$

Circuit ⑧: Lx N-channel transistor ON Resistance Measurement

Adjust V_{PULL} until L_x pin voltage becomes 100 mV, when the N-channel transistor is ON, and measure $V1$ voltage.

$$R_{LXN} = \frac{V_{LX}}{V1 - V_{LX}} * R_{PULL} = \frac{0.1}{V1 - 0.1} * 4.7, \Omega$$

Use an oscilloscope or other instrument to measure the L_x and $V1$ voltage.

TYPICAL PERFORMANCE CHARACTERISTICS

(1) Efficiency vs. Output Current

Topr = 25 °C

IXD2140A331MR-G (V_{OUT} = 3.3 V)

L = 4.7 μH (VLF302512M-4R7M), C_{IN} = 4.7 μF (LMK107BJ475MA), C_L = 10 μF (LMK107BJ106MA)

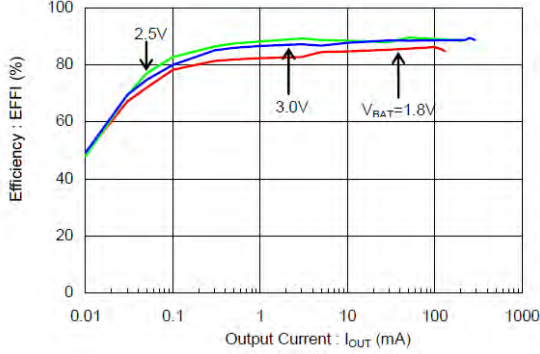

IXD2140A331MR-G (V_{OUT} = 3.3 V)

L = 10 μH (VLF302512M-4R7M), C_{IN} = 4.7 μF (LMK107BJ475MA), C_L = 10 μF (LMK107BJ106MA)

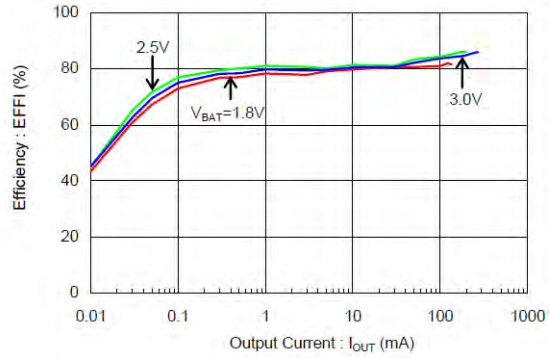

IXD2140A501MR-G (V_{OUT} = 5.0 V)

L = 4.7 μH (VLF302512M-4R7M), C_{IN} = 4.7 μF (LMK107BJ475MA), C_L = 10 μF (LMK107BJ106MA)

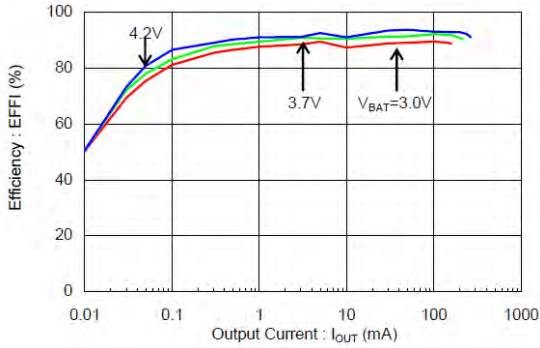

IXD2140A501MR-G (V_{OUT} = 5.0 V)

L = 10 μH (VLF302512M-4R7M), C_{IN} = 4.7 μF (LMK107BJ475MA), C_L = 10 μF (LMK107BJ106MA)

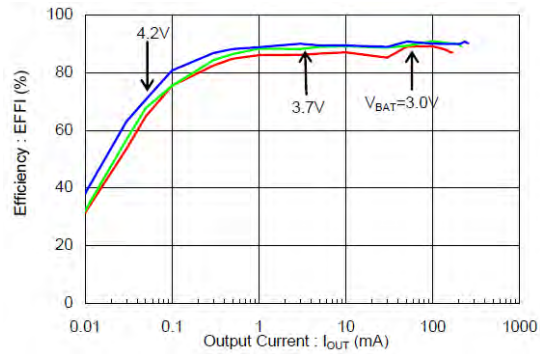

(2) Output Voltage vs. Output Current

IXD2140A331MR-G (V_{OUT} = 3.3 V)

L = 4.7 μH (VLF302512M-4R7M), C_{IN} = 4.7 μF (LMK107BJ475MA), C_L = 10 μF (LMK107BJ106MA)

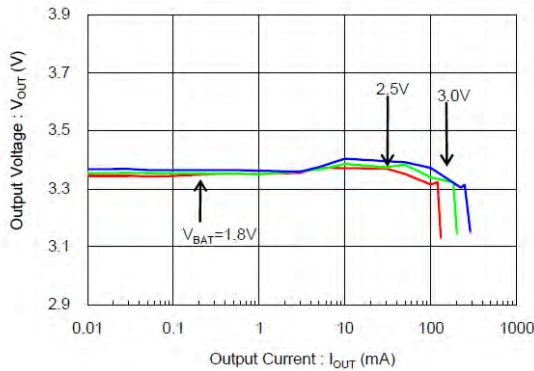

IXD2140A331MR-G (V_{OUT} = 3.3 V)

L = 10 μH (VLF302512M-4R7M), C_{IN} = 4.7 μF (LMK107BJ475MA), C_L = 10 μF (LMK107BJ106MA)

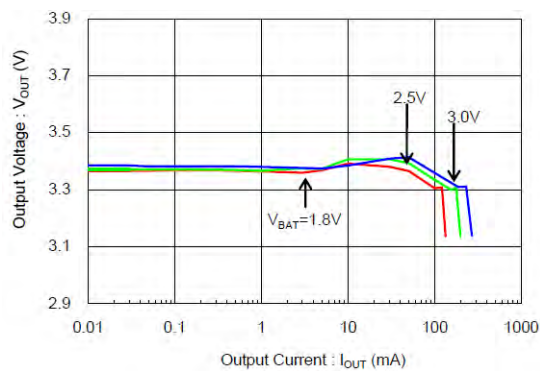

TYPICAL PERFORMANCE CHARACTERISTICS (Continued)

(2) Output Voltage vs. Output Current

Topr = 25 °C

IXD2140A501MR-G (V_{OUT} = 5.0 V)

L = 4.7 μH (VLF302512M-4R7M), C_N = 4.7 μF (LMK107BJ475MA), C_L = 10 μF (LMK107BJ106MA)

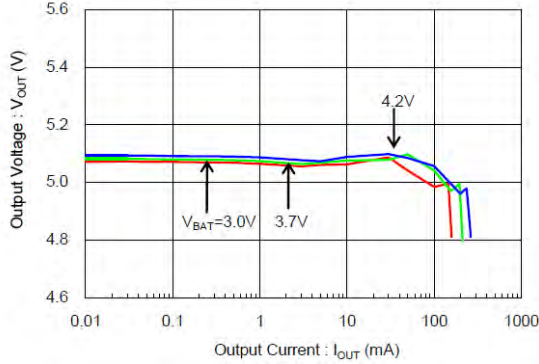

IXD2140A501MR-G (V_{OUT} = 5.0 V)

L = 10 μH (VLF302512M-4R7M), C_N = 4.7 μF (LMK107BJ475MA), C_L = 10 μF (LMK107BJ106MA)

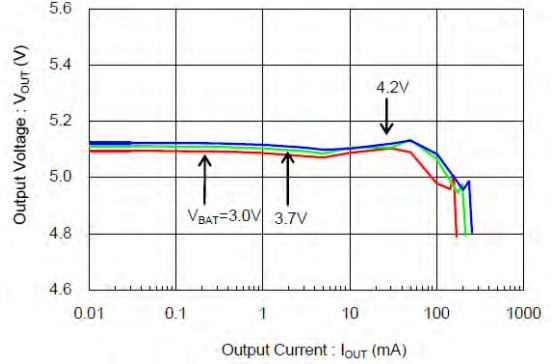

(3) Ripple Voltage vs. Output Current

IXD2140A331MR-G (V_{OUT} = 3.3 V)

L = 4.7 μH (VLF302512M-4R7M), C_N = 4.7 μF (LMK107BJ475MA), C_L = 10 μF (LMK107BJ106MA)

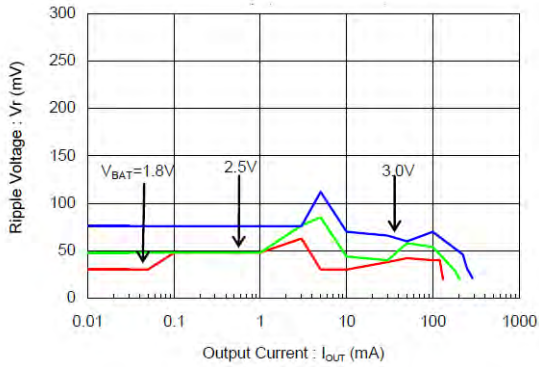

IXD2140A331MR-G (V_{OUT} = 3.3 V)

L = 10 μH (VLF302512M-4R7M), C_N = 4.7 μF (LMK107BJ475MA), C_L = 10 μF (LMK107BJ106MA)

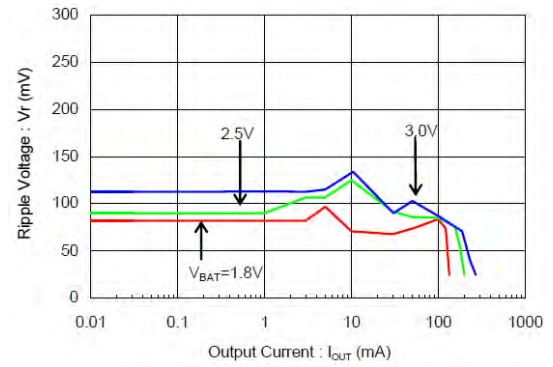

IXD2140A501MR-G (V_{OUT} = 5.0 V)

L = 4.7 μH (VLF302512M-4R7M), C_N = 4.7 μF (LMK107BJ475MA), C_L = 10 μF (LMK107BJ106MA)

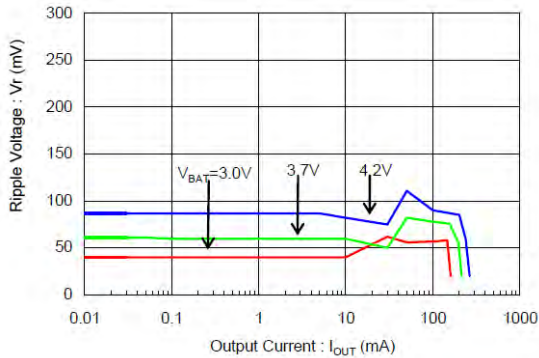

IXD2140A501MR-G (V_{OUT} = 5.0 V)

L = 10 μH (VLF302512M-4R7M), C_N = 4.7 μF (LMK107BJ475MA), C_L = 10 μF (LMK107BJ106MA)

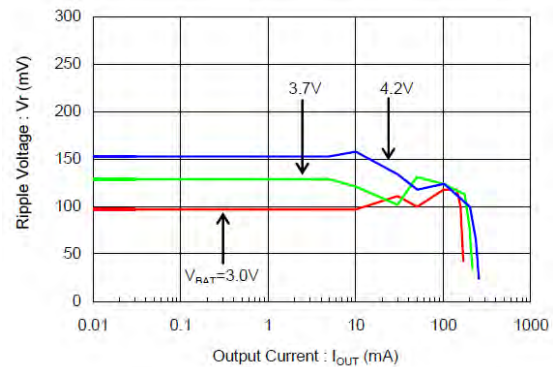

TYPICAL PERFORMANCE CHARACTERISTICS (Continued)

(4) Output Voltage vs. Ambient Temperature

$T_{opr} = 25\text{ }^{\circ}\text{C}$

IXD2140x33x ($V_{out} = 3.3\text{ V}$)

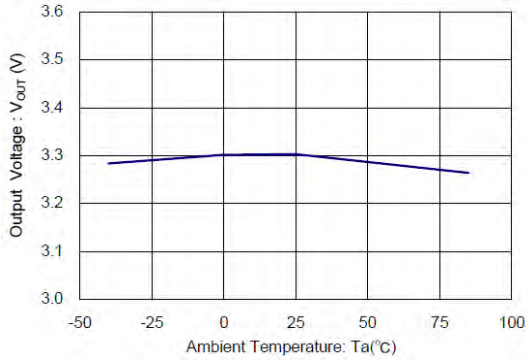

IXD2140x50x ($V_{out} = 5.0\text{ V}$)

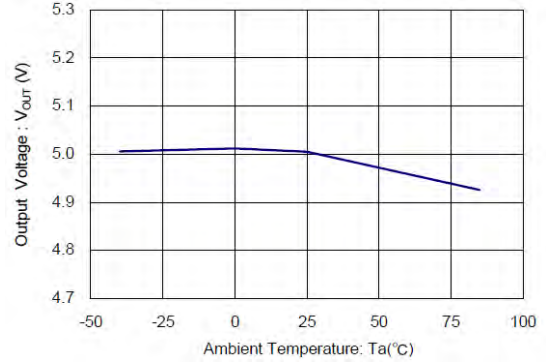

(5) Supply Current vs. Ambient Temperature

IXD2140xxx1

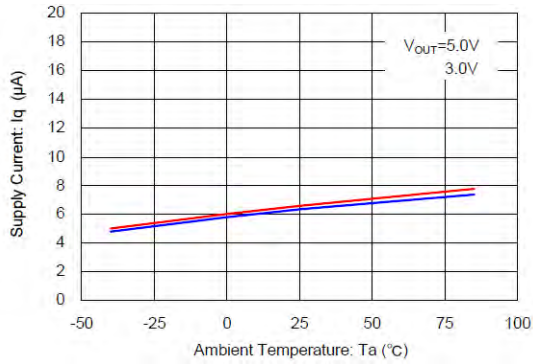

(6) Input Pin Current vs. Ambient Temperature

IXD2140xxx1

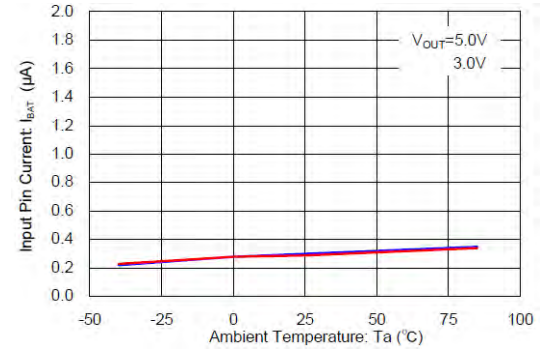

(7) Standby Current vs. Ambient Temperature

IXD2140A

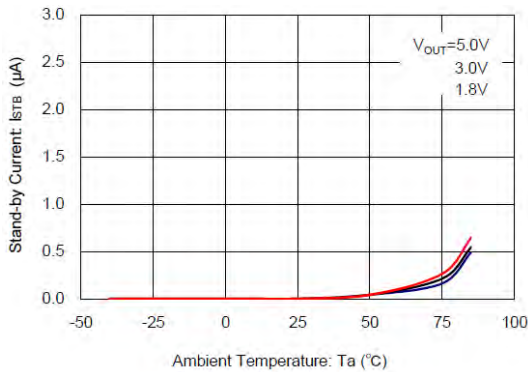

TYPICAL PERFORMANCE CHARACTERISTICS (Continued)

(8) Switching Current vs. Ambient Temperature

IXD2140

$L = 4.7 \mu\text{H}$ (VLF302512M-4R7M), $C_N = 4.7 \mu\text{F}$ (LMK107BJ475MA), $C_L = 10 \mu\text{F}$ (LMK107BJ106MA)

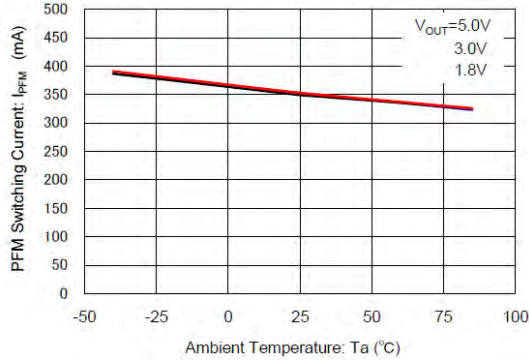

(9) Switching Current vs. Input Voltage

$T_{opr} = 25^\circ\text{C}$

IXD2140x50x

$L = 4.7 \mu\text{H}$ (VLF302512M-4R7M), $C_N = 4.7 \mu\text{F}$ (LMK107BJ475MA), $C_L = 10 \mu\text{F}$ (LMK107BJ106MA)

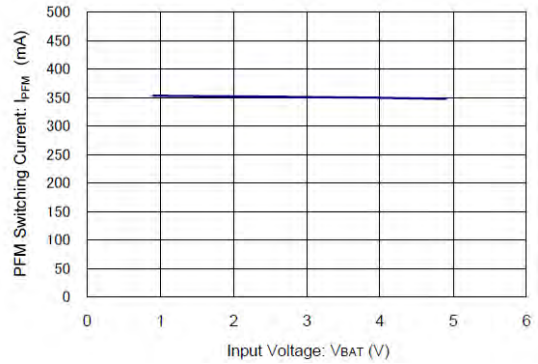

(10) Max ON Time vs. Ambient Temperature

IXD2140

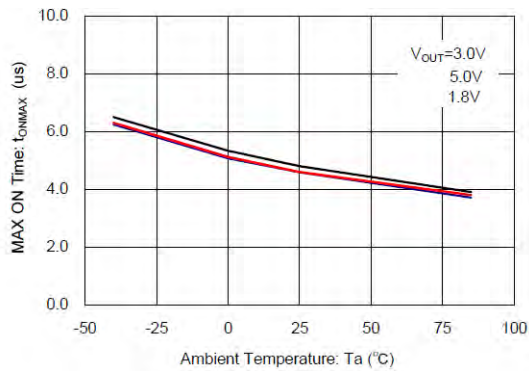

(11) Lx Switch N-Channel ON resistance vs. Output Voltage

IXD2140

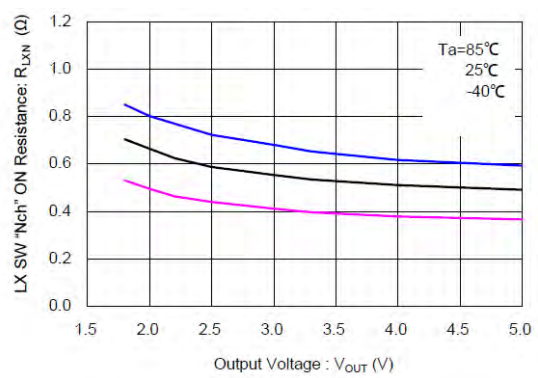

(12) Lx Switch P-Channel ON resistance vs. Output Voltage

IXD2140

$V_{BAT} = V_{LX} = V_{CE} = V_{OUT(E)} + 0.5 \text{ V}$, $I_{OUT} = 200 \text{ mA}$

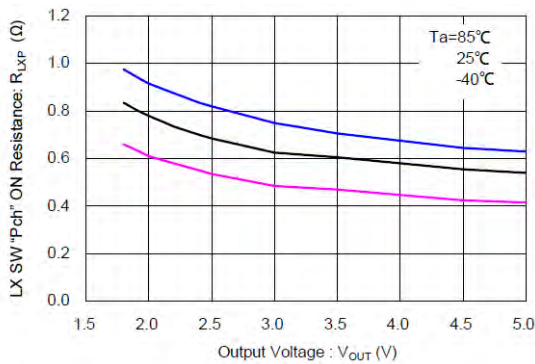

(13) Lx Leakage Current vs. Ambient Temperature

IXD2140A

$V_{BAT} = V_{LX} = V_{OUT(E)}$, $V_{OUT} = V_{CE} = 0 \text{ V}$

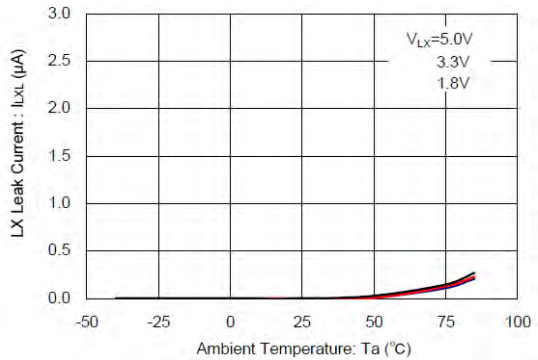

TYPICAL PERFORMANCE CHARACTERISTICS (Continued)

(14) CE "High" Voltage vs. Output Voltage

IXD2140

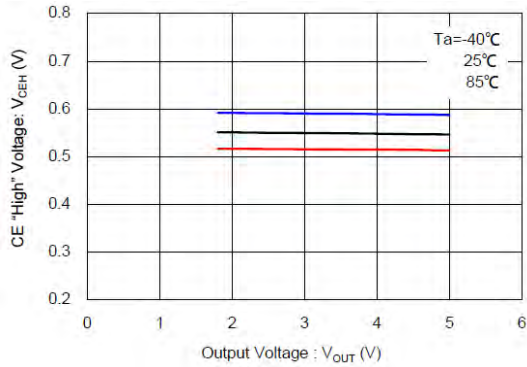

(15) CE "Low" Voltage vs. Output Voltage

IXD2140

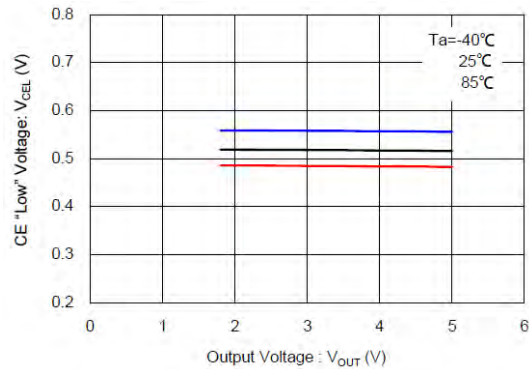

Topr = 25 °C

(16) Operation Start Voltage vs. Ambient Temperature

IXD2140 xxx1

L = 4.7 μH (VLF302512M-4R7M), C_N = 4.7 μF (LMK107BJ475MA), C_L = 10μF (LMK107BJ106MA)
R_L = V_{OUT(E)}/1 mA

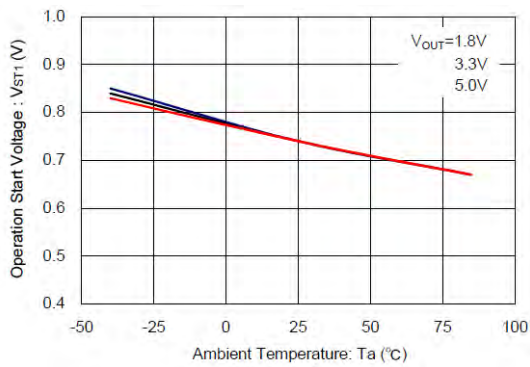

(17) Operation Stop Voltage vs. Ambient Temperature

IXD2140 xxx1

L = 4.7 μH (VLF302512M-4R7M), C_N = 4.7 μF (LMK107BJ475MA), C_L = 10μF (LMK107BJ106MA)
R_L = 1 kΩ

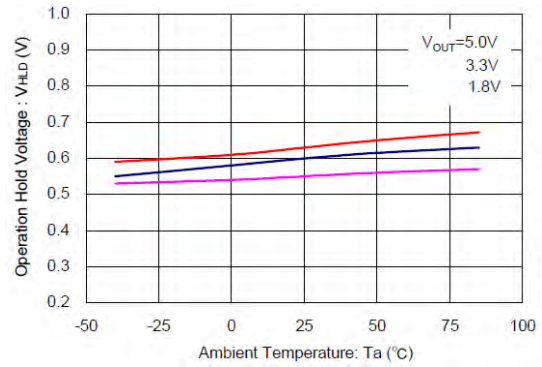

(18) Output Voltage V_{OUT} at Start-up

IXD2140x331

V_{OUT} = 3.3 V, V_{BAT} = V_{CE} = 0 → 1.8 V, R_L = 330 Ω

L = 4.7 μH (VLF302512M-4R7M), C_N = 4.7 μF (LMK107BJ475MA), C_L = 10μF (LMK107BJ106MA)

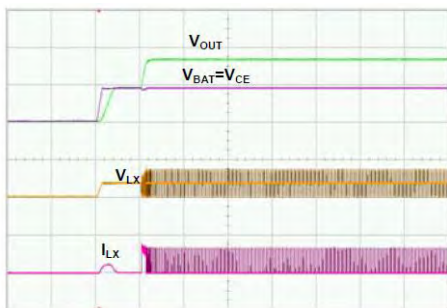

V_{OUT}:2 V/div, V_{BAT}:2 V/div, V_{LX}:5 V/div, I_{LX}:500 mA/div, Time: 500 μs/div

IXD2140x331

V_{OUT} = 3.3 V, V_{BAT} = V_{CE} = 0 → 1.8 V, R_L = 3300 Ω

L = 4.7 μH (VLF302512M-4R7M), C_N = 4.7 μF (LMK107BJ475MA), C_L = 10μF (LMK107BJ106MA)

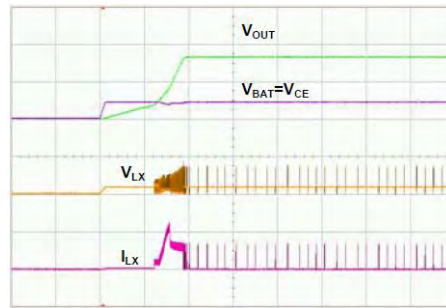

V_{OUT}:2 V/div, V_{BAT}:2 V/div, V_{LX}:5 V/div, I_{LX}:500 mA/div, Time: 500 μs/div

TYPICAL PERFORMANCE CHARACTERISTICS (Continued)

(18) Output Voltage V_{OUT} at Start-up (Continue)

$T_{opr} = 25^{\circ}C$

IXD2140x501

$V_{OUT} = 5.0 V$, $V_{BAT} = V_{CE} = 0 \rightarrow 3.3 V$, $R_L = 500 \Omega$
 $L = 4.7 \mu H$ (VLF302512M-4R7M), $C_N = 4.7 \mu F$ (LMK107BJ475MA), $C_L = 10 \mu F$ (LMK107BJ106MA)

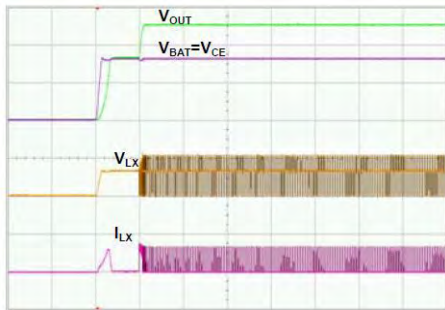

$V_{OUT}: 2 V/div$, $V_{BAT}: 2 V/div$, $V_{LX}: 5 V/div$, $I_{LX}: 500 mA/div$, Time: 500 $\mu s/div$

IXD2140x501

$V_{OUT} = 5.0 V$, $V_{BAT} = V_{CE} = 0 \rightarrow 5.5 V$, $R_L = 500 \Omega$
 $L = 4.7 \mu H$ (VLF302512M-4R7M), $C_N = 4.7 \mu F$ (LMK107BJ475MA), $C_L = 10 \mu F$ (LMK107BJ106MA)

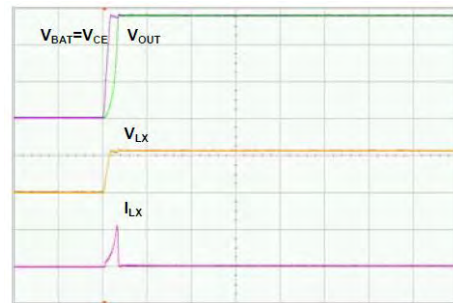

$V_{OUT}: 2 V/div$, $V_{BAT}: 2 V/div$, $V_{LX}: 5 V/div$, $I_{LX}: 500 mA/div$, Time: 500 $\mu s/div$

(19) Load Transient Response

IXD2140x181

$V_{OUT} = 1.8 V$, $V_{BAT} = V_{CE} = 0.9 V$, $I_{OUT} = 1 mA \rightarrow 25 mA$
 $L = 4.7 \mu H$ (VLF302512M-4R7M), $C_N = 4.7 \mu F$ (LMK107BJ475MA), $C_L = 10 \mu F$ (LMK107BJ106MA)

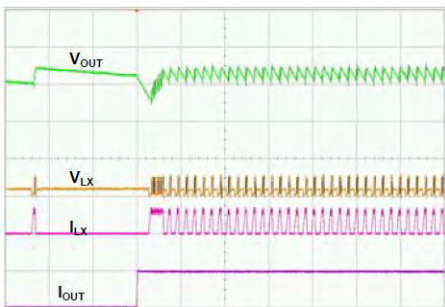

$V_{OUT}: 100 mV/div$, $V_{LX}: 5 V/div$, $I_{LX}: 500 mA/div$, $I_{OUT}: 25 mA/div$, Time: 50 $\mu s/div$

IXD2140x181

$V_{OUT} = 1.8 V$, $V_{BAT} = V_{CE} = 0.9 V$, $I_{OUT} = 25 mA \rightarrow 1 mA$
 $L = 4.7 \mu H$ (VLF302512M-4R7M), $C_N = 4.7 \mu F$ (LMK107BJ475MA), $C_L = 10 \mu F$ (LMK107BJ106MA)

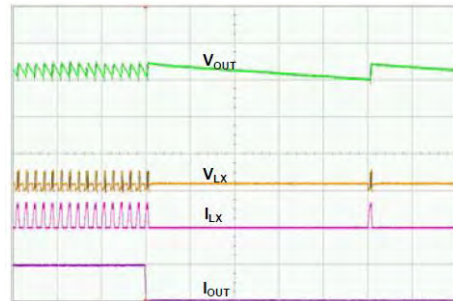

$V_{OUT}: 100 mV/div$, $V_{LX}: 5 V/div$, $I_{LX}: 500 mA/div$, $I_{OUT}: 25 mA/div$, Time: 50 $\mu s/div$

IXD2140x331

$V_{OUT} = 3.3 V$, $V_{BAT} = V_{CE} = 1.8 V$, $I_{OUT} = 1 mA \rightarrow 50 mA$
 $L = 4.7 \mu H$ (VLF302512M-4R7M), $C_N = 4.7 \mu F$ (LMK107BJ475MA), $C_L = 10 \mu F$ (LMK107BJ106MA)

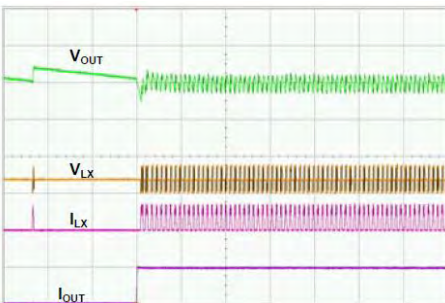

$V_{OUT}: 2 V/div$, $V_{BAT}: 2 V/div$, $V_{LX}: 5 V/div$, $I_{LX}: 500 mA/div$, Time: 500 $\mu s/div$

IXD2140x331

$V_{OUT} = 3.3 V$, $V_{BAT} = V_{CE} = 1.8 V$, $I_{OUT} = 50 mA \rightarrow 1 mA$
 $L = 4.7 \mu H$ (VLF302512M-4R7M), $C_N = 4.7 \mu F$ (LMK107BJ475MA), $C_L = 10 \mu F$ (LMK107BJ106MA)

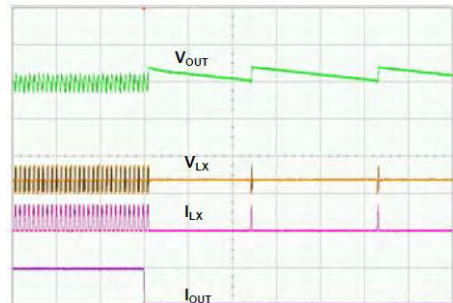

$V_{OUT}: 2 V/div$, $V_{BAT}: 2 V/div$, $V_{LX}: 5 V/div$, $I_{LX}: 500 mA/div$, Time: 500 $\mu s/div$

TYPICAL PERFORMANCE CHARACTERISTICS (Continued)

(19) Load Transient Response

Topr = 25 °C

IXD2140x501

$V_{OUT} = 5.0\text{ V}$, $V_{BAT} = V_{CE} = 3.7\text{ V}$, $I_{OUT} = 1\text{ mA} \rightarrow 100\text{ mA}$

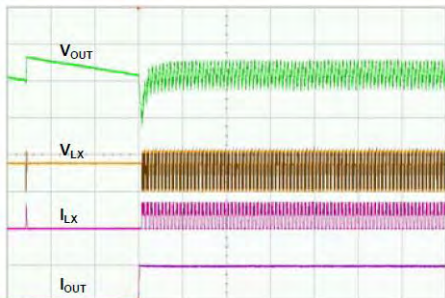

V_{OUT} :2 V/div, V_{BAT} :2 V/div, V_{LX} :5 V/div, I_{LX} : 500 mA/div, Time:500 μs/div

IXD2140x501

$V_{OUT} = 5.0\text{ V}$, $V_{BAT} = V_{CE} = 3.7\text{ V}$, $I_{OUT} = 100\text{ mA} \rightarrow 1\text{ mA}$

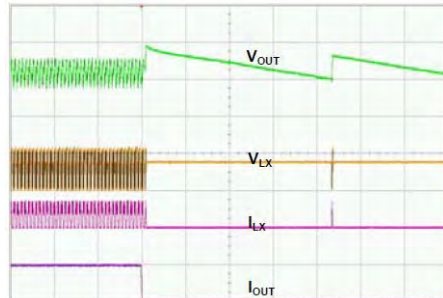

V_{OUT} :2 V/div, V_{BAT} :2 V/div, V_{LX} :5 V/div, I_{LX} : 500 mA/div, Time:500 μs/div

ORDERING INFORMATION

IXD2140①②③④⑤⑥⑦

DESIGNATOR	DESCRIPTION	SYMBOL	DESCRIPTION
① ¹⁾	Product Type	A	Load Disconnection Without C_L Auto Discharge
		C	V_{BAT} Bypass Without C_L Auto Discharge
②③ ²⁾	Output Voltage	18 ~ 50	example 3.3 V output - ② = 3, ③ = 3
④	UVLO Function	1	No UVLO
		2	$V_{UVLO} = 2.15\text{ V}$ (Under development)
⑤⑥-⑦ ³⁾	Packages (Order Limit)	MR-G	SOT-25 (3,000/Reel)
		4R-G	USP-6EL (3,000/Reel)

Note:

- 1) The product with the C_L discharge function is a semi-custom product.
- 2) $V_{OUT} = 3.3\text{ V}$ is a standard value
- 3) The "-G" suffix denotes halogen and antimony free, as well as being fully ROHS compliant.

PACKAGE DRAWING AND DIMENSIONS

Units: mm

SOT-25

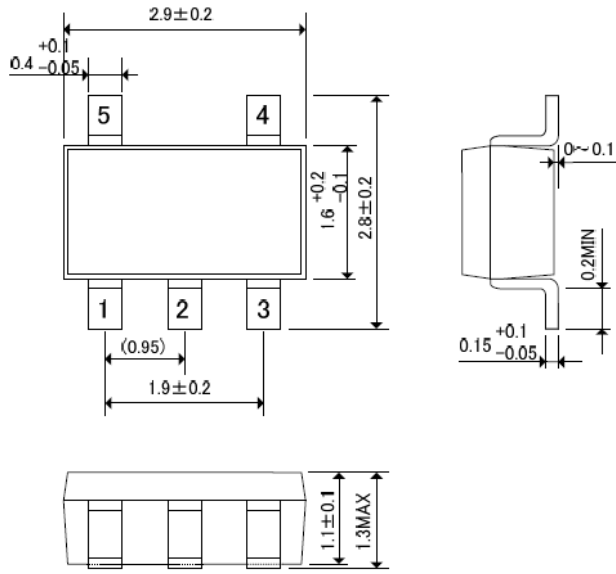

USP-6EL

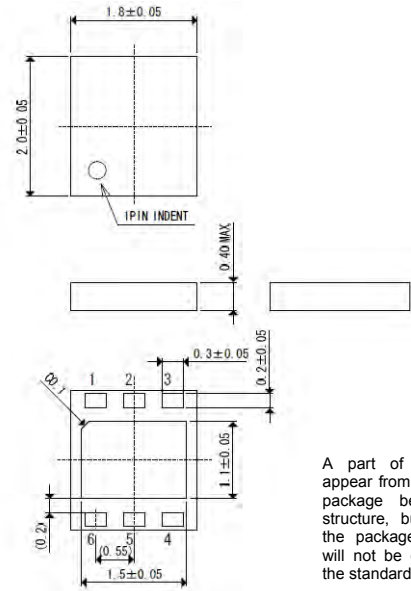

A part of the pin may appear from the side of the package because of its structure, but reliability of the package and strength will not be changed below the standard.

USP-6EL Reference Pattern Layout

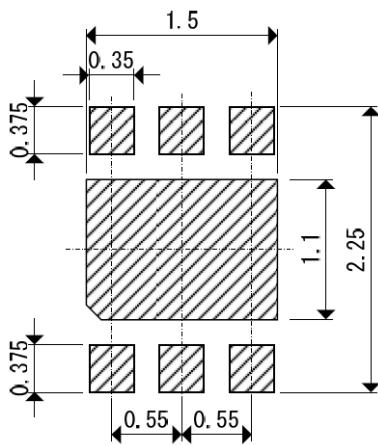

USP-6EL Reference Metal Mask Design

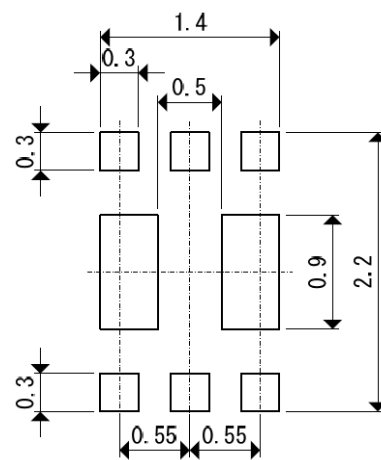

MARKING

SOT-25

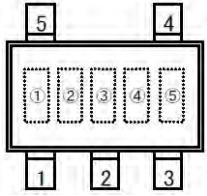

① represents product series

MARK	PRODUCT SERIES
4	IXD2140Axx1xx-G
	IXD2140Cxx1xx-G

② represents output voltage

USP-6EL

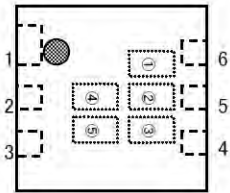

MARK	OUTPUT VOLTAGE		MARK	OUTPUT VOLTAGE	
0	1.8	3.5	9	2.7	4.4
1	1.9	3.6	A	2.8	4.5
2	2.0	3.7	B	2.9	4.6
3	2.1	3.8	C	3.0	4.7
4	2.2	3.9	D	3.1	4.8
5	2.3	4.0	E	3.2	4.9
6	2.4	4.1	F	3.3	5.0
7	2.5	4.2	H	3.4	
8	2.6	4.3			

③ represents product function

MARK	OUTPUT VOLTAGE	PRODUCT SERIES
N	1.8 – 3.4 V	IXD2140Axx1xx-G
P	3.5 – 5.0 V	
T	1.8 – 3.4 V	IXD2140Cxx1xx-G
U	3.5 – 5.0 V	

④⑤ represents production lot number 01~09, 0A~0Z, 11~9Z, A1~A9, AA~AZ, B1~ZZ in order.
(G, I, J, O, Q, W excluded)