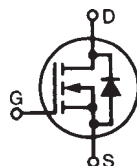


# Polar™ Power MOSFET

## HiPerFET™

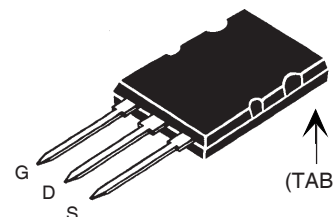
# IXFB40N110P

N-Channel Enhancement Mode  
Avalanche Rated  
Fast Intrinsic Diode



$V_{DSS} = 1100V$   
 $I_{D25} = 40A$   
 $R_{DS(on)} \leq 260m\Omega$   
 $t_{rr} \leq 300ns$

PLUS264™ (IXFB)



G = Gate      D = Drain  
S = Source      TAB = Drain

Symbol	Test Conditions	Maximum Ratings	
$V_{DSS}$	$T_J = 25^\circ C$ to $150^\circ C$	1100	V
$V_{DGR}$	$T_J = 25^\circ C$ to $150^\circ C$ , $R_{GS} = 1M\Omega$	1100	V
$V_{GSS}$	Continuous	$\pm 30$	V
$V_{GSM}$	Transient	$\pm 40$	V
$I_{D25}$	$T_C = 25^\circ C$	40	A
$I_{DM}$	$T_C = 25^\circ C$ , pulse width limited by $T_{JM}$	100	A
$I_{AR}$	$T_C = 25^\circ C$	20	A
$E_{AS}$	$T_C = 25^\circ C$	2	J
$dV/dt$	$I_S \leq I_{DM}$ , $V_{DD} \leq V_{DSS}$ , $T_J \leq 150^\circ C$	15	V/ns
$P_D$	$T_C = 25^\circ C$	1250	W
$T_J$		-55 ... +150	$^\circ C$
$T_{JM}$		150	$^\circ C$
$T_{stg}$		-55 ... +150	$^\circ C$
$T_L$	1.6mm (0.062 in.) from case for 10s	300	$^\circ C$
$T_{SOLD}$	Plastic body for 10s	260	$^\circ C$
$F_C$	Mounting force	30..120/6.7..27	N/lb.
<b>Weight</b>		10	g

### Features

- Fast recovery diode
- Unclamped Inductive Switching (UIS) rated
- Low package inductance
  - easy to drive and to protect

### Advantages

- Plus 264™ package for clip or spring mounting
- Space savings
- High power density

### Applications:

- High Voltage Switched-mode and resonant-mode power supplies
- High Voltage Pulse Power Applications
- High Voltage Discharge circuits in Lasers Pulsers, Spark Igniters, RF Generators
- High Voltage DC-DC converters
- High Voltage DC-AC inverters

Symbol	Test Conditions	Characteristic Values		
		Min.	Typ.	Max.
$BV_{DSS}$	$V_{GS} = 0V$ , $I_D = 3mA$	1100		V
$V_{GS(th)}$	$V_{DS} = V_{GS}$ , $I_D = 1mA$	3.5		6.5 V
$I_{GSS}$	$V_{GS} = \pm 30V$ , $V_{DS} = 0V$			$\pm 200$ nA
$I_{DSS}$	$V_{DS} = V_{DSS}$ $V_{GS} = 0V$			50 $\mu A$ 3 mA
$R_{DS(on)}$	$V_{GS} = 10V$ , $I_D = 0.5 \cdot I_{D25}$ , Note 1			260 m $\Omega$

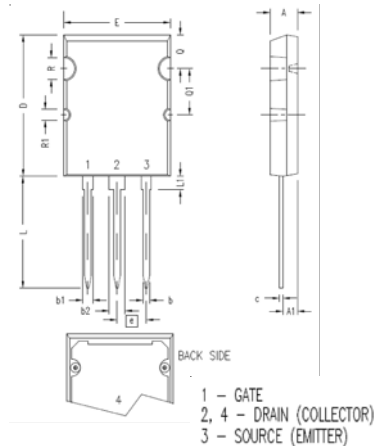
Symbol	Test Conditions	Characteristic Values		
		Min.	Typ.	Max.
$g_{fs}$	$V_{DS} = 20V, I_D = 0.5 \cdot I_{D25}$ , Note 1	20	32	S
$C_{iss}$	$V_{GS} = 0V, V_{DS} = 25V, f = 1MHz$		19	nF
$C_{oss}$			1070	pF
$C_{rss}$			46	pF
$R_{GI}$	Gate Input Resistance		1.65	$\Omega$
$t_{d(on)}$	<b>Resistive Switching Times</b> $V_{GS} = 10V, V_{DS} = 0.5 \cdot V_{DSS}, I_D = 0.5 \cdot I_{D25}$ $R_G = 1\Omega$ (External)		53	ns
$t_r$			55	ns
$t_{d(off)}$			110	ns
$t_f$			54	ns
$Q_{g(on)}$	$V_{GS} = 10V, V_{DS} = 0.5 \cdot V_{DSS}, I_D = 0.5 \cdot I_{D25}$		310	nC
$Q_{gs}$			95	nC
$Q_{gd}$			142	nC
$R_{thJC}$			0.10	$^{\circ}C/W$
$R_{thCS}$		0.13		$^{\circ}C/W$

**Source-Drain Diode**

**Characteristic Values**  
( $T_J = 25^{\circ}C$ , unless otherwise specified)

Symbol	Test Conditions	Characteristic Values		
		Min.	Typ.	Max.
$I_S$	$V_{GS} = 0V$			40 A
$I_{SM}$	Repetitive, pulse width limited by $T_{JM}$			160 A
$V_{SD}$	$I_F = I_S, V_{GS} = 0V$ , Note 1			1.5 V
$t_{rr}$	$I_F = 20A, -di/dt = 100A/\mu s$ $V_R = 100V, V_{GS} = 0V$			300 ns
$Q_{RM}$			2.2	$\mu C$
$I_{RM}$			16	A

Note 1: Pulse test,  $t \leq 300\mu s$ ; duty cycle,  $d \leq 2\%$ .

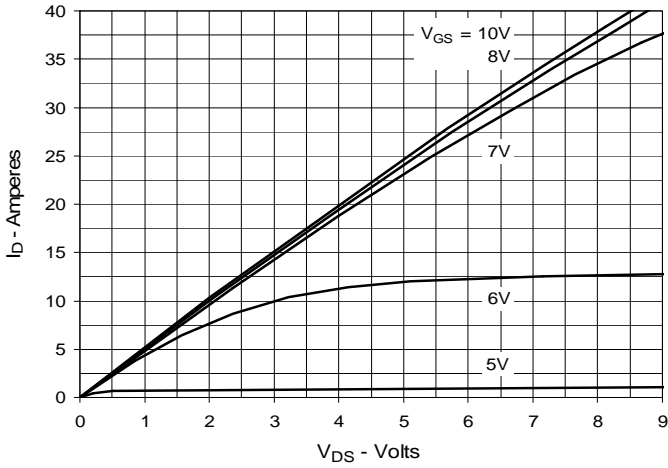
**PLUS264™ (IXFB) Outline**


SYM	INCHES		MILLIMETERS	
	MIN	MAX	MIN	MAX
A	.185	.209	4.70	5.31
A1	.102	.118	2.59	3.00
b	.037	.055	0.94	1.40
b1	.087	.102	2.21	2.59
b2	.110	.126	2.79	3.20
c	.017	.029	0.43	0.74
D	1.007	1.047	25.58	26.59
E	.760	.799	19.30	20.29
e	.215 BSC		5.46 BSC	
L	.779	.842	19.79	21.39
L1	.087	.102	2.21	2.59
Q	.240	.256	6.10	6.50
Q1	.330	.346	8.38	8.79
$\varnothing R$	.155	.187	3.94	4.75
$\varnothing R1$	.085	.093	2.16	2.36

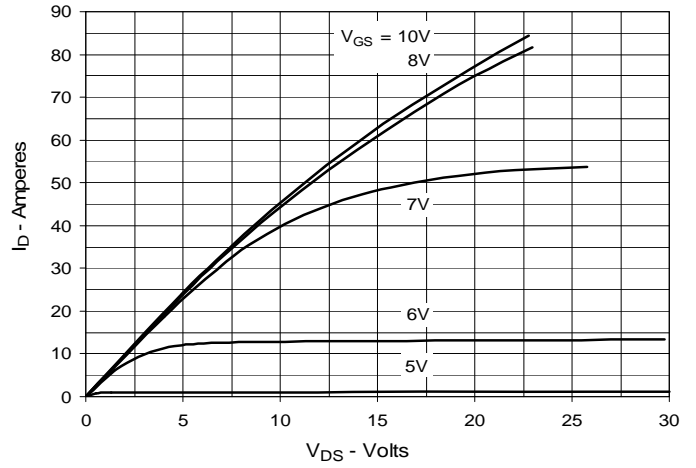
IXYS reserves the right to change limits, test conditions, and dimensions.

IXYS MOSFETs and IGBTs are covered by one or more of the following U.S. patents:	4,835,592	4,931,844	5,049,961	5,237,481	6,162,665	6,404,065 B1	6,683,344	6,727,585	7,005,734 B2	7,157,338B2
	4,850,072	5,017,508	5,063,307	5,381,025	6,259,123 B1	6,534,343	6,710,405 B2	6,759,692	7,063,975 B2	
	4,881,106	5,034,796	5,187,117	5,486,715	6,306,728 B1	6,583,505	6,710,463	6,771,478 B2	7,071,537	

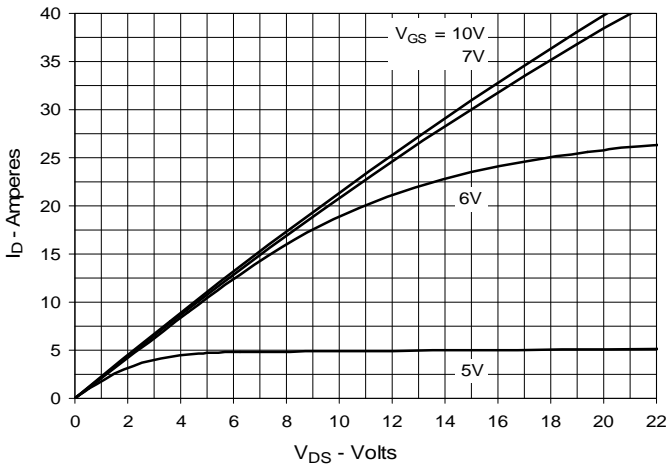
**Fig. 1. Output Characteristics @ 25°C**



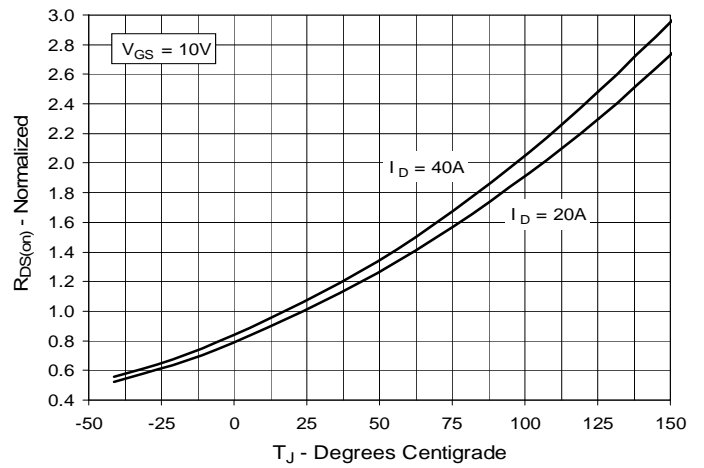
**Fig. 2. Extended Output Characteristics @ 25°C**



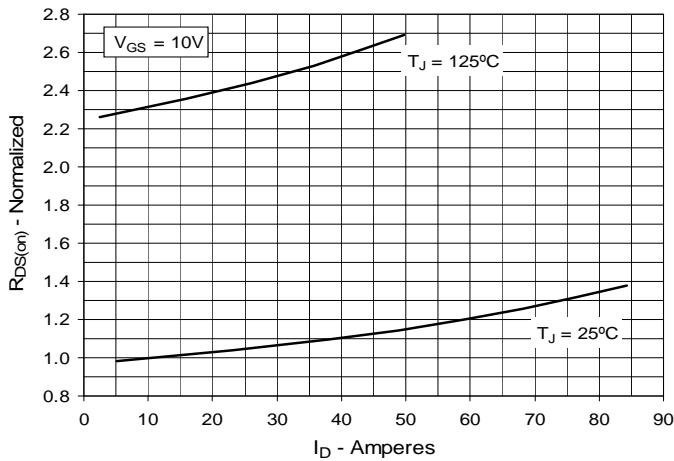
**Fig. 3. Output Characteristics @ 125°C**



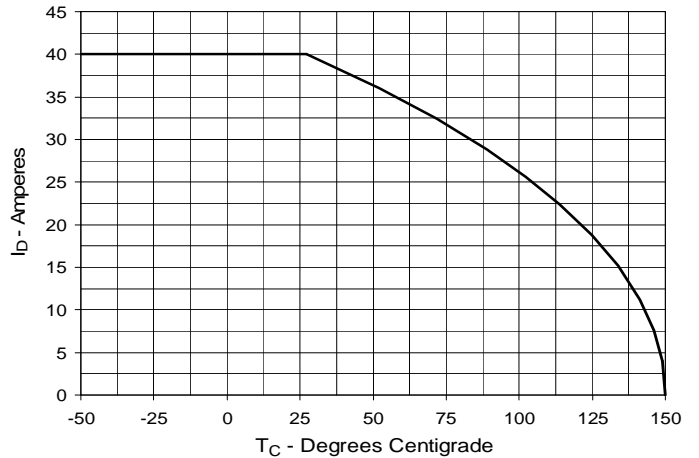
**Fig. 4.  $R_{DS(on)}$  Normalized to  $I_D = 20A$  Value vs. Junction Temperature**

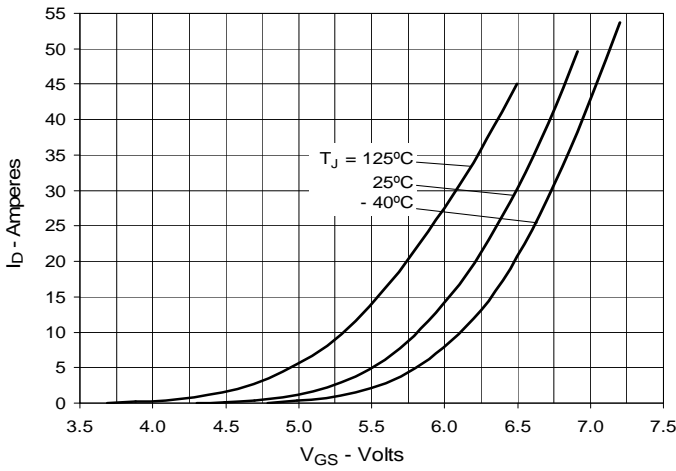
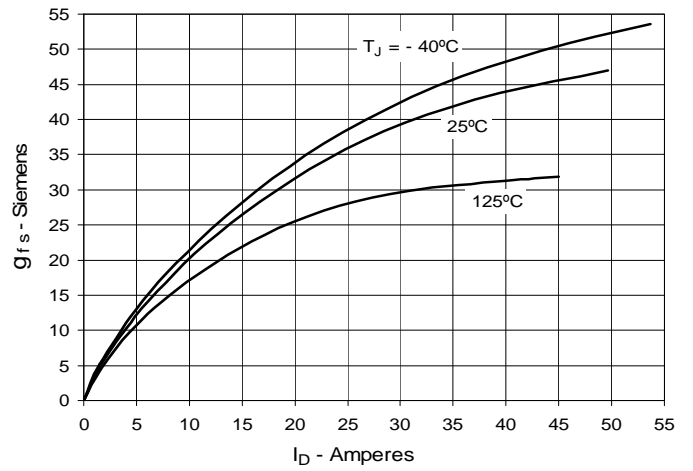
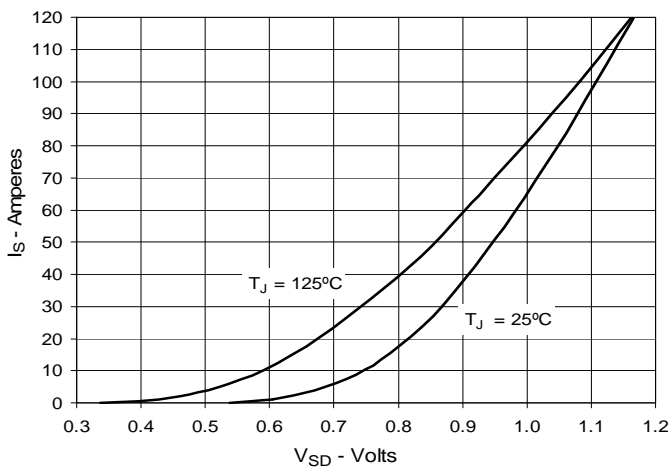
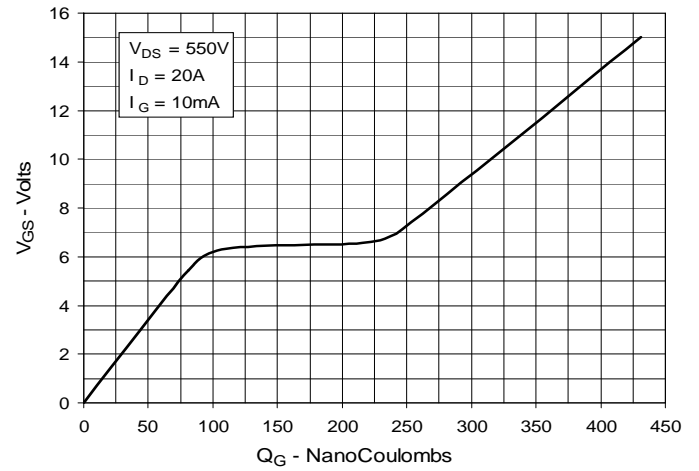
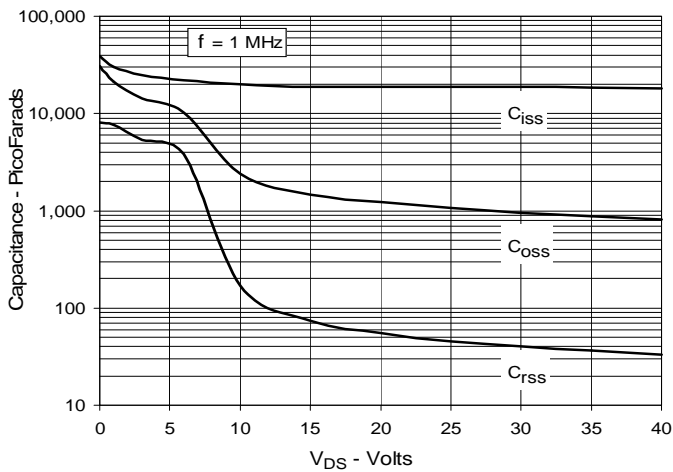
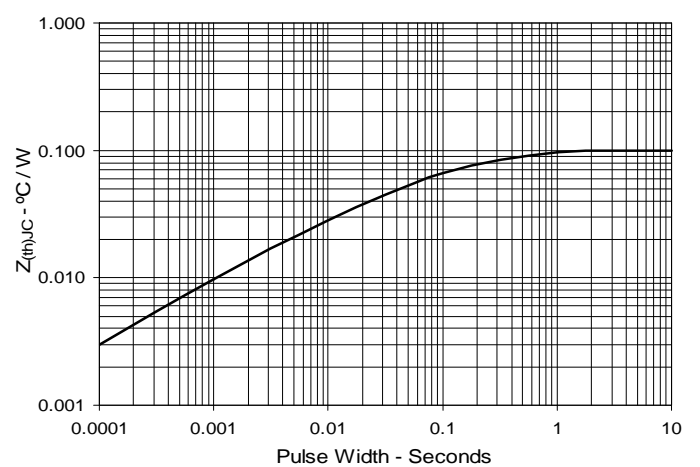


**Fig. 5.  $R_{DS(on)}$  Normalized to  $I_D = 20A$  Value vs. Drain Current**



**Fig. 6. Maximum Drain Current vs. Case Temperature**



**Fig. 7. Input Admittance**

**Fig. 8. Transconductance**

**Fig. 9. Forward Voltage Drop of Intrinsic Diode**

**Fig. 10. Gate Charge**

**Fig. 11. Capacitance**

**Fig. 12. Maximum Transient Thermal Impedance**


IXYS reserves the right to change limits, test conditions, and dimensions.