

### GenX3™ 600V IGBTs

### IXGK320N60B3 IXGX320N60B3

$$V_{CES} = 600V$$

$$I_{C90} = 320A$$

$$V_{CE(sat)} \leq 1.6V$$

Medium-Speed Low-Vsat PT  
IGBTs for 5-40 kHz Switching

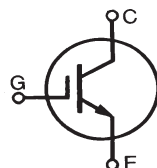

Symbol	Test Conditions	Maximum Ratings	
$V_{CES}$	$T_J = 25^\circ C$ to $150^\circ C$	600	V
$V_{CGR}$	$T_J = 25^\circ C$ to $150^\circ C$ , $R_{GE} = 1M\Omega$	600	V
$V_{GES}$	Continuous	$\pm 20$	V
$V_{GEM}$	Transient	$\pm 30$	V
$I_{C25}$	$T_C = 25^\circ C$ ( Chip Capability )	500	A
$I_{C90}$	$T_C = 90^\circ C$	320	A
$I_{LRMS}$	Terminal Current Limit	160	A
$I_{CM}$	$T_C = 25^\circ C$ , 1ms	1200	A
<b>SSOA</b>	$V_{GE} = 15V$ , $T_{VJ} = 125^\circ C$ , $R_G = 1\Omega$	$I_{CM} = 320$	A
<b>(RBSOA)</b>	Clamped Inductive Load	$V_{CE} \leq V_{CES}$	V
$P_C$	$T_C = 25^\circ C$	1700	W
$T_J$		-55 ... +150	$^\circ C$
$T_{JM}$		150	$^\circ C$
$T_{stg}$		-55 ... +150	$^\circ C$
$T_L$	Maximum Lead Temperature for Soldering	300	$^\circ C$
$T_{SOLD}$	1.6 mm (0.062 in.) from Case for 10	260	$^\circ C$
$M_d$	Mounting Torque ( IXGK )	1.13/10	Nm/lb.in.
$F_C$	Mounting Force ( IXGX )	20..120/4.5..27	N/lb.
<b>Weight</b>	TO-264	10	g
	PLUS247	6	g

TO-264 (IXGK)

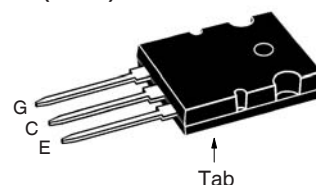

PLUS247 (IXGX)

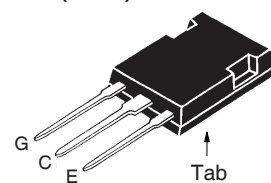

G = Gate                      E = Emitter  
C = Collector                Tab = Collector

### Features

- Optimized for Low Conduction and Switching Losses
- High Current Capability
- Square RBSOA

### Advantages

- High Power Density
- Low Gate Drive Requirement

### Applications

- Power Inverters
- UPS
- Motor Drives
- SMPS
- PFC Circuits
- Battery Chargers
- Welding Machines
- Lamp Ballasts

Symbol	Test Conditions ( $T_J = 25^\circ C$ , Unless Otherwise Specified)	Characteristic Values		
		Min.	Typ.	Max.
$BV_{CES}$	$I_C = 1mA$ , $V_{GE} = 0V$	600		V
$V_{GE(th)}$	$I_C = 4mA$ , $V_{CE} = V_{GE}$	3.0		5.0 V
$I_{CES}$	$V_{CE} = V_{CES}$ , $V_{GE} = 0V$ $T_J = 125^\circ C$			75 $\mu A$ 2 mA
$I_{GES}$	$V_{CE} = 0V$ , $V_{GE} = \pm 20V$			$\pm 400$ nA
$V_{CE(sat)}$	$I_C = 100A$ , $V_{GE} = 15V$ , Note 1 $I_C = 320A$		1.4 2.0	1.6 V V

Symbol	Test Conditions ( $T_J = 25^\circ\text{C}$ , Unless Otherwise Specified)	Characteristic Values		
		Min.	Typ.	Max.
$g_{fs}$	$I_C = 60\text{A}, V_{CE} = 10\text{V}$ , Note 1	70	125	S
$C_{ies}$ $C_{oes}$ $C_{res}$	$V_{CE} = 25\text{V}, V_{GE} = 0\text{V}, f = 1\text{MHz}$		18	nF
			960	pF
			130	pF
$Q_g$ $Q_{ge}$ $Q_{gc}$	$I_C = 320\text{A}, V_{GE} = 15\text{V}, V_{CE} = 0.5 \cdot V_{CES}$		585	nC
			105	nC
			215	nC
$t_{d(on)}$ $t_{ri}$ $E_{on}$ $t_{d(off)}$ $t_{fi}$ $E_{off}$	<b>Inductive Load, <math>T_J = 25^\circ\text{C}</math></b>  $I_C = 100\text{A}, V_{GE} = 15\text{V}$  $V_{CE} = 0.8 \cdot V_{CES}, R_G = 1\Omega$		44	ns
			66	ns
			2.7	mJ
			250	ns
			165	ns
			3.5	5.0
$t_{d(on)}$ $t_{ri}$ $E_{on}$ $t_{d(off)}$ $t_{fi}$ $E_{off}$	<b>Inductive Load, <math>T_J = 125^\circ\text{C}</math></b>  $I_C = 100\text{A}, V_{GE} = 15\text{V}$  $V_{CE} = 0.8 \cdot V_{CES}, R_G = 1\Omega$		40	ns
			67	ns
			3.5	mJ
			330	ns
			265	ns
			5.4	mJ
$R_{thJC}$ $R_{thCS}$		0.15	0.073	$^\circ\text{C/W}$ $^\circ\text{C/W}$

### TO-264 AA (IXGK) Outline

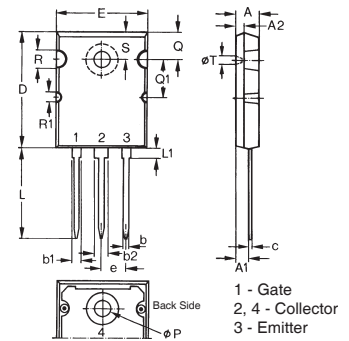

Dim.	Millimeter		Inches	
	Min.	Max.	Min.	Max.
A	4.82	5.13	.190	.202
A1	2.54	2.89	.100	.114
A2	2.00	2.10	.079	.083
b	1.12	1.42	.044	.056
b1	2.39	2.69	.094	.106
b2	2.90	3.09	.114	.122
c	0.53	0.83	.021	.033
D	25.91	26.16	1.020	1.030
E	19.81	19.96	.780	.786
e	5.46 BSC		.215 BSC	
J	0.00	0.25	.000	.010
K	0.00	0.25	.000	.010
L	20.32	20.83	.800	.820
L1	2.29	2.59	.090	.102
P	3.17	3.66	.125	.144
Q	6.07	6.27	.239	.247
Q1	8.38	8.69	.330	.342
R	3.81	4.32	.150	.170
R1	1.78	2.29	.070	.090
S	6.04	6.30	.238	.248
T	1.57	1.83	.062	.072

### PLUS247™ (IXGX) Outline

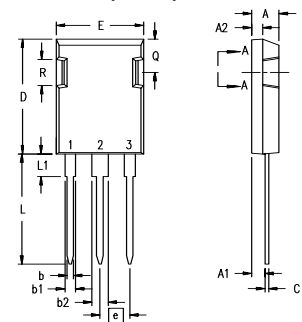

Terminals: 1 - Gate  
2 - Collector  
3 - Emitter

Dim.	Millimeter		Inches	
	Min.	Max.	Min.	Max.
A	4.83	5.21	.190	.205
A <sub>1</sub>	2.29	2.54	.090	.100
A <sub>2</sub>	1.91	2.16	.075	.085
b	1.14	1.40	.045	.055
b <sub>1</sub>	1.91	2.13	.075	.084
b <sub>2</sub>	2.92	3.12	.115	.123
C	0.61	0.80	.024	.031
D	20.80	21.34	.819	.840
E	15.75	16.13	.620	.635
e	5.45 BSC		.215 BSC	
L	19.81	20.32	.780	.800
L1	3.81	4.32	.150	.170
Q	5.59	6.20	.220	0.244
R	4.32	4.83	.170	.190

Note 1. Pulse test,  $t \leq 300\mu\text{s}$ , duty cycle,  $d \leq 2\%$ .

### PRELIMINARY TECHNICAL INFORMATION

The product presented herein is under development. The Technical Specifications offered are derived from data gathered during objective characterizations of preliminary engineering lots; but also may yet contain some information supplied during a pre-production design evaluation. IXYS reserves the right to change limits, test conditions, and dimensions without notice.

IXYS Reserves the Right to Change Limits, Test Conditions, and Dimensions.

IXYS MOSFETs and IGBTs are covered by one or more of the following U.S. patents:

4,835,592	4,931,844	5,049,961	5,237,481	6,162,665	6,404,065 B1	6,683,344	6,727,585	7,005,734 B2	7,157,338B2
4,850,072	5,017,508	5,063,307	5,381,025	6,259,123 B1	6,534,343	6,710,405 B2	6,759,692	7,063,975 B2	
4,881,106	5,034,796	5,187,117	5,486,715	6,306,728 B1	6,583,505	6,710,463	6,771,478 B2	7,071,537	

**Fig. 1. Output Characteristics @  $T_J = 25^\circ\text{C}$**

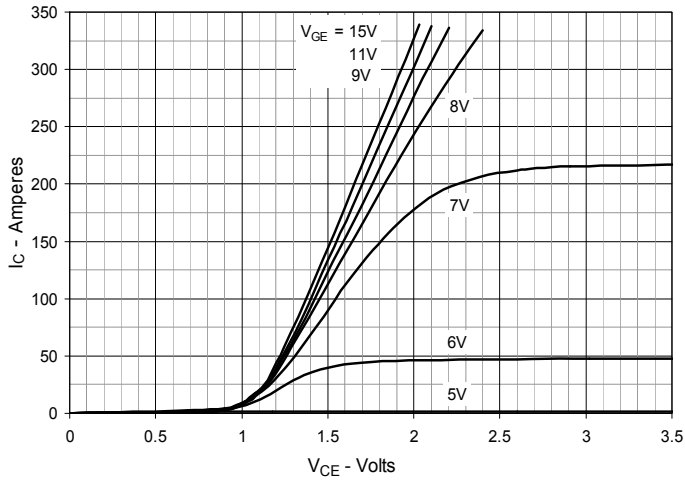

**Fig. 2. Output Characteristics @  $T_J = 125^\circ\text{C}$**

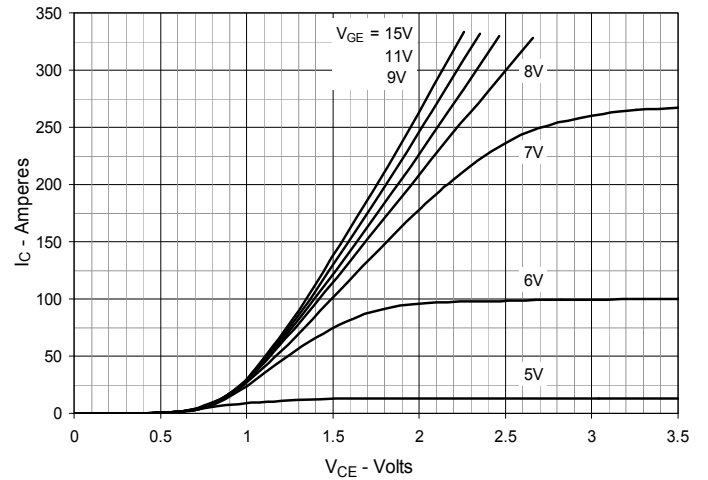

**Fig. 3. Dependence of  $V_{CE(sat)}$  on Junction Temperature**

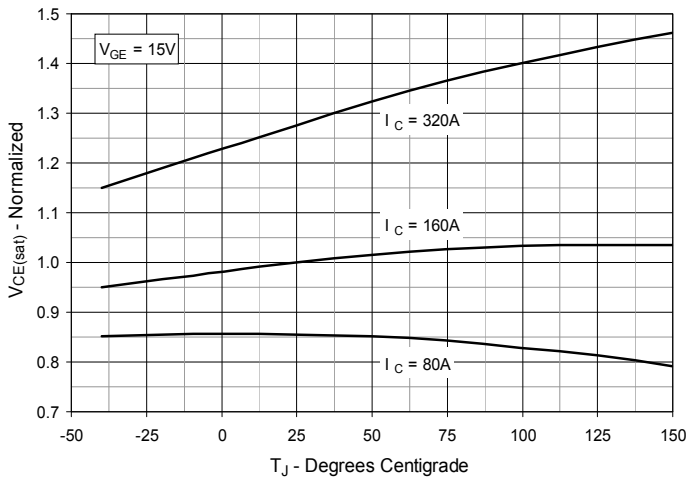

**Fig. 4. Collector-to-Emitter Voltage vs. Gate-to-Emitter Voltage**

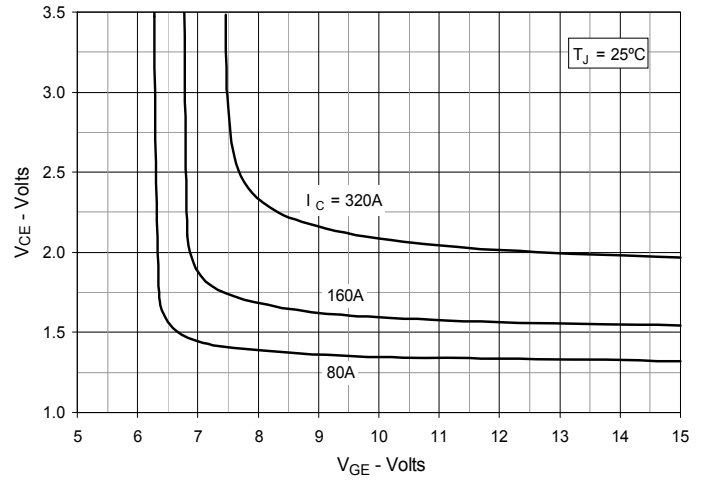

**Fig. 5. Input Admittance**

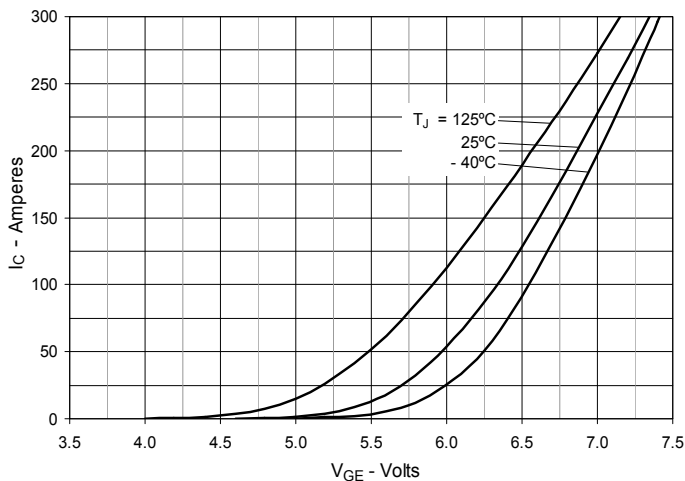

**Fig. 6. Transconductance**

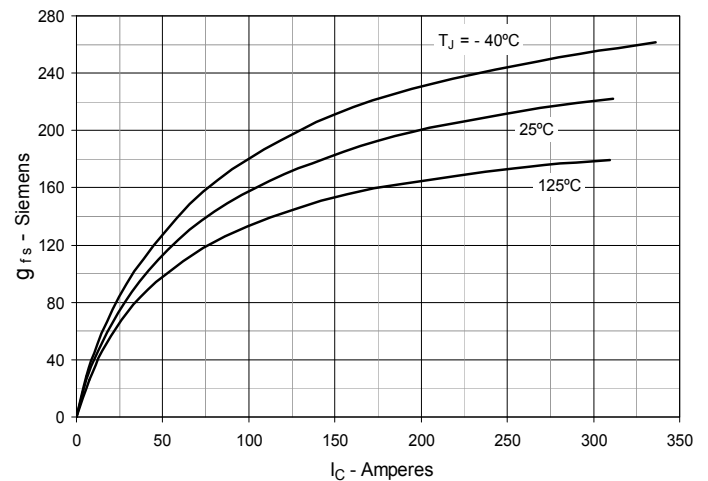

Fig. 7. Gate Charge

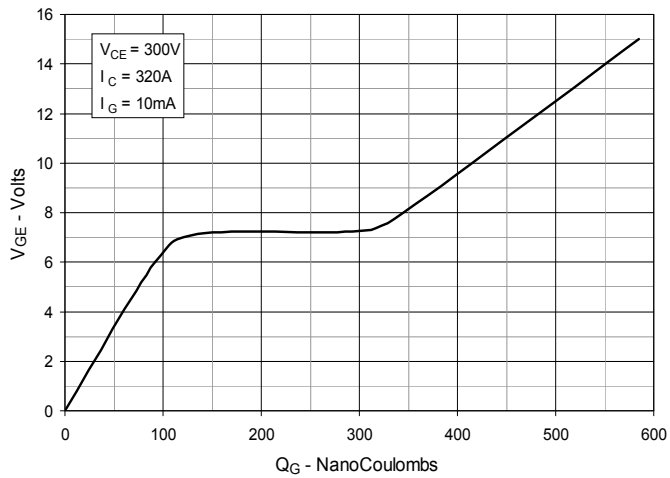

Fig. 8. Capacitance

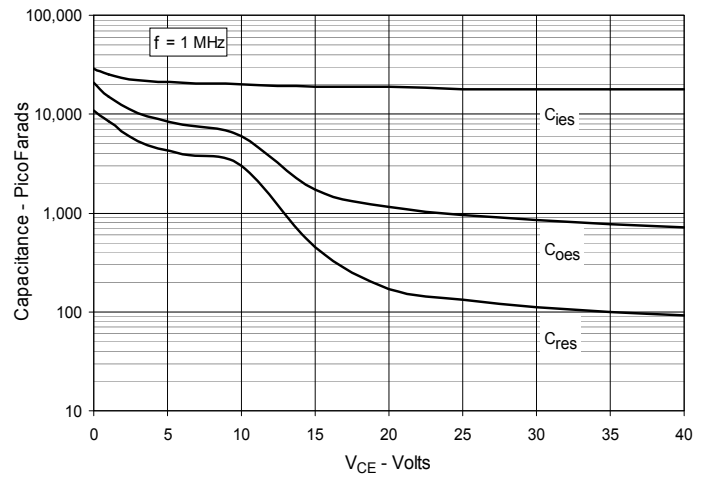

Fig. 9. Reverse-Bias Safe Operating Area

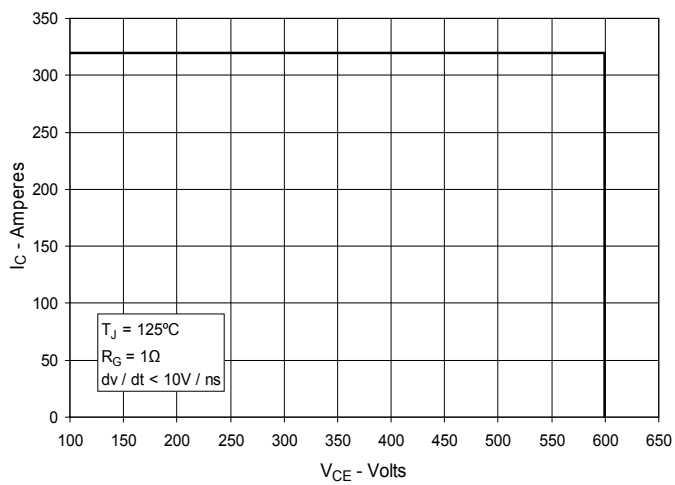
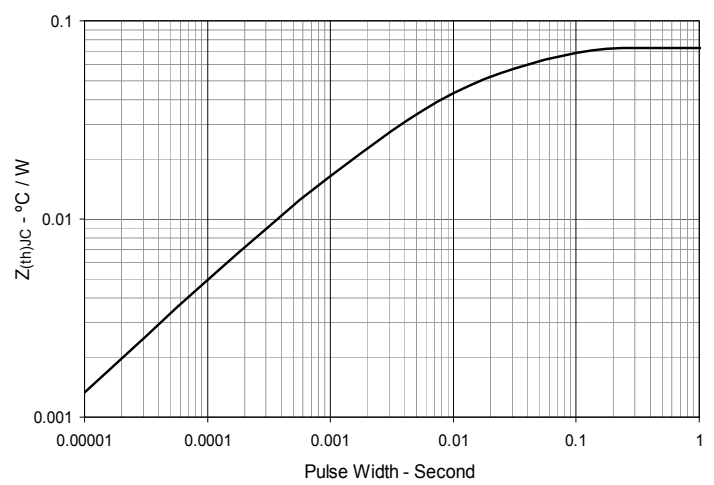
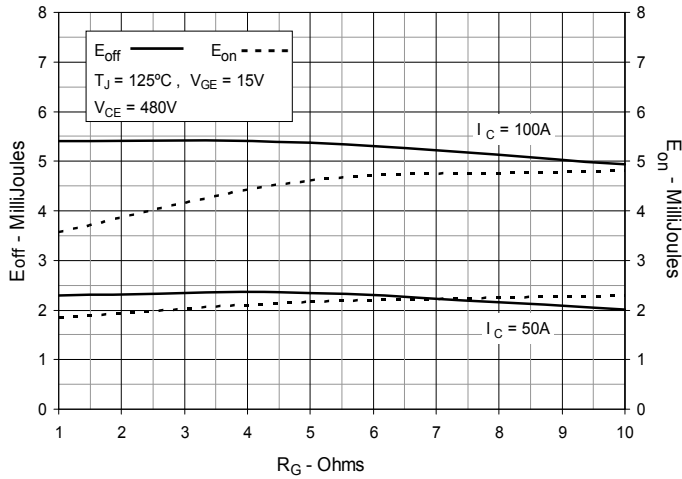

Fig. 10. Maximum Transient Thermal Impedance



**Fig. 11. Inductive Switching Energy Loss vs. Gate Resistance**



**Fig. 12. Inductive Switching Energy Loss vs. Collector Current**

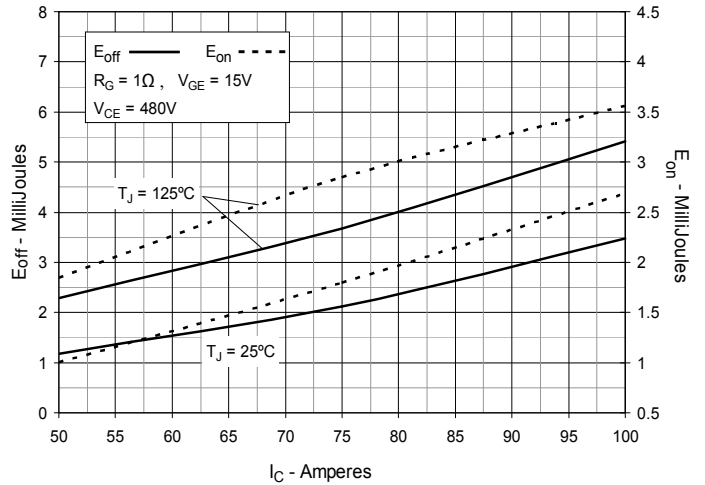

**Fig. 13. Inductive Switching Energy Loss vs. Junction Temperature**

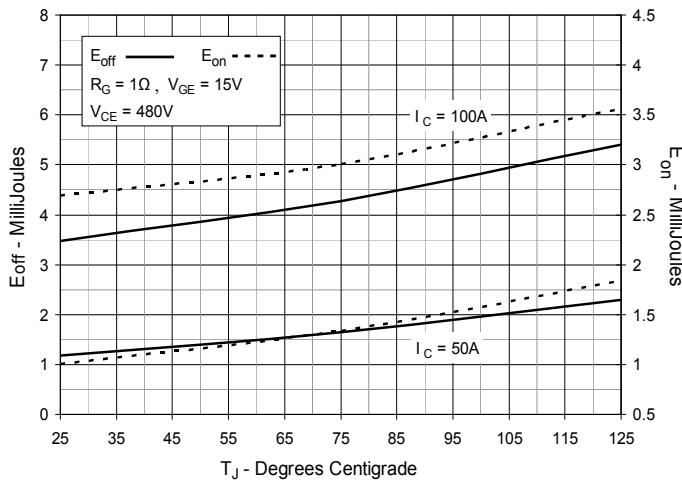

**Fig. 14. Inductive Turn-off Switching Times vs. Gate Resistance**

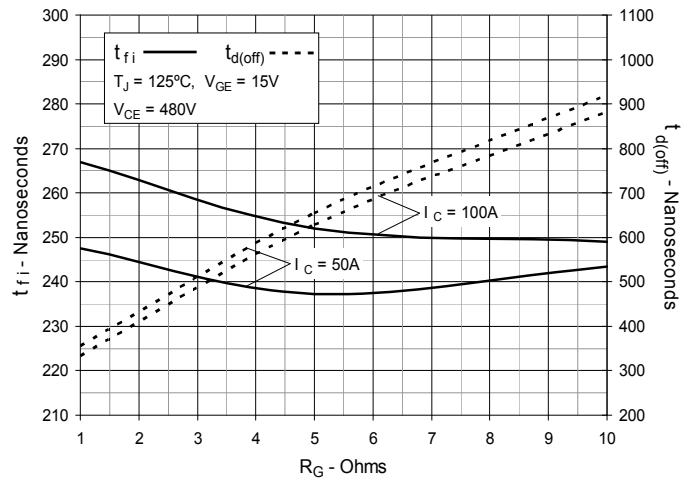

**Fig. 15. Inductive Turn-off Switching Times vs. Collector Current**

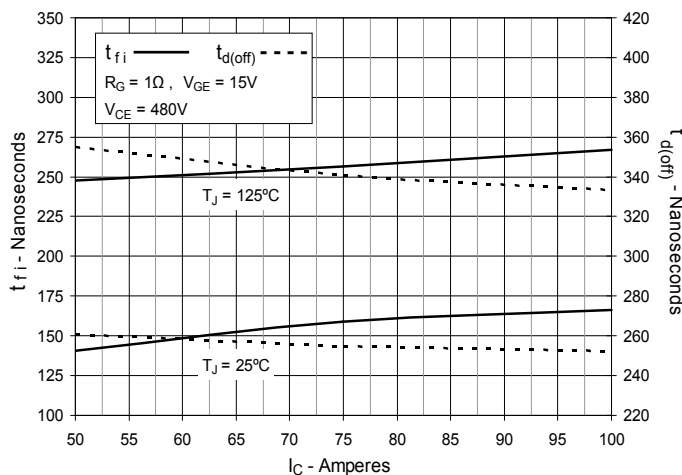

**Fig. 16. Inductive Turn-off Switching Times vs. Junction Temperature**

