

**High Voltage  
XPT™ IGBT**
**IXYA12N250CHV  
IXYH12N250CHV**

$$V_{CES} = 2500V$$

$$I_{C110} = 12A$$

$$V_{CE(sat)} \leq 4.50V$$

$$t_{fi(typ)} = 136ns$$

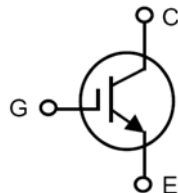

Symbol	Test Conditions	Maximum Ratings	
$V_{CES}$	$T_J = 25^\circ C$ to $175^\circ C$	2500	V
$V_{CGR}$	$T_J = 25^\circ C$ to $175^\circ C$ , $R_{GE} = 1M\Omega$	2500	V
$V_{GES}$	Continuous	$\pm 20$	V
$V_{GEM}$	Transient	$\pm 30$	V
$I_{C25}$	$T_C = 25^\circ C$	28	A
$I_{C110}$	$T_C = 110^\circ C$	12	A
$I_{CM}$	$T_C = 25^\circ C$ , 1ms	80	A
<b>SSOA (RBSOA)</b>	$V_{GE} = 15V$ , $T_{VJ} = 150^\circ C$ , $R_G = 10\Omega$ Clamped Inductive Load	$I_{CM} = 48$ 1500	A V
$P_C$	$T_C = 25^\circ C$	310	W
$T_J$		-55 ... +175	$^\circ C$
$T_{JM}$		175	$^\circ C$
$T_{stg}$		-55 ... +175	$^\circ C$
$T_L$	Maximum Lead Temperature for Soldering	300	$^\circ C$
$T_{SOLD}$	1.6 mm (0.062in.) from Case for 10s	260	$^\circ C$
$M_d$	Mounting Torque (TO-247HV)	1.13/10	Nm/lb.in.
<b>Weight</b>	TO-263HV	2.5	g
	TO-247HV	6.0	g

TO-263HV (IXYA)

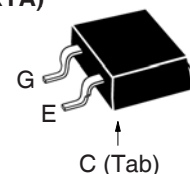

TO-247HV (IXYH)

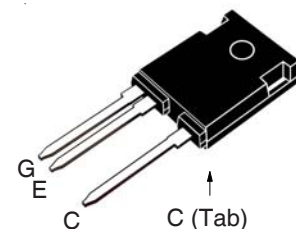

G = Gate      C = Collector  
E = Emitter    Tab = Collector

**Features**

- High Voltage Packages
- High Blocking Voltage
- High Peak Current Capability
- Low Saturation Voltage

**Advantages**

- Low Gate Drive Requirement
- High Power Density

**Applications**

- Switch-Mode and Resonant-Mode Power Supplies
- Uninterruptible Power Supplies (UPS)
- Laser Generators
- Capacitor Discharge Circuits
- AC Switches

Symbol	Test Conditions ( $T_J = 25^\circ C$ , Unless Otherwise Specified)	Characteristic Values		
		Min.	Typ.	Max.
$BV_{CES}$	$I_C = 250\mu A$ , $V_{GE} = 0V$	2500		V
$V_{GE(th)}$	$I_C = 250\mu A$ , $V_{CE} = V_{GE}$	3.0		5.0 V
$I_{CES}$	$V_{CE} = V_{CES}$ , $V_{GE} = 0V$ $T_J = 150^\circ C$			10 $\mu A$ 3 mA
$I_{GES}$	$V_{CE} = 0V$ , $V_{GE} = \pm 20V$			$\pm 100$ nA
$V_{CE(sat)}$	$I_C = 12A$ , $V_{GE} = 15V$ , Note 1 $T_J = 150^\circ C$	3.70	5.55	V V

Symbol Test Conditions		Characteristic Values		
(T <sub>J</sub> = 25°C Unless Otherwise Specified)		Min.	Typ.	Max.
<b>g<sub>fs</sub></b>	I <sub>C</sub> = 12A, V <sub>CE</sub> = 10V, Note 1	7	12	S
<b>R<sub>Gi</sub></b>	Gate Input Resistance		7.5	Ω
<b>C<sub>ies</sub></b>	V <sub>CE</sub> = 25V, V <sub>GE</sub> = 0V, f = 1MHz		1370	pF
<b>C<sub>oes</sub></b>			65	pF
<b>C<sub>res</sub></b>			16	pF
<b>Q<sub>g(on)</sub></b>	I <sub>C</sub> = 12A, V <sub>GE</sub> = 15V, V <sub>CE</sub> = 0.5 • V <sub>CES</sub>		56	nC
<b>Q<sub>ge</sub></b>			6	nC
<b>Q<sub>gc</sub></b>			28	nC
<b>t<sub>d(on)</sub></b>	<b>Inductive load, T<sub>J</sub> = 25°C</b> I <sub>C</sub> = 12A, V <sub>GE</sub> = 15V V <sub>CE</sub> = 0.5 • V <sub>CES</sub> , R <sub>G</sub> = 10Ω Note 2		12	ns
<b>t<sub>ri</sub></b>			16	ns
<b>E<sub>on</sub></b>			3.56	mJ
<b>t<sub>d(off)</sub></b>			167	ns
<b>t<sub>fi</sub></b>			136	ns
<b>E<sub>off</sub></b>			1.70	mJ
<b>t<sub>d(on)</sub></b>	<b>Inductive load, T<sub>J</sub> = 150°C</b> I <sub>C</sub> = 12A, V <sub>GE</sub> = 15V V <sub>CE</sub> = 0.5 • V <sub>CES</sub> , R <sub>G</sub> = 10Ω Note 2		12	ns
<b>t<sub>ri</sub></b>			20	ns
<b>E<sub>on</sub></b>			4.78	mJ
<b>t<sub>d(off)</sub></b>			195	ns
<b>t<sub>fi</sub></b>			138	ns
<b>E<sub>off</sub></b>			1.95	mJ
<b>R<sub>thJC</sub></b>				0.48 °C/W
<b>R<sub>thCS</sub></b>	TO-247HV	0.21		°C/W

**Notes:**

1. Pulse test, t ≤ 300µs, duty cycle, d ≤ 2%.
2. Switching times & energy losses may increase for higher V<sub>CE</sub>(clamp), T<sub>J</sub> or R<sub>G</sub>.

**ADVANCE TECHNICAL INFORMATION**

The product presented herein is under development. The Technical Specifications offered are derived from a subjective evaluation of the design, based upon prior knowledge and experience, and constitute a "considered reflection" of the anticipated result. IXYS reserves the right to change limits, test conditions, and dimensions without notice.

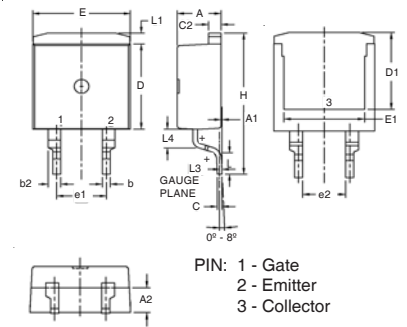
**TO-263HV Outline**

SYM	INCHES		MILLIMETER	
	MIN	MAX	MIN	MAX
A	.170	.185	4.30	4.70
A1	.000	.008	0.00	0.20
A2	.091	.098	2.30	2.50
b	.028	.035	0.70	0.90
b2	.046	.054	1.18	1.38
C	.018	.024	0.45	0.60
C2	.049	.055	1.25	1.40
D	.354	.370	9.00	9.40
D1	.311	.327	7.90	8.30
E	.386	.402	9.80	10.20
E1	.307	.323	7.80	8.20
e1	.200	BSC	5.08	BSC
(e2)	.163	.174	4.13	4.43
H	.591	.614	15.00	15.60
L	.079	.102	2.00	2.60
L1	.039	.055	1.00	1.40
L3	.010	BSC	0.254	BSC
(L4)	.071	.087	1.80	2.20

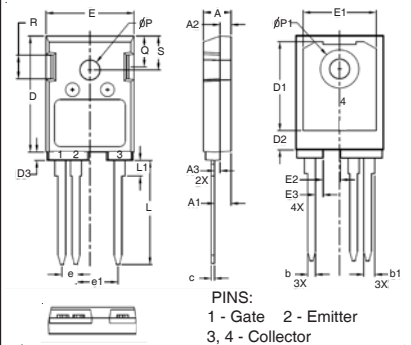
**TO-247HV Outline**

SYM	INCHES		MILLIMETERS	
	MIN	MAX	MIN	MAX
A	.193	.201	4.90	5.10
A1	.114	.122	2.90	3.10
A2	.075	.083	1.90	2.10
A3	.035	.043	0.90	1.10
b	.053	.059	1.35	1.50
b1	.075	.083	1.90	2.10
c	.022	.030	0.55	0.75
D	.819	.843	20.80	21.40
D1	.638	.646	16.20	16.40
D2	.134	.146	3.40	3.70
D3	.055	.063	1.40	1.60
E	.622	.638	15.80	16.20
E1	.520	.528	13.20	13.40
E2	.118	.126	3.00	3.20
E3	.051	.059	1.30	1.50
e	.100	BSC	2.54	BSC
e1	.300	BSC	7.62	BSC
L	.732	.748	18.60	19.00
L1	.106	.118	2.70	3.00
øP	.138	.142	3.50	3.60
øP1	.272	.280	6.90	7.10
Q	.216	.224	5.50	5.70
R	.165	.169	4.20	4.30
S	.240	.248	6.10	6.30

IXYS Reserves the Right to Change Limits, Test Conditions, and Dimensions.

IXYS MOSFETs and IGBTs are covered by one or more of the following U.S. patents:	4,835,592	4,931,844	5,049,961	5,237,481	6,162,665	6,404,065 B1	6,683,344	6,727,585	7,005,734 B2	7,157,338B2
	4,860,072	5,017,508	5,063,307	5,381,025	6,259,123 B1	6,534,343	6,710,405 B2	6,759,692	7,063,975 B2	
	4,881,106	5,034,796	5,187,117	5,486,715	6,306,728 B1	6,583,505	6,710,463	6,771,478 B2	7,071,537	

Fig. 1. Output Characteristics @  $T_J = 25^\circ\text{C}$

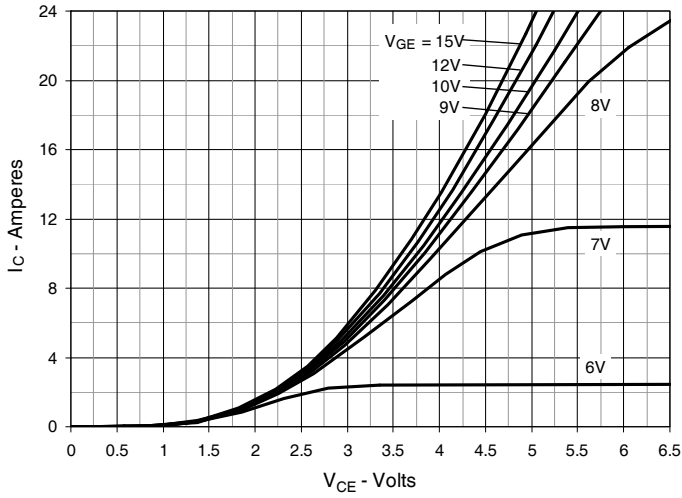

Fig. 2. Extended Output Characteristics @  $T_J = 25^\circ\text{C}$

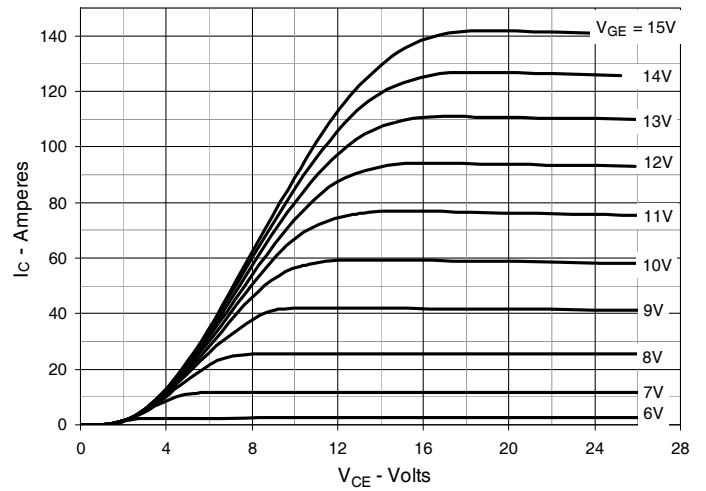

Fig. 3. Output Characteristics @  $T_J = 150^\circ\text{C}$

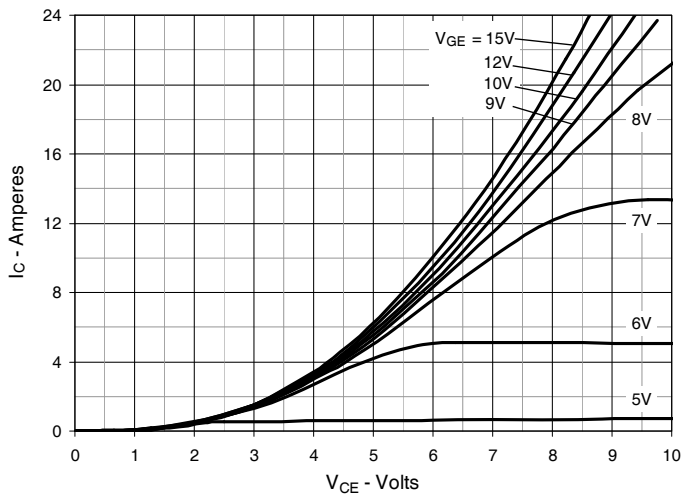

Fig. 4. Dependence of  $V_{CE(sat)}$  on Junction Temperature

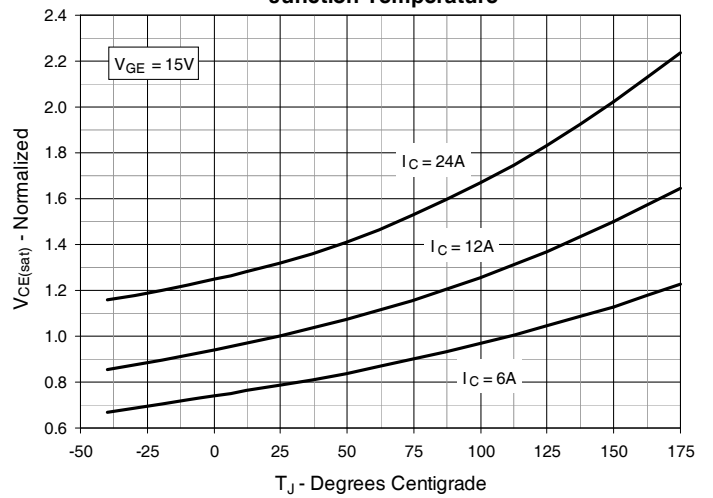

Fig. 5. Collector-to-Emitter Voltage vs. Gate-to-Emitter Voltage

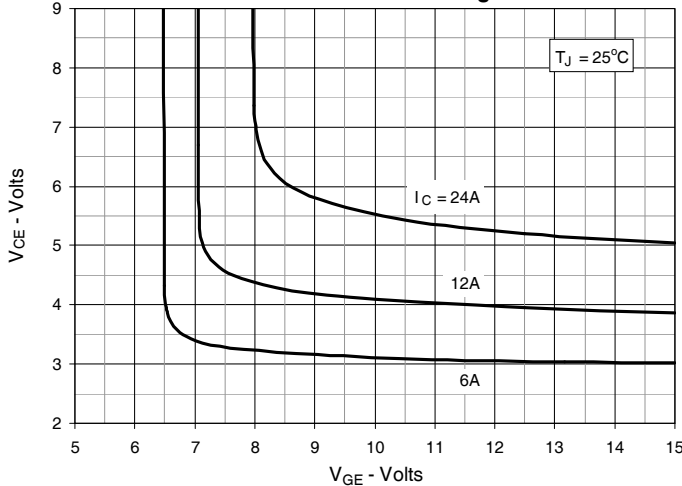

Fig. 6. Input Admittance

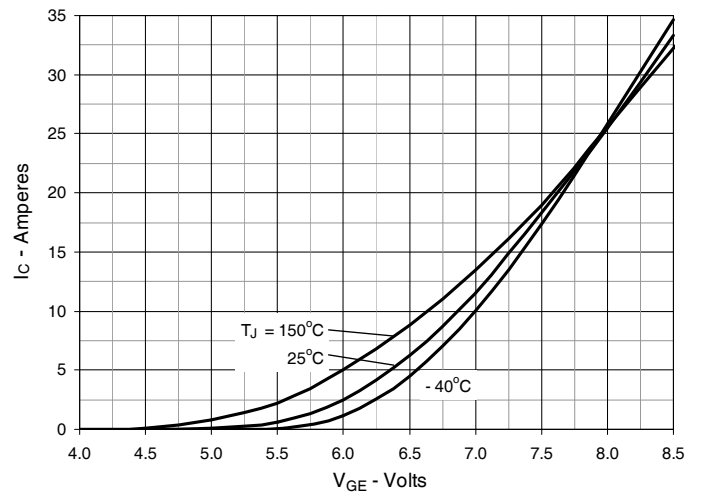

Fig. 7. Transconductance

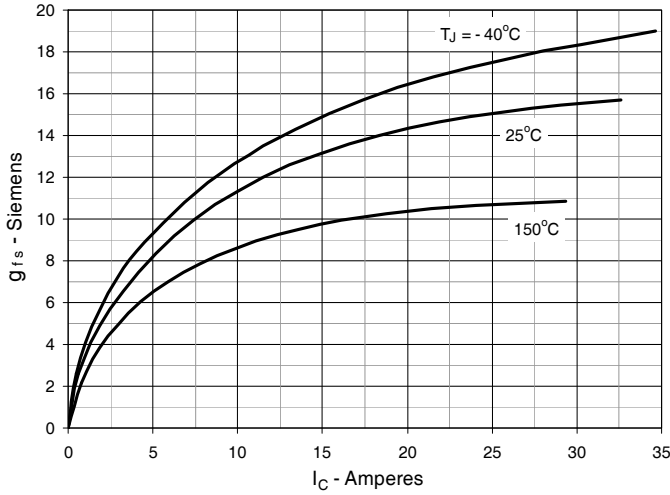

Fig. 8. Gate Charge

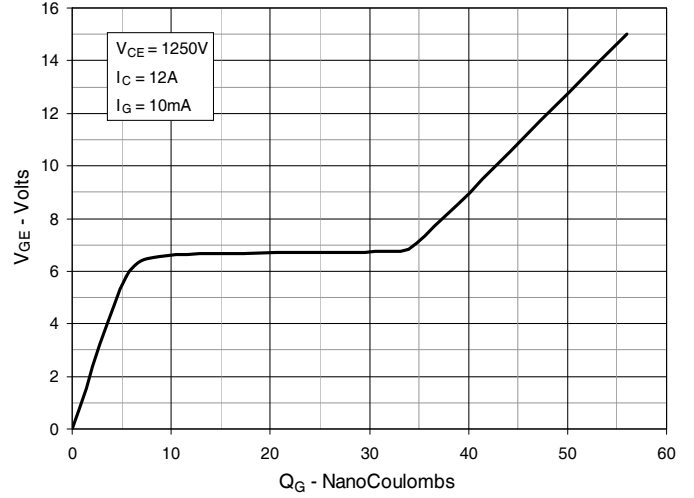

Fig. 9. Capacitance

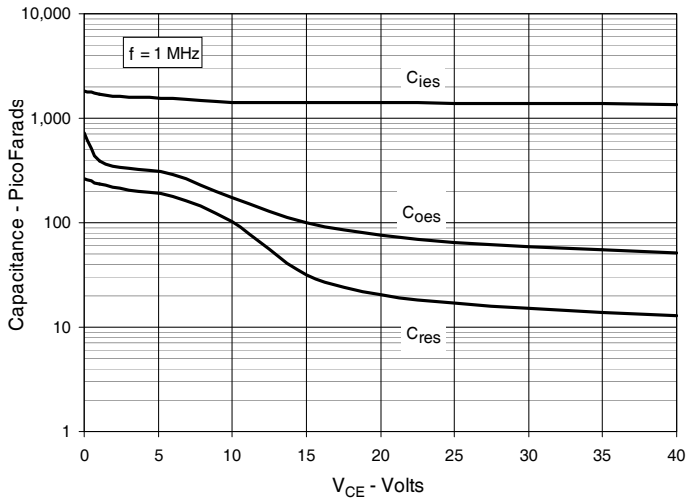

Fig. 10. Reverse-Bias Safe Operating Area

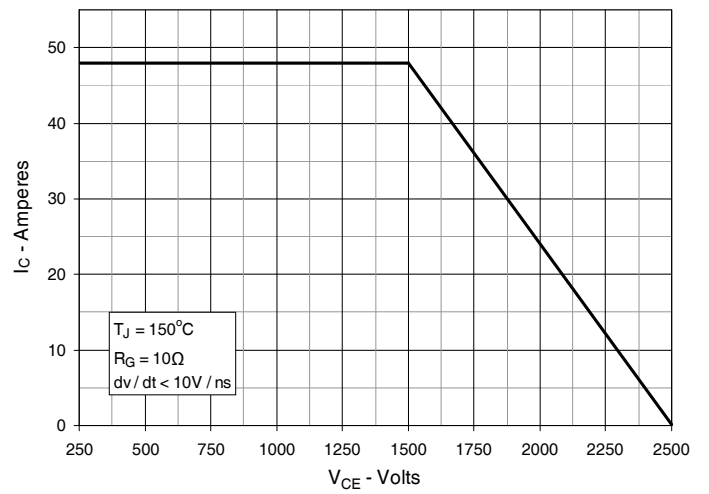
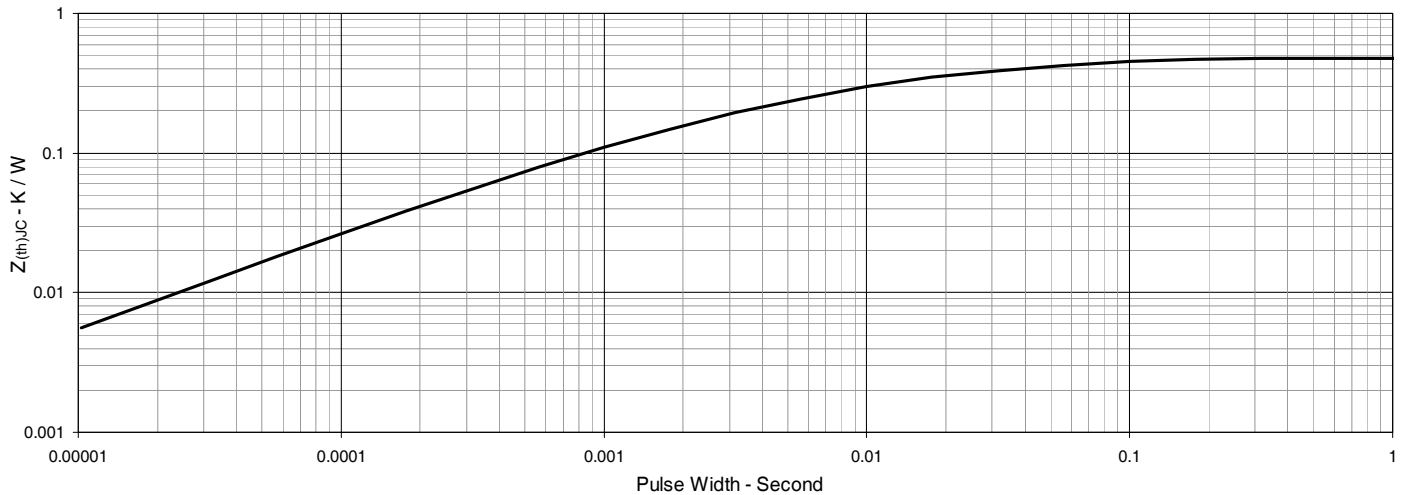
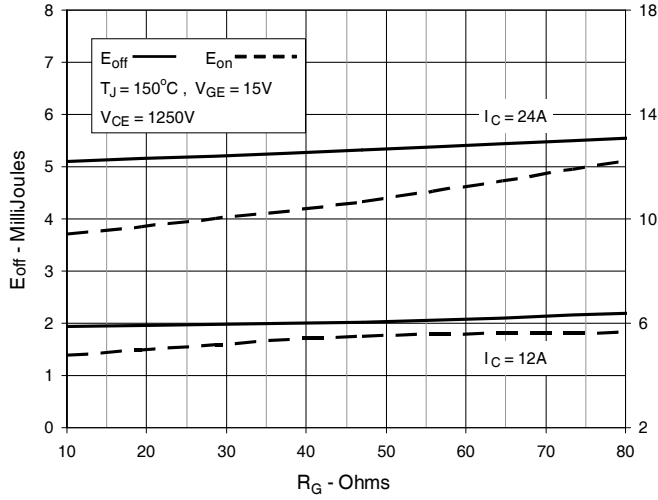

Fig. 11. Maximum Transient Thermal Impedance



**Fig. 12. Inductive Switching Energy Loss vs. Gate Resistance**



**Fig. 13. Inductive Switching Energy Loss vs. Collector Current**

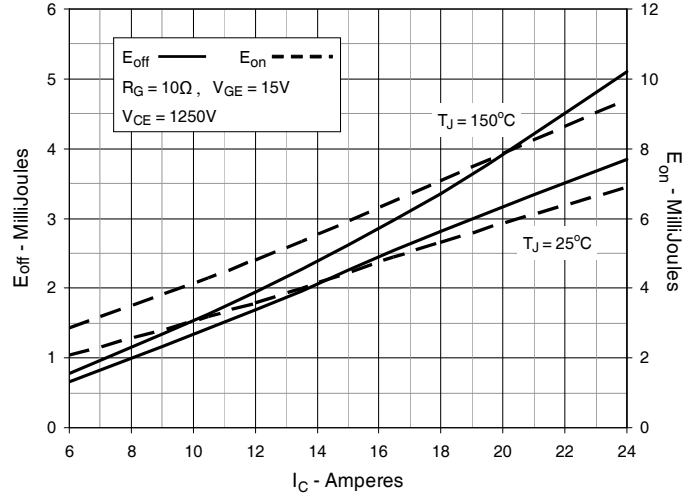

**Fig. 14. Inductive Switching Energy Loss vs. Junction Temperature**

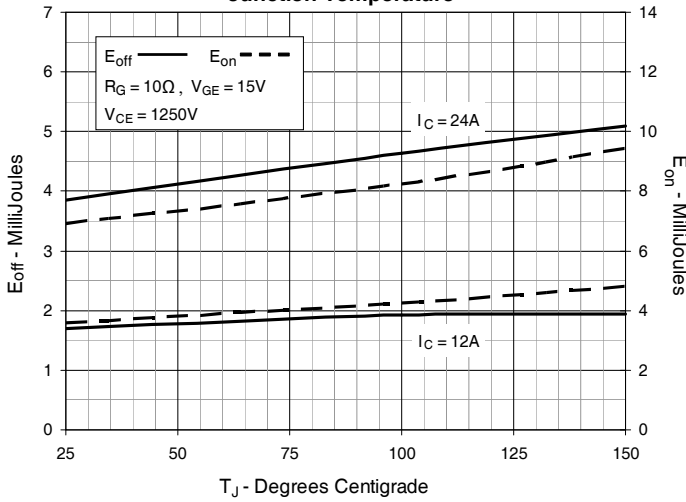

**Fig. 15. Inductive Turn-off Switching Times vs. Gate Resistance**

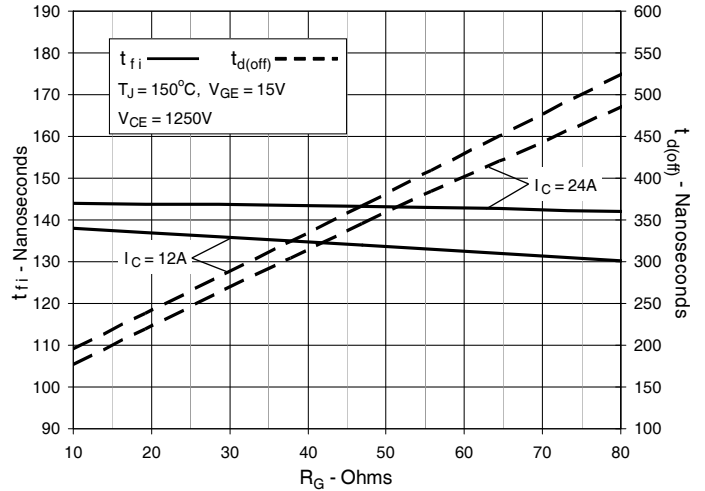

**Fig. 16. Inductive Turn-off Switching Times vs. Collector Current**

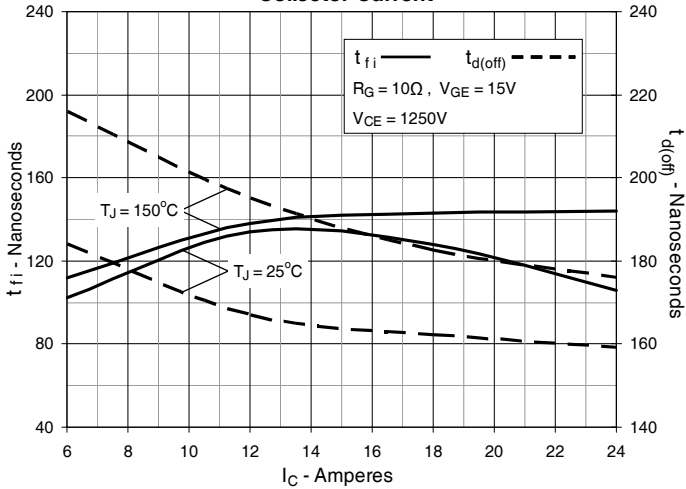

**Fig. 17. Inductive Turn-off Switching Times vs. Junction Temperature**

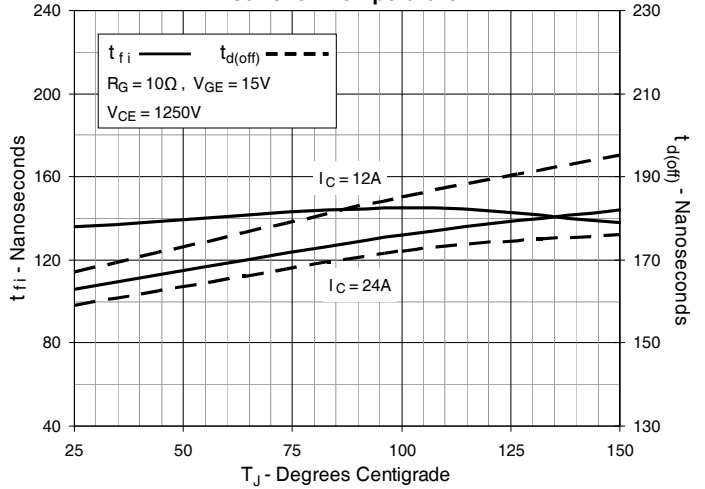

**Fig. 18. Inductive Turn-on Switching Times vs. Gate Resistance**

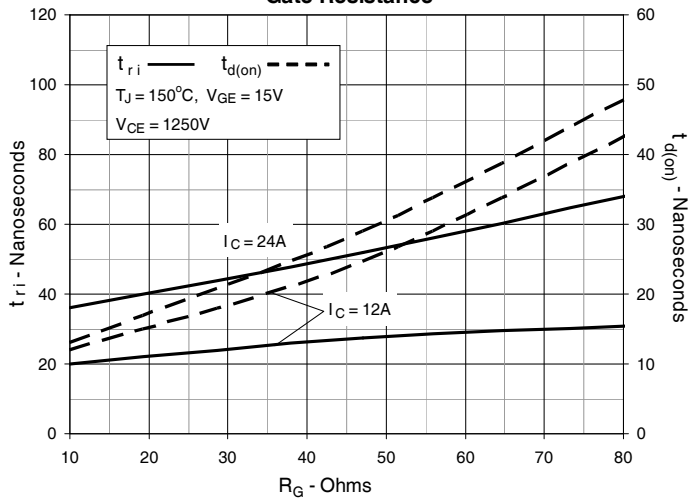

**Fig. 19. Inductive Turn-on Switching Times vs. Collector Current**

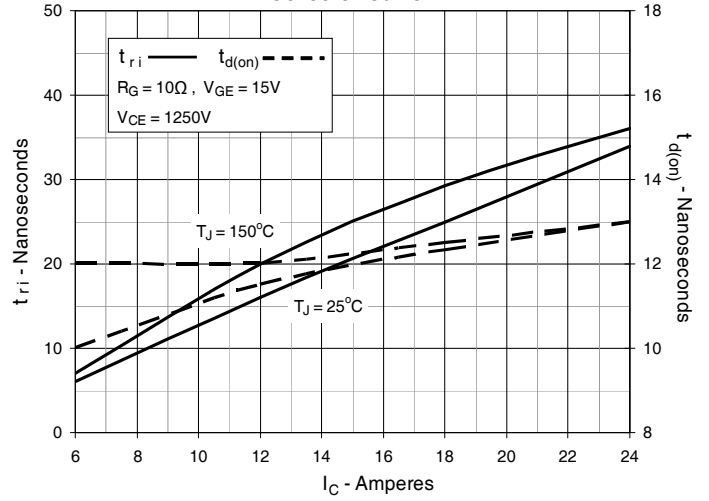

**Fig. 20. Inductive Turn-on Switching Times vs. Junction Temperature**

