

Magnetic Contactor J7KC Series

**Best Match for upto 2.2 kW (240 VAC) *2,
5.5 kW (440 VAC) Motor and
Primary Side switches**

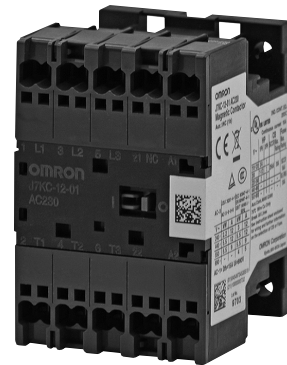

- Push-In Plus wiring Technology saves Wiring and Maintenance time
- World's smallest size (*1)
- Ideal for motor Control up to 2.2 kW (200 to 240 VAC) (*2), 5.5 kW (380 to 440 VAC), AC-3 class
- Ideal for safety applications thanks to mirror contact mechanism with feedback function
- High Contact Reliability (Min. 5 VDC, 3 mA) by Bifurcated contacts
- Coil surge absorber unit installed as standard (*3)
- Certified as compliant with the main safety standards

For the most recent information on models that have been certified for safety standards, refer to your OMRON website.

*1. According to OMRON investigation, as of August 2019. For push-in models.
*2. Based on JIS C 8201-4-1
*3. DC operated

Refer to *Safety Precautions* on page 18.

Model Number Structure

Model Number Legend Order according to the format described in Ordering Information.

J7KC□-12-□□ □□□□
(1) (2) (3) (4)

(1) Non-reversing/reversing

Code	
None	Non-reversing
R	Reversing

(2) Frame size

Code	
12	12 A

(3) Auxiliary contacts

Code	Contact form
10	SPST-1NO
01	SPST-1NC

(4) Coil voltage

Operation	Code	Coil voltage
AC-operated	AC 24	24 VAC
	AC 48	48 VAC
	AC 100	100 VAC
	AC 110	110 VAC
	AC 120	120 VAC
	AC 200	200 VAC
	AC 220	220 VAC
	AC 230	230 VAC
	AC 240	240 VAC
	AC 380	380 VAC
	AC 400	400 VAC
	AC 440	440 VAC
	AC 500	500 VAC

Operation	Code	Coil voltage
DC-operated	DC 12	12 VDC
	DC 24	24 VDC
	DC 48	48 VDC
	DC 60	60 VDC
	DC 100	100 VDC
	DC 110	110 VDC
	DC 120	120 VDC
	DC 200	200 VDC
	DC 210	210 VDC
	DC 220	220 VDC

J7KC Series

Ordering Information

Main unit

Product Type	Operation	Coil rating	Auxiliary contact	Model
Magnetic contactor	AC-operated	24 VAC	SPST-1NO	J7KC-12-10 AC24
			SPST-1NC	J7KC-12-01 AC24
		48 VAC	SPST-1NO	J7KC-12-10 AC48
			SPST-1NC	J7KC-12-01 AC48
		100 VAC	SPST-1NO	J7KC-12-10 AC100
			SPST-1NC	J7KC-12-01 AC100
		110 VAC	SPST-1NO	J7KC-12-10 AC110
			SPST-1NC	J7KC-12-01 AC110
		120 VAC	SPST-1NO	J7KC-12-10 AC120
			SPST-1NC	J7KC-12-01 AC120
		200 VAC	SPST-1NO	J7KC-12-10 AC200
			SPST-1NC	J7KC-12-01 AC200
		220 VAC	SPST-1NO	J7KC-12-10 AC220
			SPST-1NC	J7KC-12-01 AC220
		230 VAC	SPST-1NO	J7KC-12-10 AC230
			SPST-1NC	J7KC-12-01 AC230
		240 VAC	SPST-1NO	J7KC-12-10 AC240
			SPST-1NC	J7KC-12-01 AC240
		380 VAC	SPST-1NO	J7KC-12-10 AC380
			SPST-1NC	J7KC-12-01 AC380
		400 VAC	SPST-1NO	J7KC-12-10 AC400
			SPST-1NC	J7KC-12-01 AC400
		440 VAC	SPST-1NO	J7KC-12-10 AC440
			SPST-1NC	J7KC-12-01 AC440
	500 VAC	SPST-1NO	J7KC-12-10 AC500	
		SPST-1NC	J7KC-12-01 AC500	
	DC-operated (With built-in surge absorption unit)	12 VDC	SPST-1NO	J7KC-12-10 DC12
			SPST-1NC	J7KC-12-01 DC12
		24 VDC	SPST-1NO	J7KC-12-10 DC24
			SPST-1NC	J7KC-12-01 DC24
		48 VDC	SPST-1NO	J7KC-12-10 DC48
			SPST-1NC	J7KC-12-01 DC48
		60 VDC	SPST-1NO	J7KC-12-10 DC60
			SPST-1NC	J7KC-12-01 DC60
		100 VDC	SPST-1NO	J7KC-12-10 DC100
			SPST-1NC	J7KC-12-01 DC100
110 VDC		SPST-1NO	J7KC-12-10 DC110	
		SPST-1NC	J7KC-12-01 DC110	
120 VDC		SPST-1NO	J7KC-12-10 DC120	
		SPST-1NC	J7KC-12-01 DC120	
200 VDC		SPST-1NO	J7KC-12-10 DC200	
		SPST-1NC	J7KC-12-01 DC200	
210 VDC		SPST-1NO	J7KC-12-10 DC210	
		SPST-1NC	J7KC-12-01 DC210	
220 VDC	SPST-1NO	J7KC-12-10 DC220		
	SPST-1NC	J7KC-12-01 DC220		

Product Type	Operation	Coil rating	Auxiliary contact	Model
Reversing magnetic contactor	AC-operated	24 VAC	SPST-1NO	J7KCR-12-10 AC24
			SPST-1NC	J7KCR-12-01 AC24
		48 VAC	SPST-1NO	J7KCR-12-10 AC48
			SPST-1NC	J7KCR-12-01 AC48
		100 VAC	SPST-1NO	J7KCR-12-10 AC100
			SPST-1NC	J7KCR-12-01 AC100
		110 VAC	SPST-1NO	J7KCR-12-10 AC110
			SPST-1NC	J7KCR-12-01 AC110
		120 VAC	SPST-1NO	J7KCR-12-10 AC120
			SPST-1NC	J7KCR-12-01 AC120
		200 VAC	SPST-1NO	J7KCR-12-10 AC200
			SPST-1NC	J7KCR-12-01 AC200
		220 VAC	SPST-1NO	J7KCR-12-10 AC220
			SPST-1NC	J7KCR-12-01 AC220
		230 VAC	SPST-1NO	J7KCR-12-10 AC230
			SPST-1NC	J7KCR-12-01 AC230
		240 VAC	SPST-1NO	J7KCR-12-10 AC240
			SPST-1NC	J7KCR-12-01 AC240
		380 VAC	SPST-1NO	J7KCR-12-10 AC380
			SPST-1NC	J7KCR-12-01 AC380
		400 VAC	SPST-1NO	J7KCR-12-10 AC400
			SPST-1NC	J7KCR-12-01 AC400
		440 VAC	SPST-1NO	J7KCR-12-10 AC440
			SPST-1NC	J7KCR-12-01 AC440
	500 VAC	SPST-1NO	J7KCR-12-10 AC500	
		SPST-1NC	J7KCR-12-01 AC500	
	DC-operated (With built-in surge absorption unit)	12 VDC	SPST-1NO	J7KCR-12-10 DC12
			SPST-1NC	J7KCR-12-01 DC12
		24 VDC	SPST-1NO	J7KCR-12-10 DC24
			SPST-1NC	J7KCR-12-01 DC24
		48 VDC	SPST-1NO	J7KCR-12-10 DC48
			SPST-1NC	J7KCR-12-01 DC48
60 VDC		SPST-1NO	J7KCR-12-10 DC60	
		SPST-1NC	J7KCR-12-01 DC60	
100 VDC		SPST-1NO	J7KCR-12-10 DC100	
		SPST-1NC	J7KCR-12-01 DC100	
110 VDC		SPST-1NO	J7KCR-12-10 DC110	
		SPST-1NC	J7KCR-12-01 DC110	
120 VDC		SPST-1NO	J7KCR-12-10 DC120	
		SPST-1NC	J7KCR-12-01 DC120	
200 VDC		SPST-1NO	J7KCR-12-10 DC200	
		SPST-1NC	J7KCR-12-01 DC200	
210 VDC		SPST-1NO	J7KCR-12-10 DC210	
		SPST-1NC	J7KCR-12-01 DC210	
220 VDC	SPST-1NO	J7KCR-12-10 DC220		
	SPST-1NC	J7KCR-12-01 DC220		

J7KC Series

Options (Order Separately)

Auxiliary contact unit

Number of poles	Auxiliary contact	Model
2 poles	2PST-2NO	J73KC-AM-20
	2PST-1NO 1NC	J73KC-AM-11
	2PST-2NC	J73KC-AM-02
4 poles	4PST-4NO	J73KC-AM-40
	4PST-3NO 1NC	J73KC-AM-31
	4PST-2NO 2NC	J73KC-AM-22
	4PST-1NO 3NC	J73KC-AM-13
	4PST-4NC	J73KC-AM-04

Interlock unit

Model
J74KC-A

Reversing conductor kit

Type	Model
For main circuit	J75KC-WKR-A
For auxiliary circuit	J75KC-WKR-B

Coil surge absorption unit

Adopted Coil voltage type	LED indicator	Model
24-48 VAC	No	J76KC-RC-1
48-125 VAC		J76KC-RC-2
100-250 VAC		J76KC-RC-3
24-48 VAC	Yes	J76KC-RC-N-1
48-125 VAC		J76KC-RC-N-2

Insulation stop

Model	Minimum order (bag)
J77KC-K	1 (30 pcs./bag)

Tools for removal

Model
J78KC

Ratings/Specifications

The ratings/specifications are the same for both non-reversing/reversing types.

Coil rating

AC operated

Displayed model	Rated voltage		Allowable voltage range		Must operate voltage	Must release voltage
	50 Hz	60 Hz	50 Hz	60 Hz		
AC 24	24 VAC	24-26 VAC	85 to 110%	21-27 VAC	21-29 VAC	85% max. 20% min.
AC 48	48 VAC	48-52 VAC		41-53 VAC	41-58 VAC	
AC 100	100 VAC	100-110 VAC		85-110 VAC	85-121 VAC	
AC 110	100-110 VAC	110-120 VAC		85-121 VAC	94-132 VAC	
AC 120	110-120 VAC	120-130 VAC		94-132 VAC	102-143 VAC	
AC 200	200 VAC	200-220 VAC		170-220 VAC	170-242 VAC	
AC 220	200-220 VAC	220-240 VAC		170-242 VAC	187-264 VAC	
AC 230	220-230 VAC	230 VAC		187-253 VAC	196-253 VAC	
AC 240	220-240 VAC	240-260 VAC		187-264 VAC	204-286 VAC	
AC 380	346-380 VAC	380-420 VAC		295-418 VAC	323-462 VAC	
AC 400	380-400 VAC	400-440 VAC		323-440 VAC	340-484 VAC	
AC 440	415-440 VAC	440-480 VAC		353-484 VAC	374-528 VAC	
AC 500	480-500 VAC	500-550 VAC		408-550 VAC	425-605 VAC	

DC operated

Displayed model	Rated voltage	Allowable voltage range	Must operate voltage	Must release voltage	
DC 12	12 VDC	85 to 110%	85% max.	10% min.	
DC 24	24 VDC				11-14 VDC
DC 48	48 VDC				21-27 VDC
DC 60	60 VDC				41-53 VDC
DC 100	100 VDC				51-66 VDC
DC 110	110 VDC				85-110 VDC
DC 120	120 VDC				94-121 VDC
DC 200	200 VDC				102-132 VDC
DC 210	210 VDC				170-220 VDC
DC 220	220 VDC				179-231 VDC
					187-242 VDC

Coil characteristics (reference value)

AC operated

Frequency	50 Hz	60 Hz	
Coil power consumption	Making (VA)	22 (200 V)	25 (220 V)
	Holding (VA)	4.5 (200 V)	4.5 (220 V)
Power loss (W)	1.2 (200 V)	1.3 (220 V)	
Must operate voltage (V)	122 to 135	128 to 138	
Must release voltage (V)	80 to 89	83 to 96	
Operate time (ms)	17 to 26		
Release time (ms)	6 to 16		

- Note:**
1. Coil ratings: Characteristics for 200 VAC, 50 Hz / 200-220 VAC, 60 Hz
 2. Coil power consumption value is the same for a coil that is not rated 200 VAC.
 3. Indicated operate/release times for 200 VAC, 50 Hz.
 4. Closed and open voltages of 100 V coil (100 VAC, 50 Hz/100-110 VAC, 60 Hz) are approximately one half the values in the table above.
 5. Values in the table above are examples for 20°C cold condition.

DC operated

Coil power consumption	Making (W)	2.4 (24 V)
	Holding (W)	2.2 (24 V)
Time constant (ms)	Holding	20
Must operate voltage (V)	10 to 11	
Must release voltage (V)	4 to 6	
Operate time (ms)	34 to 60	
Release time (ms)	5 to 10	

- Note:**
1. Coil ratings: Characteristics for 24 VDC
 2. Coil power consumption value is the same for a coil that is not rated 24 VDC.
 3. Values in the table above are examples for 20°C cold condition.

Ratings/Characteristics

Main circuit rating	Rating based on IEC 60947-4-1	AC-1 (Resistive load)	Voltage range (V)		AC200-240 AC		AC380-440 AC			
			Rated operational current (A)		15		15			
		AC-3 (3-phase cage motor)	Voltage range (V)		200-240 AC	380-440 AC	500-550 AC	600-690 AC		
			Rated capacity (kW)		3	5.5	5.5	4		
			Rated operational current (A)		12	12	9	5		
		AC-4 (3-phase cage motor)	Voltage range (V)		200-240 AC	380-440 AC	500-550 AC	600-690 AC		
			Rated capacity (kW)		3	5.5	5.5	4		
			Rated operational current (A)		12	12	9	5		
		DC-1 (Resistive load L/R ≤ 1 ms)	Voltage range (V)		24 DC	48 DC	110 DC	220 DC		
			Rated operational current (A)	Number of serial contacts 1		12	12	3	0.7	
				Number of serial contacts 2		12	12	9	4	
				Number of serial contacts 3		12	12	12	12	
	DC-3, DC-5 (DC motor load L/R ≤ 15 ms)	Voltage range (V)		24 DC	48 DC	110 DC	220 DC			
		Rated operational current (A)	Number of serial contacts 1		2	1.5	1	0.1		
			Number of serial contacts 2		10	3	0.85	0.35		
			Number of serial contacts 3		12	6	1.7	0.7		
	Conventional free air thermal current (rated flowing current) (A)			15						
	Rating based on UL 60947-4-1, CSA C22.2	3-phase motor	Voltage range (V)		200 AC	220-240 AC	440-480 AC	550-600 AC		
			Rated capacity (HP)		3	3	5	5		
			Rated operational current (A)		11	9.6	7.6	6.1		
			Rated current (A)		15					
		Single-phase motor	Voltage range (V)		110-120 AC	200 AC	220-240 AC			
			Rated capacity (HP)		3/4	1-1/2	2			
			Rated operational current (A)		13.8	11.5	12			
Rated current (A)			15							
FUSE			30A (Class K5, RK5)							
Rating based on JIS C 8201-4-1		AC-1 (resistive load)	Voltage range (V)		200-240 AC		380-440 AC			
	Rated operational current (A)		15		15					
	AC-3 (3-phase cage motor)	Voltage range (V)		200-240 AC	380-440 AC	500-550 AC				
		Rated capacity (kW)		2.2	5.5	5.5				
		Rated operational current (A)		12	12	9				
	DC-1 (Resistive load L/R ≤ 1 ms)	Voltage range (V)		24 DC	48 DC	110 DC	220 DC			
		Rated operational current (A)	Number of serial contacts 1		12	12	3	0.7		
			Number of serial contacts 2		12	12	9	4		
			Number of serial contacts 3		12	12	12	12		
	DC-3, DC-5 (DC motor load L/R ≤ 15 ms)	Voltage range (V)		24 DC	48 DC	110 DC	220 DC			
		Rated operational current (A)	Number of serial contacts 1		2	1.5	1	0.1		
			Number of serial contacts 2		10	3	0.85	0.35		
Number of serial contacts 3			12	6	1.7	0.7				
Conventional free air thermal current (rated flowing current) (A)			15							
Minimum operate voltage/current (reference value)			24 VDC 10 mA							
Electrical/ mechanical endurance	Voltage range (V)		220 AC		440 AC					
	Rated operational current (A)		12		12					
	Contact closed current (A)		144		144					
	Breaking current (A)		120		120					
	Switching frequency (times per hour)		1800		1800					
	Endurance (10,000 operations min.)	Mechanical		1000		1000				
Electrical (AC3)		100 *								
Contact resistance (reference value)			10 mΩ max. (6 VDC, 1 mA, voltage drop method)							

* The electrical endurance is the value at 200 V based on the electrical endurance test conditions assumed in the IEC/JIS standards, and will vary depending on the characteristics and load conditions of the motor you use. A large motor starting current may cause a decrease of electrical endurance or contact sticking.

Auxiliary circuit rating	Rating based on IEC 60947-5-1/ JIS C 8201-5-1	Voltage range (V)		100-120 AC	200-240 AC	380-440 AC	500-600 AC	24 DC	48 DC	110 DC	220 DC	
		Rated operational current (A)	AC-15 (coil load)				DC-13 (coil load)					
			3	3	1	0.5	2	1	0.3	0.2		
			AC-12 (resistive load)				DC-12 (resistive load)					
		Contact closed and breaking current (A)	30	30	10	5	30	30	10	5		
	Conventional free air thermal current (rated flowing current) (A)	10										
	Rating based on UL 508	Rated carry current (A)		10						2.5		
		Voltage range (V)		120 AC	240 AC	480 AC	600 AC	125 DC	250 DC			
		Contact closed current (A)		60	30	15	12	0.55	0.27			
		Breaking current (A)		6	3	1.5	1.2	0.55	0.27			
	Rating code		A 600						Q 300			
	Minimum operate voltage/current (reference value)			3 mA at 5 VDC								
	Electrical/mechanical endurance	Switching frequency (times per hour)		1800								
		Mechanical (10,000 cycles min.)		1000								
		Electrical (10,000 cycles min.)	AC-15	220 V	50							
440 V				50								
AC-12			220 V	25								
			440 V	25								
DC-13	220 V		15									
DC-12	220 V	50										
Contact resistance (reference value)			50 mΩ max. (6 VDC, 1 mA, voltage drop method)									
Rated insulation voltage			690 VAC									
Rated impulse dielectric strength			6 kV									
Rated frequency			50/60 Hz									
Vibration resistance			Vibration: 10 to 55 Hz, acceleration: 15 m/s ²									
Shock resistance			Shock value 50 m/s ²									
Contact form			Double break form (main circuit: single contacts, auxiliary circuit: bifurcated contacts)									
Contact material			Ag alloy									
Mirror contact			Available *									
Degree of protection			IP20 (IEC60529)									
Operating temperature			-10 to +55°C (however, daily average shall not exceed 35°C)									
Ambient storage temperature			-40 to +65°C (no condensation or icing)									
Relative humidity			45% to 85% RH (no condensation or icing)									
Altitude			2000 m max.									
Weight			160 g (J7KC-□-AC)/190 g (J7KC-□-DC)/400 g (J7KCR-□-AC)/460 g (J7KCR-□-DC)									
Applicable Standards		Safety standard		EN 60947-4-1(IEC 60947-4-1), UL 60947-4-1, CSA 22.2 No.60947-4-1, CCC GB/T14048.4								

* A mirror contact is a mechanism found mainly in contactors.

With the combination of the main circuit and the auxiliary circuit of the main unit, welding the main contacts will result in a structure that secures a shock resistance voltage of 2.5 kV or more, or a contact interval of 0.5 mm or more, for all of the auxiliary circuit NC contacts even if the excitation of the coil is released. The main contact may turn on even if the auxiliary circuit is welded. Even with the combined usage of the auxiliary contact unit (J73KC-AM), welding the main contact in the main unit will create a mirror contact surface where the attached auxiliary contact (NC contact) is separated.

J7KC Series

Engineering Data

Electrical endurance curves

AC-3 breaking current and electrical endurance curve (Based on IEC 60947-4-1)

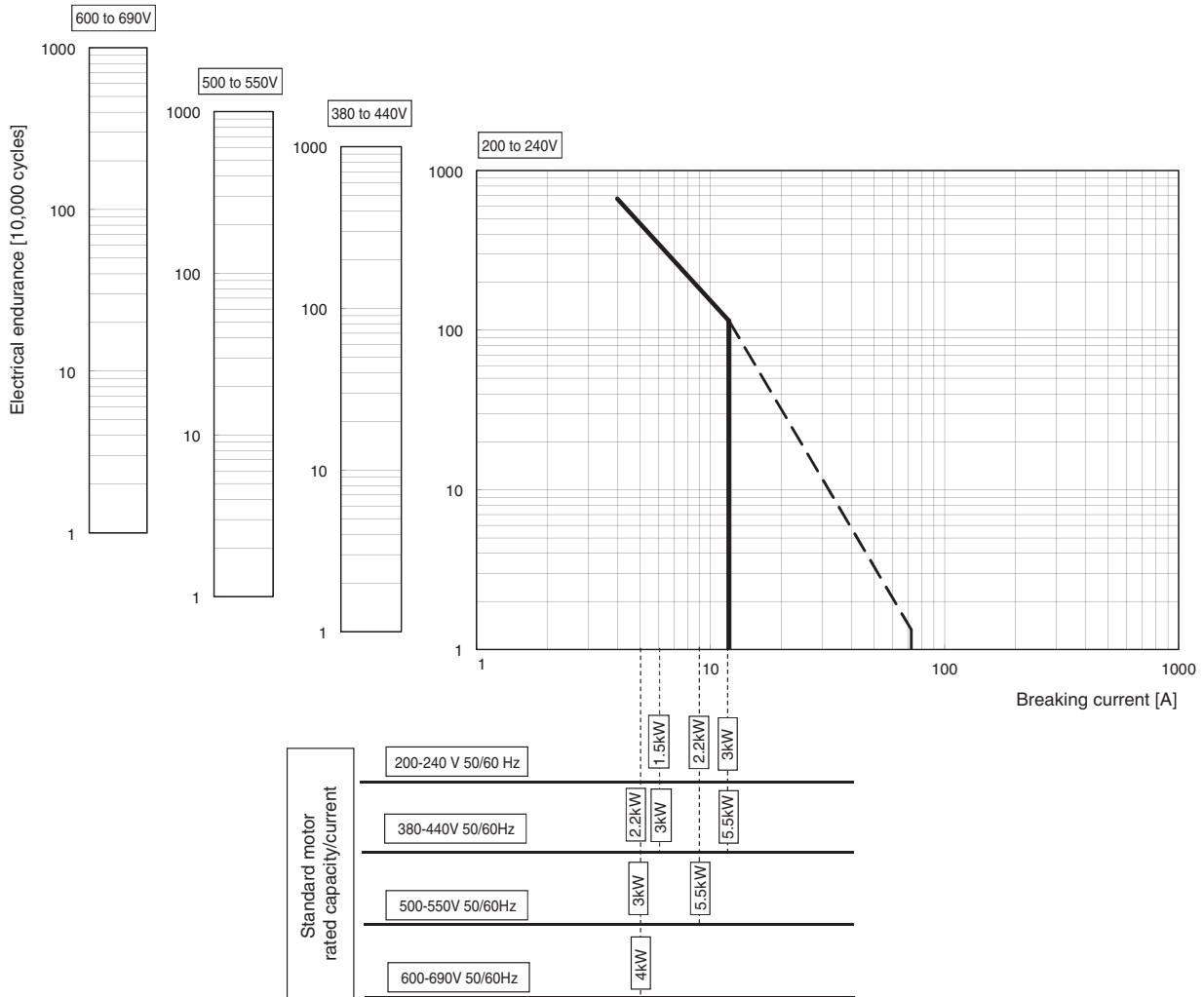

AC-1 breaking current and electrical endurance curve (for resistive load) (Based on IEC 60947-4-1)

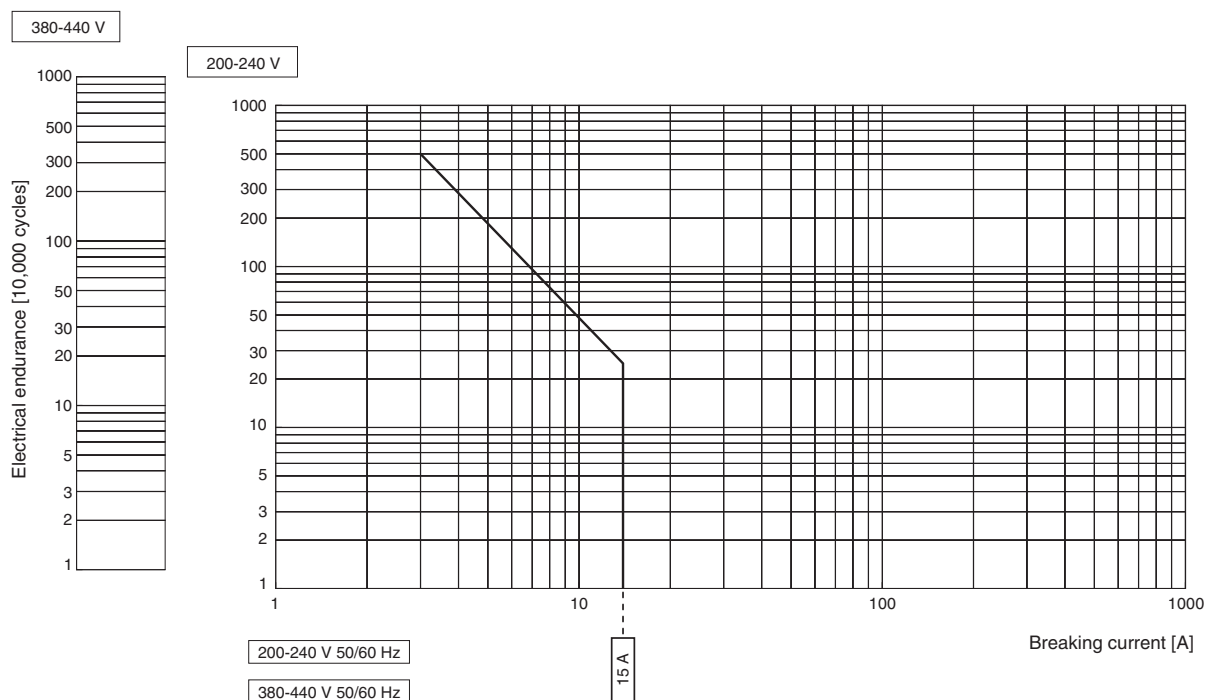

Dimensions

Main unit Magnetic contactor J7KC

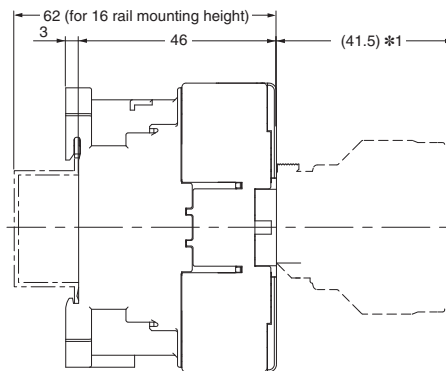
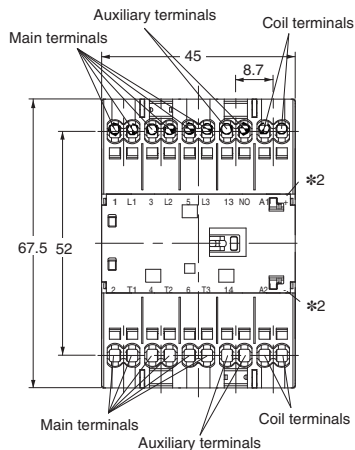

*1. When auxiliary contact unit (J73KC) is mounted

Auxiliary contact	Contact form
1NO (1a)	
1NC (1b)	

*2. For DC-operated model

Reversing magnetic contactor J7KCR

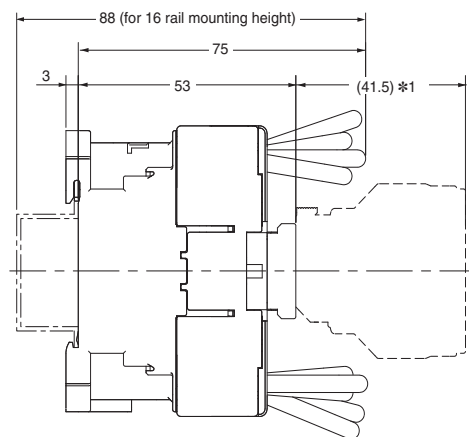
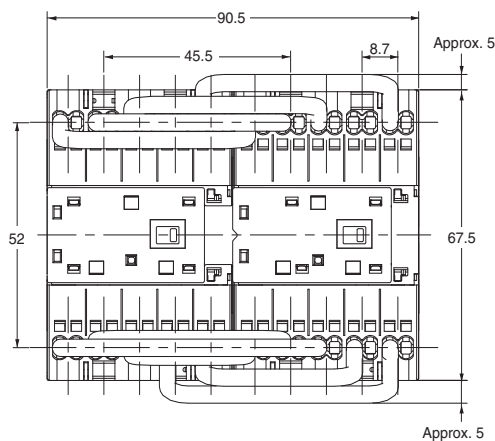

*1. When auxiliary contact unit (J73KC) is mounted

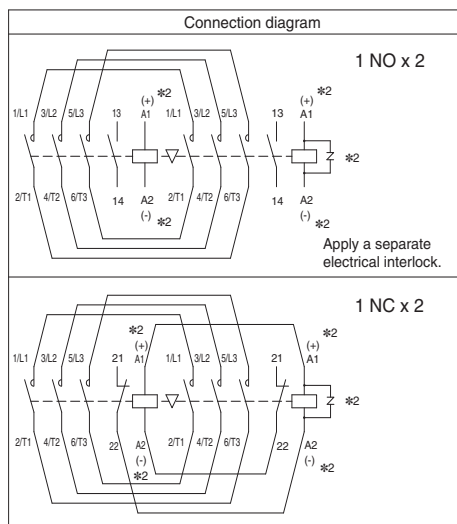

Note: The terminal (number) names of the reversing magnetic contactor are the same as the magnetic contactor.

*2. For DC-operated model

J7KC Series

Related Products (Order Separately)

Thermal overload relay

J7TC

Combine with a thermal overload relay to use as a magnetic switch.

For details, refer to *J7TC Thermal Overload Relay Data Sheet* (Catalog No. J231-E1).

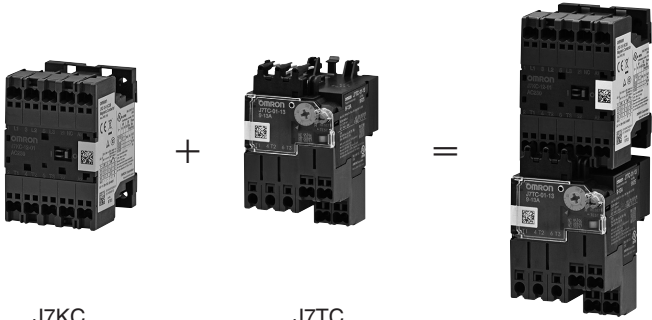

J7KC

J7TC

Magnetic starters



Magnetic starters

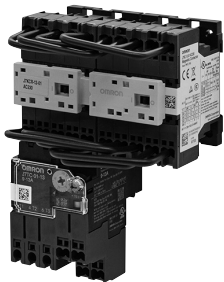
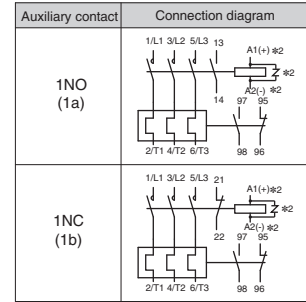
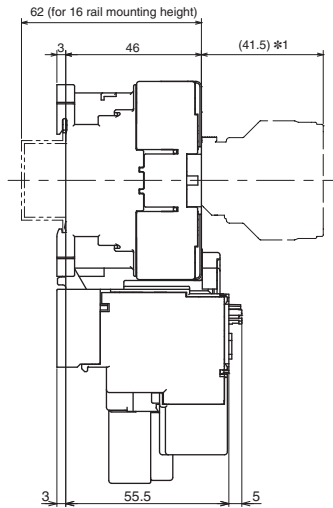
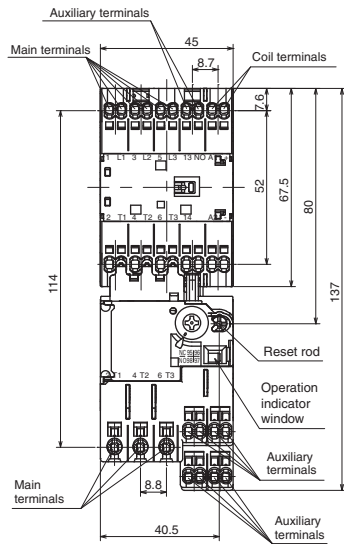

Reversing type magnetic starters

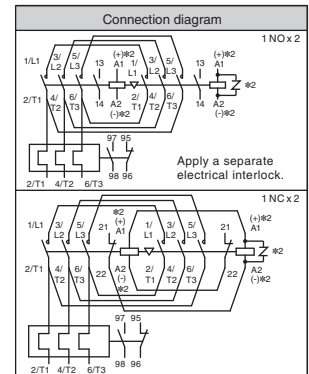
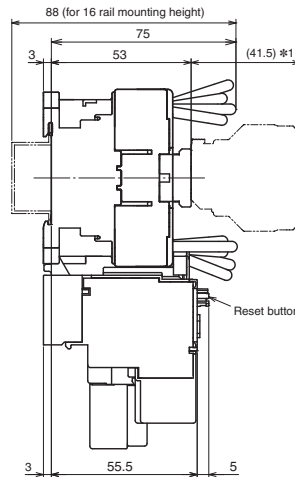
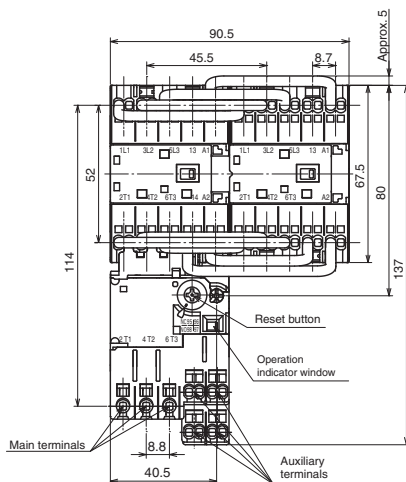

*1 When auxiliary contact unit (J73KC) is mounted
*2 For DC-operated model

**Coordination with the short circuit protection device (SCPD)
(based on IEC and JIS standards)**

Assumed short circuit current "r" (240 V, 440 V)

Magnetic starters			Coordination type				
Magnetic contactor	Thermal overload relay		Type 1			Type 2	
	Setting current range [A]	Short-circuit current "r" [kA]	Breaker EN60947-2	Rating [A]	Short-circuit current "r" [kA]	Fuse rating [A] (IEC 60269-1 gG and gM)	
J7KC-12	J7TC-01	0.34-0.52	1	Breaker for wiring protection (MCCB) Icu 240 V 5 kA 440 V 2.5 kA	3	1	2
		0.48-0.72			5		4
		0.64-0.96			10		16
		0.8-1.2			20		
		0.95-1.45					
		1.1-1.65					
		1.4-2.1					
		1.7-2.6					
		2.2-3.4					
		2.8-4.2					
		4-6					
		5-7.5					
		6-9					
7-10.5							
9-13	30						

Conditional rated short circuit current Iq (240 V)

Magnetic starters			Coordination type				
Magnetic contactor	Thermal overload relay		Type 1			Type 2	
	Setting current range [A]	Short-circuit current "Iq" [kA]	Breaker EN60947-2	Rating [A]	Short-circuit current "Iq" [kA]	Fuse rating [A] (IEC 60269-1 gG and gM)	
J7KC-12	J7TC-01	0.34-0.52	25	Breaker for wiring protection (MCCB) Icu 240 V 5 kA 440 V 2.5 kA	3	50	2
		0.48-0.72			5		4
		0.64-0.96			10		16
		0.8-1.2					
		0.95-1.45					
		1.1-1.65					
		1.4-2.1					
		1.7-2.6					
		2.2-3.4					
		2.8-4.2					
		4-6					
		5-7.5					
		6-9					
7-10.5							
9-13	30	20					
	Breaker for wiring protection (MCCB) Icu 240 V 50 kA 440 V 30 kA						

J7KC Series

Manual motor starter

J7MC

For details, refer to *J7MC Manual Motor Starter Data Sheet* (Catalog No. J233-E1).



Short-circuit harmonized protection

Satisfies the harmonized protection types 1 and 2 for magnetic switches and short-circuit protection devices specified in IEC 60947 and JIS C 8201.

- Type 1: Damage to magnetic contactors and thermal overload relays is observed. Requires partial or complete replacement at the time of inspection.
- Type 2: No damage, except slight welding of the contacts in the magnetic contactor. Can remain in use without replacement at the time of inspection.

This greatly reduces the possibility of secondary accidents in the event that an accident occurs.

Type 1 rated conditional short-circuit current $I_q = 50$ kA (200 VAC, 400 VAC)

3-phase motor capacity and full load current				Manual motor starter			Short-circuit current I_q [kA]	Magnetic contactor	
200 VAC		400 VAC		Model		Current setting range [A]		Model	Rated operational current AC-3 [A]
Capacity [kW]	Current [A]	Capacity [kW]	Current [A]						
				J7MC-3P-E16	J7MC-3R-E16	0.1-0.16	50	J7KC-12	12
0.03	0.24	0.06	0.23	J7MC-3P-E25	J7MC-3R-E25	0.16-0.25			
0.06	0.37	0.09	0.32	J7MC-3P-E4	J7MC-3R-E4	0.25-0.4			
		0.12	0.5	J7MC-3P-E63	J7MC-3R-E63	0.4-0.63			
0.1	0.68	0.18	0.65	J7MC-3P-1	J7MC-3R-1	0.63-1.0			
		0.25	0.9	J7MC-3P-1	J7MC-3R-1	0.63-1.0			
0.2	1.3	0.37	1.25	J7MC-3P-1E6	J7MC-3R-1E6	1.0-1.6			
		0.55	1.6	J7MC-3P-2E5	J7MC-3R-2E5	1.6-2.5			
0.4	2.3	0.75	2	J7MC-3P-2E5	J7MC-3R-2E5	1.6-2.5			
		1.1	2.5	J7MC-3P-4	J7MC-3R-4	2.5-4.0			
0.75	3.6	1.5	3.5	J7MC-3P-4	J7MC-3R-4	2.5-4.0			
1.5	6.1	2.2	5	J7MC-3P-6	J7MC-3R-6	4.0-6.3			

Note: The 3-phase motor full load current is a reference value. When applying, check the full load current of the motor you will use.

Type 2 rated conditional short-circuit current $I_q = 50$ kA (200 VAC, 400 VAC)

3-phase motor capacity and full load current				Manual motor starter			Short-circuit current I_q [kA]	Magnetic contactor	
200 VAC		400 VAC		Model		Current setting range [A]		Model	Rated operational current AC-3 [A]
Capacity [kW]	Current [A]	Capacity [kW]	Current [A]						
				J7MC-3P-E16	J7MC-3R-E16	0.1-0.16	50	J7KC-12	12
0.03	0.24	0.06	0.23	J7MC-3P-E25	J7MC-3R-E25	0.16-0.25			
0.06	0.37	0.09	0.32	J7MC-3P-E4	J7MC-3R-E4	0.25-0.4			
		0.12	0.5	J7MC-3P-E63	J7MC-3R-E63	0.4-0.63			
0.1	0.68	0.18	0.65	J7MC-3P-1	J7MC-3R-1	0.63-1.0			
		0.25	0.9	J7MC-3P-1	J7MC-3R-1	0.63-1.0			
0.2	1.3	0.37	1.25	J7MC-3P-1E6	J7MC-3R-1E6	1.0-1.6			
		0.55	1.6	J7MC-3P-2E5	J7MC-3R-2E5	1.6-2.5			
0.4	2.3	0.75	2	J7MC-3P-2E5	J7MC-3R-2E5	1.6-2.5			
		1.1	2.5	J7MC-3P-4	J7MC-3R-4	2.5-4.0			
0.75	3.6	1.5	3.5	J7MC-3P-4	J7MC-3R-4	2.5-4.0			

Note: The 3-phase motor full load current is a reference value. When applying, check the full load current of the motor you will use.

Rated combination table and SCCR for North America

220-240 V		440-480 V		Manual motor starter			Magnetic contactor	Short-circuit current rating SCCR [kA]
Rated capacity [Hp]	Rated operational current [A]	Rated capacity [Hp]	Rated operational current [A]	Model		Current setting range [A]	Model	
*	0.16	*	0.16	J7MC-3P-E16	J7MC-3R-E16	0.1-0.16	J7KC-12	65 kA
	0.25		0.25	J7MC-3P-E25	J7MC-3R-E25	0.16-0.25		65 kA
	0.4		0.4	J7MC-3P-E4	J7MC-3R-E4	0.25-0.4		65 kA
	0.63		0.63	J7MC-3P-E63	J7MC-3R-E63	0.4-0.63		65 kA
	1		1	J7MC-3P-1	J7MC-3R-1	0.63-1.0		65 kA
	1.6		3/4	1.6	J7MC-3P-1E6	J7MC-3R-1E6		1.0-1.6
1/2	2.2	1	2.1	J7MC-3P-2E5	J7MC-3R-2E5	1.6-2.5		65 kA
3/4	3.2	2	3.4	J7MC-3P-4	J7MC-3R-4	2.5-4		65 kA
1-1/2	6	3	4.8	J7MC-3P-6	J7MC-3R-6	4-6.3		65 kA
		5	7.6	J7MC-3P-10	J7MC-3R-10	6.3-10		25 kA
3	9.6			J7MC-3P-10	J7MC-3R-10	6.3-10		25 kA
		7-1/2	11	J7MC-3P-13	J7MC-3R-13	9-13		10 kA

* An area where horsepower is not defined in UL60947-4-1 (SCCR is acquired in this area)

J7KC Series

Options (Order Separately)

Auxiliary contact unit

J73KC

Ratings



Conventional free air thermal current (rated flowing current) [A]	Contact closed and Breaking current [A]	AC			DC			Minimum operate voltage/current
		Operating voltage [V]	Rated operational current (A)		Operating voltage [V]	Rated operational current (A)		
			Coil load (AC-15)	Resistive load (AC-12)		Coil load (DC-13)	Resistive load (DC-12)	
10	30	100 to 120 AC	3	6	24 DC	2	3	5 VDC, 3 mA
	30	200 to 240 AC	3	6	48 DC	1	2	
	10	380 to 440 AC	1	6	110 DC	0.3	1.5	
	5	500 to 600 AC	0.5	3	220 DC	0.2	0.5	

Connection diagram

Model	Contact configuration	Model	Contact configuration
J73KC-AM-40	4PST-4NO (4NO) 	J73KC-AM-04	4PST-4NC (4NC)
J73KC-AM-31	4PST-3NO 1NC (3NO1NC) 	J73KC-AM-20	2PST-2NO (2NO)
J73KC-AM-22	4PST-2NO 2NC (2NO2NC) 	J73KC-AM-11	2PST-1NO 1NC (1NO1NC)
J73KC-AM-13	4PST-1NO 3NC (1NO3NC) 	J73KC-AM-02	2PST-2NC (2NC)

Dimensions

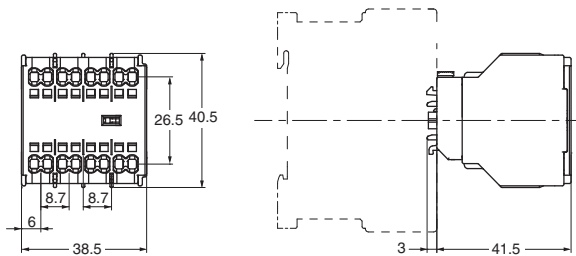

Interlock unit

J74KC

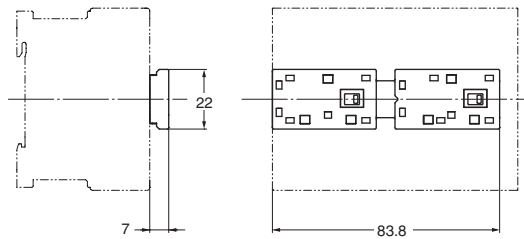

Reversing conductor kit

J75KC-WKR-A

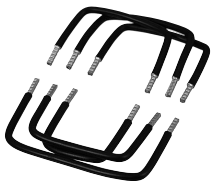

For power supply side

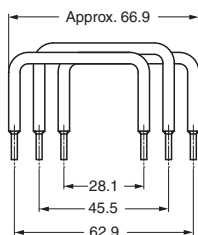

For load side

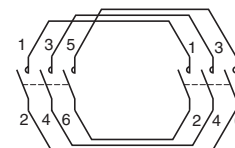
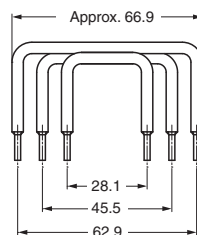

J75KC-WKR-B



For power supply side

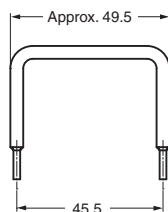

For load side

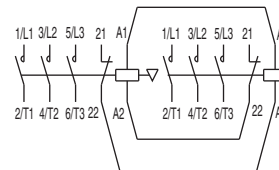
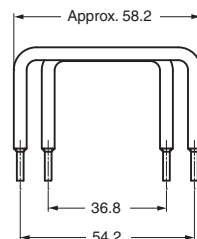

Coil surge absorption unit

Ratings

Model	Surge absorber	Varistor voltage	LED indicator	Applicable model		Control circuit voltage	
				AC operated	DC operated	AC	DC
J76KC-RC-1	Varistor	100 V	---	J7KC-□-AC	---	24-48 VAC	Not required *
J76KC-RC-2		240 V				48-125 VAC	
J76KC-RC-3		470 V				100-250 VAC	
J76KC-RC-N-1	100 V	24-48 VAC					
J76KC-RC-N-2	240 V	48-125 VAC					

* The DC operated (J7KC-□-DC) has a varistor built into the main unit.

Dimensions

J76KC-RC

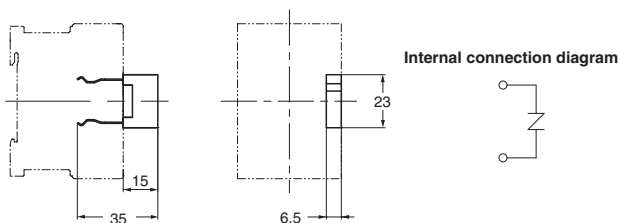

J76KC-RC-N

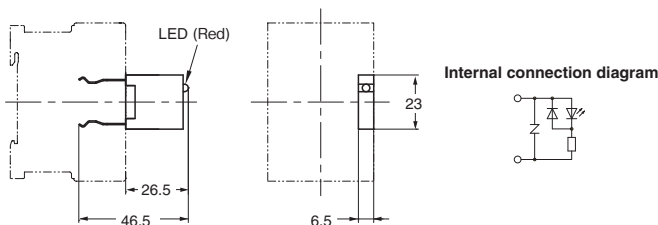

J7KC Series

Insulation stop J77KC-K

Guide for insertion into terminal (insertion) holes to stabilize holding of 1mm² or less stranded wire (direct insertion).

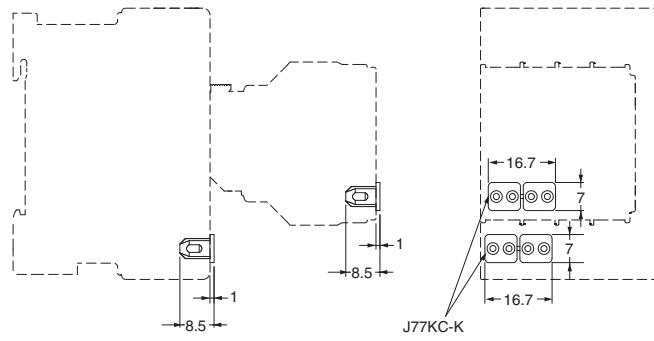

Tools for removal J78KC

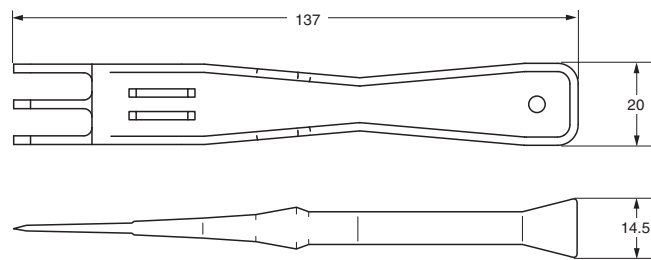

DIN Rails (Order Separately)

(Unit: mm)

Mounting Rail
PFP-100N
PFP-50N

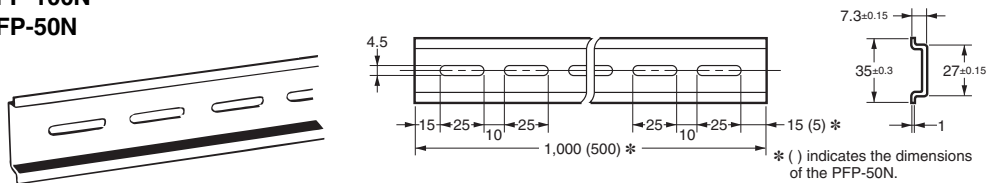

Model
PFP-100N
PFP-50N

Mounting Rail
PFP-100N2

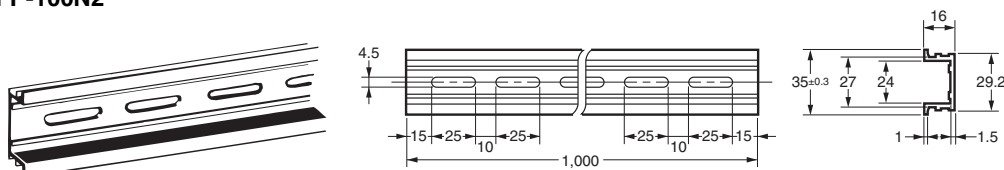

Model
PFP-100N2

End Plate
PFP-M

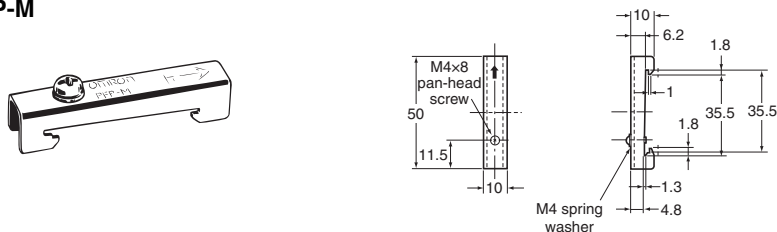

Model
PFP-M

Spacer
PFP-S

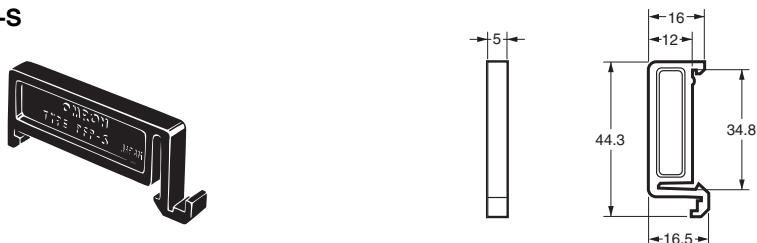

Model
PFP-S





Note: 1. Order the parts above in units of ten. The prices shown above are standard prices for one piece.
2. Rails conform to DIN standards.

Safety Precautions

Warning Indications

 CAUTION	Indicates a potentially hazardous situation which, if not avoided, is likely to result in minor or moderate injury or property damage.
Precautions for Safe Use	Supplementary comments on what to do or avoid doing, to use the product safely.
Precautions for Correct Use	Supplementary comments on what to do or avoid doing to prevent failure to operate, malfunction, or undesirable effects on product performance.

Meaning of Product Safety Symbols

	Used to warn of the risk of electric shock under specific conditions.
	Used to indicate prohibition when there is a risk of minor injury from electric shock or other source if the product is disassembled.
	Used for general prohibitions for which there is no specific symbol.
	Used for general mandatory action precautions for which there is no specified symbol.

CAUTION

Do not touch or approach the product while or immediately after power is supplied. Electric shock or burn injuries may occur.



Never disassemble, modify, or repair the product or touch any of the internal parts. Minor electric shock, fire, or malfunction may occasionally occur.



Do not use the product in an environment where flammable or explosive gas is present.



Relay life expectancy varies considerably with output load and switching conditions. Always consider the application conditions and use within the rated load and electrical life expectancy.



Precautions for Safe Use

- Do not use the product in any of the following locations.
 - Places subject to intense temperature changes
 - Places subject to high humidity or condensation
 - Places subject to intense vibration or shock
 - Places subject to considerable dust or corrosive gas, or directly exposed to sunlight
 - Places subject to splashing water, oil, or chemicals.
- Using the product in a place where there is an intense magnetic field may result in malfunctioning.
- Do not store or use in conditions that subject the product to an external load.
- The product has an internal permanent magnet. Do not bring other products that are susceptible to the effects of magnetism close to the product, or store together with the product.
- Securely mount the product on the rail.
- When mounting on a rail, use the end plate.
- Never drop the product or allow it to fall.
- Make sure that foreign matter does not collect or enter into the terminal (insertion) hole or release hole. Smoking or ignition, malfunctioning, or failure may occur.
- Do not use the product at less than the minimum applicable load.
- Never use at a load that exceeds the rated capacity.
- Select the coil specifications correctly.
- When using an AC current coil, malfunction or damage of the connected device may result due to the occurrence of a current surge.
 - Be sure to use a surge absorption Unit.
- For the coil, do not use a power supply that is also connected to a solenoid or similar device.
- Do not use an inverter power supply for the coil.
- Do not apply a voltage greater than the maximum allowable voltage to the coil.
- Use wire, ferrules, and tools with the required specifications. Strip the wires to the specified length, and use ferrules of the specified length. Insert all the way into the terminal (insertion) hole until the wire tip contacts the back.
 - (For details, refer to the information on pages 20 and 21.)
- If directly inserting wire, always use tin-plated strand wire.
- Do not insert multiple wires into one terminal (insertion) hole.
- Do not wire terminals that are not used.
- Make sure all wiring connections are correct before supplying power.
- Do not accidentally insert a wire into the release hole.
- Do not bend a wire past its natural bending radius or pull on it with excessive force.
- After inserting the tool into the release hole, do not pry with the tool.
- Do not insert the tool into the terminal (insertion) hole.
- Do not supply power while the tool is inserted into the release hole.
- Do not insert anything other than the specified tool into the release hole.
- When replacing the magnetic contactor/auxiliary relay, also replace the surge absorption unit at the same time.
- Wipe off any dirt from the product with a soft dry cloth. Never use thinners, benzene, alcohol, or any cleaners that contain these or other organic solvents. Deformation or discoloration may occur.
- When disposing of the product, follow local disposal procedures for industrial waste.

Precautions for Correct Use

- Check the terminal polarity and wire correctly.
- If the power voltage fluctuates, ensure that enough voltage is applied to the coil to enable each connector to fully operate.
- Avoid use in a location with many magnetic particles. Risk of failure.
- Follow the procedure in the datasheet to securely install the Unit on the main Unit.

Mounting, removal and wiring (connection)

Mounting on rail

Follow the procedures below to mount the product on the rail or remove it from the rail.

[Mounting]

- (1) Tilt the product about 10° with respect to the rail. Engage the hook at the power supply side and gently push the product down.
- (2) Press the product against the rail.
- (3) Lift the product up to engage the hook at the load side with the rail.
- (4) Gently jiggle the product to check that the load-side hook is engaged with the rail.

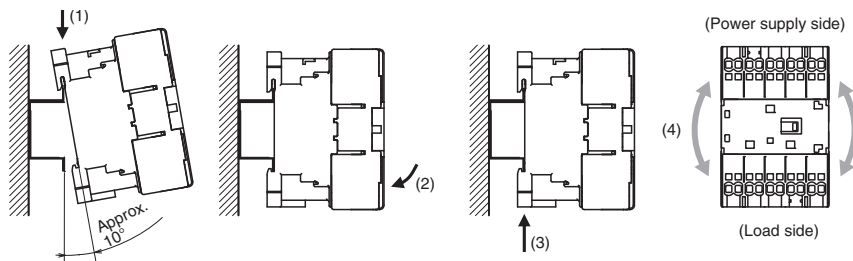

When mounting on a rail, use the end plate.

Removing from rail

- (1) Hold the product at the top and bottom. Push it downward to release the lower hook.
- (2) Remove the product.

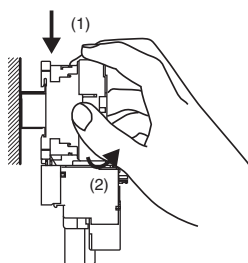

Mounting angle

Appearance					
Mounting direction	Standard mounting	Inclined mounting	Sideways mounting		Horizontal mounting
	---	30°	Coil upwards	Coil downwards	Terminals upwards
J7KC-12-□ AC□	X	X	X	*1	X
J7KC-12-□ DC□	X	X	*2	X	X

*1. Allowable voltage fluctuation range is 90% to 110%.

*2. Release (open) voltage is 5% to 70%.

Installation interval

Mount with a separation of at least the dimension shown in the diagram.

When mounting products close together, comply with the standards below for the rated operational current and rated flowing current in the Characteristics table on pages 6 to 7. Increased temperature under some operating conditions (closely mounted products that are energized continuously or have a high switching frequency) may reduce the life of the coil.

Main circuit: If 9 A is exceeded, 9 A max.

Auxiliary circuit: If 7 A is exceeded, 7 A max.

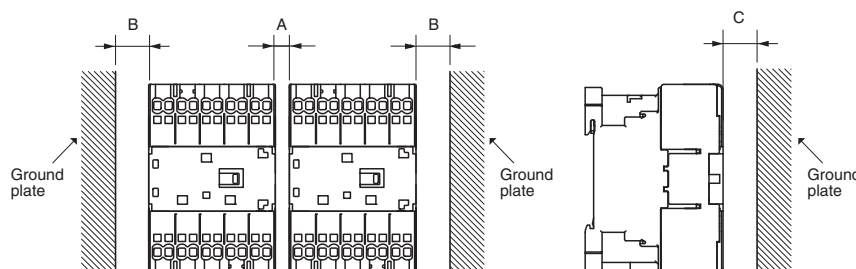

A (mm)	B (mm)	C (mm)
0	10	*

* Set dimension C to an adequate distance for wiring. If the wires have to be bent in a small space, check the minimum bending dimensions with the wire manufacturer before connecting the wiring.

Wiring

Wire with ferrule

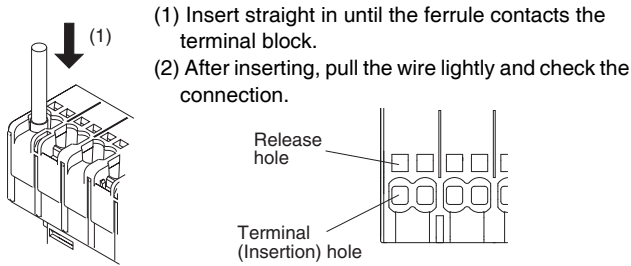

- (1) Insert straight in until the ferrule contacts the terminal block.
- (2) After inserting, pull the wire lightly and check the connection.

Stranded wire (direct insertion)

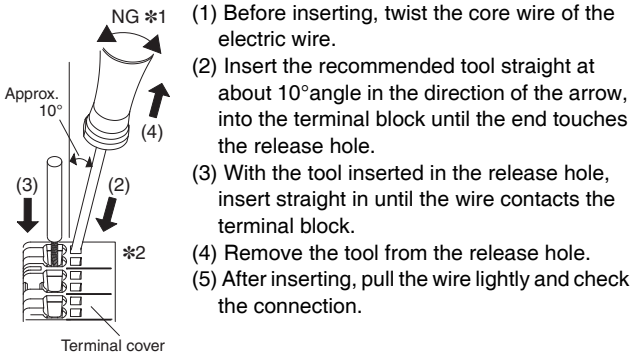

- (1) Before inserting, twist the core wire of the electric wire.
- (2) Insert the recommended tool straight at about 10° angle in the direction of the arrow, into the terminal block until the end touches the release hole.
- (3) With the tool inserted in the release hole, insert straight in until the wire contacts the terminal block.
- (4) Remove the tool from the release hole.
- (5) After inserting, pull the wire lightly and check the connection.

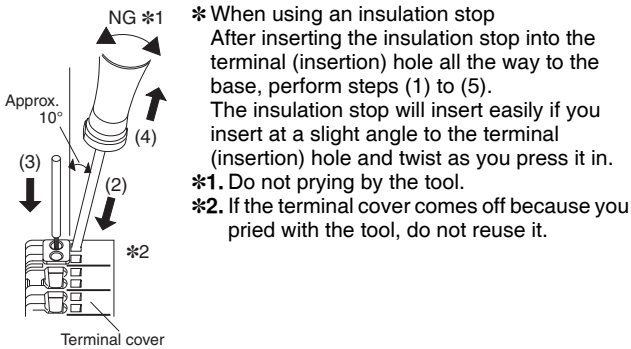

- * When using an insulation stop
After inserting the insulation stop into the terminal (insertion) hole all the way to the base, perform steps (1) to (5). The insulation stop will insert easily if you insert at a slight angle to the terminal (insertion) hole and twist as you press it in.
- *1. Do not prying by the tool.
 - *2. If the terminal cover comes off because you pried with the tool, do not reuse it.

Removing wire

Common for electric wires with ferrules and stranded wires (direct insertion)

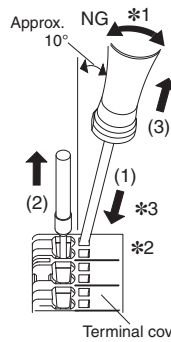

- (1) Insert the recommended tool straight at about 10° angle in the direction of the arrow, into the terminal block until the end touches the release hole.
- (2) With the tool still inserted into the release hole, remove the wire from the terminal insertion hole.
- (3) Remove the tool from the release hole.

- *1. Do not prying by the tool.
- *2. If the terminal cover comes off because you pried with the tool, do not reuse it.
- *3. The inside of the release hole is electrically live. Electric shock may result. Do not use a screwdriver with a metal handle. Do not touch the metal part of the tool.

Connection method and application size of the electric wire

- If directly inserting wire, always use tin-plated strand wire.
- Crimp the ferrule for stranded wires that are not tin plated.
- Solid wire and bar terminals cannot be used.

Applicable wire sizes

Applicable wire		Ferrules used				Stranded wires (direct insertion) *4		
		With an insulation sleeve (L = 8 mm, 10 mm)		Without an insulation sleeve (L = 10 mm)				
(mm ²)	(AWG)	Size (mm ²)	Main circuit	Auxiliary/control circuit	Main circuit	Auxiliary/control circuit	Main circuit	Auxiliary/control circuit
0.5	20	0.5	---	⊙	---	⊙	---	⊙ (*3)
0.75	18	0.75	⊙	⊙	⊙	⊙	⊙	⊙
1		1	⊙	⊙	⊙	⊙	⊙ (*3)	⊙ (*3)
1.25	16	1.5	⊙	⊙	⊙	⊙	⊙	⊙
1.5			⊙	⊙	⊙	⊙	⊙	⊙
2	14	2 (*2)	⊙	⊙	⊙	⊙	⊙	---
2.5		2.5	⊙	⊙	⊙	⊙	⊙	---

⊙: 2 wires allowed (simultaneous connection for crossover wiring terminals),
 ○: 1 wire allowed, -: out of specification

- *1. For compliance with UL or CSA standards, you must use wires of the following sizes.
 Main circuit: 14AWG
 Auxiliary circuit: 16 AWG to 14 AWG
- *2. Connection is only possible using 2 mm² FE-2.08-8N-YE and FE-2.08-10N-YE ferrules with insulation sleeves manufactured by Wago.
- *3. Use an insulation stop.
 (Insulation stops cannot be used with ferrules.)
 Do not use an insulation stop in empty terminals.
- *4. Insulation stripping length for stranded wires (direct insertion) is as follows.
 0.5 mm² to 1.0 mm²(20AWG to 18AWG): 12 mm ± 1 mm
 1.25 mm² to 2.5 mm²(16AWG to 14AWG): 11 mm ± 1 mm
 When using ferrules, refer to the table of recommended ferrules.

Recommended Ferrules and Crimp Tools

Recommended ferrules

Applicable wire		Ferrule conductor length (mm)	Recommended ferrules							
(mm ²)	(AWG)		With an insulation sleeve				Without an insulation sleeve			
			Insulation stripping length (mm)	Phoenix Contact	Weid muller	Wago	Insulation stripping length (mm)	Phoenix Contact	Weid muller	Wago
0.5	20	8	10	Al 0,5-8	H0.5/14	FE-0.5-8N-WH	---	---	---	---
		10	12	Al 0,5-10	H0.5/16	FE-0.5-10N-WH	10	A 0,5-10	H0.5/10	F-0.5-10
0.75	18	8	10	Al 0,75-8	H0.75/14	FE-0.75-8N-GY	---	---	---	---
		10	12	Al 0,75-10	H0.75/16	FE-0.75-10N-GY	10	A 0,75-10	H0.75/10	F-0.75-10
1/1.25	18/17	8	10	Al 1-8	H1.0/14	FE-1.0-8N-RD	---	---	---	---
		10	12	Al 1-10	H1.0/16	FE-1.0-10N-RD	10	A 1-10	H1.0/10	F-1.0-10
1.25/1.5	17/16	8	10	Al 1,5-8	H1.5/14	FE-1.5-8N-BK	---	---	---	---
		10	12	Al 1,5-10	H1.5/16	FE-1.5-10N-BK	10	A 1,5-10	H1.5/10	F-1.5-10
2	14	8	10	Al 2,5-8	H2.5/15D	FE-2.08-8N-YE	---	---	---	---
						FE-2.5-8N-BU				
		10	12	Al 2,5-10	---	10	FE-2.08-10N-YE	---	H2.5/10	F-2.5-10
					FE-2.5-10N-BU					
2.5	14	10	12	---	---	---	10	---	H2.5/10	F-2.5-10
		12	14	---	---	---	---	---	---	---
Recommended crimp tool				CRIMPFOX 6 CRIMPFOX 6T-F CRIMPFOX 10S	PZ6 roto	Variocrimp4		CRIMPFOX 6 CRIMPFOX 6T-F CRIMPFOX 10S	PZ6 roto	Variocrimp4

* Make sure that the outer diameter of the wire coating is smaller than the inner diameter of the insulation sleeve of the recommended ferrule.

Ferrule processing dimensions

Dimension (after processing)	Main circuit		Auxiliary/control circuit		
	Minimum	Maximum	Minimum	Maximum	
L[mm]	0	0.5	0	0.5	
D[mm]	Less than 2.5		Less than 2.5		
Wire size	[mm ²]	0.75	2	0.5	1.5
	[AWG]	18	14	20	16

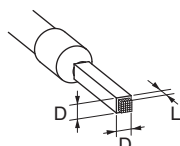

Recommended Flat-blade Screwdriver (Recommended tool)

Use a flat-blade screwdriver to connect and remove wires. Use the flat-blade screwdriver shown in the table below. The following table shows manufacturers and models as of 2018/Dec.

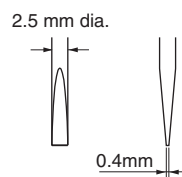

Model	Manufacturer
ESD 0,40x2,5	Wera
SZS 0,4x2,5 SZF 0-0,4x2,5 *	Phoenix Contact
0.4x2.5x75 302	Wiha
AEF.2,5x75	Facom
210-719	Wago
SDIS 0.4x2.5x75	Weidmuller
9900 (-2.5x75)	Vessel

* OMRON's exclusive purchase model XW4Z-00B is available to order as SZF 0-0,4x2,5 (manufactured by Phoenix Contact).

Voltage fluctuation range and voltage drop in control circuit

- AC-operated (J7KC-□-AC)

Must operate voltage: 85% to 110% of rated voltage

However, this is the rated voltage for making. It can be used with no concern about contact welding even if the voltage drops to 75% of the rated voltage when the main contacts are closed.

- DC-operated (J7KC-□-DC)

Must operate voltage: 85% to 110% of rated voltage (55°C ambient temperature), 80 to 110% (40°C ambient temperature)

However, this is the rated voltage for making. It can be used with no concern about contact welding even if the voltage drops to 75% of the rated voltage when the main contacts are closed.

J7KC Series

Connection to peripherals

(1) AC-operated models

The control coil of AC-operated models does not contain a built-in surge absorber. Use an optional coil surge absorption unit if required.

(2) DC-operated models

The control coil of DC-operated models contains a built-in surge absorber (varistor). Therefore, it is not necessary to connect an external surge absorption circuit in a normal sequence circuit. (See Table 1)

Connect the control coil terminals and various DC output devices as shown in Table 2.

Note that the control coil terminals have A1 (plus) and A2 (minus) polarities.

Table 1. Coil voltages and varistor voltages of DC-operated

Coil voltage [V]	Varistor voltage [V]
12	39
24	
48	
60	240
100	
110	
120	
200	470
210	
220	

Table 2. Connection of control coil terminals and peripherals for DC-operated

Device output form	Without protective diode	With built-in protective diode		
Connection method				
Example of device	Various DC output models	NPN output photoelectric switch, proximity switch, etc.	PNP output photoelectric switch, proximity switch, etc.	Programmable controller, etc.
Precautions	Use an output transistor with a dielectric strength of at least (coil surge voltage + output power supply voltage).	---	---	The release time is extended due to the built-in protective diode.

Coil surge absorption characteristics

AC operated	Application	Coil surge absorption characteristics (200 VAC coil)
Without surge absorption unit	Due to the sudden current change when the coil turns off, a steep surge voltage is generated from the coil due to the coil inductance, and this becomes noise in the peripheral electronic equipment that may cause a malfunction or circuit damage.	J7KC-□-AC (0.1 ms/div, 1 kV/div)
Varistor	When the surge voltage reaches or exceeds a certain level, current flows through the varistor connected in parallel with the coil, which has the effect of controlling the peak wave of the surge voltage. The varistor can be used in AC or DC circuits. The suppression surge voltage is approximately the varistor voltage.	J7KC-□-AC+J7K6C-RC-3 (2 ms/div, 200 V/div)

DC operated	Application	Coil surge absorption characteristics (24 VDC coil)
Varistor (Built into main unit)	When the surge voltage reaches or exceeds a certain level, current flows through the varistor connected in parallel with the coil, which has the effect of controlling the peak wave of the surge voltage.	J7KC-□-DC (Built into varistor) (0.1 ms/div, 1 kV/div)

Installing of the thermal overload relay

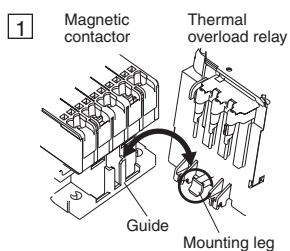

Insert the mounting legs of the thermal overload relay into the guides in the magnetic contactor, and insert the connecting wires into the terminal (insertion) holes.

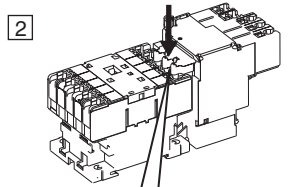

Please push the position of the arrow till the last.

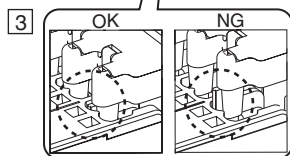

Please insert it until a projection hides.

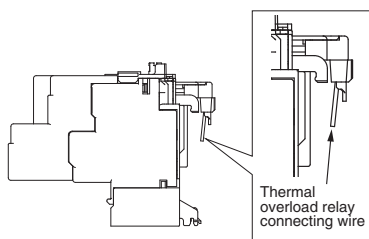

- * The connecting wires are manufactured at an angle. Be sure not to change the shape of the connecting wires.
- * Thermal overload relays cannot be used for auxiliary relays.

Removing of the thermal overload relay

Follow the procedure below to remove the thermal overload relay with the removal tool (J78KC, order separately).

- (1) Insert the removal tool into the release hole.
- (2) Pull out the thermal overload relay in the direction of the arrow while the removal tool is still inserted.
- (3) Pull out the removal tool.

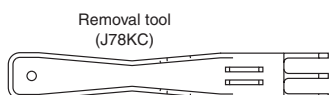
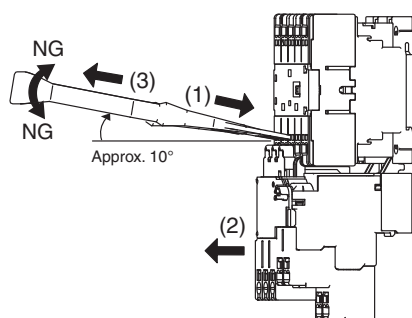

Mounting or removing the auxiliary contact unit

- To mount the unit, tilt it with respect to direction (1) and press it against the main unit, engage hook 1 of the unit with the mounting groove, rotate it in direction (2), and check that hook 2 is securely engaged with the main unit.

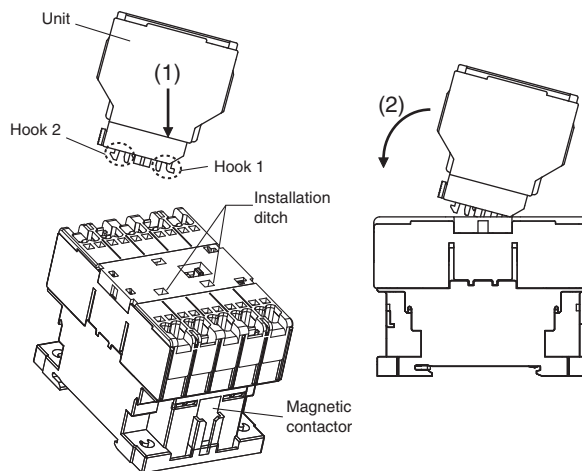

Fig 1. Mounting method

- To remove the unit, press in hook 2 of the unit between your fingers and rotate it in direction (3) to unlock and remove the unit.

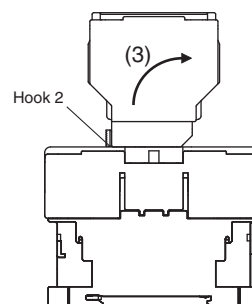

Fig 2. Removal method

Mounting space

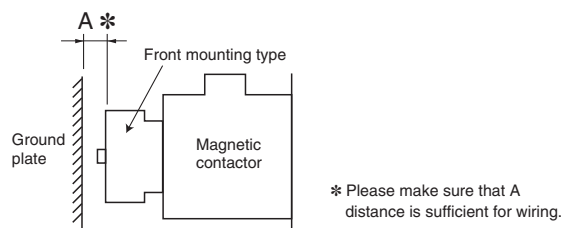
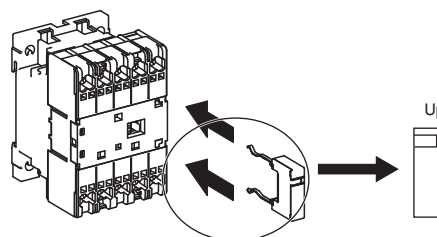

Diagram 3. Mounting space

* Please make sure that A distance is sufficient for wiring.

Mounting the coil surge absorption unit

Push the unit into the mounting holes in the Magnetic contactor. The unit has a defined vertical orientation. Do not mount it upside down.



How to assemble a reversing magnetic contactor using an interlock unit and reversing conductor kit

Interlock unit

1. Connect two magnetic contactors with two connecting pieces (1).
2. Move the protrusion (2) on the movable part of the interlock unit to the right.
3. Insert them from directly above to match the protrusion (3) on the movable part of the main unit.
4. After installation, slide the left and right indicator projections one at a time to confirm that they move smoothly.
5. After installation, the interlock unit cannot be removed again. (The interlock unit has a structure that makes it difficult to remove once installed.)

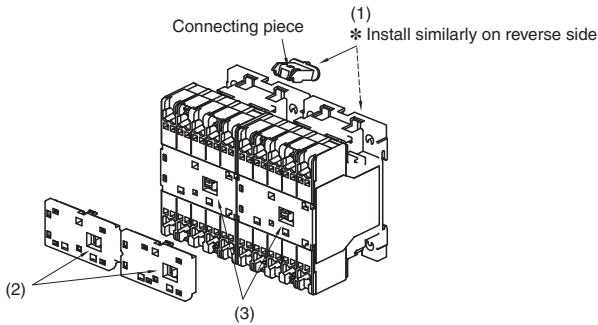

Reversing conductor kit

Attach to the main circuit terminals. Conductors are available for the power supply side and load side. Be sure to install them correctly.

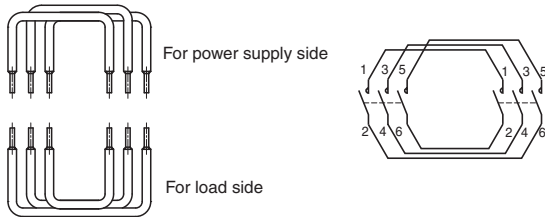

- *1. To prevent a short-circuit accident when using the reversing conductor kit for rapid switching, use an electrical interlock with a delay relay to ensure a contact switching time in the two magnetic contactors of at least 15 ms.
- *2. Provide an electrical interlock between the forward and reverse control circuits.

Electrical detection

Electricity can be detected by inserting a detector in the release hole. When inserting a detector, insert it gently while checking for electrical signals. The wire may pull out if the detector is fully inserted. After detection is complete, immediately pull out the detector and check that the wire is still firmly connected.

Mirror Contact Mechanism

With the combination of the main circuit and the auxiliary circuit of the main unit, welding the main contacts will result in a structure that secures a shock resistance voltage of 2.5 kV or more, or a contact interval of 0.5 mm or more, for all of the auxiliary circuit NC contacts even if the excitation of the coil is released. The main contact may turn on even if the auxiliary circuit is welded.

Description of Mirror Contact Mechanism

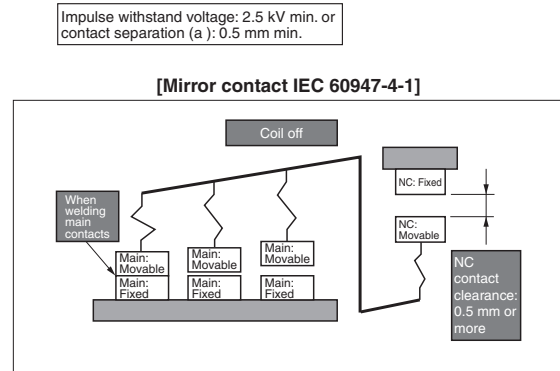

Safety Function with Mirror Contacts

The J7KC acquired EN 60947-4-1 certification for mirror contact mechanisms, enabling application in feedback circuits of safety circuits.

Application Example: General Safety Circuit

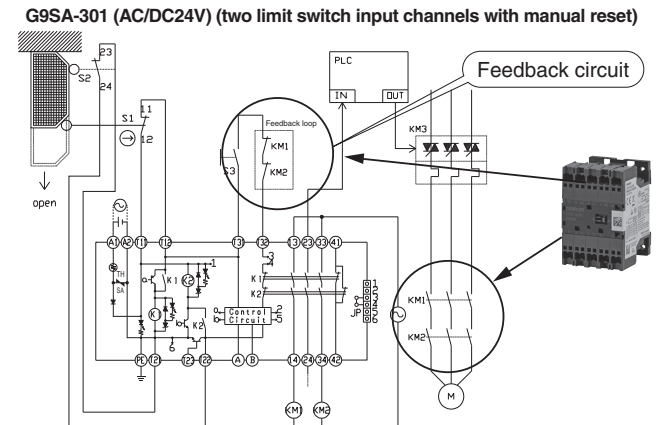

Recommended replacement period

Magnetic contactors and switches have a wear life according to the number of switching cycles of their main contacts and mechanical parts. The coil wiring and electronic parts in the electronic unit have a service life resulting from deterioration due to the operating environment and conditions.

You are recommended to replace magnetic contactors and switches after the rated number of switching cycles specified in the catalog, or 10 years after the date of manufacture according to the standard conditions of operation described in the "Survey on Low-voltage Equipment Update Recommendation Times" report prepared by the Japan Electrical Manufacturers' Association (JEMA).