

The documentation and process conversion measures necessary to comply with this revision shall be completed by 6 December 2013.

INCH-POUND

MIL-PRF-19500/420M  
6 September 2013  
SUPERSEDING  
MIL-PRF-19500/420L  
27 June 2008

PERFORMANCE SPECIFICATION SHEET

SEMICONDUCTOR DEVICE, DIODE, SILICON, POWER, RECTIFIER,  
TYPES 1N5550 THROUGH 1N5554, 1N5550US THROUGH 1N5554US,  
JAN, JANTX, JANTXV, JANS, JANHCA, JANHCB, JANHCC, JANHCD,  
JANHCE, JANKCA, JANKCD, AND JANKCE

This specification is approved for use by all Departments and Agencies of the Department of Defense.

The requirements for acquiring the product described herein shall consist of this specification sheet and [MIL-PRF-19500](#).

1. SCOPE

1.1 Scope. This specification covers the performance requirements for silicon, general purpose, semiconductor diodes. The diode is non cavity double plug construction, with high temperature metallurgical bonds (category 1) between both sides of the silicon die and terminal pins. Four levels of product assurance are provided for each encapsulated device type as specified in [MIL-PRF-19500](#). Two levels of product assurance are provided for each unencapsulated device type.

1.2 Physical dimensions. See [figure 1](#) (axial lead) for 1N5550 through 1N5554, [figure 2](#) for 1N5550US through 1N5554US, and [figures 3, 4, 5, 6, and 7](#) for JANHC and JANKC die.

1.3 Maximum ratings. Unless otherwise specified,  $T_A = +25^\circ\text{C}$  and ratings apply to all case outlines.

1.3.1 Ratings applicable to all types.  $T_{STG} = T_J = -65^\circ\text{C}$  to  $+175^\circ\text{C}$ .

\* 1.3.2 Ratings applicable to individual types.

Col. 1	Col. 2	Col. 3	Col. 4	Col. 5	Col. 6	Col. 7	Col. 8	Col. 9
Type (1)	$V_{RWM}$	$I_{O(L)}$ $T_L = +30^\circ\text{C}$ ; $L = .375$ inch (1) $T_{EC} = 130^\circ\text{C}$	$I_{O2}$ $T_A =$ $55^\circ\text{C max}$ (2) (3)	$I_{O3}$ $T_A =$ $100^\circ\text{C}$ (3) (4)	$I_{FSM}$ $I_O = 2$ A dc $t_p = 8.3$ ms $V_{RWM} =$ Rated $T_A = 55^\circ\text{C}$	$R_{\theta JL}$ at $L = .375$ inch (9.52 mm) (5)	$R_{\theta JEC}$ at $L = 0$ inch (0 mm) (6)	$R_{\theta JX}$ (3)
	<u>V dc</u>	<u>A</u>	<u>A</u>	<u>A dc</u>	<u>A(pk)</u>	<u>°C /W</u>	<u>°C /W</u>	<u>°C /W</u>
1N5550, US	200	5	3.0	2.0	100	22	6.5	47
1N5551, US	400	5	3.0	2.0	100	22	6.5	47
1N5552, US	600	5	3.0	2.0	100	22	6.5	47
1N5553, US	800	5	3.0	2.0	100	22	6.5	47
1N5554, US	1,000	5	3.0	2.0	100	22	6.5	47

See notes on next page.

\* Comments, suggestions, or questions on this document should be addressed to DLA Land and Maritime, ATTN: VAC, P.O. Box 3990, Columbus, OH 43218-3990, or emailed to [Semiconductor@dla.mil](mailto:Semiconductor@dla.mil). Since contact information can change, you may want to verify the currency of this address information using the ASSIST Online database at <https://assist.dla.mil/>.

1.3.2 Maximum ratings. – Continued.

- (1) Barometric pressure reduced: 1N5550, 1N5551, 1N5552: 8 mm Hg (100,000 feet);  
1N5553, 1N5554: 33 mm Hg (70,000 feet).
- (2) Derate linearly at 22.2 mA/°C from +55°C +100°C
- (3) For the 3A rating at 55°C ambient and the 2A rating at 100°C ambient, these  $I_O$  ratings are for a thermally (PC boards or other) mounting methods where the lead or end-cap temperatures cannot be maintained as shown in col. 3 and where thermal resistance from mounting point to ambient is still sufficiently controlled where  $T_{J(MAX)}$  in 1.3.1 is not exceeded. This equates to  $R_{\theta JX} \leq 47^\circ\text{C/W}$  in col. 9. Also see application notes in 6.5.1.
- (4) Derate linearly at 26.7mA/°C above  $T_L = +100^\circ\text{C}$  to +175°C ambient.
- \* (5) See figure 8.
- \* (6) See figure 9.

1.4 Primary electrical characteristics. Unless otherwise specified,  $T_A = +25^\circ\text{C}$ .

Type	$V_{F1}$ at $I_F = 9.0$ A(pk) 1 percent duty cycle, 8.3 ms max pulse width		$I_{R1}$ , pulsed $V_R \leq 20$ ms		$I_{R2}$ at $T_A = +125^\circ\text{C}$ , pulsed $V_R \leq 20$ ms	
	<u>Min V(pk)</u>	<u>Max V(pk)</u>	<u><math>\mu\text{A dc (max) at } V_R \text{ (V dc)}</math></u>		<u><math>\mu\text{A dc (max) at } V_R \text{ (V dc)}</math></u>	
1N5550, US	0.6	1.2	1.0	200	60	200
1N5551, US	0.6	1.2	1.0	400	60	400
1N5552, US	0.6	1.2	1.0	600	60	600
1N5553, US	0.6	1.3	1.0	800	60	800
1N5554, US	0.6	1.3	1.0	1,000	60	1,000

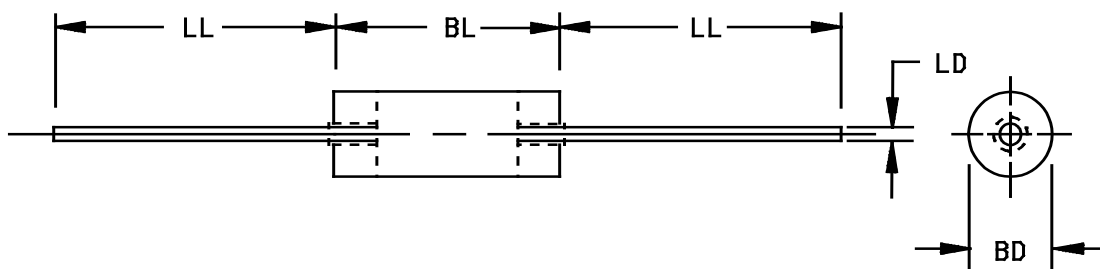

Ltr	Dimensions				Notes
	Inches		Millimeters		
	Min	Max	Min	Max	
BD	.115	.180	2.92	4.57	3, 4
BL	.130	.300	3.30	7.62	4
LD	.036	.042	0.92	1.07	
LL	.900	1.300	22.86	33.02	

## NOTES:

1. Dimensions are in inches.
2. Millimeter equivalents are given for general information only.
3. The BL dimension shall include the entire body including slugs and sections of the lead over which the diameter is uncontrolled. This uncontrolled area is defined as the zone between the edge of the diode body and extending .050 inch (1.27 mm) onto the leads.
4. Dimension BD shall be measured at the largest diameter.
5. In accordance with ASME Y14.5M, diameters are equivalent to  $\phi x$  symbology.

FIGURE 1. Physical dimensions of diode 1N5550 through 1N5554.

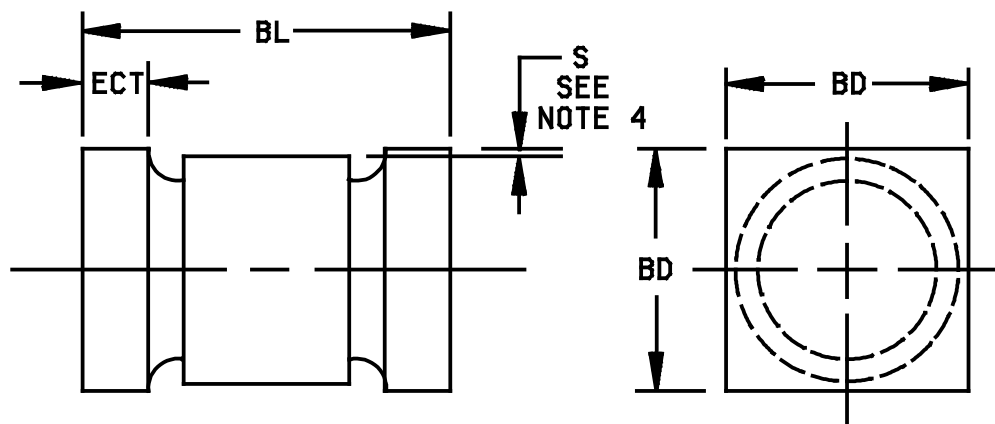

Ltr	Dimensions			
	Inches		Millimeters	
	Min	Max	Min	Max
BL	.200	.275	5.08	6.99
BD	.137	.186	3.48	4.72
ECT	.019	.034	0.48	0.86
S	.003		0.08	

NOTES:

1. Dimensions are in inches.
2. Millimeters are given for general information only.
3. Dimensions are pre-solder dip.
4. Minimum clearance of glass body to mounting surface on all orientations.
5. In accordance with ASME Y14.5M, diameters are equivalent to  $\phi x$  symbology.

FIGURE 2. Physical dimensions of 1N5550US through 1N5554US.

MIL-PRF-19500/420M

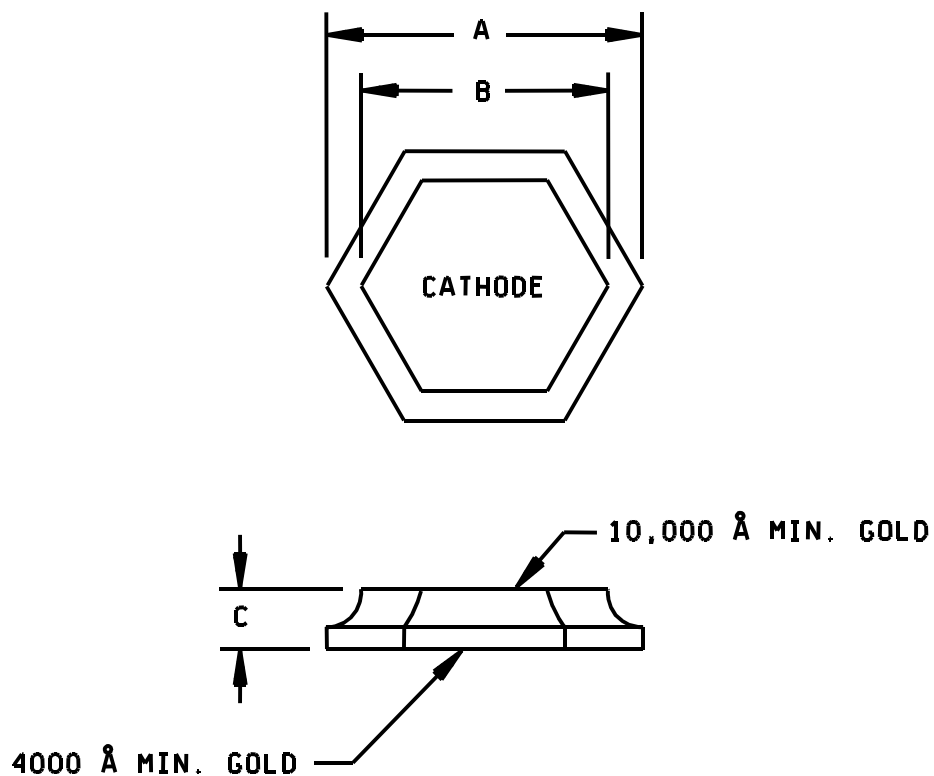

Ltr	Dimensions			
	Inches		Millimeters	
	Min	Max	Min	Max
A	.085	.091	2.16	2.31
B	.072	.078	1.83	1.98
C	.008	.014	0.20	0.36

NOTES:

1. Dimensions are in inches.
2. Millimeters are given for general information only.
3. The physical characteristics are:  
 Top (cathode) Au Thickness = 10,000Å minimum,  
 Back (anode) Au Thickness = 4,000Å minimum.
4. In accordance with ASME Y14.5M, diameters are equivalent to  $\phi x$  symbology.

FIGURE 3. JANHCA and JANKCA (A-version) die dimensions.

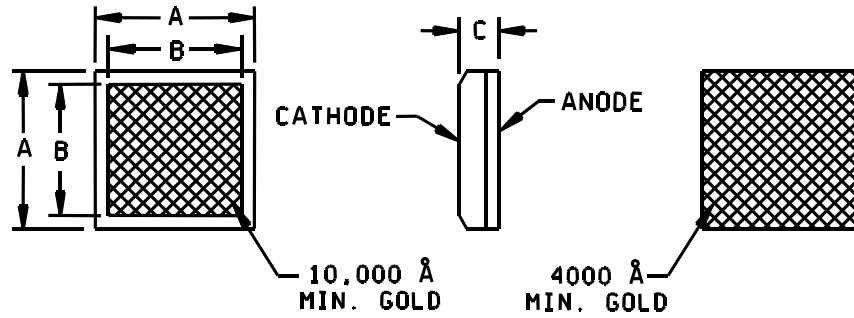

Ltr	Dimensions			
	Inches		Millimeters	
	Min	Max	Min	Max
A	.088	.092	2.24	2.34
B	.070	.077	1.78	1.96
C	.007	.035	0.18	0.89

NOTES:

1. Dimensions are in inches.
2. Millimeters are given for general information only.
3. The physical characteristics are  
 Top (cathode) Au Thickness = 10,000Å minimum,  
 Back (anode) Au Thickness = 4,000Å minimum.
4. In accordance with ASME Y14.5M, diameters are equivalent to  $\phi x$  symbology.

FIGURE 4. JANHCB (B-version) die dimensions.

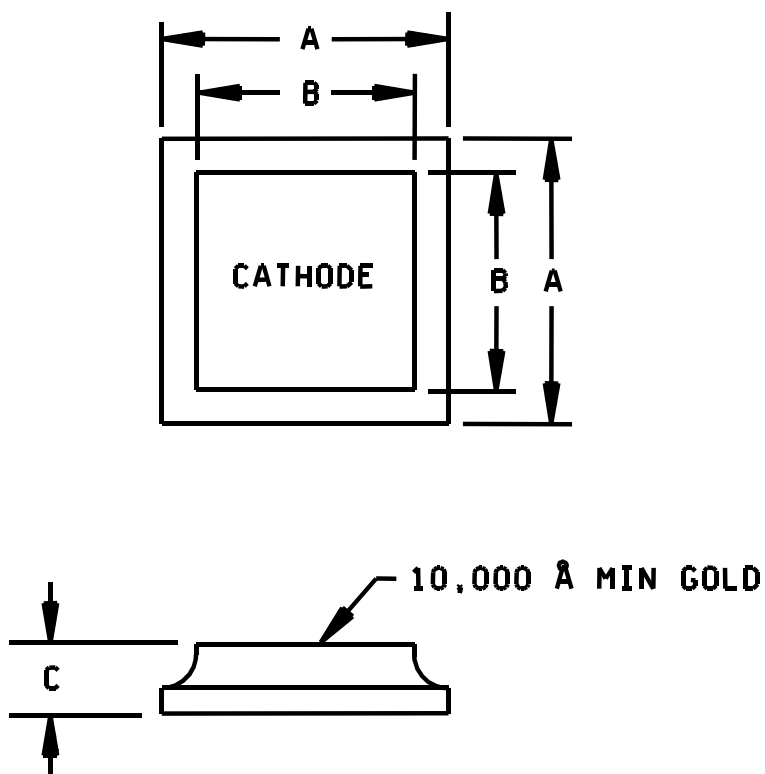

Ltr	Dimensions			
	Inches		Millimeters	
	Min	Max	Min	Max
A	.060	.065	1.52	1.65
B	.052	.058	1.32	1.47
C	.008	.014	0.20	0.36

**NOTES:**

1. Dimensions are in inches.
2. Millimeters are given for general information only.
3. The physical characteristics are  
 Top (cathode) Au Thickness = 10,000Å minimum,  
 Back (anode) Au Thickness = 4,000Å minimum.
4. In accordance with ASME Y14.5M, diameters are equivalent to  $\phi$ x symbology.

FIGURE 5. JANHCC (C-version) die dimensions.

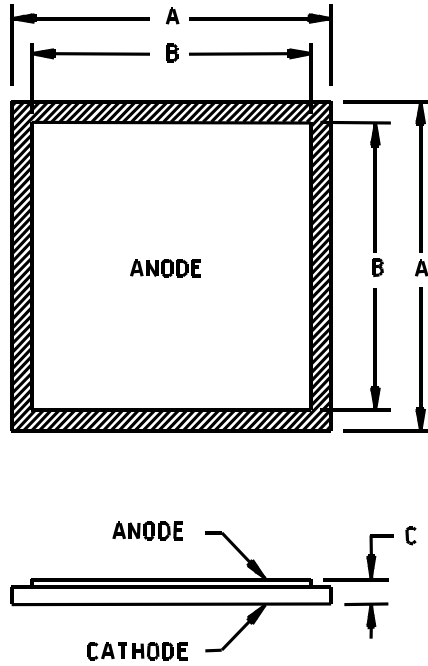

Ltr	Inches		Millimeters	
	Min	Max	Min	Max
A	.081	.087	2.05	2.20
B	.055	.061	1.40	1.55
C	.007	.012	0.18	0.30

NOTES:

1. Dimensions are in inches.
2. Millimeters are given for general information only.
3. The physical characteristics are
  - Top (anode) Al Thickness = 60,000Å minimum.
  - Back (cathode) Au Thickness = 2,500Å minimum,
4. In accordance with ASME Y14.5M, diameters are equivalent to  $\phi$ x symbology.

FIGURE 6. JANHCD and JANKCD (D-version) die dimensions.



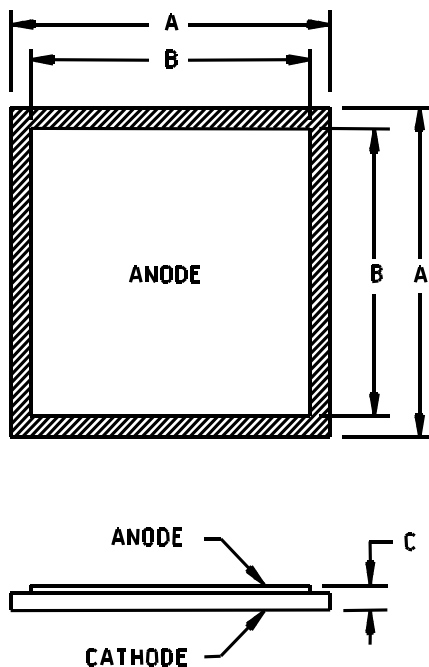

Ltr	Inches		Millimeters	
	Min	Max	Min	Max
A	.081	.087	2.05	2.20
B	.055	.061	1.40	1.55
C	.007	.012	0.18	0.30

NOTES:

1. Dimensions are in inches.
2. Millimeters are given for general information only.
3. The physical characteristics are
  - Top (anode) Al Thickness = 60,000Å minimum.
  - Back (cathode) Al/Ti/Ni/Ag Thickness = 2,500Å minimum,
4. In accordance with ASME Y14.5M, diameters are equivalent to  $\phi$ x symbology.

FIGURE 7. JANHCE and JANKCE (E-version) die dimensions.

## 2. APPLICABLE DOCUMENTS

2.1 General. The documents listed in this section are specified in sections 3, 4, or 5 of this specification. This section does not include documents cited in other sections of this specification or recommended for additional information or as examples. While every effort has been made to ensure the completeness of this list, document users are cautioned that they must meet all specified requirements of documents cited in sections 3, 4, or 5 of this specification, whether or not they are listed.

### 2.2 Government documents.

2.2.1 Specifications, standards, and handbooks. The following specifications, standards, and handbooks form a part of this document to the extent specified herein. Unless otherwise specified, the issues of these documents are those cited in the solicitation or contract.

#### DEPARTMENT OF DEFENSE SPECIFICATIONS

[MIL-PRF-19500](#) - Semiconductor Devices, General Specification for.

#### DEPARTMENT OF DEFENSE STANDARDS

[MIL-STD-750](#) - Test Methods for Semiconductor Devices.

\* (Copies of these documents are available online at <http://quicksearch.dla.mil/> or <https://assist.dla.mil/> or from the Standardization Document Order Desk, 700 Robbins Avenue, Building 4D, Philadelphia, PA 19111-5094.)

2.3 Order of precedence. Unless otherwise noted herein or in the contract, in the event of a conflict between the text of this document and the references cited herein, the text of this document takes precedence. Nothing in this document, however, supersedes applicable laws and regulations unless a specific exemption has been obtained.

## 3. REQUIREMENTS

3.1 General. The individual item requirements shall be as specified in [MIL-PRF-19500](#) and as modified herein.

3.2 Qualification. Devices furnished under this specification shall be products that are manufactured by a manufacturer authorized by the qualifying activity for listing on the applicable qualified manufacturer's list (QML) before contract award (see [4.2](#) and [6.3](#)).

3.3 Abbreviations, symbols, and definitions. Abbreviations, symbols, and definitions used herein shall be as specified in [MIL-PRF-19500](#) and as follows.

EC ..... End-cap.

3.4 Interface and physical dimensions. The interface and physical dimensions shall be as specified in [MIL-PRF-19500](#) and on [figure 1](#) for 1N5550 through 1N5554, [figure 2](#) for 1N5550US through 1N5554US, and [figures 3, 4, 5, 6, and 7](#) (JANHC and JANKC).

3.4.1 Lead finish. Unless otherwise specified, lead or end cap finish shall be solderable in accordance with [MIL-PRF-19500](#), [MIL-STD-750](#), and herein. When solder alloy is used for finish the maximum lead temperature is limited to 175°C maximum. Where a choice of finish is desired, it shall be specified in the acquisition document (see [6.2](#)).

3.4.2 Diode construction. These devices shall be constructed utilizing non-cavity double plug construction with high temperature metallurgical bonding between both sides of the silicon die and terminal pins. Metallurgical bond shall be in accordance with the requirements of category I appendix A, [MIL-PRF-19500](#). No point contacts. Silver button dumet design is prohibited. US version devices shall be structurally identical to the non-surface mount devices except for lead terminations.

3.5 Marking. Marking shall be in accordance with [MIL-PRF-19500](#).

3.5.1 Marking of US version. For US version only, all marking may be omitted from the device except for the cathode marking. All marking which is omitted from the body of the device shall appear on the label of the initial container.

3.5.2 Polarity. The polarity shall be indicated with a contrasting color band to denote the cathode end. Alternately for surface mount (US) devices, a minimum of three evenly spaced contrasting color dots around the periphery of the cathode end may be used. No color coding will be permitted.

3.6 Electrical performance characteristics. Unless otherwise specified herein, the electrical performance characteristics are as specified in [1.3](#), [1.4](#), and [table I](#) herein.

3.7 Electrical test requirements. The electrical test requirements shall be the subgroups specified in [table I](#) herein.

3.8 Workmanship. Semiconductor devices shall be processed in such a manner as to be uniform in quality and shall be free from other defects that will affect life, serviceability, or appearance.

#### 4. VERIFICATION

4.1 Classification of inspections. The inspection requirements specified herein are classified as follows:

- a. Qualification inspection (see [4.2](#)).
- b. Screening (see [4.3](#)).
- c. Conformance inspection (see [4.4](#)).

4.2 Qualification inspection. Qualification inspection shall be in accordance with [MIL-PRF-19500](#) and as specified herein.

4.2.1 Group E inspection. Group E inspection shall be performed for qualification or requalification only. In case qualification was awarded to a prior revision of the specification sheet that did not request the performance of [table II](#) tests, the tests specified in [table II](#) herein that were not performed in the prior revision shall be performed on the first inspection lot to this revision to maintain qualification.

4.2.2 JANHC and JANKC die. Qualification shall be in accordance with appendix G of [MIL-PRF-19500](#) and as specified herein.

\* 4.3 Screening (JANS, JANTXV, and JANTX levels only). Screening shall be in accordance with appendix E, table E-IV of MIL-PRF-19500, and as specified herein. Specified electrical measurements shall be made in accordance with table I herein. Devices that exceed the limits of table I herein shall not be acceptable.

Screen (see Appendix E, table E-IV of MIL-PRF-19500)	JANS level	JANTXV and JANTX level
(1) 3c	Thermal impedance (see 4.3.1 and 4.4.1)	Thermal impedance (see 4.3.1 and 4.4.1)
9	$V_{F1}$ and $I_{R1}$	Not applicable
10	Method 1038 of MIL-STD-750, condition A	Method 1038 of MIL-STD-750, condition A
* (2) 11	$V_{F1}$ and $I_{R1}$ ; $\Delta V_{F1} \leq \pm 0.1$ V dc $\Delta I_{R1} \pm 250$ nA dc or 100 percent of initial value whichever is greater.	$V_{F1}$ and $I_{R1}$
12	Required, see 4.3.2	Required, see 4.3.2
* (2) (3) 13	Subgroups 2 and 3 of table I herein; $\Delta I_{R1} \leq 100$ percent of initial reading or 250 nA dc, whichever is greater. $\Delta V_{F1} \leq \pm 1$ V dc change from initial value. Scope display evaluation (see 4.5.3)	Subgroup 2 of table I herein; $\Delta I_{R1} \leq 100$ percent of initial reading or 250 nA dc, whichever is greater. $\Delta V_{F1} \leq \pm 1$ V dc change from initial value. Scope display evaluation (see 4.5.3)

(1) Thermal impedance shall be performed any time after sealing provided temperature cycling is performed in accordance with MIL-PRF-19500, screen 3 prior to this thermal test.

\* (2) For JANTX and JANTXV devices,  $\Delta V_{F1}$  may be omitted if thermal impedance is performed, unless irradiation is used to reduce the carrier lifetime.

(3)  $Z_{0JX}$  is not required in screen 13, if already previously performed.

4.3.1 Thermal impedance. The thermal impedance measurements shall be performed in accordance with method 3101 of MIL-STD-750 using the guidelines in that method for determining  $I_M$ ,  $I_H$ ,  $T_H$ , and K factor where appropriate). Measurement delay time ( $t_{MD}$ ) = 70  $\mu$ s max. The limit will be statistically derived. See appendix E, table E-IX subgroup 4, of MIL-PRF-19500, and table II, subgroup 4 herein.

4.3.2 Free air power burn-in conditions. Power burn-in conditions are as follows (see 4.5.2 and 4.5.2.1):  $I_O = 3A$  minimum;  $T_A = 55^\circ C$  maximum. Test conditions in accordance with method 1038 of MIL-STD-750, condition B. Use method 3100 of MIL-STD-750 to measure  $T_J$ . Adjust  $I_O$  or  $T_A$  to achieve the required  $T_J$ .  $T_J = 135^\circ C$  minimum. With approval of the qualifying activity and preparing activity, alternate burn-in criteria (hours, bias conditions,  $T_J$ , mounting conditions) may be used for JANTX and JANTXV quality levels. A justification demonstrating equivalence is required. In addition, the manufacturing site's burn-in data and performance history will be essential criteria for burn-in modification approval.

4.3.3 Screening (JANHC and JANKC). Screening of die shall be in accordance with appendix G of MIL-PRF-19500. As a minimum, die shall be 100-percent probed to ensure compliance with table I, subgroup 2. Burn-in duration for the JANKC level follows JANS requirements; the JANHC follows JANTX requirements.

4.4 Conformance inspection. Conformance inspection shall be in accordance with MIL-PRF-19500 and as specified herein.

4.4.1 Group A inspection. Group A inspection shall be conducted in accordance with MIL-PRF-19500 and table I herein.  $Z_{0JX}$  endpoint shall be derived by the supplier and approved by the qualifying activity. This  $Z_{0JX}$  end-point shall be documented in the qualification report.

MIL-PRF-19500/420M

\* 4.4.2 Group B inspection. Group B inspection shall be conducted in accordance with the tests and conditions specified for subgroup testing in table E-VIA (JANS) and table E-VIB (JAN, JANTX, and JANTXV) of [MIL-PRF-19500](#). Electrical measurements (end-points) requirements shall be in accordance with [table I](#), subgroup 2 herein. Delta measurements shall be as specified in [table III](#) herein.

4.4.2.1 Group B inspection, table E-VIA (JANS) of [MIL-PRF-19500](#). For B5, if a failure occurs, resubmission shall be at the test conditions of the original sample.

<u>Subgroup</u>	<u>Method</u>	<u>Condition</u>
B3	4066	$I_{FSM} = \text{rated } I_{FSM}$ (see col. 6 of <a href="#">1.3.2</a> ); ten surges of 8.3 ms each at 1 minute intervals, superimposed on $I_O = 2A$ , $V_{RWM} = \text{Rated}$ . $T_A = +55^\circ\text{C}$ max.
B4	1037	$I_O = 2.4$ A minimum. $V_R = \text{rated } V_{RWM}$ (see col. 2 of <a href="#">1.3.2</a> ); 2,000 cycles. $T_A = 55^\circ\text{C}$ max
* B5	1027	$I_O = 3$ A minimum (see col. 4 of <a href="#">1.3.2</a> ), apply $V_R = \text{rated } V_{RWM}$ (see col. 2 of <a href="#">1.3.2</a> , <a href="#">4.5.2</a> , and <a href="#">4.5.2.1</a> ) adjust $I_O$ to achieve $T_J$ minimum; $f = 50\text{-}60$ Hz. $T_A = +55^\circ\text{C}$ max. $T_J = 175^\circ\text{C}$ minimum; $t = 1,000$ hours. $n = 45$ , $c = 0$ . For irradiated devices, include $t_{rr}$ as an end-point measurement.
B8	4065	Peak reverse power $P_{RM} \geq 636$ W for square wave in accordance with test method 4065 of <a href="#">MIL-STD-750</a> ( $P_{RM} \geq 1,000$ W for half-sine wave). Test shall be performed on each subplot; sampling plan. $n = 10$ , $c = 0$ , electrical end-points, see <a href="#">table I</a> , subgroup 2 herein.

4.4.2.2 Group B inspection, table E-VIB (JAN, JANTX and JANTXV of [MIL-PRF-19500](#)).

<u>Subgroup</u>	<u>Method</u>	<u>Condition</u>
* B3	1027	$I_O = 3$ A minimum, adjust $I_O$ or $T_A$ to achieve the required $T_J$ apply $V_R = \text{rated } V_{RWM}$ (see col. 2 of <a href="#">1.3</a> ), $T_A = +55^\circ\text{C}$ max. $f = 50\text{-}60$ Hz (see <a href="#">4.5.2</a> and <a href="#">4.5.2.1</a> ). $T_J = 150^\circ\text{C}$ minimum. For irradiated devices, include $t_{rr}$ as an end-point measurement.

\* 4.4.3 Group C inspection. Group C inspection shall be conducted in accordance with the tests and conditions specified for subgroup testing in table VII of [MIL-PRF-19500](#). Electrical measurements (end-points) requirements shall be in accordance with [table I](#), subgroup 2 herein. Delta measurements shall be as specified in [table III](#) herein.

\* 4.4.3.1 Group C inspection, table VII of MIL-PRF-19500.

<u>Subgroup</u>	<u>Method</u>	<u>Condition</u>
C2	2036	Axial devices – Tension: Test condition A; weight = 20 pounds; t = 15 seconds. Lead fatigue: Test condition E; weight 2 pounds. (Lead fatigue is not applicable to US diodes).
C2	2036	US devices – Tension: Test condition A; weight = 20 pounds; t = 15 seconds. Suitable fixtures may be used to pull the end-caps in a manner which does not aid construction. Reference to axial lead may be interpreted as end-cap with fixtures used for mounting (see <a href="#">figure 10</a> herein). (Lead fatigue is not applicable to US diodes).
C5	4081	$R_{\theta JL}(\text{maximum}) \leq 22^{\circ}\text{C/W}$ , $L = .375$ inch (9.53 mm). For surface mount devices (US version), $R_{\theta JEC} \leq 6.5^{\circ}\text{C/W}$ (see <a href="#">4.5.4</a> ).
* C6	1026	$T_J = 150^{\circ}\text{C}$ minimum (see <a href="#">4.5.2</a> and <a href="#">4.5.2.1</a> ). $I_O = 3$ amps minimum adjust $I_O$ to achieve the required $T_J$ ; apply $V_R = \text{rated } V_{RWM}$ (see col. 2 of <a href="#">1.3.2</a> ), $T_A = +55^{\circ}\text{C}$ max. $f = 50\text{-}60$ Hz (see <a href="#">4.5.2.1</a> ). For irradiated devices, include $t_{rr}$ as an end-point measurement.

\* 4.4.4 Group E inspection. Group E inspection shall be conducted in accordance with the conditions specified for subgroup testing in appendix E, table E-IX of [MIL-PRF-19500](#) and as specified herein. Electrical measurements (end-points) requirements shall be in accordance with [table I](#), subgroup 2 herein and delta requirements of [table III](#) herein.

4.5 Methods of inspection. Methods of inspection shall be as specified in appropriate tables and as follows.

4.5.1 Pulse measurements. Conditions for pulse measurement shall be as specified in section 4 of [MIL-STD-750](#).

4.5.2 Burn-in and life tests. These tests shall be conducted with a half-sine waveform of the specified peak voltage impressed across the diode in the reverse direction followed by a half-sine waveform of the specified average rectified current. The forward conduction angle of the rectified current shall be neither greater than 180 degrees, nor less than 150 degrees.

4.5.2.1 Burn-in and life tests The use of a current limiting or ballast resistor is permitted provided that each DUT still sees the required  $T_J$  and full rated  $I_O$  and that the minimum required voltage  $V_{RWM}$  is maintained throughout the burn-in period. Use method 3100 of [MIL-STD-750](#) to measure  $T_J$ . With the approval of the qualifying activity, the supplier may apply  $T_J = 200^{\circ}\text{C}$  max during burn-in test.

4.5.3 Scope display evaluation. Scope display evaluation shall be sharp and stable in accordance with method 4023 of [MIL-STD-750](#). Scope display may be performed on ATE (automatic test equipment) for screening only, with the approval of the qualifying activity. Scope display in [table I](#), subgroup 4 shall be performed on a curve tracer. The reverse current ( $I_{BR}$ ) over the knee shall be 500  $\mu\text{A}$  peak.

4.5.4 Thermal resistance. Thermal resistance measurement shall be performed in accordance with method 4081 of [MIL-STD-750](#) using the guidelines in that method for determining  $I_M$ ,  $I_H$ , and  $t_H$ . Measurement delay time  $t_{MD} = 70 \mu\text{s}$  max. See appendix E, table E-IX, subgroup 4 of [MIL-PRF-19500](#), and figures 8, and 9 herein.

MIL-PRF-19500/420M

\* TABLE I. Group A inspection.

Inspection <u>1/</u>	MIL-STD-750		Symbol	Limits		Unit
	Method	Conditions		Min	Max	
<u>Subgroup 1</u>						
Visual and mechanical inspection	2071					
<u>Subgroup 2</u>						
Thermal impedance <u>2/</u>	3101	See 4.3.1	$Z_{\theta JX}$			°C/W
Forward voltage	4011	$I_F = 9.0 \text{ A}$ ; duty cycle $\leq 2$ percent (pulsed see 4.5.1); $t_p \leq 8.3 \text{ ms}$	$V_{F1}$			
1N5550, 1N5550US				0.6	1.2	V
1N5551, 1N5551US				0.6	1.2	V
1N5552, 1N5552US				0.6	1.2	V
1N5553, 1N5553US				0.6	1.3	V
1N5554, 1N5554US				0.6	1.3	V
Forward voltage	4011	$I_F = 1.5 \text{ A}$	$V_{F2}$	0.5	1.0	V
Reverse current leakage	4016	DC method or equivalent pulse	$I_{R1}$			
1N5550, 1N5550US		$V_R = 200 \text{ V}$			1.0	$\mu\text{A}$
1N5551, 1N5551US		$V_R = 400 \text{ V}$			1.0	$\mu\text{A}$
1N5552, 1N5552US		$V_R = 600 \text{ V}$			1.0	$\mu\text{A}$
1N5553, 1N5553US		$V_R = 800 \text{ V}$			1.0	$\mu\text{A}$
1N5554, 1N5554US		$V_R = 1,000 \text{ V}$			1.0	$\mu\text{A}$
Breakdown voltage (diodes)	4021		$V_{BR1}$			
1N5550, 1N5550US		$I_R = 50 \mu\text{A}$		220		V
1N5551, 1N5551US		$I_R = 50 \mu\text{A}$		440		V
1N5552, 1N5552US		$I_R = 50 \mu\text{A}$		660		V
1N5553, 1N5553US		$I_R = 50 \mu\text{A}$		880		V
1N5554, 1N5554US		$I_R = 50 \mu\text{A}$		1,100		V

See footnote at end of table.

\* TABLE I. Group A inspection - Continued.

Inspection <u>1/</u>	MIL-STD-750		Symbol	Limits		Unit
	Method	Conditions		Min	Max	
<u>Subgroup 3</u>						
High temperature operation:		$T_A = +125^\circ\text{C}$				
Reverse current leakage	4016	DC method or equivalent pulse	$I_{R2}$			
1N5550, 1N5550US		$V_R = 200\text{ V}$			60	$\mu\text{A}$
1N5551, 1N5551US		$V_R = 400\text{ V}$			60	$\mu\text{A}$
1N5552, 1N5552US		$V_R = 600\text{ V}$			60	$\mu\text{A}$
1N5553, 1N5553US		$V_R = 800\text{ V}$			60	$\mu\text{A}$
1N5554, 1N5554US		$V_R = 1,000\text{ V}$			60	$\mu\text{A}$
Forward voltage	4011	$I_F = 9.0\text{ A}$ ; duty cycle $\leq 2$ percent (pulsed see 4.5.1); $t_p \leq 8.3\text{ ms}$	$V_{F2}$			
1N5550, 1N5550US					1.2	V
1N5551, 1N5551US					1.2	V
1N5552, 1N5552US					1.2	V
1N5553, 1N5553US					1.3	V
1N5554, 1N5554US					1.3	V
Low temperature operation:		$T_A = -55^\circ\text{C}$				
Forward voltage	4011	$I_F = 9.0\text{ A}$ ; duty cycle $\leq 2$ percent (pulsed); $t_p \leq 8.3\text{ ms}$	$V_{F3}$		1.5	V
Forward voltage	4011	$I_F = 1.5\text{ A}$	$V_{F4}$	0.5	1.2	V
Breakdown voltage (diodes)	4021		$V_{BR2}$			
1N5550, 1N5550US		$I_R = 50\ \mu\text{A}$		200		V
1N5551, 1N5551US		$I_R = 50\ \mu\text{A}$		400		V
1N5552, 1N5552US		$I_R = 50\ \mu\text{A}$		600		V
1N5553, 1N5553US		$I_R = 50\ \mu\text{A}$		800		V
1N5554, 1N5554US		$I_R = 50\ \mu\text{A}$		1,000		V
<u>Subgroup 4</u>						
Reverse recovery time	4031	Condition B1	$t_{rr}$		2.0	$\mu\text{s}$
Scope display evaluation	4023	See 4.5.3, $n = 116$ , $c = 0$				

See footnote at end of table.



\* TABLE I. Group A inspection - Continued.

Inspection <u>1/</u>	MIL-STD-750		Symbol	Limits		Unit
	Method	Conditions		Min	Max	
<u>Subgroups 5</u> Not applicable						
<u>Subgroup 6</u> Forward surge	4066	I <sub>FSM</sub> = rated (see col. 6 of <a href="#">1.3.2</a> ); ten surges of 8.3 ms each at 1 minute intervals, superimposed on I <sub>O</sub> = 2 A, V <sub>RSM</sub> = rated V <sub>RWM</sub> See column 2 of <a href="#">1.3</a> T <sub>A</sub> = +55°C				
Electrical measurement		See <a href="#">table I</a> , subgroup 2.				
<u>Subgroup 7</u> Not applicable						

1/ For sampling plan, see [MIL-PRF-19500](#).

\* 2/ This test required for the following end-point measurements only:  
 Group B, subgroups 3, 4, and 5 (JANS).  
 Group B, subgroups 2 and 3 (JAN, JANTX, and JANTXV).  
 Group C, subgroup 2 and 6.  
 Group E, subgroup 1.

\* TABLE II. Group E inspection (all quality levels) for qualification and requalification only.

Inspection	MIL-STD-750		Sampling plan
	Method	Conditions	
<u>Subgroup 1A</u>			
Temperature cycling (air to air)	1051	20 cycles, except high temperature shall be 150 C and low temperature shall be -195°C.	45 devices c = 0
Hermetic seal	1071		
Electrical measurement		See <a href="#">table I</a> , subgroup 2 and <a href="#">table III</a> herein.	
<u>Subgroup 1B</u>			
Temperature cycling (air to air)	1051	-65°C to +175°C, 500 cycles.	45 devices c = 0
Hermetic seal	1071		
Electrical measurement		See <a href="#">table I</a> , subgroup 2 and <a href="#">table III</a> herein.	
<u>Subgroup 2</u>			
* Steady state dc blocking life	1048	1,000 hours, $V_R = V_{RWM}$ (see col. 2 of <a href="#">1.3</a> ).	22 devices c = 0
* Electrical measurements		See <a href="#">table I</a> , subgroup 2 (except $Z_{0JX}$ need not be performed) and <a href="#">table III</a> herein. For irradiated devices, include $t_{rr}$ as an end-point measurement.	
<u>Subgroup 4</u>			
Thermal impedance curves		See <a href="#">MIL-PRF-19500</a> .	
<u>Subgroup 5</u>			
Barometric pressure, reduced (altitude operation)	1001	Pressure (see <a href="#">1.3.2</a> ); $t = 1$ min. DC method; $V_R = V_{RWM}$ (see <a href="#">1.3.2</a> ); $I_{R1} = 1.0 \mu A$ dc maximum.	22 devices c = 0

\* TABLE II. Group E inspection (all quality levels) for qualification and requalification only - Continued.

Inspection	MIL-STD-750		Sampling plan
	Method	Conditions	
<u>Subgroup 8</u> Peak reverse power  Electrical measurement	4065	Peak reverse power ( $P_{RM}$ ) shall be characterized by the supplier and this data shall be available to the Government. Test shall be performed on each subplot.  During the $P_{RM}$ test, the voltage ( $V_{BR}$ ) shall be monitored to verify it has not collapsed. Any collapse in $V_{BR}$ during or after the $P_{RM}$ test or rise in leakage current ( $I_R$ ) after the test that exceeds $I_{R1}$ in <a href="#">table I</a> shall be considered a failure to that level of applied $P_{RM}$ . Progressively higher levels of $P_{RM}$ shall be applied until failure occurs on all devices within the chosen sample size to characterize each subplot.	n=45
<u>Subgroup 9</u> Resistance to glass cracking	1057	Step stress to destruction by increasing cycles or up to a maximum of 25 cycles.	n = 45
<u>Subgroup 10</u> Forward surge  Electrical measurement	4066	$I_{FSM} = 100 \text{ A(pk)}$ ; ten surges of 8.3 ms each at 1 minute intervals, superimposed on $I_O = 2 \text{ A dc}$ ; $V_{RWM} = \text{rated } V_{RWM}$ (see column. 2 of <a href="#">1.3.2</a> ). $T_A = +55^\circ\text{C}$ .  See <a href="#">table I</a> , subgroup 2 and <a href="#">table III</a> herein.	22 devices c = 0

\* TABLE III. Delta requirements. 1/ 2/ 3/ 4/ 5/

Step	Inspection	MIL-STD-750		Symbol	Limits		Unit
		Method	Conditions		Min	Max	
1	Reverse leakage current change	4016	DC method	$\Delta I_{R1}$		$\pm 100$ percent of initial value or $\pm 250$ nA dc, whichever is greater.	
2	Forward voltage change	4011	$I_F = 1.5$ A dc; pulsed (see 4.5.1)	$\Delta V_{F2}$		$\pm 50$ mV dc maximum change from previous measured value.	

- 1/ Devices which exceed [table I](#), subgroup 2 (group A) limits for this test shall not be accepted.
- 2/ The delta measurements for group B inspections in table E-VIA (JANS) of [MIL-PRF-19500](#) are as follows:
- Subgroup 3, [table III](#) herein, step 1.
  - Subgroup 4, [table III](#) herein, step 1.
  - Subgroup 5, [table III](#) herein, step 1.
- 3/ The delta measurements for group B inspections in table E-VIB (JAN, JANTX, and JANTXV) of [MIL-PRF-19500](#) are as follows:
- Subgroup 3, [table III](#) herein, step 1.
  - Subgroup 6, [table III](#) herein, step 1.
- 4/ The delta measurements for group C inspections in table E-VII of [MIL-PRF-19500](#) are as follows:
- Subgroup 2, [table III](#), step 1.
  - Subgroup 6, [table III](#), step 1.
- 5/ The delta measurements for group E inspections in table E-IX of [MIL-PRF-19500](#) are as follows
- Subgroup 1, see [table III](#), steps 1 and 2.
  - Subgroup 2, see [table III](#), steps 1 and 2.
  - Subgroup 10, see [table I](#), subgroup A2, and [table III](#), step 1.

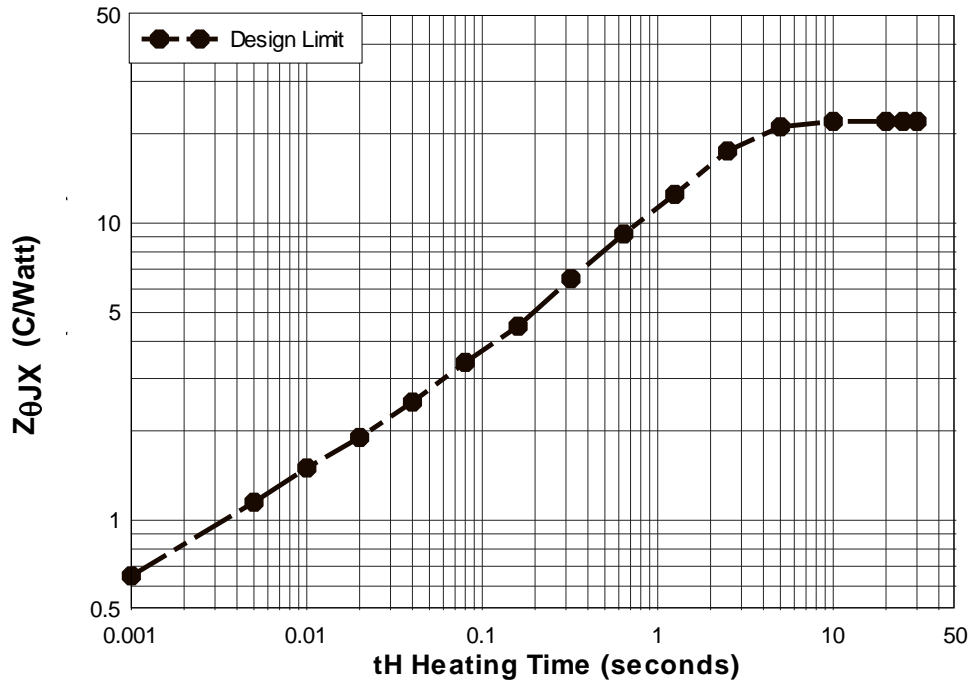

$Z_{\theta JX} = 1.5^{\circ}\text{C/W}$  at 10 ms

$R_{\theta JL} = 22^{\circ}\text{C/W}$

FIGURE 8. Axial leaded thermal-impedance curve max.

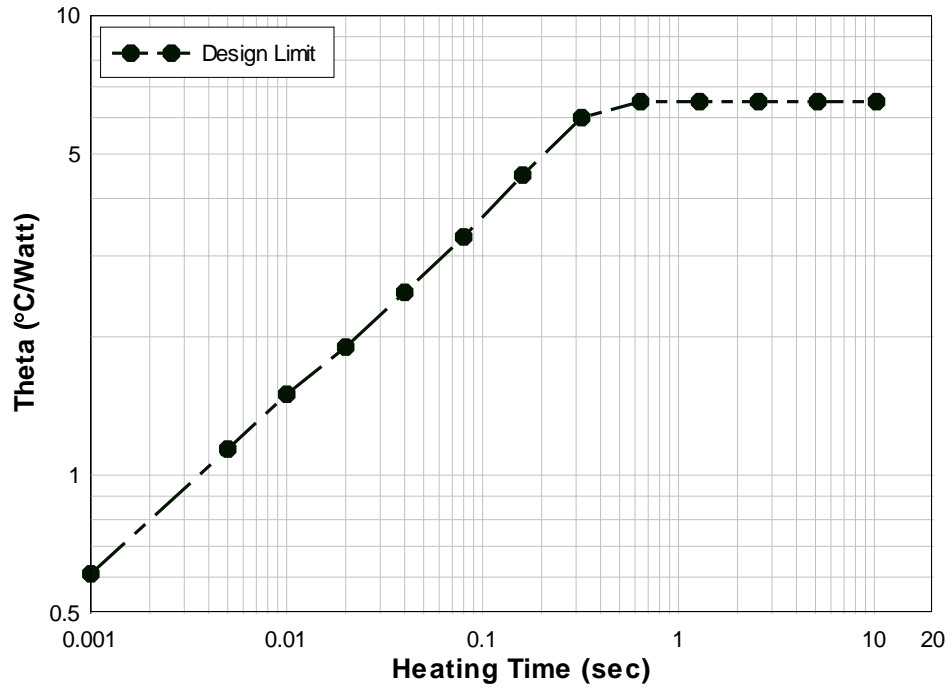

$Z_{\theta JX} = 1.5^{\circ}\text{C/W}$  at 10 ms

$R_{\theta JEC} = 6.5^{\circ}\text{C/W}$

FIGURE 9. Surface mount thermal-impedance max curve.

MIL-PRF-19500/420M

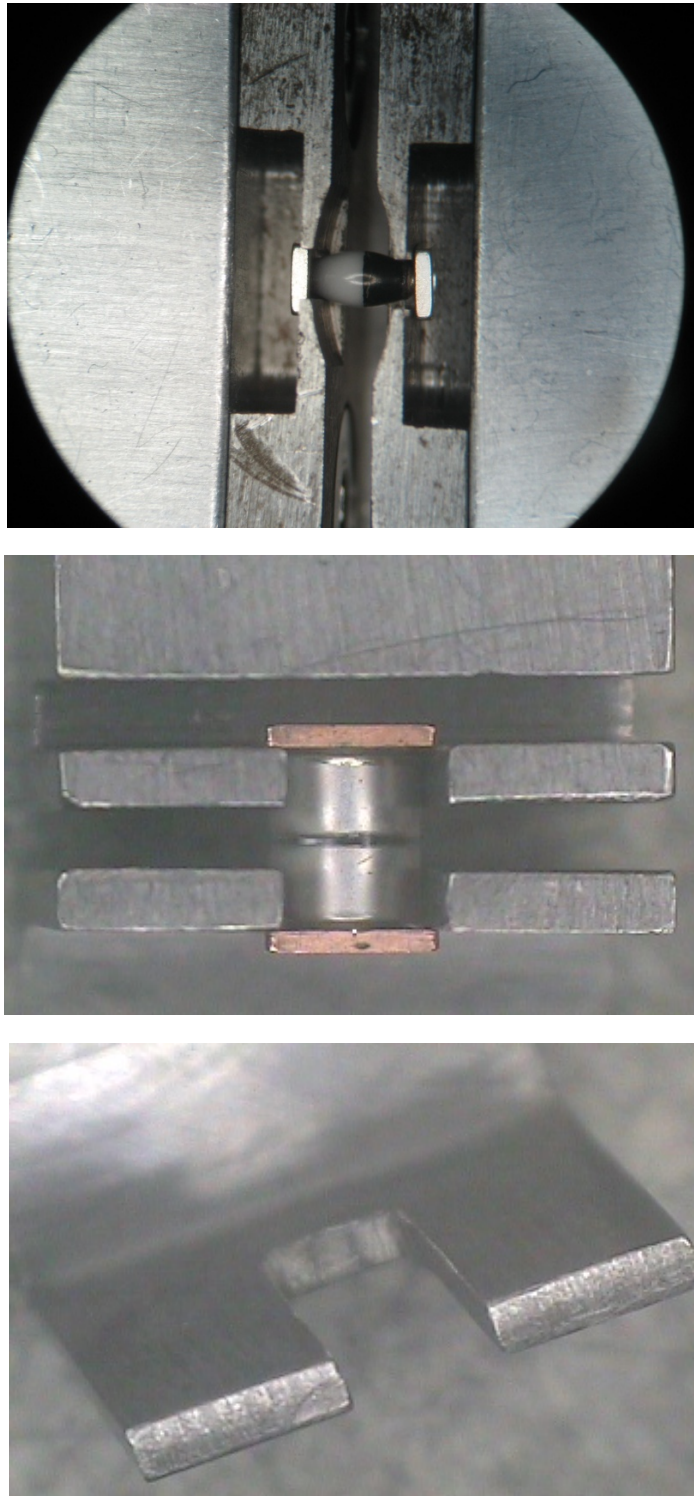

FIGURE 10. US terminal strength mounting.

## 5. PACKAGING

5.1 Packaging. For acquisition purposes, the packaging requirements shall be as specified in the contract or order (see 6.2). When packaging of materiel is to be performed by DoD or in-house contractor personnel, these personnel need to contact the responsible packaging activity to ascertain packaging requirements. Packaging requirements are maintained by the Inventory Control Point's packaging activities within the Military Service or Defense Agency, or within the Military Service's system commands. Packaging data retrieval is available from the managing Military Department's or Defense Agency's automated packaging files, CD-ROM products, or by contacting the responsible packaging activity.

## 6. NOTES

(This section contains information of a general or explanatory nature that may be helpful, but is not mandatory. The notes specified in MIL-PRF-19500 are applicable to this specification.)

6.1 Intended use. Semiconductors conforming to this specification are intended for original equipment design applications and logistic support of existing equipment.

6.2 Acquisition requirements. Acquisition documents should specify the following:

- a. Title, number, and date of this specification.
- b. Packaging requirements (see 5.1).
- c. Lead finish (see 3.4.1).
- d. Product assurance level and type designator.

\* 6.3 Qualification. With respect to products requiring qualification, awards will be made only for products which are, at the time of award of contract, qualified for inclusion in Qualified Manufacturers List (QML 19500) whether or not such products have actually been so listed by that date. The attention of the contractors is called to these requirements, and manufacturers are urged to arrange to have the products that they propose to offer to the Federal Government tested for qualification in order that they may be eligible to be awarded contracts or orders for the products covered by this specification. Information pertaining to qualification of products may be obtained from DLA Land and Maritime, ATTN: VQE, P.O. Box 3990, Columbus, OH 43218-3990 or e-mail [vqe.chief@dla.mil](mailto:vqe.chief@dla.mil). An online listing of products qualified to this specification may be found in the Qualified Products Database (QPD) at <https://assist.dla.mil>.

6.4 Supersession information. Devices covered by this specification supersede the manufacturers' and users' Part or Identifying Number (PIN). This information in no way implies that the manufacturers' PIN's are suitable as a substitute for the military PIN.

6.5 Applications data. See figure 11 for maximum power in watts as a function of lead temperature at a distance "L" from the diode body. Device current capability with lead-dissipators or body forced-air-cooling, may be determined from figure 12, which shows maximum average rectified current versus lead temperature as a function of the distance L from the diode body at which lead temperature is measured.



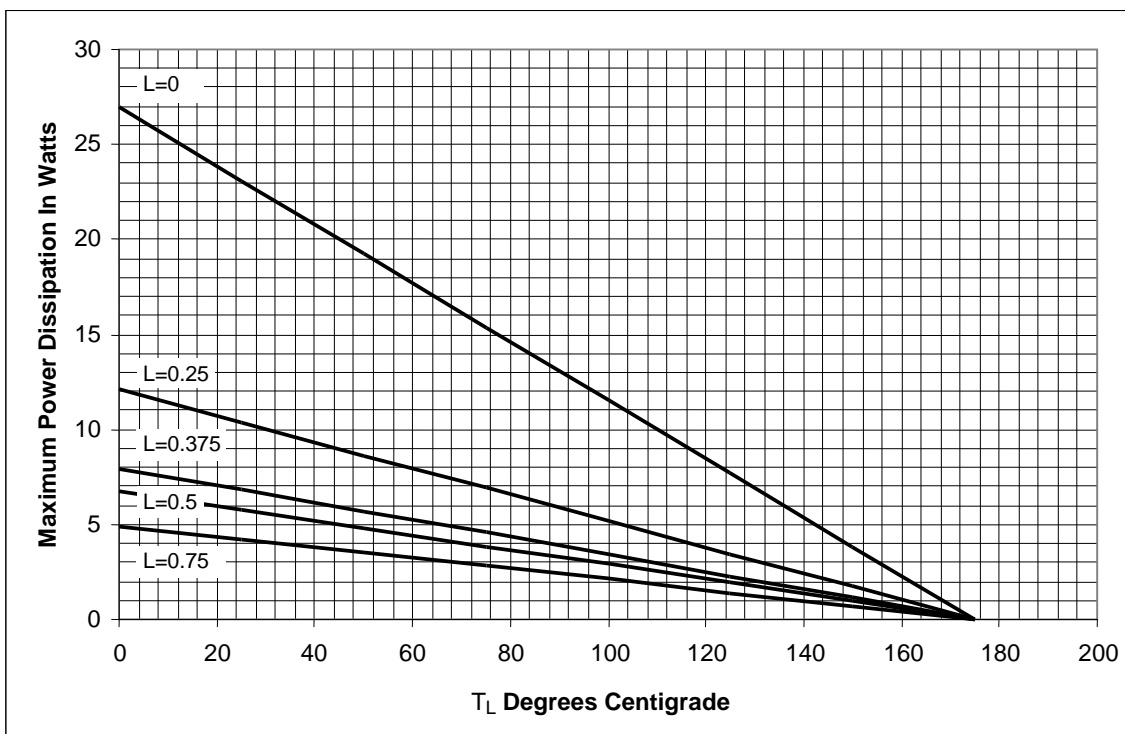

Maximum lead temperature in °C ( $T_L$ ) at point "L" from body (for maximum operating junction temperature of +175°C with equal two-lead conditions).

L		$R_{\theta JL}$
Inches	mm	°C/W
.000	0.00	6.5
.250	6.35	14.5
.375	9.53	22
.500	12.70	26
.750	19.05	35.5

NOTES:

1. Dimensions are in inches.
2. Millimeters are given for general information only.
3. In accordance with ASME Y14.5M, diameters are equivalent to  $\phi x$  symbology.

FIGURE 11. Maximum power in watts versus lead temperature.

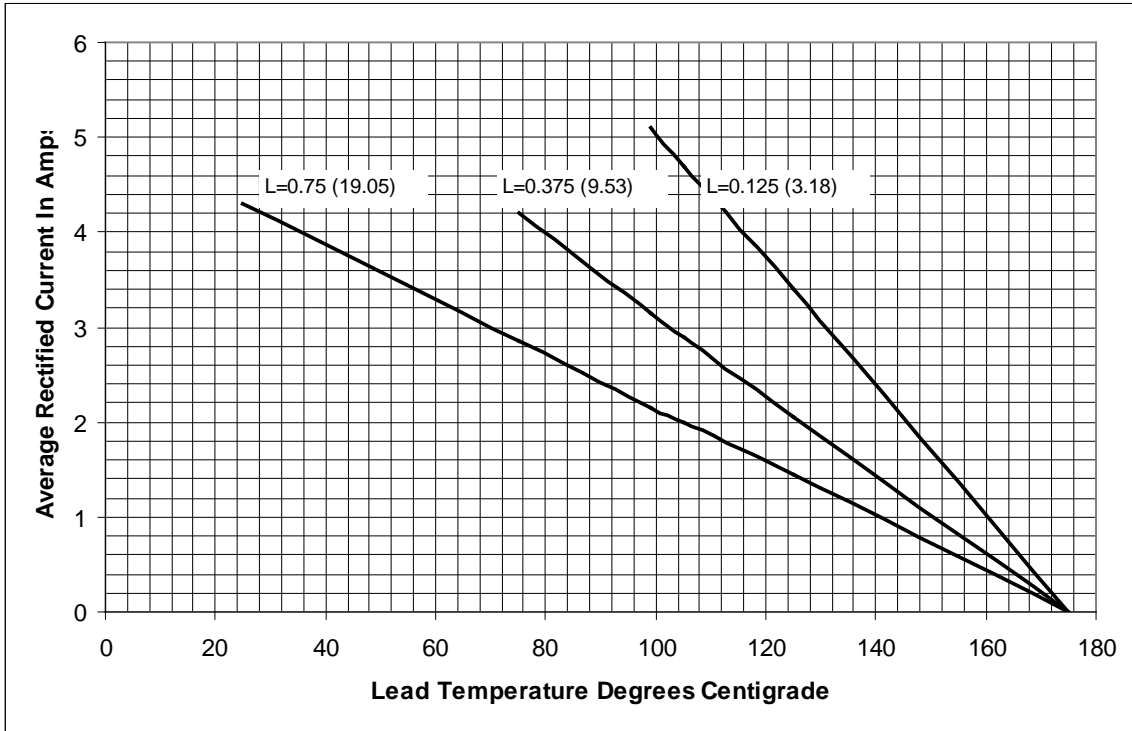

NOTES

1. Dimensions are in inches.
2. Millimeters are given for general information only.
3. In accordance with ASME Y14.5M, diameters are equivalent to  $\phi$ x symbology.

FIGURE 12. Maximum current vs lead temperature.

6.5.1 PCB mounting with FR4 material for full 3 amp I<sub>O</sub>. For a PCB mounting example with FR4 material where the full 3 amp I<sub>O</sub> rating (half-sine-wave) is used at a T<sub>J</sub> of 175°C and ambient temperature of 55°C, the following steps guide the user in what the PCB pad size will need to be with 1 oz, 2 oz, and 3 oz copper. For axial-leaded, the lead length for mounting will be .187 inch (4.76 mm) or less from body to entry point on PCB surface.

- a. Use the I<sub>O</sub> versus P<sub>o</sub> curve on [figure 13](#) to look up 3 amps (X-axis) and follow up to the T<sub>J</sub>=175°C curve (lower) for 2.55 watts.
- b. Calculate maximum thermal resistance needed  $(175^{\circ}\text{C} - 55^{\circ}\text{C}) / 2.55 \text{ W} = 47^{\circ}\text{C}/\text{W}$ .
- c. Look up thermal resistance of 47°C/W on Y-axis using a thermal resistance versus pad area plot on one of the three curves on [figure 14](#) for different weights of copper cladding and then intersect curve horizontally to get answer. These curves assume still air, horizontal position.
- \* d. In this example, the answer is: 1 oz PCB = .75 in X .75 in (19.05 mm X 19.05 mm), 2 oz PCB = .43 in x .43 in (10.92 mm X 10.92 mm), 3 oz PCB = .29 in X .29 in (7.36 mm X 7.36 mm) for each pad.
- e. Add a conservative guard-band to the pad size (larger) to keep T<sub>J</sub> below 175°C.

6.5.2 PCB mounting with FR4 material for 1 amp I<sub>O</sub>. For a PCB mounting example with FR4 material to support a 1 amp I<sub>O</sub> square wave switching at a 0.50 duty factor (50 percent duty cycle) at T<sub>J</sub> = 100°C and ambient temperature of 55°C, the following steps guide the user in what the PCB pad size will need to be with 1 oz, 2 oz, and 3 oz copper.

- a. Find size of copper pads on standard FR4 PCB to support operation at 1 amp I<sub>O</sub> square wave switching at a 0.50 duty factor (50 percent duty cycle) at T<sub>J</sub> = 100°C with T<sub>A</sub> = 55°C.
- b. Calculate peak I<sub>F</sub> = 1A / 0.50 duty factor = 2 amps.
- c. Use the V<sub>F</sub> versus I<sub>F</sub> curve on [figure 15](#) to look up I<sub>F</sub> = 2 A (Y-axis) and follow across to the T<sub>J</sub> = 100°C curve (middle) for V<sub>F</sub> = 0.81 V.
- d. Calculate power = I<sub>F</sub> x V<sub>F</sub> x duty factor = 2 x 0.81 x 0.50 = 0.81 W.
- e. Calculate maximum thermal resistance needed  $(100^{\circ}\text{C} - 55^{\circ}\text{C}) / 0.81 \text{ W} = 56^{\circ}\text{C}/\text{W}$ .
- f. Look up thermal resistance of 56°C/W on the Y-axis using a thermal resistance versus pad area plot on one of the three curves on [figure 14](#) for different weights of copper cladding and then intersect curve horizontally to get answer. Curves assume still air, horizontal position.
- \* g. In this example, the answer is: 1oz PCB = .45 in X .45 in (11.43 mm x 11.43 mm), 2oz PCB = .25 in x .25 in (6.35 mm x 6.35 mm), 3oz PCB = .17 in X .17 in (4.32 mm x 4.32 mm) for each pad.
- h. A conservative pad guard-band is optional since T<sub>J</sub> is only 100°C. NOTE: With multilayer PCBs, forced air cooling will improve performance. Closed confinement of the PCB will do the opposite. Please use sound thermal management.

Average Sine Current ( $I_o$ ) vs Total Power ( $P_o$ )

Max 1N5554 ss420, <1.3V@9A

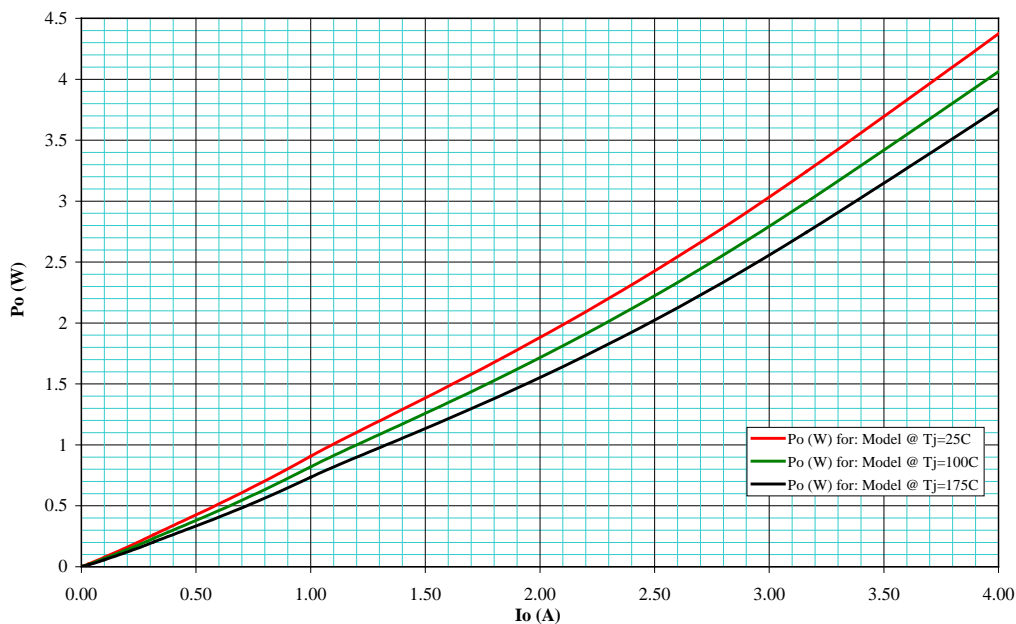

FIGURE 13. Rectifier power versus  $I_o$  (average forward current).

B-Pkg/E-Pkg MELF/Axial Thermal Resistance vs FR4 Pad Area  
Still Air, PCB Horizontal

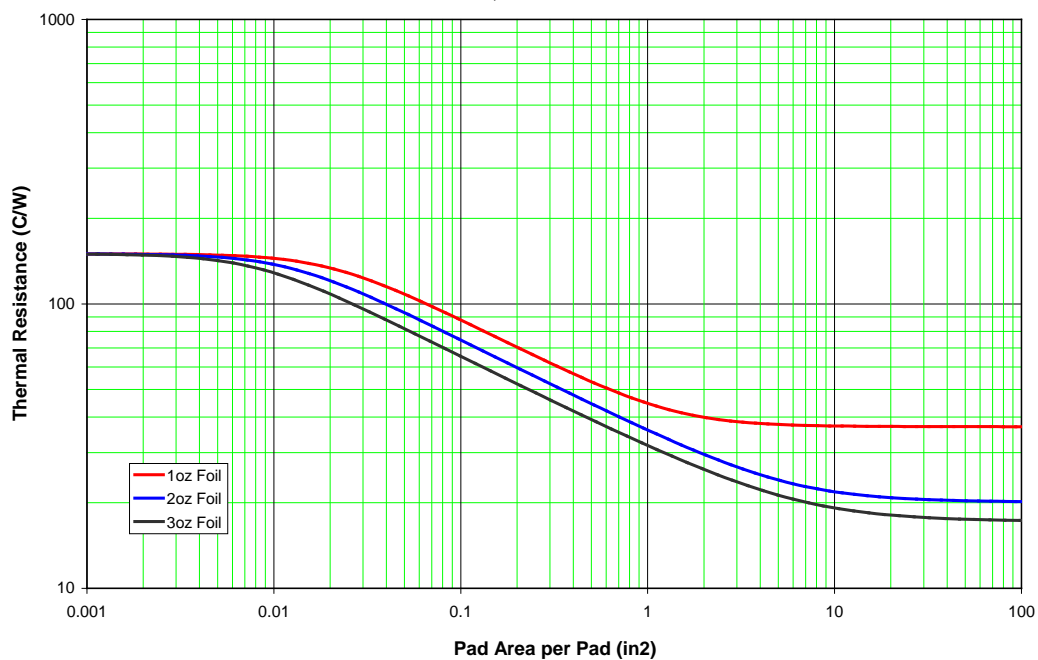

FIGURE 14. Thermal resistance versus pad area (for each pad) with 1, 2 and 3 oz copper.

**V<sub>f</sub> vs I<sub>f</sub> at Temperature**  
Max 1N5554 ss420, <1.3V@9A

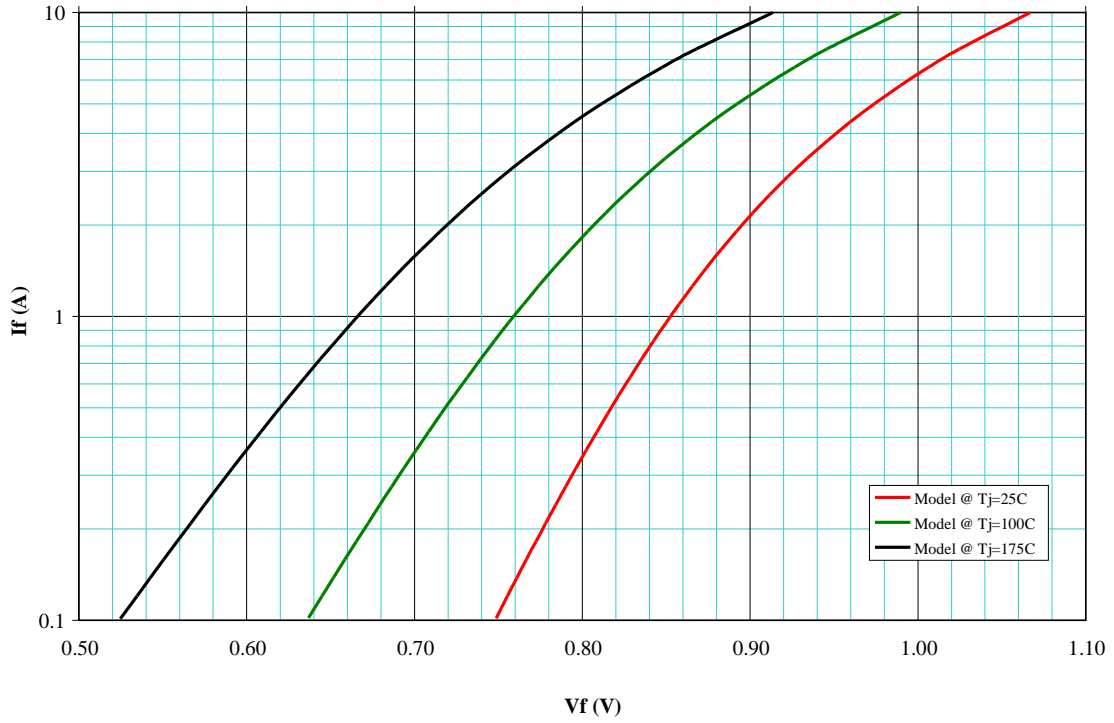

FIGURE 15. Forward voltage versus forward current for 1N5554.