

The documentation and process conversion measures necessary to comply with this document shall be completed by 24 September 2013.

INCH-POUND
MIL-PRF-19500/578M
24 June 2013
SUPERSEDING
MIL-PRF-19500/578L
19 October 2010

PERFORMANCE SPECIFICATION SHEET

SEMICONDUCTOR DEVICE, DIODE, SILICON, SWITCHING, 1N6638, 1N6642, 1N6643, 1N6638U, 1N6642U, 1N6643U, 1N6638US, 1N6642US, 1N6643US, 1N6642UB, 1N6642UB2, 1N6642UB2R, 1N6642UBCA, 1N6642UBD, 1N6642UBCC, JAN, JANTX, JANTXV, JANS, JANHC, AND JANKC

The JANS1N4148-1 is no longer qualified and is superseded by JANS1N6642. See 6.4.

This specification is approved for use by all Departments and Agencies of the Department of Defense.

The requirements for acquiring the product described herein shall consist of this specification sheet and MIL-PRF-19500.

1. SCOPE

1.1 Scope. This specification covers the performance requirements for switching diodes. Four levels of product assurance are provided for each device type as specified in MIL-PRF-19500.

* 1.2 Physical dimensions. See figures 1 (DO-35), 2 (U, US), 3 (UB), 4 (UB2), 5, and 6.

1.3 Maximum ratings. Unless otherwise specified $T_A = +25^\circ\text{C}$.

Types	V _{BR}	V _{RRWM}	I _O (PCB) T _A =75° (1) (2)	I _{FSM} t _p = 1/120 s	R _{θJL} L = .375 inch (9.53 mm) (1) (2)	R _{θJEC} L = 0 (1)	R _{θJA} (PCB) (2)	R _{θJSP} (1) (3)	T _{STG} & T _J
	V (pk)	V (pk)	mA	A (pk)	°C/W	°C/W	°C/W	°C/W	°C
1N6638	150	125	300	2.5	150		250		-65 to +175
1N6638U, 1N6638US	150	125	300	2.5		40	250		-65 to +175
1N6642	100	75	300	2.5	150		250		-65 to +175
1N6642U, 1N6642US	100	75	300	2.5		40	250		-65 to +175
1N6642UB, 1N6642UB2, 1N6642UB2R, 1N6642UBCA, 1N6642UBD, 1N6642UBCC	100	75	300	2.5			325	100	-65 to +200
1N6643	75	50	300	2.5	150		250		-65 to +175
1N6643U, 1N6643US	75	50	300	2.5		40	250		-65 to +175

- * (1) For temperature-current derating curves, see figures 7 and 8.
- * (2) See figures 9, 10, 11, and 13 for thermal impedance curves. $T_A = +75^\circ\text{C}$ for both axial and Metal Electrode Leadless Face diodes (MELF) (U, US) on printed circuit board (PCB), PCB = FR4 - .0625 inch (1.59 mm) 1-layer 1-Oz Cu, horizontal, in still air; pads for U, US = .061 inch (1.55 mm) x .105 inch (2.67 mm); pads for axial = .092 inch (2.34 mm) diameter, strip = .030 inch (0.76 mm) x 1 inch (25.4 mm) long, lead length $L \leq .187$ inch (≤ 4.75 mm); $R_{\theta JA}$ with a defined PCB thermal resistance condition included, is measured at $I_O = 300$ mA dc.
- (3) $R_{\theta JSP}$ refers to thermal resistance from junction to the solder pads of the UB package.

Comments, suggestions, or questions on this document should be addressed to DLA Land and Maritime, ATTN: VAC, P.O. Box 3990, Columbus, OH 43218-3990, or emailed to Semiconductor@dla.mil. Since contact information can change, you may want to verify the currency of this address information using the ASSIST Online database at <https://assist.dla.mil>.

MIL-PRF-19500/578M

1.4 Primary electrical characteristics. Unless otherwise specified, primary electrical characteristics at $T_A = +25^\circ\text{C}$.

Types (1)	V_{F1} $I_F = 10 \text{ mA}$	V_{F2}	I_{R1} $V_R = 20 \text{ V}$	I_{R2} $V_R = V_{RWM}$	I_{R3} $V_R = 20 \text{ V}$ $T_A = +150^\circ\text{C}$	I_{R4} $V_R = V_{RWM}$ $T_A = +150^\circ\text{C}$	t_{fr} $I_F = 200 \text{ mA}$	t_{rr} $I_{RM} = I_F = 10 \text{ mA}$	C_{T1} $V_R = 0$
	V dc	V dc	nA dc	nA dc	$\mu\text{A dc}$	$\mu\text{A dc}$	ns	ns	pF
1N6638, 1N6638U, 1N6638US	0.8	1.1 (2)	35	500	50	100	20	4.5	2.5
1N6642, 1N6642U, 1N6642US, 1N6642UB, 1N6642UB2, 1N6642UBCA, 1N6642UB2R, 1N6642UBD, 1N6642UBCC	0.8	1.2 (3)	25	500	50	100	20	5.0	5.0
1N6643, 1N6643U, 1N6643US	0.8	1.2 (3)	50	500	75	100	20	6.0	5.0

- (1) Suffix "U" devices are structurally identical to the suffix "US" devices.
- (2) $I_F = 200 \text{ mA}$.
- (3) $I_F = 100 \text{ mA}$.

2. APPLICABLE DOCUMENTS

2.1 General. The documents listed in this section are specified in sections 3, 4, or 5 of this specification. This section does not include documents cited in other sections of this specification or recommended for additional information or as examples. While every effort has been made to ensure the completeness of this list, document users are cautioned that they must meet all specified requirements of documents cited in sections 3, 4, or 5 of this specification, whether or not they are listed.

2.2 Government documents.

2.2.1 Specifications, standards, and handbooks. The following specifications, standards, and handbooks form a part of this document to the extent specified herein. Unless otherwise specified, the issues of these documents are those cited in the solicitation or contract.

DEPARTMENT OF DEFENSE SPECIFICATIONS

MIL-PRF-19500 - Semiconductor Devices, General Specification for.

DEPARTMENT OF DEFENSE STANDARDS

MIL-STD-750 - Test Methods for Semiconductor Devices.

(Copies of these documents are available online at <http://quicksearch.dla.mil> or <https://assist.dla.mil> or from the Standardization Document Order Desk, 700 Robbins Avenue, Building 4D, Philadelphia, PA 19111-5094.)

2.3 Order of precedence. Unless otherwise noted herein or in the contract, in the event of a conflict between the text of this document and the references cited herein, the text of this document takes precedence. Nothing in this document, however, supersedes applicable laws and regulations unless a specific exemption has been obtained.

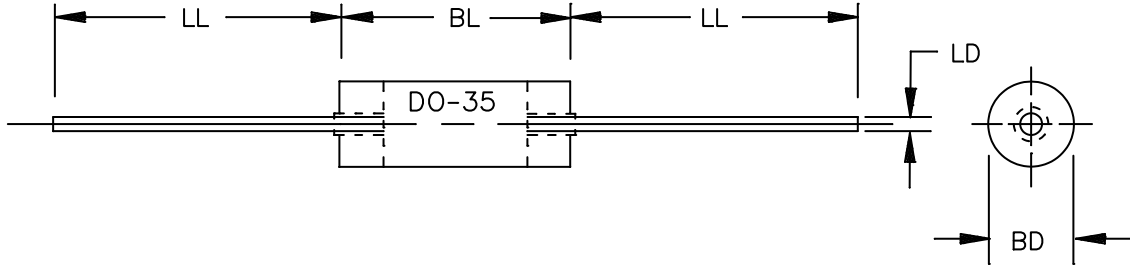

Symbol	Dimensions				Notes
	Inches		Millimeters		
	Min	Max	Min	Max	
BD	.056	.080	1.42	2.03	2
BL	.130	.180	3.30	4.57	
LD	.018	.022	0.46	0.56	3
LL	1.00	1.50	25.40	38.10	

NOTES:

1. Dimensions are in inches. Millimeters are given for general information only.
2. Dimension BD shall be measured at the largest diameter.
3. The specified lead diameter applies in the zone between .050 inch (1.27 mm) from the diode body to the end of the lead. Outside of this zone lead shall not exceed BD.
4. In accordance with ASME Y14.5M, diameters are equivalent to Φ x symbology.

TYPES 1N6638, 1N6642, AND 1N6643.

FIGURE 1. Physical dimensions (DO-35).

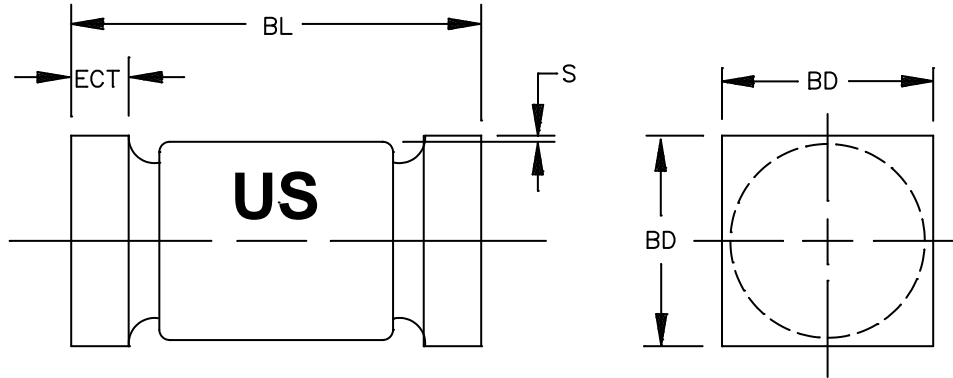

Symbol	Dimensions			
	Inches		Millimeters	
	Min	Max	Min	Max
BD	.070	.085	1.78	2.16
BL	.165	.195	4.19	4.95
ECT	.019	.028	0.48	0.71
S	.003		0.08	

NOTES:

1. Dimensions are in inches. Millimeters are given for general information only.
2. Dimensions are pre-solder dip.
3. U-suffix parts are structurally identical to the US-suffix parts.
4. In accordance with ASME Y14.5M, diameters are equivalent to Φ x symbology.

TYPES 1N6638U, 1N6642U, AND 1N6643U, 1N6638US, 1N6642US, AND 1N6643US

FIGURE 2. Physical dimensions of surface mount family.

MIL-PRF-19500/578M

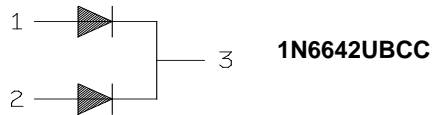
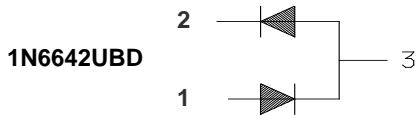
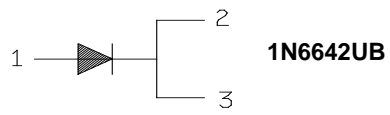
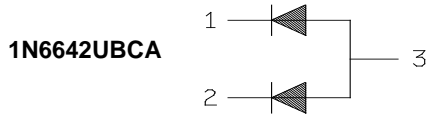
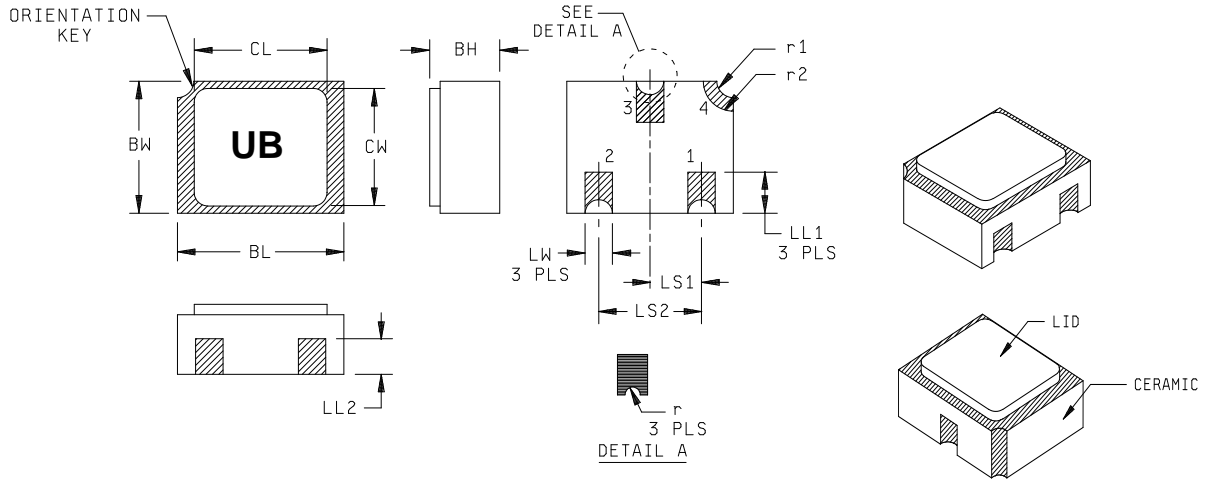

Symbol	Dimensions				Symbol	Dimensions			
	Inches		Millimeters			Inches		Millimeters	
	Min	Max	Min	Max		Min	Max	Min	Max
BH	.046	.056	1.17	1.42	LS1	.035	.039	0.89	0.99
BL	.115	.128	2.92	3.25	LS2	.071	.079	1.80	2.01
BW	.085	.108	2.16	2.74	LW	.016	.024	0.41	0.61
CL		.128		3.25	r		.008		0.20
CW		.108		2.74	r1		.012		0.31
LL1	.022	.038	0.56	0.97	r2		.022		0.56
LL2	.017	.035	0.43	0.89					

NOTES:

1. Dimensions are in inches. Millimeters are given for general information only.
2. Ceramic package only.
3. Hatched areas on package denote metallized areas. Pad 4 = shielding, connected to the lid.
4. Dimensions are pre-solder dip.
5. In accordance with ASME Y14.5M, diameters are equivalent to Φx symbology.

FIGURE 3. Physical dimensions, surface mount (UB version).

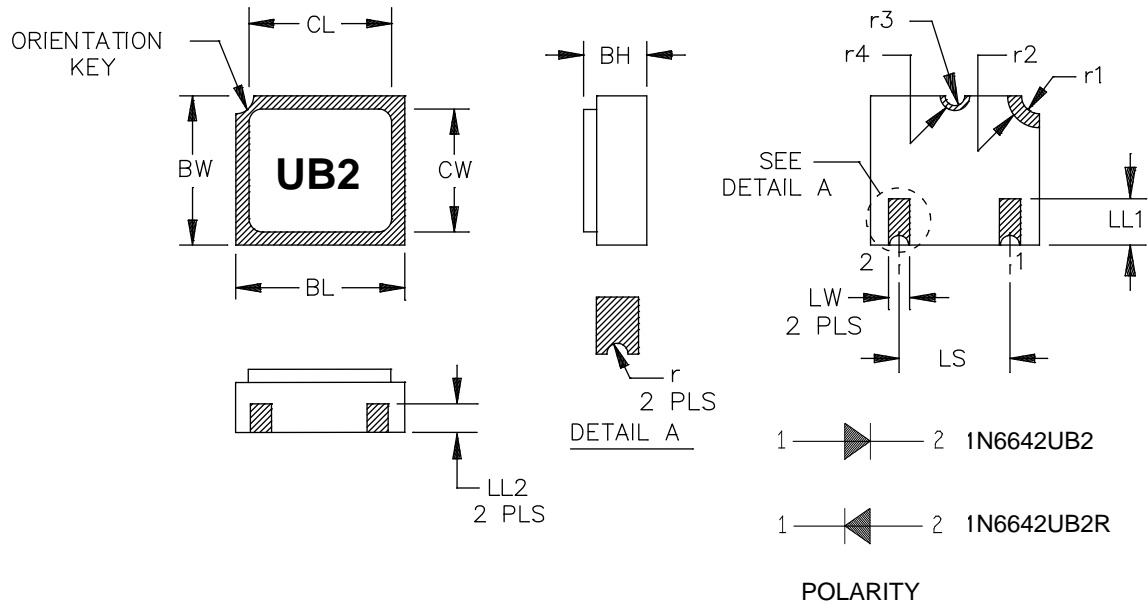

Symbol	Dimensions				Symbol	Dimensions			
	Inches		Millimeters			Inches		Millimeters	
	Min	Max	Min	Max		Min	Max	Min	Max
BH	.046	.056	1.17	1.42	LS	.071	.079	1.80	2.01
BL	.115	.128	2.92	3.25	LW	.016	.024	0.41	0.61
BW	.085	.108	2.16	2.74	r	.008 TYP		0.20 TYP	
CL		.128		3.25	r1	.012 TYP		0.30 TYP	
CW		.108		2.74	r2	.022 TYP		0.56 TYP	
LL1	.022	.038	0.56	0.96	r3	.008 TYP		0.20 TYP	
LL2	.017	.035	0.43	0.89	r4	.012 TYP		0.30 TYP	

NOTES:

1. Dimensions are in inches. Millimeters are given for general information only.
2. Ceramic package only.
3. Hatched areas on package denote metallized areas. Pad 4 = shielding, connected to the lid.
4. Dimensions are pre-solder dip.
5. In accordance with ASME Y14.5M, diameters are equivalent to Φ x symbology.

FIGURE 4. Physical dimensions, surface mount (2 pin UB version).

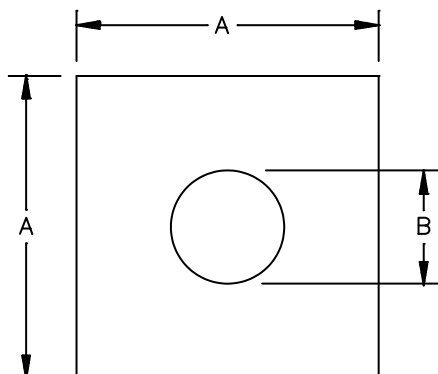

BACKSIDE IS CATHODE



Ltr	Dimensions			
	Inches		Millimeters	
	Min	Max	Min	Max
A	.014	.018	0.360	0.460
B	.005	.007	0.120	0.180
C	.008	.012	0.20	0.30

NOTES:

1. Dimensions are in inches. Millimeters are given for general information only.
2. Element evaluation accomplished utilizing TO-5 package.
3. The physical characteristics of the die are:

Metallization:

Top (anode): Al

Back (cathode): Au

Al thickness: 25,000 Å minimum.

Gold thickness: 4,000 Å minimum.

Chip thickness: .010 inches (0.25 mm) ±.002 inches (0.05 mm).

FIGURE 5. Physical dimensions JANHCA and JANKCA die.

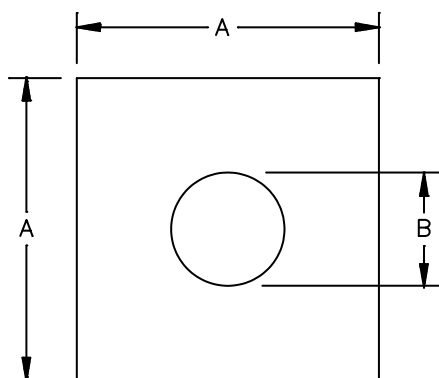

BACKSIDE IS CATHODE



Ltr	Dimensions			
	Inches		Millimeters	
	Min	Max	Min	Max
A	.0130	.0170	0.330	0.432
B	.0059	.0061	0.150	0.155
C	.008	.012	0.20	0.30

NOTES:

1. Dimensions are in inches. Millimeters are given for general information only.
2. Element evaluation accomplished utilizing TO-5 package.
3. The physical characteristics of the die are:

Metallization:

Top (anode): Al

Back (cathode): Au

Al thickness: 25,000 Å minimum.

Gold thickness: 4,000 Å minimum.

Chip thickness: .010 inches (0.25 mm) ±.002 inches (0.05 mm).

* FIGURE 6. Physical dimensions, JANHCB and JANKCB die.

3. REQUIREMENTS

3.1 General. The individual item requirements shall be as specified in MIL-PRF-19500 and as modified herein.

3.2 Qualification. Devices furnished under this specification shall be products that are manufactured by a manufacturer authorized by the qualifying activity for listing on the applicable qualified manufacturers list before contract award (see 4.2 and 6.3).

3.3 Abbreviations, symbols, and definitions. Abbreviations, symbols, and definitions used herein shall be as specified in MIL-PRF-19500.

3.4 Interface and physical dimensions. Interface and physical dimensions shall be as specified in MIL-PRF-19500, and on figure 1, figure 2, figure 3 (UB), figure 4 (UB2), figure 5 (die), and figure 6 (die).

3.4.1 Lead finish. Lead finish shall be solderable in accordance with MIL-PRF-19500, MIL-STD-750, and herein. Where a choice of lead finish is desired, it shall be specified in the acquisition document (see 6.2).

3.4.2 Diode construction. These devices shall be constructed in a manner and using materials which enable the diodes to meet the applicable requirements of MIL-PRF-19500 and this document.

- a. All devices except 'UB' and 'UB2' versions shall be of metallurgically bonded, thermally matched, non-cavity, double-plug construction in accordance with the requirements of category I (see MIL-PRF-19500).
- b. The 'UB' devices shall be eutectically mounted and wire bonded in a ceramic package.
- c. The 'U' and 'US' version shall be structurally identical to the axial leaded versions except for end-cap lead attachment.

3.5 Electrical performance characteristics. Unless otherwise specified herein, the electrical performance characteristics are as specified in 1.3, 1.4, and table I.

3.6 Electrical test requirements. The electrical test requirements shall be as specified in table I herein.

3.7 Marking. Marking shall be in accordance with MIL-PRF-19500. Manufacturer's identification and date code shall be marked on the devices. Initial container package marking shall be in accordance with MIL-PRF-19500. The polarity shall be indicated with a contrasting color band to denote the cathode end. The prefixes JAN, JANTX, JANTXV, and JANS can be abbreviated as J, JX, JV, and JS respectively. The part number may be reduced to J6638, JX6638, JV6638, or JS6638. No color coding shall be permitted for part numbering.

3.7.1 Marking of U and US versions. 'U' and 'US' devices shall be marked with a cathode band as a minimum, or a minimum of three evenly spaced contrasting color dots around the periphery of the cathode end may be used. For 'U' and 'US' versions only, all marking may be omitted from the device except for the cathode marking. At the option of the manufacturer, 'U' and 'US' devices may include laser marking on an end-cap, to include part number and lot date code for all levels. JANS devices which are laser marked shall also include serialization. The prefixes JAN, JANTX, JANTXV, or JANS may be abbreviated as J, JX, JV, or JS, respectively. (For example: The part number may be reduced to JS6642). All marking which is omitted from the body of the device, except for polarity and serial numbers, shall appear on the initial container.

3.7.2 UB devices. 'UB' and 'UB2' packages do not require polarity marking.

3.8 Workmanship. Semiconductor devices shall be processed in such a manner as to be uniform in quality and shall be free from other defects that will affect life, serviceability, or appearance.

4. VERIFICATION

4.1 Classification of inspections. The inspection requirements specified herein are classified as follows:

- a. Qualification inspection (see 4.2).
- b. Screening (see 4.3).
- c. Conformance inspection (see 4.4).

4.2 Qualification inspection. Qualification inspection shall be in accordance with MIL-PRF-19500 and as specified herein.

4.2.1 JANHC and JANKC qualification. JANHC and JANKC qualification inspection shall be in accordance with MIL-PRF-19500.

4.2.2 Group E qualification. Group E inspection shall be performed for qualification or re-qualification only. In case qualification was awarded to a prior revision of the specification sheet that did not require the performance of table II tests, the tests specified in table II herein that were not performed in the prior revision shall be performed on the first inspection lot of this revision to maintain qualification.

4.3 Screening (JANS, JANTXV, and JANTX levels only). Screening shall be in accordance with table E-IV of MIL-PRF-19500 and as specified herein. Specified electrical measurements shall be made in accordance with table I herein. Devices that exceed the limits of table I herein shall not be acceptable.

Screen (see table E-IV of MIL-PRF-19500)	JANS level	JANTXV and JANTX level
2	Not required	Not required
3b (1) 3c	Not applicable Thermal impedance (see 4.3.3)	Not applicable Thermal impedance (see 4.3.3)
4	Not applicable	Not applicable
5	Not applicable for axial leaded parts	Not applicable
6	Not applicable	Not applicable
9	I_{R1}	Not applicable
10	Method 1038 of MIL-STD-750, condition A	Method 1038 of MIL-STD-750, condition A
11	V_{F2} , I_{R1} , and V_{BR} ; $\Delta I_{R1} \pm 15$ nA dc or 100 percent of initial value whichever is greater.	V_{F2} and I_{R1}
12	Required, see 4.3.2	Required, see 4.3.2
13	Subgroups 2 and 3 of table I herein; $\Delta I_{R1} \leq 100$ percent of initial reading or 15 nA dc, whichever is greater. $\Delta V_{F2} \leq \pm 0.030$ V dc (scope display, see 4.5.3).	Subgroup 2 of table I herein; $\Delta I_{R1} \leq 100$ percent of initial reading or 15 nA dc, whichever is greater. $\Delta V_{F2} \leq \pm 0.030$ V dc (scope display, see 4.5.3).

(1) Shall be performed anytime after temperature cycling, screen 3a; JANTX and JANTXV levels do not need to be repeated in screening requirements.

4.3.1 Screening (JANHC and JANKC). Screening of JANHC and JANKC die shall be in accordance with appendix G of MIL-PRF-19500. Burn-in duration for the JANKC level follows JANS requirements; the JANHC follows JANTX requirements.

4.3.2 Power burn-in conditions. Power burn-in conditions are as follows (see 4.5.1): Method 1038 of MIL-STD-750, condition B. V_R = rated V_{RWM} ; $f = 50 - 60$ Hz; $I_O(\text{min})$ or $I_F(\text{min}) = I_O(\text{PCB})$. $T_A = 75^\circ\text{C}$ maximum. The maximum current density of small die shall be submitted to the qualifying activity for approval. With approval of the qualifying activity and preparing activity, alternate burn-in criteria (hours, bias conditions, and mounting conditions) may be used for JANTX and JANTXV quality levels. A justification demonstrating equivalence is required. In addition, the manufacturing site's burn-in data and performance history will be essential criteria for burn-in modification approval.

4.3.3 Thermal impedance measurements. The thermal impedance measurements shall be performed in accordance with method 3101 or 4081 of MIL-STD-750, as applicable, using the guidelines in that method for determining I_H and I_M . Measurement delay time (t_{MD}) = 70 μs max, t_H shall be 10 ms maximum. The thermal impedance limit shall comply with the thermal impedance graphs in figures 9, 10, 11, 12, and 13 (less than or equal to the curve value at the same t_H time) and shall be less than the process determined statistical maximum limit as outlined in method 3101 or 4081 of MIL-STD-750, as applicable. See group E, subgroup 4 of table II herein.

4.4 Conformance inspection. Conformance inspection shall be in accordance with MIL-PRF-19500.

4.4.1 Group A inspection. Group A inspection shall be conducted in accordance with table E-V of MIL-PRF-19500, table I herein, and as specified herein. Electrical measurements (end-points) shall be in accordance with table I, subgroup 2 herein.

4.4.2 Group B inspection. Group B inspection shall be conducted in accordance with the conditions specified for subgroup testing in tables E-VIA (JANS) and E-VIB (JAN, JANTX, and JANTXV) of MIL-PRF-19500 and 4.4.2.1 and 4.4.2.2 herein. Electrical measurements (end-points) shall be in accordance with table I, subgroup 2 herein. Read and record the change in thermal impedance. The accept criteria is a maximum change of 10 percent for group B, subgroups 3 and 4 for JANS, or group B, subgroup 2 for JANTX or JANTXV.

4.4.2.1 Group B inspection, table E-VIA (JANS) of MIL-PRF-19500.

<u>Subgroup</u>	<u>Method</u>	<u>Conditions</u>
B3	1056	0°C to $+100^\circ\text{C}$, 25 cycles. (Not applicable for UB suffix parts.)
B3	1051	-55°C to $+175^\circ\text{C}$, 100 cycles.
B3	2101	Decap analysis; scribe and break only. (Scribe and break not applicable for UB)
B4	1037	$t_{ON} = t_{OFF} = 1$ minute minimum; 2,000 cycles; $I_O = 300$ mA, pulsed; in lieu of ac conditions, a dc condition of $I_F = 300$ mA may be used.
B5	1027	$I_O = 300$ mA minimum, $V_R = \text{rated } V_{RWM}$, $f = 50 - 60$ Hz (see 4.5.1). Option 1: Adjust I_O or T_A to obtain a minimum T_J of $+225^\circ\text{C}$, $t = 216$ hours, $n = 45$, $c = 0$. Option 2: Adjust I_O or T_A to obtain a minimum T_J of $+175^\circ\text{C}$, $t = 1,000$ hours, $n = 45$, $c = 0$.

MIL-PRF-19500/578M

4.4.2.2 Group B inspection, table E-VIB (JAN, JANTX, and JANTXV) of MIL-PRF-19500. Leaded samples from the same lot may be used in lieu of U and US suffix sample for life test.

<u>Subgroup</u>	<u>Method</u>	<u>Conditions</u>
B2	1056	0°C to + 100°C, 10 cycles. (Not applicable for UB suffix parts.)
B2	1051	-55°C to +175°C, 45 cycles including screening.
B3	1027	$V_{(pk)} = \text{rated } V_{RWM}$; $f = 50 - 60 \text{ Hz}$; $I_O = 300 \text{ mA dc}$ minimum; adjust T_A or I_O to obtain a minimum T_J of +150°C. (See 4.5.1.)
B4	2101	Decap analysis; scribe and break only. Not applicable for UB device types.
B6	1032	$T_A = +175^\circ\text{C}$.

4.4.3 Group C inspection. Group C inspection shall be conducted in accordance with the conditions specified for subgroup testing in table E-VII of MIL-PRF-19500, and as follows. Electrical measurements (end-points) shall be in accordance with [table I](#), subgroup 2 herein.

4.4.3.1 Group C inspection, table E-VII of MIL-PRF-19500.

<u>Subgroup</u>	<u>Method</u>	<u>Conditions</u>
C2	1056	0°C to + 100°C, 10 cycles. (Not applicable for UB suffix parts.)
C2	1051	-55°C to + 175°C, 45 cycles including screening.
*	C2	2036 Axial devices - Tension: Condition A, 6 pounds, $t = 15 \text{ s}$. Fatigue: Condition E for all types.
*	C2	2036 US devices - Tension: Condition A, 6 pounds, $t = 15 \text{ s}$. Suitable fixtures may be used to pull the end-caps in a manner which does not aid construction. Reference to axial lead may be interpreted as end-cap with fixtures used for mounting. (Lead fatigue is not applicable to US diodes).
C5	4081	$L = .375 \text{ inch (9.53 mm)}$; $R_{\theta JL} = 150^\circ\text{C/W}$ maximum; $R_{\theta JEC} = 40^\circ\text{C/W}$ maximum (see 4.3.3).
C6	1026	1,000 hours minimum, $V_{(pk)} = \text{rated } V_{RWM}$; $f = 50 - 60 \text{ Hz}$; $I_O = 300 \text{ mA dc}$ minimum; adjust T_A or I_O to obtain a minimum T_J of +150°C. (See 4.5.1.)

4.4.4 Group E inspection. Group E inspection shall be conducted in accordance with the tests and conditions specified for subgroup testing in table E-IX of MIL-PRF-19500, and [table II](#) herein. Electrical measurements (end-points) shall be in accordance with [table I](#), subgroup 2 herein.

4.5 Methods of inspection. Methods of inspection shall be as specified in the appropriate tables and as follows.

4.5.1 Free air power burn-in and life tests. The use of a current limiting or ballast resistor is permitted provided that each device under test still sees the full P_t (minimum) and that the minimum applied voltage, where applicable, is maintained through-out the burn-in period. Method 3100 of MIL-STD-750 shall be used to measure T_J .

4.5.2 Forward-recovery voltage and time. Forward recovery time shall be measured as the time interval between zero time and the point where the V_F pulse has decreased to 110 percent of the steady-state value of V_F when $I_F = 200$ mA dc. The maximum rise time of the response detector shall be 1 ns. The maximum forward recovery voltage (V_{fr}) during the forward recovery interval shall also be measured.

4.5.3 Scope display evaluation. Scope display evaluation shall be stable in accordance with method 4023 of MIL-STD-750. Scope display may be performed on automatic test equipment for screening only with the approval of the qualifying activity. Scope display in table I herein shall be performed on an oscilloscope. Reverse current (I_{BR}) over the knee shall be 100 μ A peak.

4.5.4 Pulse measurements. Conditions for pulse measurements shall be as specified in section 4 of MIL-STD-750.

MIL-PRF-19500/578M

TABLE I. Group A inspection.

Inspection <u>1/</u> <u>2/</u>	MIL-STD-750		Symbol	Limits		Unit
	Method	Conditions		Min	Max	
<u>Subgroup 1</u>						
Visual and mechanical examination	2071					
<u>Subgroup 2</u>						
Thermal impedance	3101	See 4.3.3	Z _{θJX}			°C/W
Forward voltage	4011	I _F = 10 mA dc pulsed (see 4.5.4)	V _{F1}			
1N6638					.8	V dc
1N6642					.8	V dc
1N6643					.8	V dc
Forward voltage	4011		V _{F2}			
1N6638		I _F = 200 mA pulsed (see 4.5.4)			1.1	V dc
1N6642		I _F = 100 mA pulsed (see 4.5.4)			1.2	V dc
1N6643		I _F = 100 mA pulsed (see 4.5.4)			1.2	V dc
Breakdown voltage	4021	I _R = 100 μA dc	V _{BR}			
1N6638				150		V dc
1N6642				100		V dc
1N6643				75		V dc
Reverse current	4016	DC method; V _R = 20 V dc	I _{R1}			
1N6638					35	nA dc
1N6642					25	nA dc
1N6643					50	nA dc
Reverse current	4016	DC method	I _{R2}			
1N6638		V _R = 125 V dc			500	nA dc
1N6642		V _R = 75 V dc			500	nA dc
1N6643		V _R = 50 V dc			500	nA dc
<u>Subgroup 3</u>						
High temperature operation		T _A = +150°C				
Reverse current	4016	DC method, V _R = 20 V dc	I _{R3}			
1N6638					50	μA dc
1N6642					50	μA dc
1N6643					75	μA dc

See footnotes at end of table.

MIL-PRF-19500/578M

TABLE I. Group A inspection - Continued.

Inspection <u>1/</u> <u>2/</u>	MIL-STD-750		Symbol	Limits		Unit
	Method	Conditions		Min	Max	
<u>Subgroup 3</u> - continued						
Reverse current 1N6638 1N6642 1N6643	4016	DC method $V_R = 125$ V dc $V_R = 75$ V dc $V_R = 50$ V dc	I_{R4}		100 100 100	μ A dc μ A dc μ A dc
Forward voltage 1N6638 1N6642, 1N6643	4011	$I_F = 10$ mA dc pulsed (see 4.5.4)	V_{F3}		.65 .80	V dc V dc
Low temperature operation		$T_A = -55^\circ\text{C}$				
Forward voltage 1N6638 1N6642 1N6643	4011	Pulsed $I_F = 200$ mA pulsed (see 4.5.4) $I_F = 100$ mA pulsed (see 4.5.4) $I_F = 100$ mA pulsed (see 4.5.4)	V_{F4}		1.2 1.2 1.4	V dc V dc V dc
<u>Subgroup 4</u>						
Capacitance 1N6638 1N6642 1N6643	4001	$V_R = 0$ V dc; $V_{sig} = 50$ mV(p-p) $f = 1$ MHz	C_{T1}		2.5 5.0 5.0	pF pF pF
Capacitance 1N6638 1N6642 1N6643	4001	$V_R = 1.5$ V dc; $V_{sig} = 50$ mV(p-p) $f = 1$ MHz	C_{T2}		2.0 2.8 2.8	pF pF pF

See footnotes at end of table.

TABLE I. Group A inspection - Continued.

Inspection <u>1/</u> <u>2/</u>	MIL-STD-750		Symbol	Limits		Unit
	Method	Conditions		Min	Max	
<u>Subgroup 4</u> - continued						
Reverse recovery time 1N6638 1N6642 1N6643	4031	Condition A, $I_F = I_R = 10$ mA dc	t_{rr}		4.5 5.0 6.0	ns ns ns
Scope display <u>Subgroup 5</u>	4023	See method 4023 of MIL-STD-750, figures 4023-3, -7, -9, -10 only				
Not applicable <u>Subgroup 6</u>	4066					
Surge current		$I_{FSM} = 2.5$ A(pk) ten surges at one per minute (max), surge duration of 1/120 seconds				
Electrical measurements <u>Subgroup 7</u>		See table I , subgroup 2				
Forward recovery voltage and time	4026	$I_F = 200$ mA dc (see 4.5.2)	V_{fr} t_{fr}		5.0 20.0	V(pk) ns

1/ For sampling plan, see MIL-PRF-19500.

2/ Electrical characteristics for surface mount versions are identical to the corresponding axial leaded versions unless otherwise specified.

MIL-PRF-19500/578M

TABLE II. Group E inspection (all quality levels) for qualification and requalification only.

Inspection <u>1/</u>	MIL-STD-750		Sample plan
	Method	Conditions	
<u>Subgroup 1</u>			n = 45, c = 0
Thermal shock (glass strain) <u>1/</u>	1056	20 cycles, condition D except low temperature shall be achieved using liquid nitrogen (-195°C). A visual inspection for cracked glass shall be performed. (Not applicable for UB suffix parts.)	
Temperature cycling <u>1/</u>	1051	-65°C to +175°C.	
Hermetic seal	1071	Gross leak only. Fine and gross for "UB" devices.	
Electrical tests		See table I , subgroup 2.	
<u>Subgroup 2</u>			n = 45, c = 0
Intermittent operation life	1037	10,000 cycles; I _F = I _O = 300 mA dc, T _{on} = T _{off} = 1 minute.	
Electrical end-points		See table I , subgroup 2.	
<u>Subgroup 4</u>			
Thermal resistance	4081	R _{θJS} P can be calculated but shall be measured once in the same package with a similar die size to confirm calculations (may apply to multiple specification sheets).	n = 15, c = 0
Thermal impedance curves		See MIL-PRF-19500, table E-IX, group E, subgroup 4.	Sample size N/A
<u>Subgroup 5</u>			
Not applicable			
<u>Subgroup 6</u>			
ESD	1020		n = 11
<u>Subgroup 8</u>			
Resistance to glass cracking	1057	Test condition B. Test until failure occurs or to a maximum of 25 cycles, whichever comes first. Not required for UB devices.	n = 45
<u>Subgroup 10</u>			
Potted environment test	1054	Not required for UB packages	n = 22, c = 0

1/ Separate samples may be used for each test.

TEMPERATURE – CURRENT DERATING CURVE
Axial and 'US' parts $T_A = 25^\circ\text{C}$

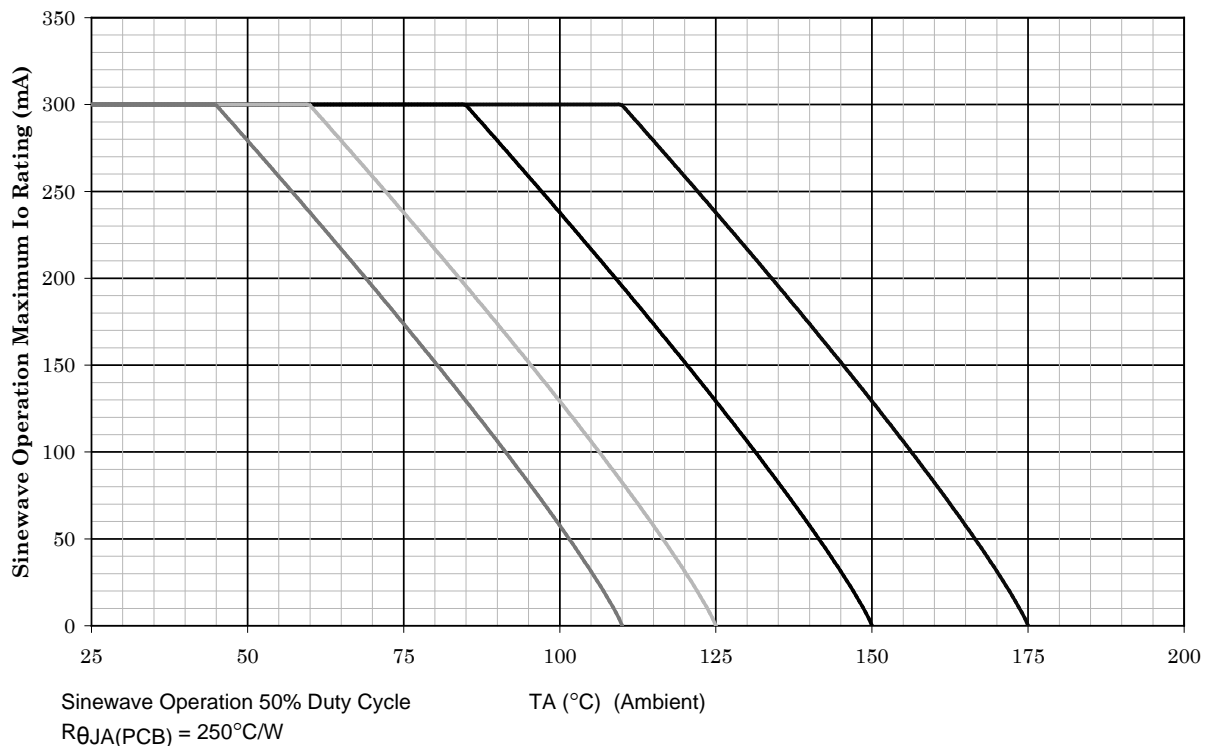

NOTES:

1. All devices are capable of operating at $\leq T_J$ specified on this curve. Any parallel line to this curve will intersect the appropriate current for the desired maximum T_J allowed.
2. Derate design curve constrained by the maximum junction temperatures and current rating specified. (See 1.3.)
3. Derate design curve chosen at $T_J \leq 150^\circ\text{C}$, where the maximum temperature of electrical test is performed.
4. Derate design curves chosen at $T_J \leq 125^\circ\text{C}$, and 110°C to show current rating where most users want to limit T_J in their application.

FIGURE 7. Temperature current derating.

**TEMPERATURE – CURRENT DERATING CURVE
1N6642UB, UB2**

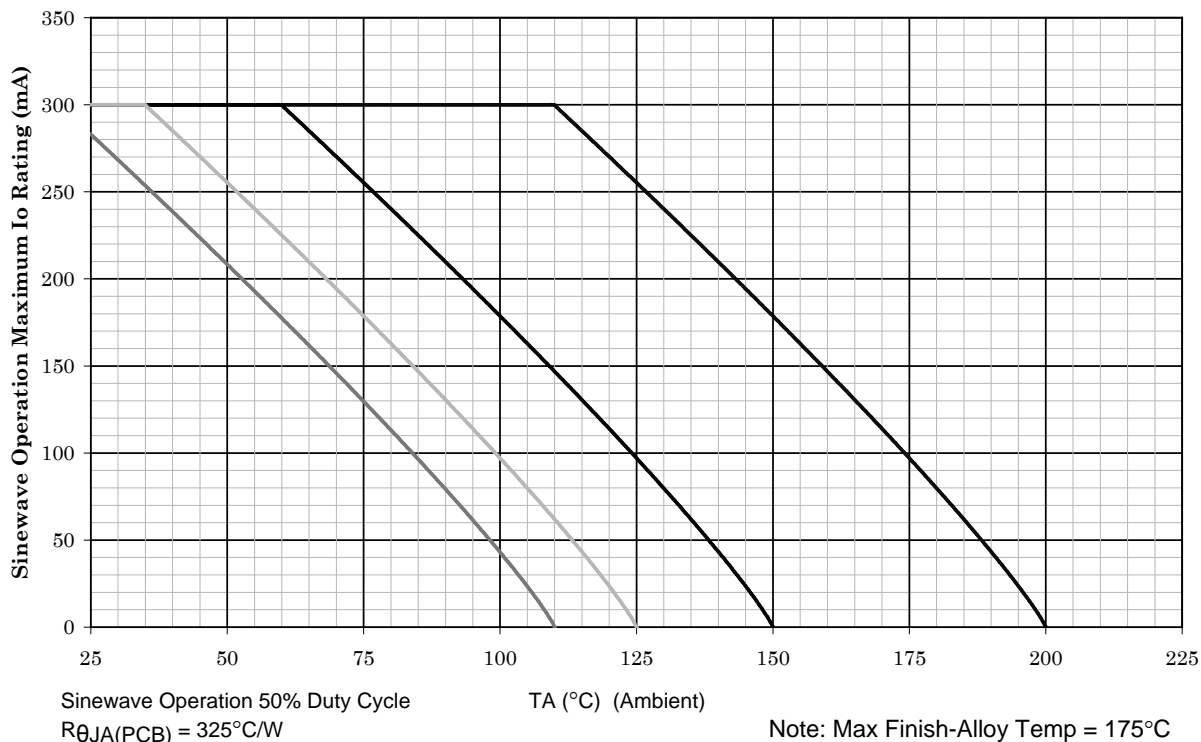

NOTES:

1. All devices are capable of operating at $\leq T_J$ specified on this curve. Any parallel line to this curve will intersect the appropriate current for the desired maximum T_J allowed.
2. Derate design curve constrained by the maximum junction temperatures and current rating specified. (See 1.3.)
3. Derate design curve chosen at $T_J \leq 150^\circ\text{C}$, where the maximum temperature of electrical test is performed.
4. Derate design curves chosen at $T_J \leq 125^\circ\text{C}$, and 110°C to show current rating where most users want to limit T_J in their application.

FIGURE 8. Temperature current derating.

**Maximum Thermal Impedance Plots
Axial, 'U', 'US' parts, $T_A = 55^\circ\text{C}$**

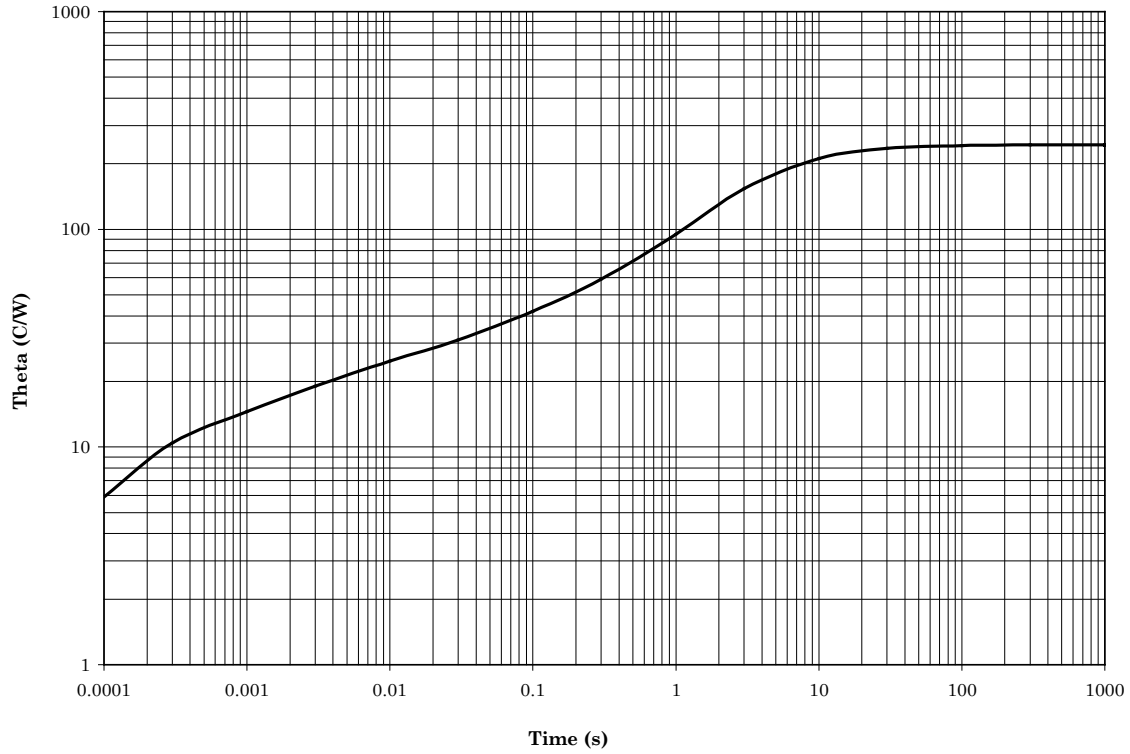

$R_{\theta JA(PCB)} = 250^\circ\text{C/W}$

NOTE: $Z_{\theta JX} = 25^\circ\text{C/W}$ maximum at $t_H = 10\text{ms}$.

FIGURE 9. Thermal impedance - all glass devices.

**Maximum Thermal Impedance Plots
'U', 'US' parts, $T_{EC} = 25^{\circ}\text{C}$**

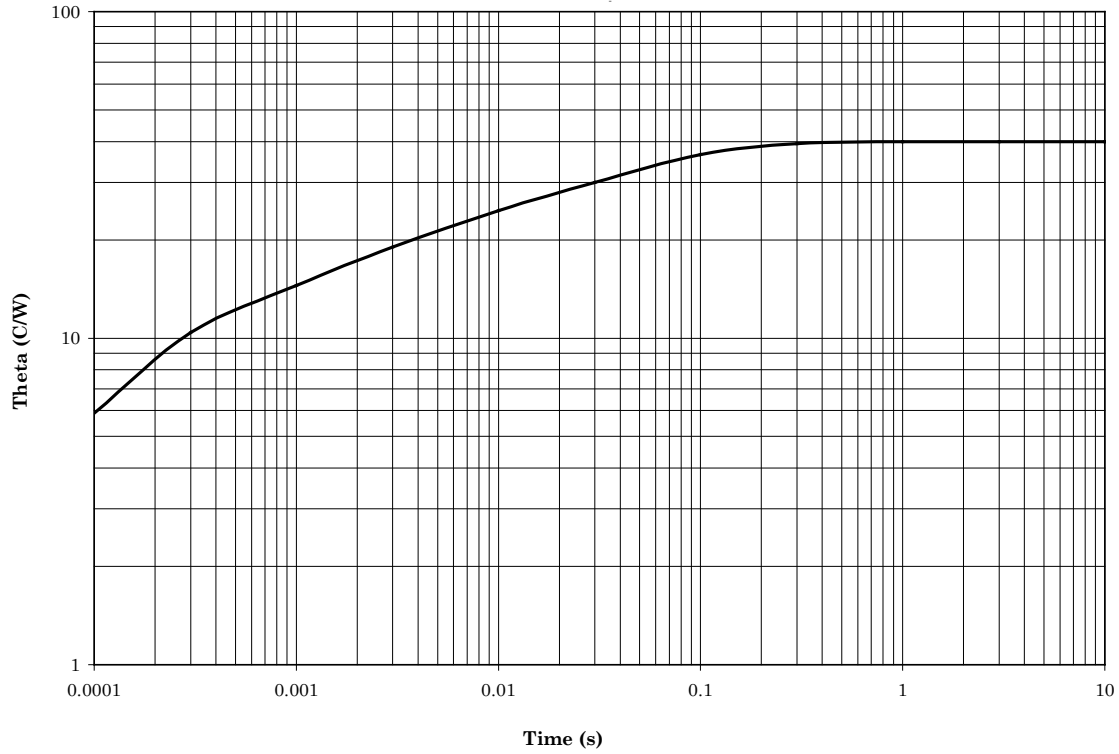

$R_{\theta JEC} = 40^{\circ}\text{C/W}$

NOTE: $Z_{\theta JX} = 25^{\circ}\text{C/W}$ maximum at $t_H = 10\text{ms}$.

FIGURE 10. Thermal impedance - all U and US devices.

**Maximum Thermal Impedance Plots
Axial parts, $T_L = 25^\circ\text{C}$**

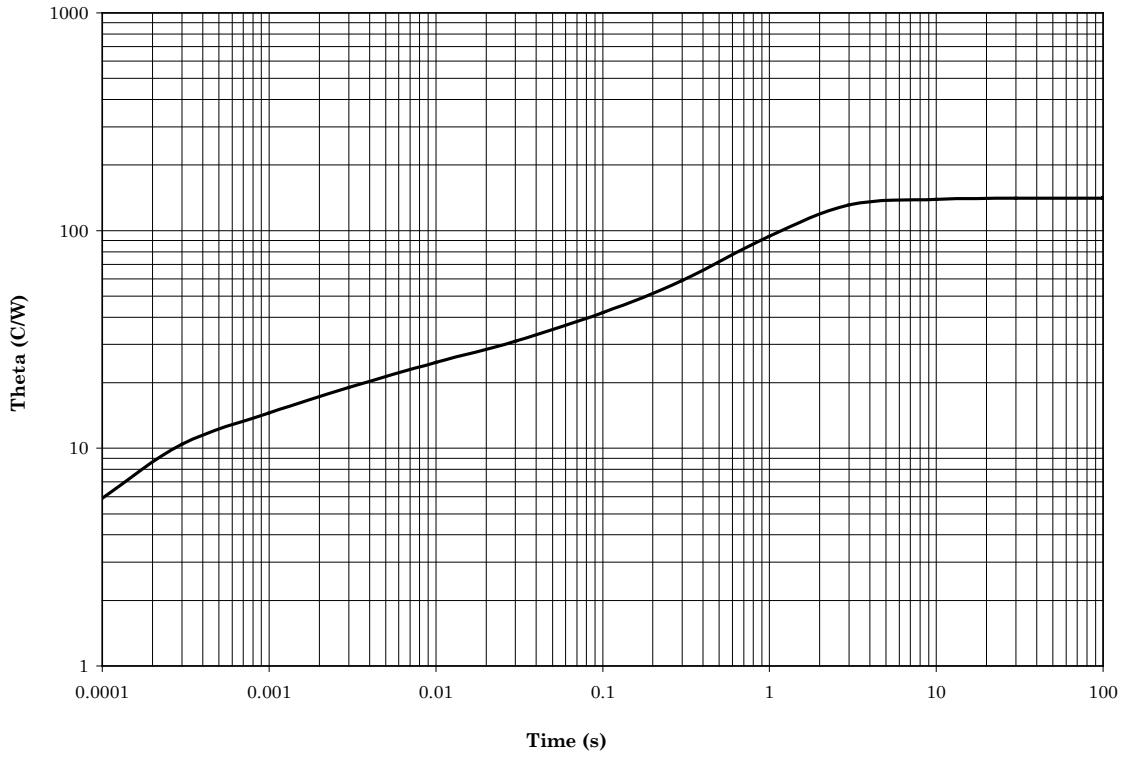

$R_{\theta JL} = 150^\circ\text{C/W}$

NOTE: $Z_{\theta JX} = 25^\circ\text{C/W}$ maximum at $t_H = 10\text{ms}$.

FIGURE 11. Thermal impedance (axial leads).

**Maximum Thermal Impedance Plots
UB Package on FR-4 PCB, $T_A = 25^\circ\text{C}$**

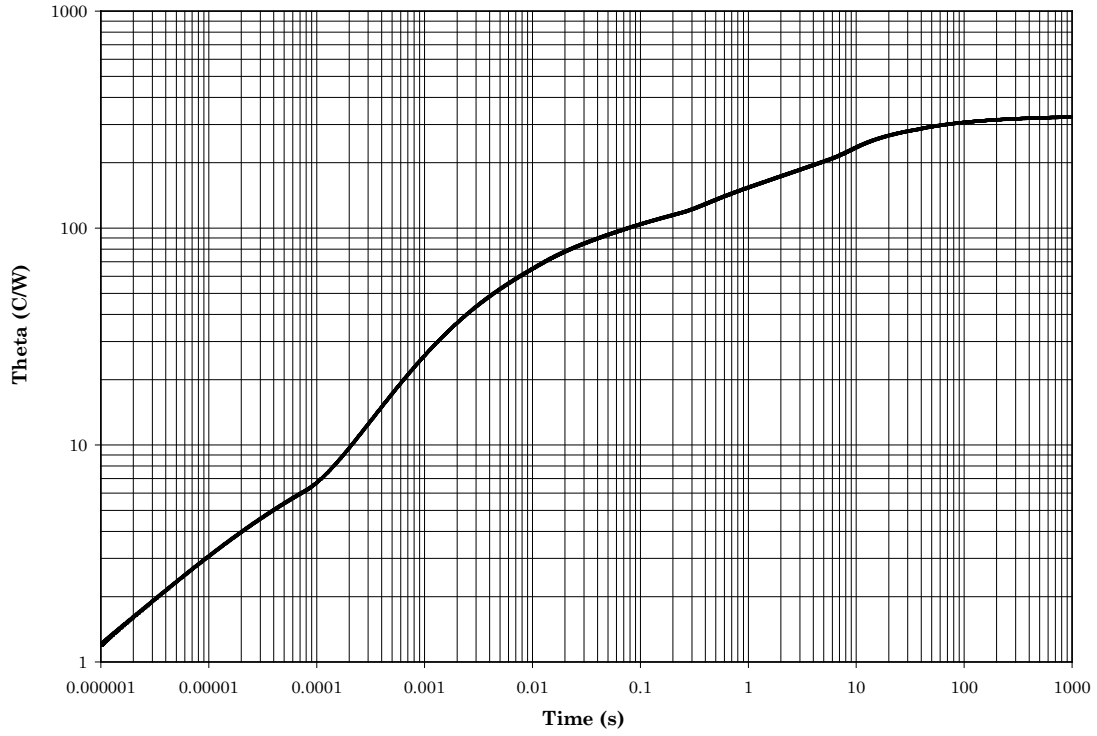

$R_{\theta JA(\text{PCB})} = 325^\circ\text{C/W}$

NOTE: $Z_{\theta JX} = 65^\circ\text{C/W}$ maximum at $t_H = 10\text{ms}$.

FIGURE 12. Thermal impedance (UB versions).

**Maximum Thermal Impedance Plots
UB Package on FR-4 PCB, T_{SP} = 25°C**

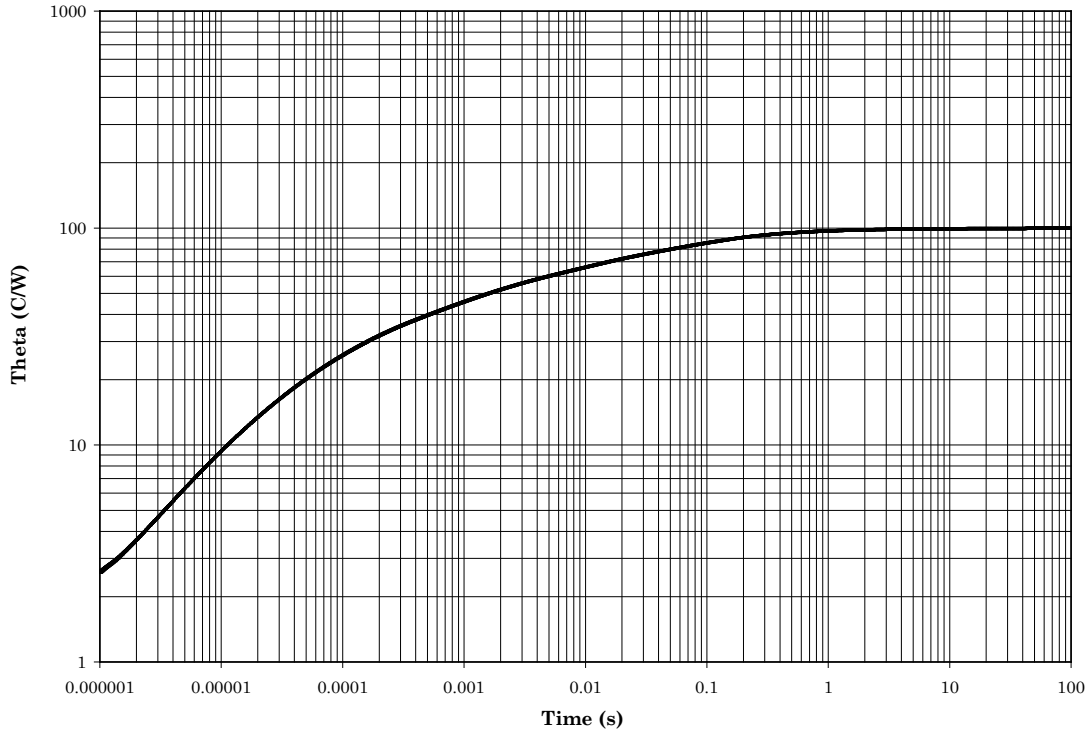

$R_{\theta JSP} = 100^{\circ}\text{C/W}$

NOTE: $Z_{\theta JX} = 65^{\circ}\text{C/W}$ maximum at $t_H = 10\text{ms}$.

FIGURE 13. Thermal impedance (UB versions).

5. PACKAGING

5.1 Packaging. For acquisition purposes, the packaging requirements shall be as specified in the contract or order (see 6.2). When packaging of materiel is to be performed by DoD or in-house contractor personnel, these personnel need to contact the responsible packaging activity to ascertain packaging requirements. Packaging requirements are maintained by the Inventory Control Point's packaging activities within the Military Service or Defense Agency, or within the Military Service's system commands. Packaging data retrieval is available from the managing Military Department's or Defense Agency's automated packaging files, CD-ROM products, or by contacting the responsible packaging activity.

6. NOTES

(This section contains information of a general or explanatory nature that may be helpful, but is not mandatory. The notes specified in MIL-PRF-19500 are applicable to this specification.)

6.1 Intended use. Semiconductors conforming to this specification are intended for original equipment design applications and logistic support of existing equipment.

6.2 Acquisition requirements. Acquisition documents should specify the following:

- a. Title, number, and date of this specification.
- b. Packaging requirements (see 5.1).
- c. Lead finish (see 3.4.1).
- d. Product assurance level and type designator.

6.3 Qualification. With respect to products requiring qualification, awards will be made only for products which are, at the time of award of contract, qualified for inclusion in Qualified Manufacturers List (QML 19500) whether or not such products have actually been so listed by that date. The attention of the contractors is called to these requirements, and manufacturers are urged to arrange to have the products that they propose to offer to the Federal Government tested for qualification in order that they may be eligible to be awarded contracts or orders for the products covered by this specification. Information pertaining to qualification of products may be obtained from DLA Land and Maritime, ATTN: VQE, P.O. Box 3990, Columbus, OH 43218-3990 or e-mail vqe.chief@dla.mil. An online listing of products qualified to this specification may be found in the Qualified Products Database (QPD) at <https://assist.dla.mil>.

6.4 Cross reference substitution list. JANS1N4148-1 design is unsuitable for space flight applications and is therefore prohibited and will no longer be built nor qualified. Devices in stock are acceptable provided the date code does not exceed 9208. A PIN for PIN replacement table follows, and these devices are directly interchangeable. The JANS1N6642 will be used in place of the JANS1N4148-1. The 1N6638US, 1N6642US, and 1N6643US are structurally identical, are the preferred part numbers, and are directly substitutable for the 1N6638U, 1N6642U, and 1N6643U. The 1N6638U, 1N6642U, and 1N6643U shall not be used for new design.

Non-preferred PIN	Preferred PIN
JANS1N4148-1	JANS1N6642
JANS1N4148UR-1	JANS1N6642US
JANS1N6638U	JANS1N6638US
JANS1N6642U	JANS1N6642US
JANS1N6643U	JANS1N6643US