



Quick Start Guide

QG001006

JetCis

Evaluation Platform for Mira Sensor Family

For All Evaluation Kits Based on NVIDIA Jetson Nano

v1-00 • 2021-Feb-04

Content Guide

1	Introduction	3	5.3	Python Scripting, API and More	17
1.1	Description.....	3	5.4	Shutting Down the System	18
1.2	Key Features	3	6	Transferring Data to Another Computer	19
2	Out of the Box.....	4	7	Updating the Software.....	20
3	Hardware Description	5	7.1	Updating the GUI Software.....	20
3.1	NVIDIA Jetson Nano Schematic View	5	8	Resolving Common Problems....	21
3.2	Connecting the Hardware.....	6			
3.3	Powering Up the System.....	7			
4	ISP Architecture	8			
5	Software Description	9			
5.1	The GNOME Desktop	9			
5.2	JetCis GUI	11			

1 Introduction

1.1 Description

JetCis is a platform for evaluating CMOS image sensors of the Mira product family. The platform is built on top of an NVIDIA Jetson Nano developer kit. The purpose of this guide is not to explain the sensor functionality, nor will it replace the NVIDIA Jetson manual. For that purpose, please refer to the appropriate datasheet/manual. The goal of this document is to get started quickly with this evaluation kit, to connect the camera board to the NVIDIA Jetson, to explain the GUI and how to take pictures with the kit. The EVK (Evaluation Kit) does not need an external computer to be operated, instead the NVIDIA Jetson runs a modified version of GNU/Linux Ubuntu 18.04 and can be operated by connecting keyboard, mouse and monitor.

1.2 Key Features

- Raw image capture for sensor evaluation
- H.264 video capture
- Dual camera support
- API with python example scripts for image capture automation
- Hardware accelerated NVIDIA ISP pipeline

2 Out of the Box

The kit contains the following items out of the box. Please check if all items listed below are in the box.

- NVIDIA Jetson Nano
- Sensor board with lens, lens holder, VCSEL
- Connector cable for sensor board
- Tripod with adaptor for sensor board mounting
- Power supply EU/UK/US
- Flash drive with documentation

Carefully follow all the steps in the next chapter. Make sure the power supply is not yet connected before booting. Always make sure the power adapter is disconnected when connecting or disconnecting any other hardware.

Figure 1:
Typical Setup of the Evaluation Kit



CAUTION

1. Do not connect or disconnect the sensor boards while the system is powered on. This could cause short circuits and may damage the system.
2. Do not put anything on top of the Jetson board as this might cause short circuits.

3 Hardware Description

3.1 NVIDIA Jetson Nano Schematic View

Figure 2:
Schematic Overview of the Jetson Nano Connections, Featuring 2 Camera Connectors.

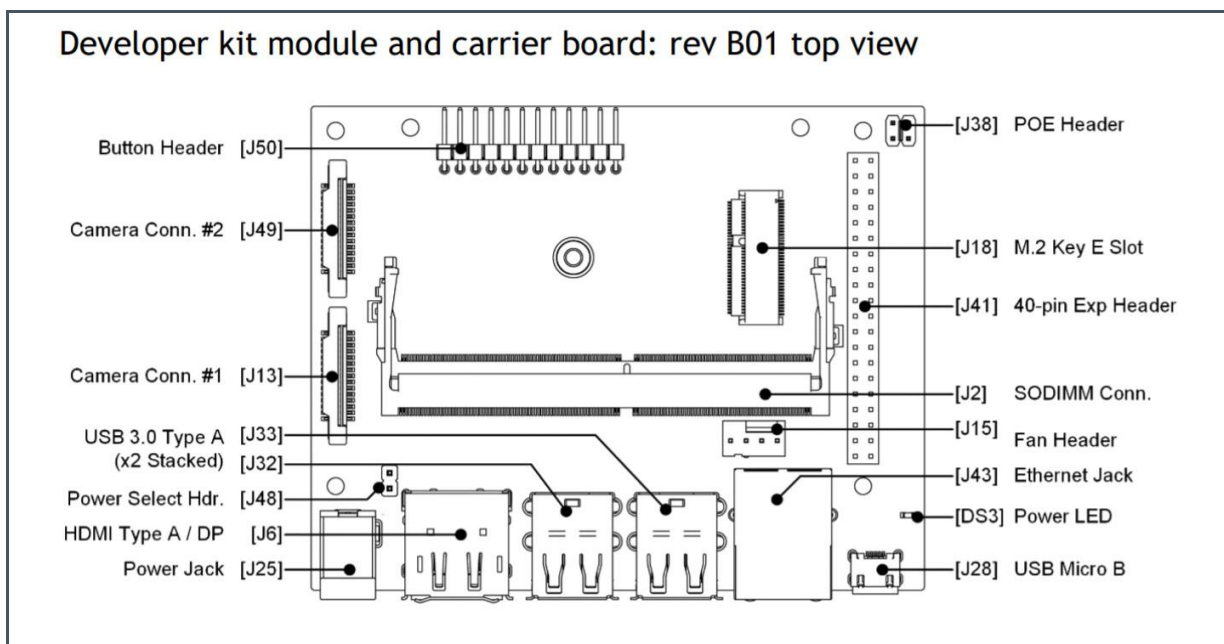

3.2 Connecting the Hardware

Figure 3:
Jetson Nano Connections. Mind the Orientation of the Blue Part of the Cable

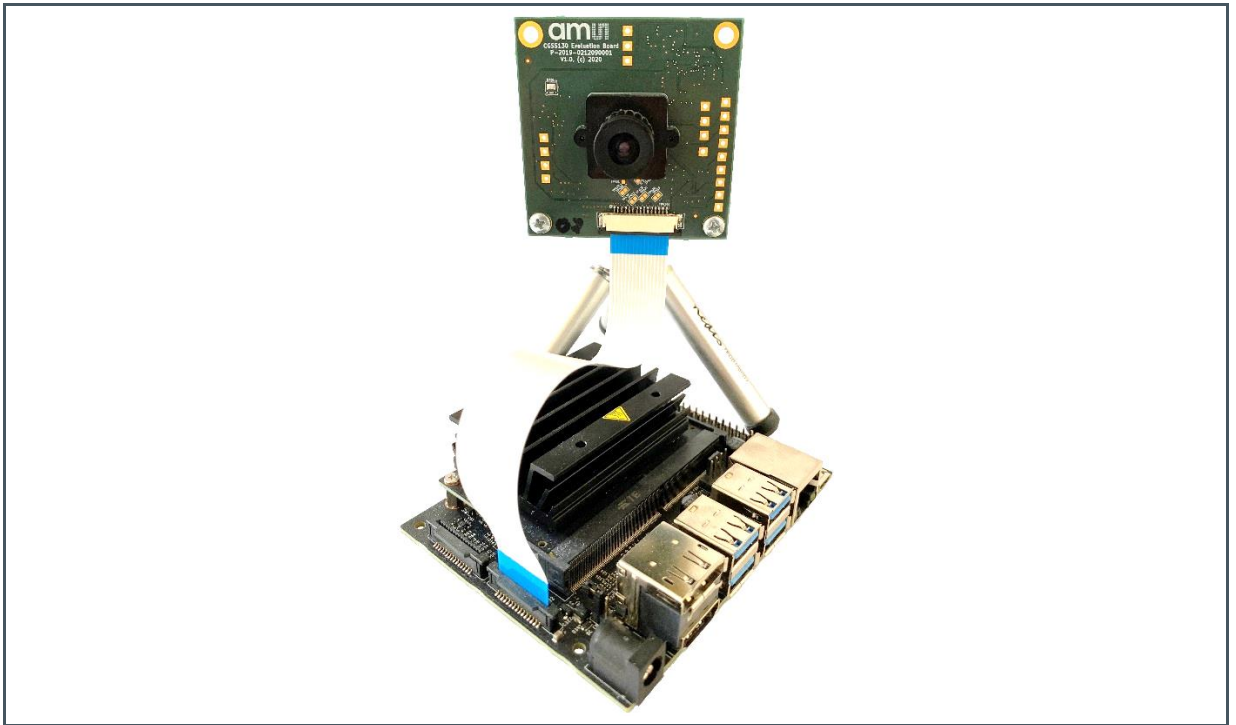

Connecting the Jetson Nano to the sensor board is done by opening the connectors both on the sensor board and on the Jetson Nano board. Make sure to insert the cable in the Camera Conn.1 port on the right. Insert the flex cable as depicted on Figure 3. An optional, second camera board can be connected to Camera Con#2 port.

Connect the Nano to the sensor board using the flex cable. Mind the orientation of the blue part.

The EVK does not include a keyboard, mouse and display. The user can use his own hardware instead. Four USB ports are available, which can be used for keyboard and mouse. Next, there is an HDMI and DisplayPort available for a display. For the internet connection, Ethernet LAN is available.

Connect other hardware such as monitor, keyboard and mouse.

3.3 Powering Up the System

The Jetson Nano does not have a power button. There are two ways to power the Jetson Nano, either with a 5 V barrel jack, or via a micro USB connector. To power on the system, plug in the cable in the appropriate connector (J25 or J28 in Figure 2). Depending on the power input source, the J48 jumper may have to be removed. Refer to Nvidia documentation for more information.

The system will then boot up once power is connected.

Plug in the barrel 5 V power supply or the microUSB cable.

4 ISP Architecture

The JetCis system integrates two image pipelines.

One is able to capture RAW, unprocessed images. These images are often desired to judge the image quality of the image sensor or to perform characterization of certain parameters.

On the other hand, we have the ISP pipeline that is used for the live view in the GUI, as well as for capturing video. This pipeline is able to do hardware accelerated image scaling, automatic gain, lens correction, gamma correction, edge enhancement and more.

Figure 4:
Simplified Image Pipeline

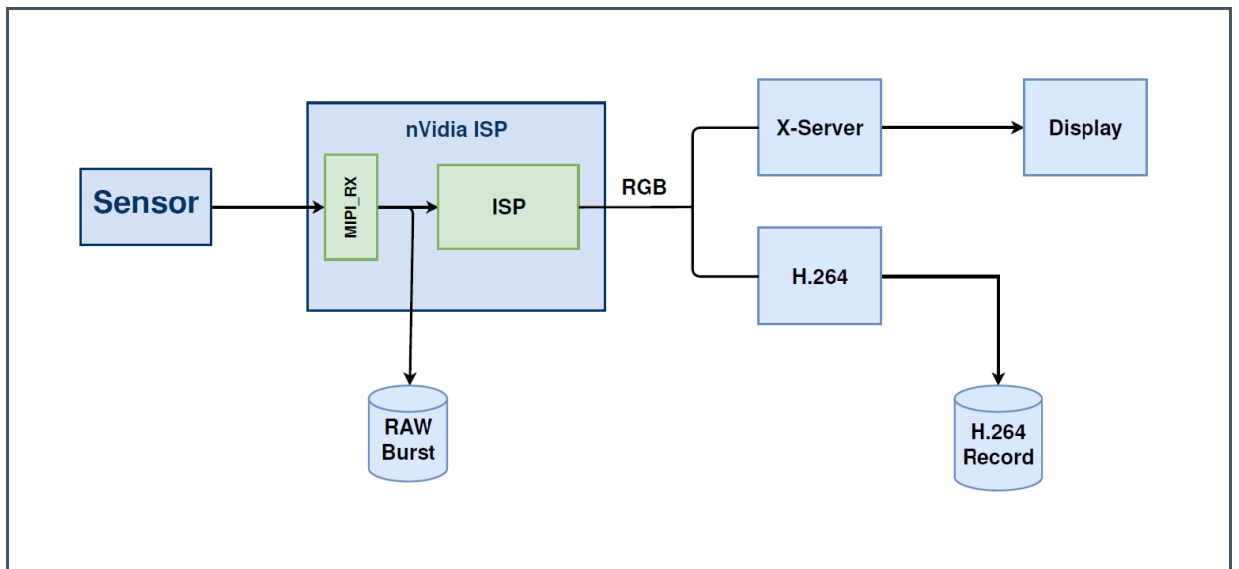

5 Software Description

This chapter will explain how to use the graphical user interface of the EVK. Before proceeding to this step, check if the system is powered on, and the login screen appears.

5.1 The GNOME Desktop

Figure 5:
Desktop/Main Screen

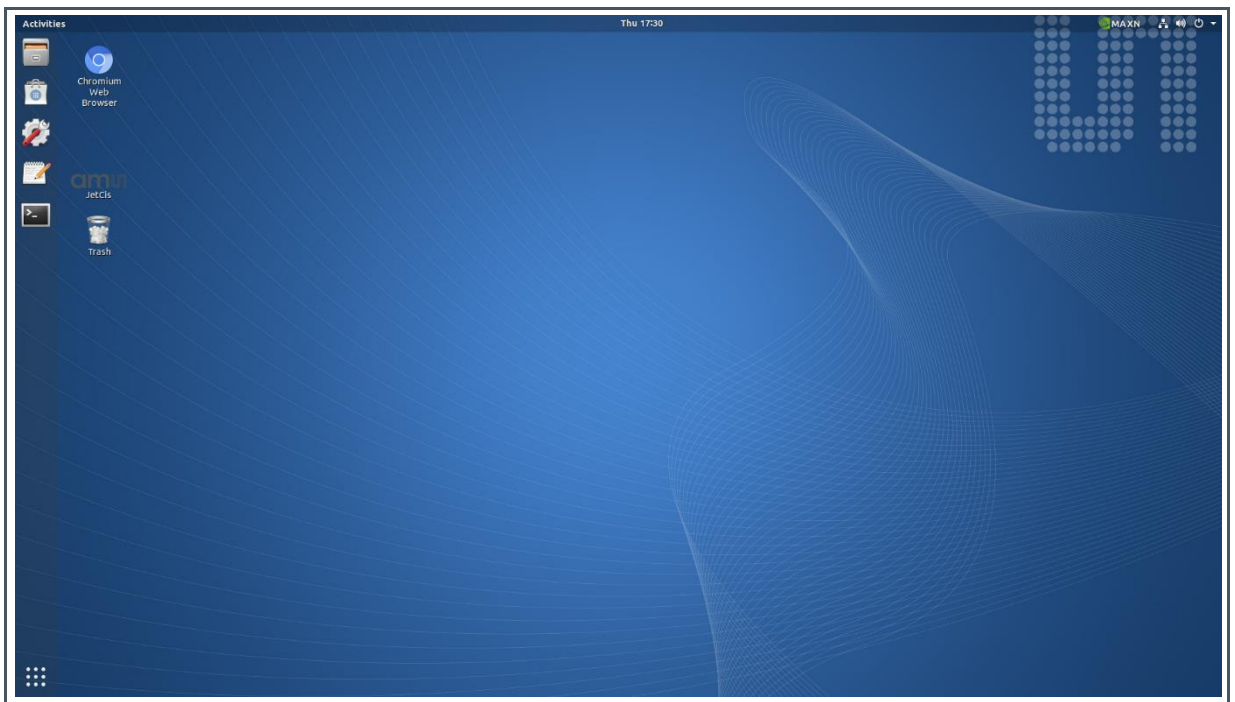

After booting, the GNOME desktop will appear. On the left, there is the sidebar, with various useful applications such as a file browser, a text editor, an internet browser, a terminal and a system settings shortcut. On the desktop, you will find a shortcut to launch the **ams** GUI.

For more general information on the GNOME desktop environment, please refer to the Gnome desktop website (<https://www.gnome.org/>)

5.1.1 Configuring the Screen Resolution

For an optimal experience, the resolution of the system should match the resolution of the connected monitor. To change the resolution, press Start key (bottom left), Win key or ALT + F1 + Enter on your keyboard and search for Displays. There you should find an option to adjust the display resolution and scaling options.

5.1.2 Configuring the Keyboard Layout

By default, the systems sets the keyboard to US QWERTY. In case another keyboard layout is desired, this can be changed in the system settings menu. Refer to the Ubuntu manual for more information: <https://help.ubuntu.com/>

5.1.3 Connecting to a Network

The Jetson Nano features an Ethernet port for internet access.

5.1.4 Unlocking the System

Normally the system will automatically log in at boot. Enter the following credentials whenever a pop up dialog appears, the screen is locked or sudo is used in a terminal:

User: jetcis

Password: jetcis

5.2 JetCis GUI

5.2.1 Starting the GUI

Figure 6:
JetCis Viewer

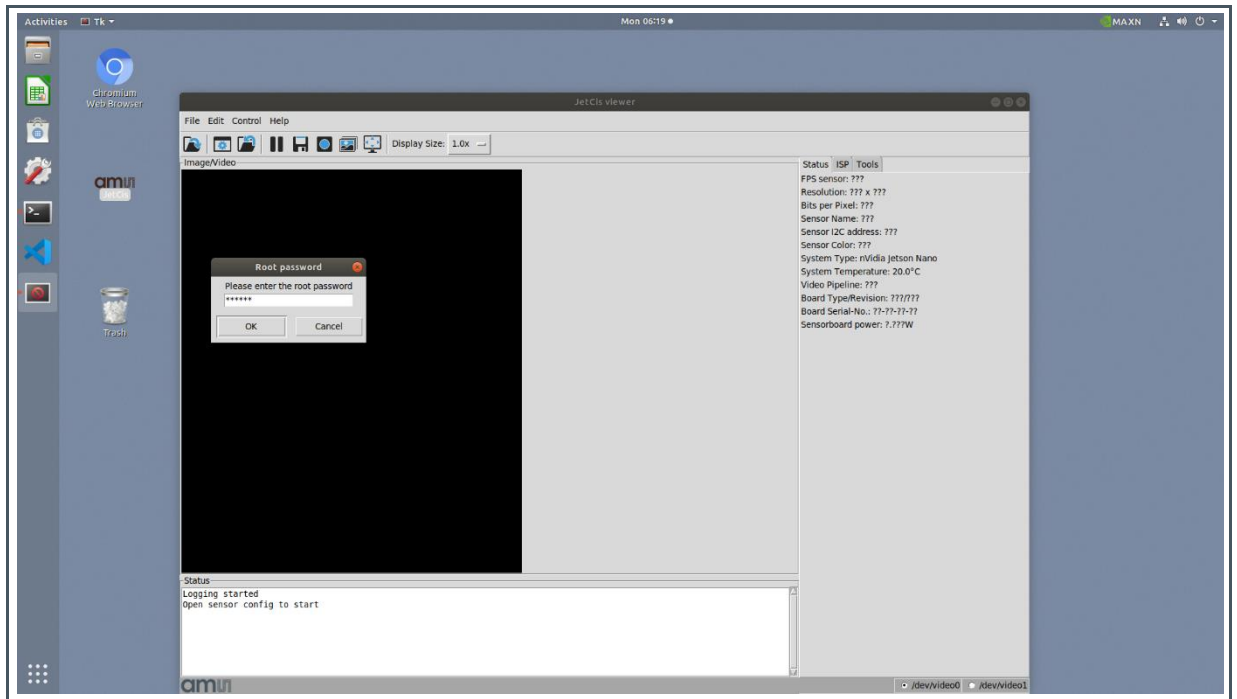

On the desktop, there is a shortcut called JetCisViewer.

- Double click the desktop icon to open the GUI software. There will appear a prompt to ask a password. Enter the default password ('jetcis').



Information

The GUI can be opened twice. This can be useful in situation where the user wants to stream images from two sensors simultaneously.

5.2.2 Select Video Source

- Select either video0 (default) or video1 in the bottom right corner of the GUI before proceeding to the next step.

5.2.3 Loading a Configuration File

The next step is to select the appropriate configuration file that matches the sensor board.

Now press File -> Open Sensor Configuration and select the desired configuration file in the directory ~/JetCis/sensor. Make sure the connected sensor board matches the configuration file. Click open to load all the registers and GUI configurations. When the register upload is finished, a live image will appear.

Figure 7:
Live Image

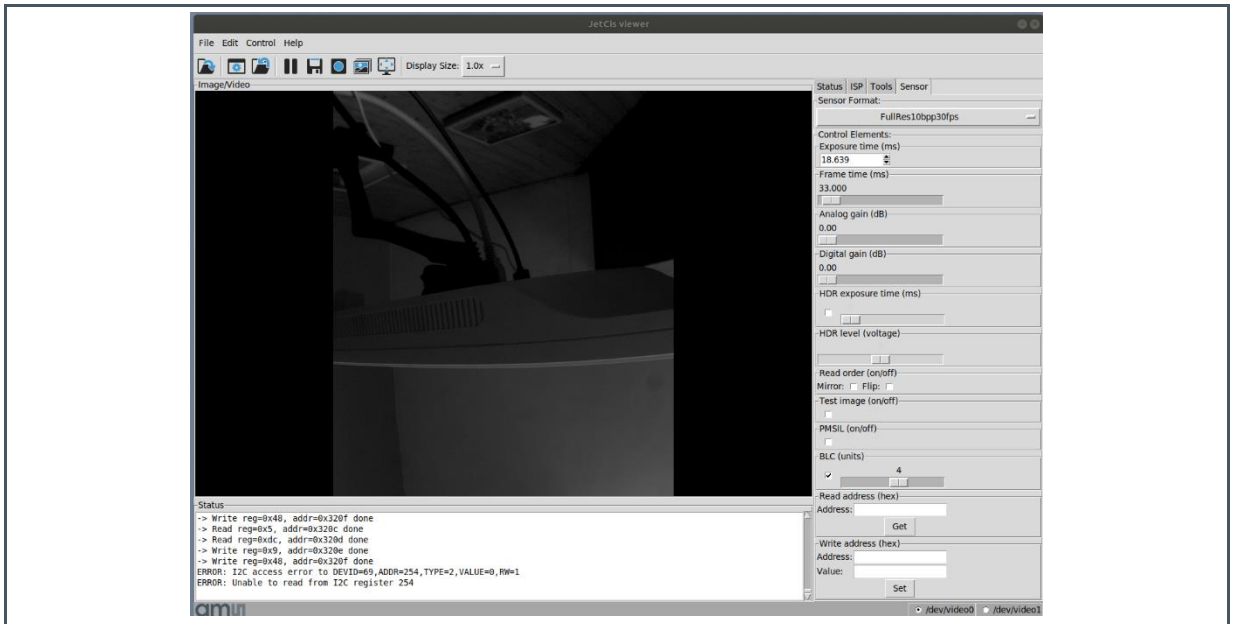

Information

The image shown in the live image has a gamma curve applied. When saving an image, the actual raw data is saved.

5.2.4 GUI Features

The GUI contains different features as seen in Figure 7. In this section, a detailed overview is given for each of the areas in the window.

Menu Bar

Figure 8:
Menu Bar

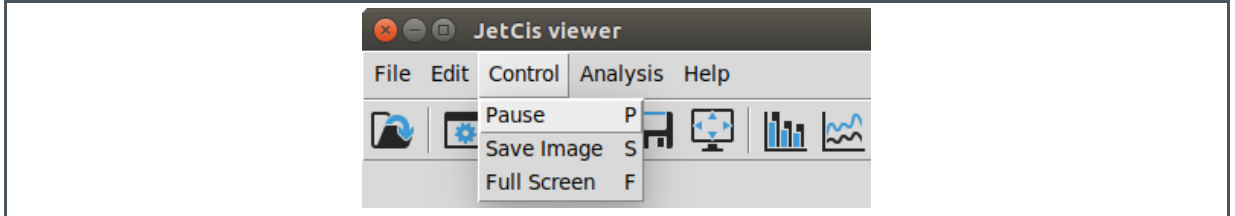

On top of the window, several actions can be selected by pressing the buttons in the menu bar. For some actions, a shortcut key exists. This is written on the right, e.g. F to toggle full screen.



Information

Documentation such as datasheets and schematics can be accessed from the help menu.

Toolbar

Figure 9:
Toolbar

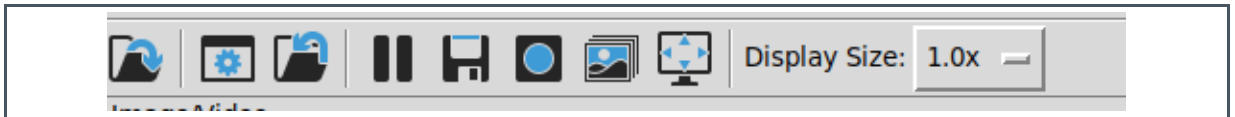

Below the menu bar, the toolbar is present. The meaning of the different icons are from left to right:

- Open a sensor configuration file (see tooltip when hovering the pointer)
- Save GUI settings
- Open GUI settings
- Play/pause the live stream
- Save the presented images as 16-bit raw TIFF
- Capture a video in 8-bit h264 compression
- Burst image capture as 16-bit raw TIFF
- Enable full screen
- Display size

Widgets

On the right of the window, widgets are shown. This contains four tabs:

- Status: sensor live information, see figure below
- ISP: image signal processing, see figure below
- Sensor: control to change sensor parameters, see Figure 7

Figure 10:
Status and ISP Tab

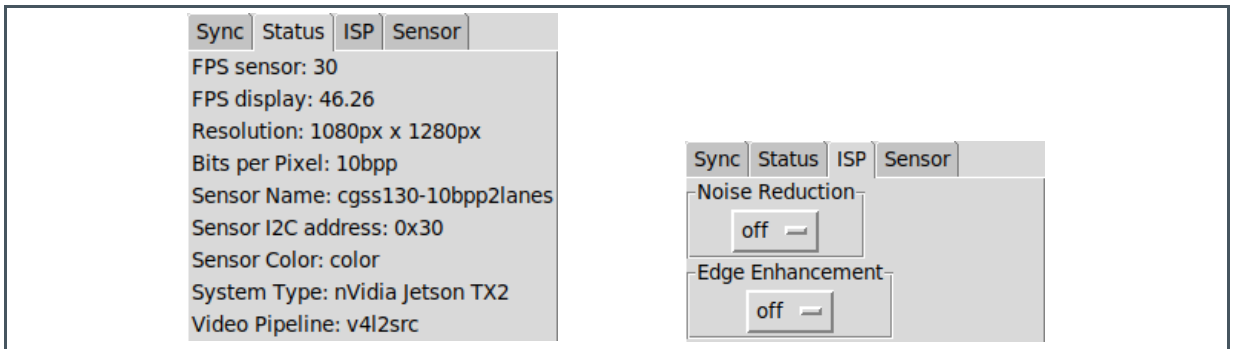

Waveform and Histogram

Figure 11:
Waveform and Histogram

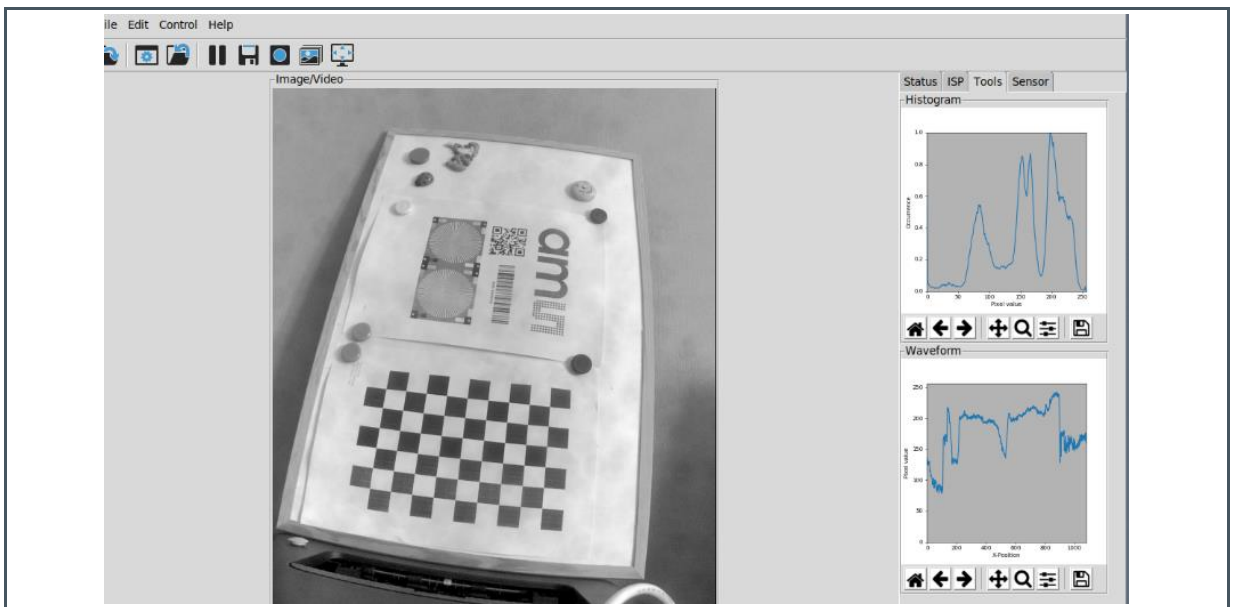

Two image analysis tool are implemented in the GUI. These are a histogram and a row/column profile of the image. This is illustrated in the figure below. The plots are a live view of the presented image and can be modified with the buttons on the bottom of the window. To zoom in on the image, go to the

main window again and scroll on the live image. Hence, the plot will be updated. Note that drawing the plot will reduce the framerate, so it is better to pause the image when displaying the histogram.

5.2.5 Read/Write Registers with the GUI

On the right side, it is possible to enter an address in the 'Read' section. Press GET or ENTER to readout the value from the register. The output will be shown in the Status window at the bottom.

To write a register, enter address and value in the appropriate fields. Press the SET or ENTER button to write. Note that all addresses and values should be written in a hexadecimal notation, for example, '3e09' can be entered.

Figure 12:
Read and Write Registers with the GUI

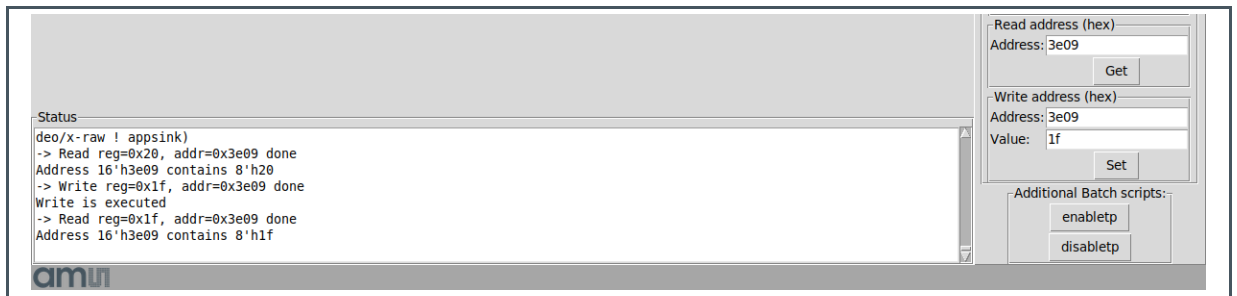

5.2.6 Save and View Images/Video

Figure 13:
Capturing Images Using the Toolbar Buttons.



- 1 Save picture (raw/tiff 16-bit)
- 2 Start/stop video capture (H.264)
- 3 Capture burst sequence (raw/tiff 16-bit)

Starting from version 2.1.7, images are saved as 16-bit TIFF. This means, when using the sensor in 12-bit mode, all pixel values are multiplied to scale to 16-bit TIFF values. There is also a burst capture functionality, which will capture a predefined amount of images. The number of images can be configured by modifying the file ~/JetCis/config.cfg.

Images can be opened with most image viewers.

To capture video, click the video icon. To stop recording, click it again.

5.2.7 Adding Widgets to the GUI (advanced users)

To automate a specific setting, a widget can be added to the GUI. To add a widget to the GUI, select first the directory specific to the sensor, for example: ~/JetCis/Mira130-10bpp2lanes where all the descriptions of the already present widgets are located. Here, select a random python file or one that contains settings which are close to what is desired. Copy and paste the file in the same directory and change the filename. This file will contain the functionality of the widget.

When the file is created, go to the directory ~/JetCis/sensor. Here, the configuration files of the sensors are stored. Open the file Mira130-10bpp2lanes.sensor with a text editor, e.g. Gedit or Vim. In this file, specify under [Control] the path of the python file made earlier to add the widget to the GUI.

Figure 14:
Add Python File to Configuration File

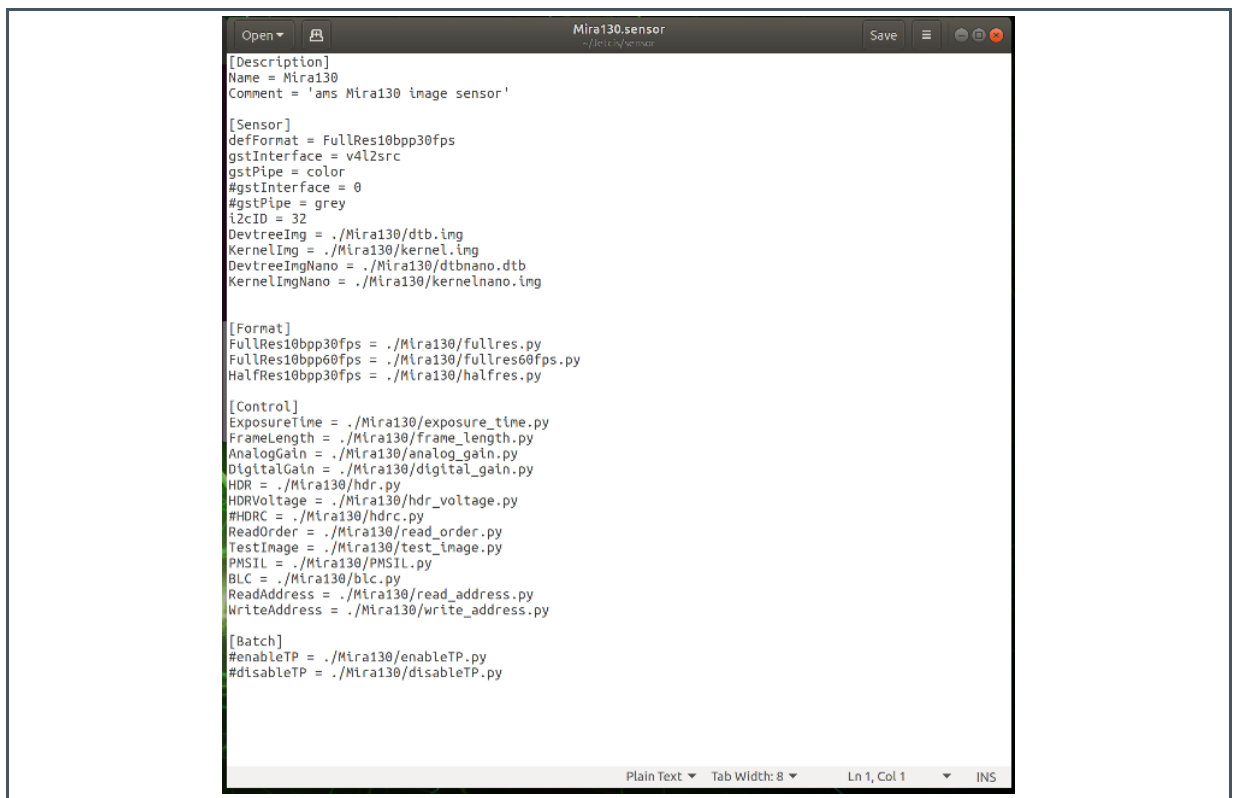

In the created python file, you need to have at least the function `controllnit()` and `controlSet()`. Those are normally present because a file was copied. In `controllnit()`, change the name and other settings. The types where you can choose from are `slider`, `list`, `checkboxbutton`, `text_entry_read`, `text_entry_write`, `checkboxbutton_and_slider` and `two_checkboxbuttons`. In `controlSet()`, specify what will happen when the widget is changed by e.g. moving a slider or pressing a button.

Figure 15:
Example Code of the Digital Gain Slider

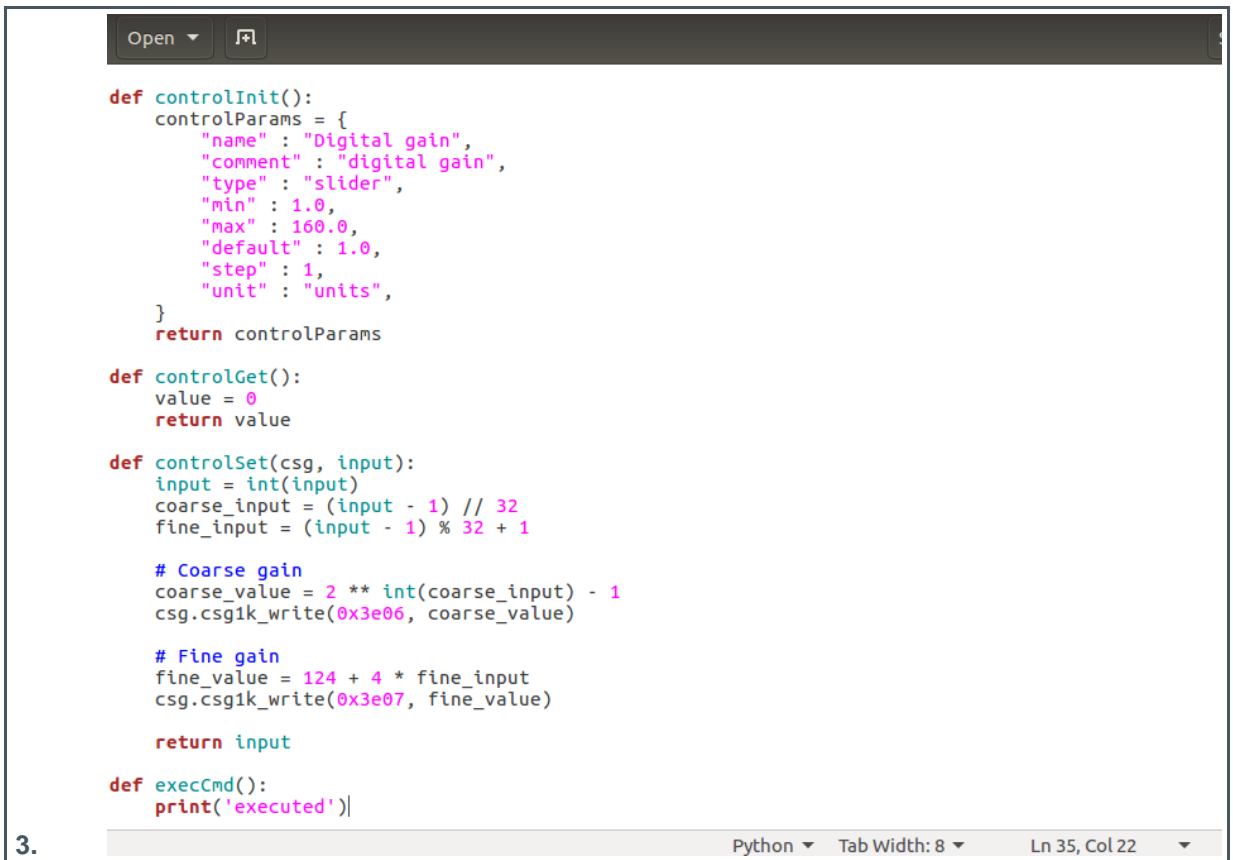

```
def controlInit():
    controlParams = {
        "name" : "Digital gain",
        "comment" : "digital gain",
        "type" : "slider",
        "min" : 1.0,
        "max" : 160.0,
        "default" : 1.0,
        "step" : 1,
        "unit" : "units",
    }
    return controlParams

def controlGet():
    value = 0
    return value

def controlSet(csg, input):
    input = int(input)
    coarse_input = (input - 1) // 32
    fine_input = (input - 1) % 32 + 1

    # Coarse gain
    coarse_value = 2 ** int(coarse_input) - 1
    csg.csg1k_write(0x3e06, coarse_value)

    # Fine gain
    fine_value = 124 + 4 * fine_input
    csg.csg1k_write(0x3e07, fine_value)

    return input

def execCmd():
    print('executed')
```

3. Python Tab Width: 8 Ln 35, Col 22

5.3 Python Scripting, API and More

Besides the GUI, there is another possibility to interface with the camera board. In the folder `~/JetCis/scripting` the user can find multiple example python script to directly interface with the camera.

To edit and run the python scripts, an editor such as VS Code can be installed on the Jetson Nano. The default installed text editor 'Gedit' can also be used to edit the python files. As an alternative, the scripts can be run from the command line.

To run one of the scripts:

1. Make sure the GUI is closed
2. Open a terminal from the folder containing the script (right click -> new terminal)
3. Execute the following command, and the python script will be executed:
`python3 example_file.py`
4. Or for help, enter to see command line arguments:
`python3 example_file.py --help`
5. Some scripts support arguments, so you can run e.g.:
`python3 dual_cam.py -e 5 -d 0 1`
this script will open a live view with 2 cameras connected and exposure of 5 ms

For more information or feature requests, contact your **ams** application support person.

5.4 Shutting Down the System

Figure 16:
Shut Down Screen

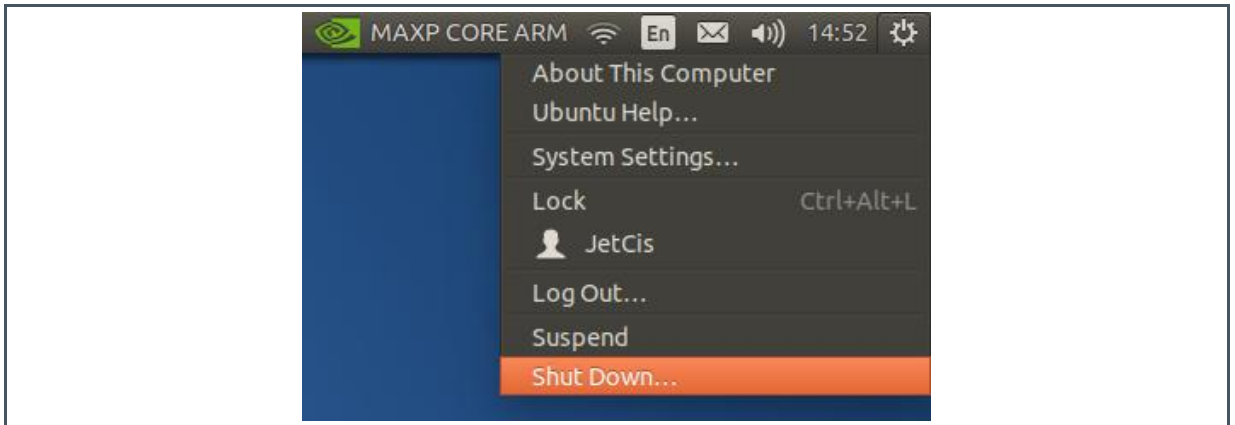

Click the top right icon in the status bar, and click shutdown. The system will turn off. Now it is safe to plug or unplug the sensor boards.

6 Transferring Data to Another Computer

Using the free application WinSCP, one can copy files between a JetCis kit and a Windows computer.

1. Make sure the JetCis is connected to the internet.
2. Then, find its ip address by running ifconfig in a terminal.
3. On the Windows computer, create a new session in WinSCP. Choose for SFTP protocol, enter the credentials and press Login.
4. You can then browse files on the JetCis and drag and drop to copy files to your Windows PC.

Figure 17:
WinSCP

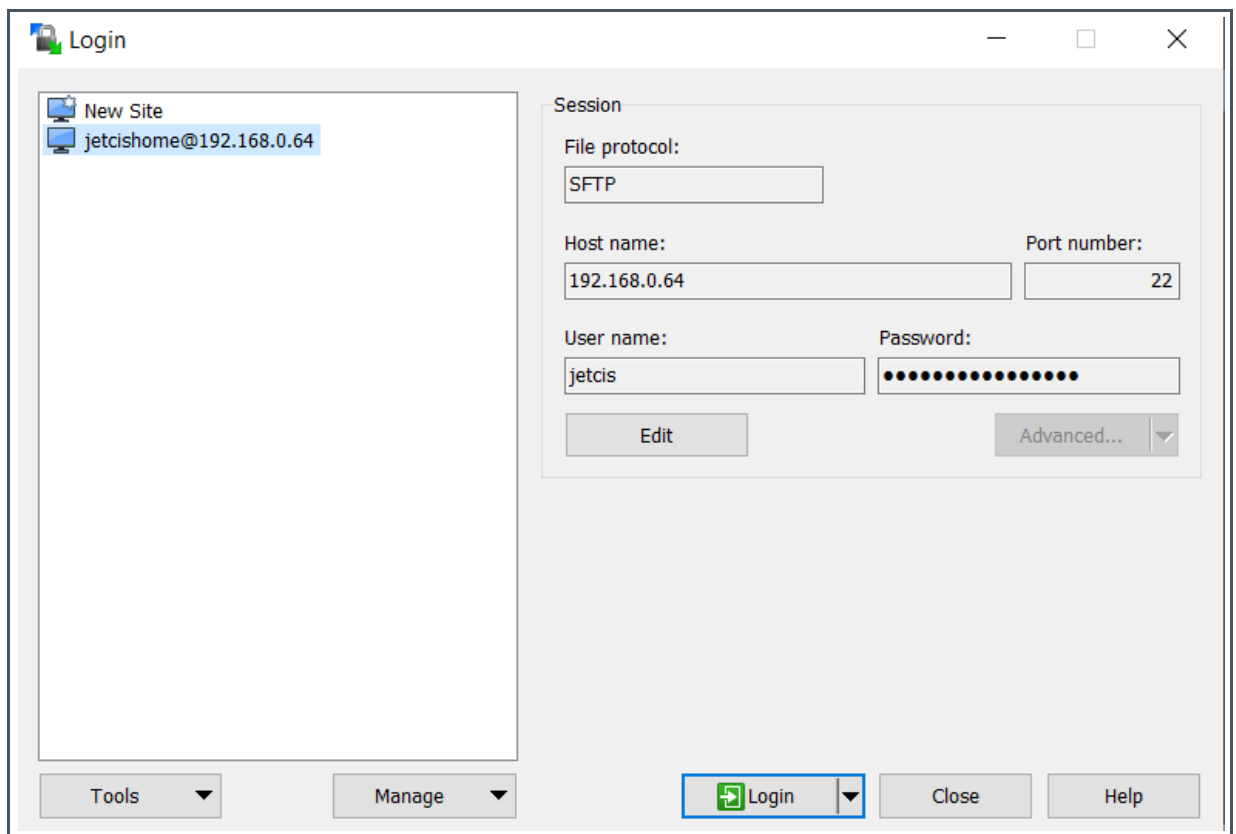

7 Updating the Software

7.1 Updating the GUI Software

Contact your **ams** Application Support team for information on how to update the GUI software. They will provide you with further instructions. Note: an internet connection is advised when updating the kit.

Checkout <https://ams.com/download-center> for updates or contact your application engineer.

The update procedure typically goes as follows:

1. Download the zip file from the link above
2. Copy the zip file to the downloads folder of the NVidia Jetson Nano
3. Right click the zip folder, and press 'open with Archive manager'
4. Click Extract
5. Go to the folder called ShellInstaller
6. Right click in this folder and click Open in Terminal
7. Enter the command: "**sudo chmod +x install.sh**"
8. Enter the command: "**./install.sh**"
9. Open the GUI via the desktop shortcut