

Up to 400 A Class J ferrule and knifeblade power distribution fuse blocks



30 and 60 amp modular ferrule blocks.



100, 200 and 400 amp modular knifeblade blocks.

Catalog symbols:

- JM60030-_MW_
- JM60060-_MW_
- JM60100-_MW_
- JM60200-_MW_
- JM60400-_MW_

Description:

Bussmann® series Class J fuse block features power distribution capability.

This patented design simplifies panel layouts and uses up to 65 percent less panel space. Additionally, it lowers inventory costs while reducing installation time and labor by an average of 33 percent.

Furthermore, this design uses fewer wire connections, reducing watts loss and overall operating temperature of the panel.

Features and benefits:

- Combination power distribution block and fuse block reduces wire connections and total panel components, using up to 65 percent less panel space and reducing installation time and labor by an average of 33 percent when compared with traditional fuse block/power distribution block solutions.
- A 200,000 amp withstand rating helps achieve a higher assembly short-circuit current rating (SCCR) for compliance with NEC® sections 110.10, 409.110(4), 409.22, 440.4(B), 670.3(A)(4) and 670.5.
- Optional see-through cover enhances safety with IP20 finger-safe protection, lockout/tagout capability and open circuit indication.
- Available in 1-, 2- and 3-pole configurations to meet stocking requirements.
- To reduce inventory, assembly time and labor, modular single-pole blocks snap-together for tool-less assembly of multiple poles at point of use.
- Blocks rated up to 60 amps feature DIN-Rail and panel mount versatility, which allows one product to be used for multiple applications without incurring additional inventory cost.

Specifications:

Fuse class

- Class J

Ratings

- Volts: 600 V
- Amps: up to 400 A
- Withstand rating (SCCR): 200 kA Sym RMS

Agency information

- Blocks:
 - UL® Listed E14853 – IZLT
 - CSA® Certified 47235 — 6225-01
- Covers: UL Listed UL E58836 – JDVS
- RoHS compliant

Poles

- 1-, 2-, 3-pole

Mounting

- 30 and 60 amp blocks DIN-Rail and panel mount
- 100, 200 and 400 amp blocks panel mount only

Flammability ratings

- Blocks: UL 94V0, self-extinguishing
- Covers: UL 94HB, self-extinguishing

Operating and storage temperature range

- Blocks: -40°C to +120°C
- Covers:
 - Non-indicating -40°C to +120°C
 - Indicating -20°C to +90°C

Materials

- Base: Thermoplastic
- Terminals: Tin-plated aluminum

Conductors

- 75°C/90°C Cu/Al (unless otherwise noted)

Accessories:

- Optional IP20 finger-safe covers in indicating and non-indicating versions. Order one for each pole.
- Universal marker labels for 30 and 60 amp blocks, Bussmann series catalog number TM26CB.
- DIN-Rail end stops for blocks rated up to 60 A, Bussmann series catalog numbers BRKT-ND or BRKT-NDSCRW2.

Recommended fuses (order separately)

Description	Amps	Data sheet no.
Ultimate protection Low-Peak™ LPJ time-delay fuses	up to 60	1006
	70 to 600	1007
Advanced protection Limitron™ JKS fast-acting fuses	up to 60	1026
	70 to 600	1027
High speed Class J DFJ drive fuses	up to 600	1048

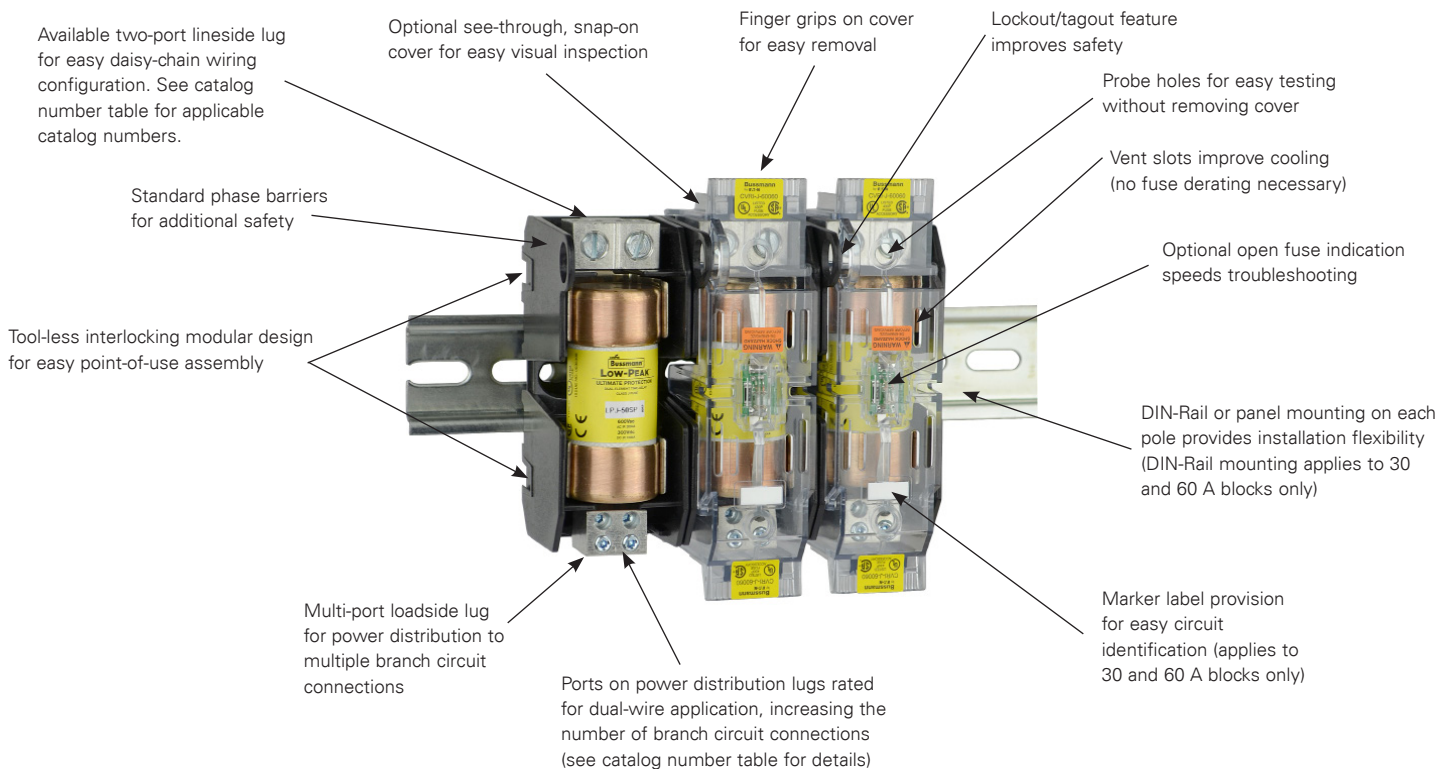

Catalog numbers:

Catalog no.	Optional covers*	Fuse amp range	Lineside (conductors per port)				Loadside (conductors per port)				
			Poles	Conductors	Ports/pole	Torque AWG	N·m (lb-in)	Conductors	Ports/pole	Torque AWG	N·m (lb-in)
JM60030-1MW14	N/A	up to 30	1			2-3	5.6 (50)			Cu (1) 8	3.4 (30)
JM60030-2MW14			2	Cu 2-14 Al 2-8	1	4-6	5.1 (45)	4	Cu (1) 8-14 Cu (2) 12-14****	Cu (1) 10-14	2.8 (25)
JM60030-3MW14			3			8	4.5 (40)		Al (1) 8 Str Al (1) 10 Sol	Cu (2) 12-14	3.4 (30)
JM60060-1MW12†			1			2-4	5.6 (50)			2-3	5.6 (50)
JM60060-2MW12†			2	Cu 2-14 Al 2-8	2	6-10	4.5 (40)	1	Cu 2-14 Al 2-8	4-6	5.1 (45)
JM60060-3MW12†			3			12-14	1.7 (15)			8	4.5 (40)
JM60060-1MW14†			1			2-3	5.6 (50)			Cu (1) 8	3.4 (30)
JM60060-2MW14†	CVR-J-60060 CVRI-J-60060**	35 - 60	2	Cu 2-14 Al 2-8	1	4-6	5.1 (45)	4	Cu (1) 8-14 Cu (2) 12-14**** Al (1) 8 Str Al (1) 10 Sol	Cu (1) 10-14	2.8 (25)
JM60060-3MW14†			3			8	4.5 (40)			Cu (2) 12-14	3.4 (30)
JM60060-1MW24			1			2-4	5.6 (50)			Cu (1) 8	3.4 (30)
JM60060-2MW24			2	Cu 2-14 Al 2-8	2	6-10	4.5 (40)	4	Cu (1) 8-14 Cu (2) 12-14**** Al (1) 8 Str Al (1) 10 Sol	Cu (1) 10-14	2.8 (25)
JM60060-3MW24			3			12-14	1.7 (15)			Cu (2) 12-14	3.4 (30)
JM60100-1MW14			1			1/0-3; Cu (2) 4-6	5.6 (50)			4-6	4.0 (35)
JM60100-2MW14	CVR-J-60100-M CVRI-J-60100-M**	70 - 100	2	Cu 1/0-14 Al 1/0-12	1	4-6; Cu (2) 8	5.0 (45)	4	Cu (1) 4-14 Al (1) 4-8 Cu (2) 10-14****	8	2.8 (25)
JM60100-3MW14			3			8; Cu (2) 10-14	4.5 (40)			Cu (2) 10-14****	Cu 10-14
JM60200-1MW16			1			250kcmil-1	42 (375)			4-6	4.0 (35)
JM60200-2MW16	CVR-J-60200-M CVRI-J-60200-M**	110-200	2	Cu/Al (1) 250kcmil-6 Cu (2) 2-6	1			6	Cu (1) 4-14 Al (1) 4-8 Cu (2) 10-14****	8	2.8 (25)
JM60200-3MW16			3			2-6	31 (275)			Cu (2) 10-14****	10-14
JM60400-1MW16			1			600kcmil	57 (500)			2-3	5.6 (50)
JM60400-2MW16			2							4-6	5.0 (45)
JM60400-3MW16	CVR-J-60400-M CVRI-J-60400-M**	225-400		Cu/Al (1) 600kcmil-4 Cu/Al (2) 3/0-4	1	500kcmil-4	51 (450)	6	Cu (1) 2-14 Al (1) 2-8 Cu (2) 8-14****	8	4.5 (40)
			3			Cu (2) 3/0-4 Al (2) (3/0-4)	57 (500)			10-14	4.0 (35)
JM60400-1MW26			1							2-3	5.6 (50)
JM60400-2MW26			2			350kcmil-1	42 (375)			4-6	5.0 (45)
JM60400-3MW26			3	Cu/Al 350kcmil-6	2			6	Cu (1) 2-14 Al (1) 2-8 Cu (2) 8-14****	8	4.5 (40)
						2-6	31 (275)			10-14	4.0 (35)
										(2) 10-14	4.5 (40)

* Order one cover per pole.
 ** With open fuse indication. 90 V minimum and closed circuit required for illumination.
 *** Dual wire rated lugs with same wire size and stranding.
 † Rated for 75°C Cu/Al conductors. Conductors with higher ratings may be used with appropriate derating.

30 A dimensions — mm (in)

Catalog nos. JM60030-(poles)MW14 — One port in, four ports out (covers not available)

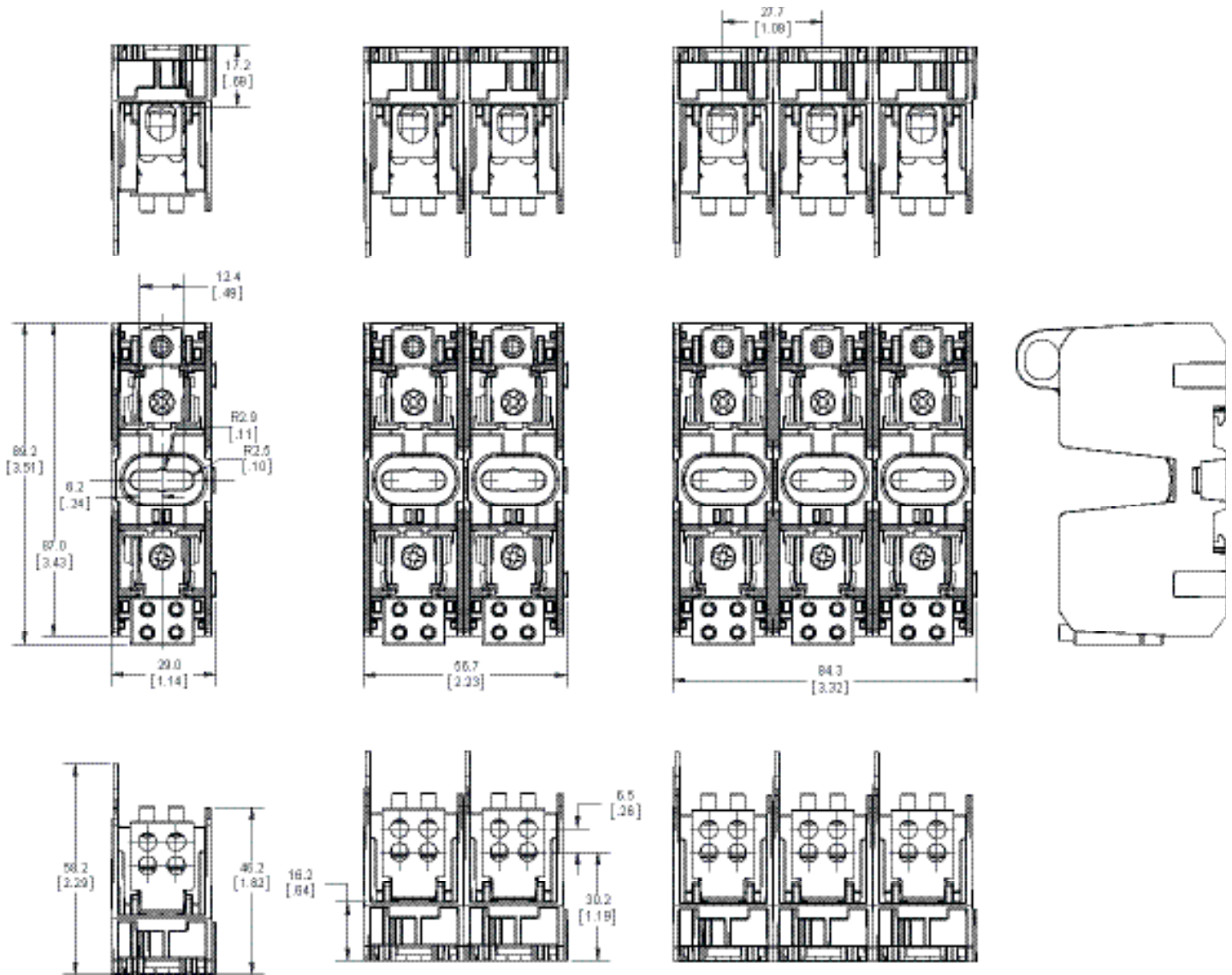

60 A dimensions — mm (in)

Catalog nos. JM60060-(poles)MW12 — Two ports in, one port out

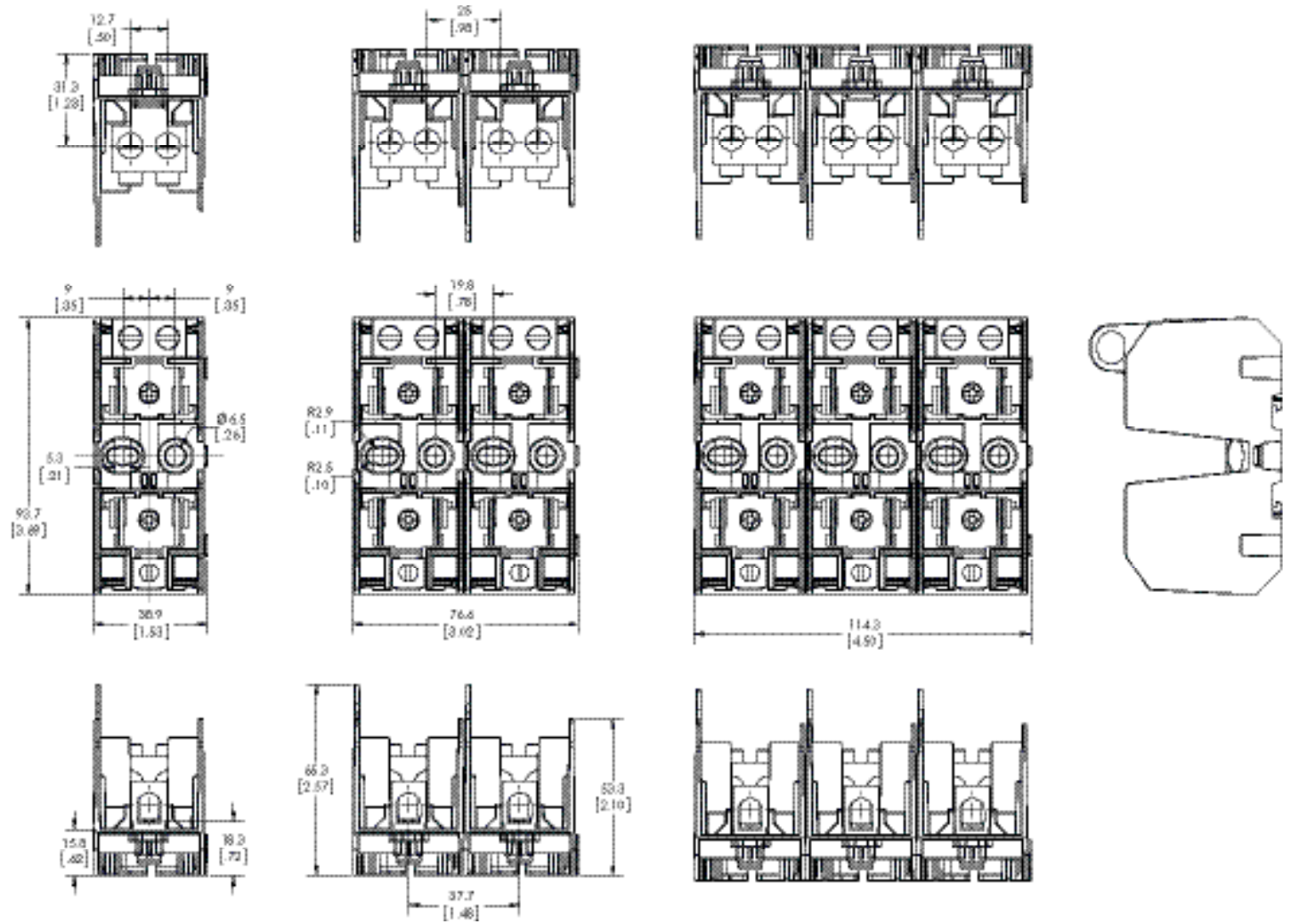

With optional cover, see catalog number table on page three for available versions

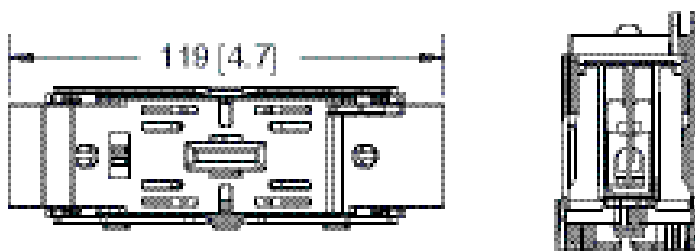

60 A dimensions — mm (in)

Catalog nos. JM60060-(poles)MW14 — One port in, four ports out

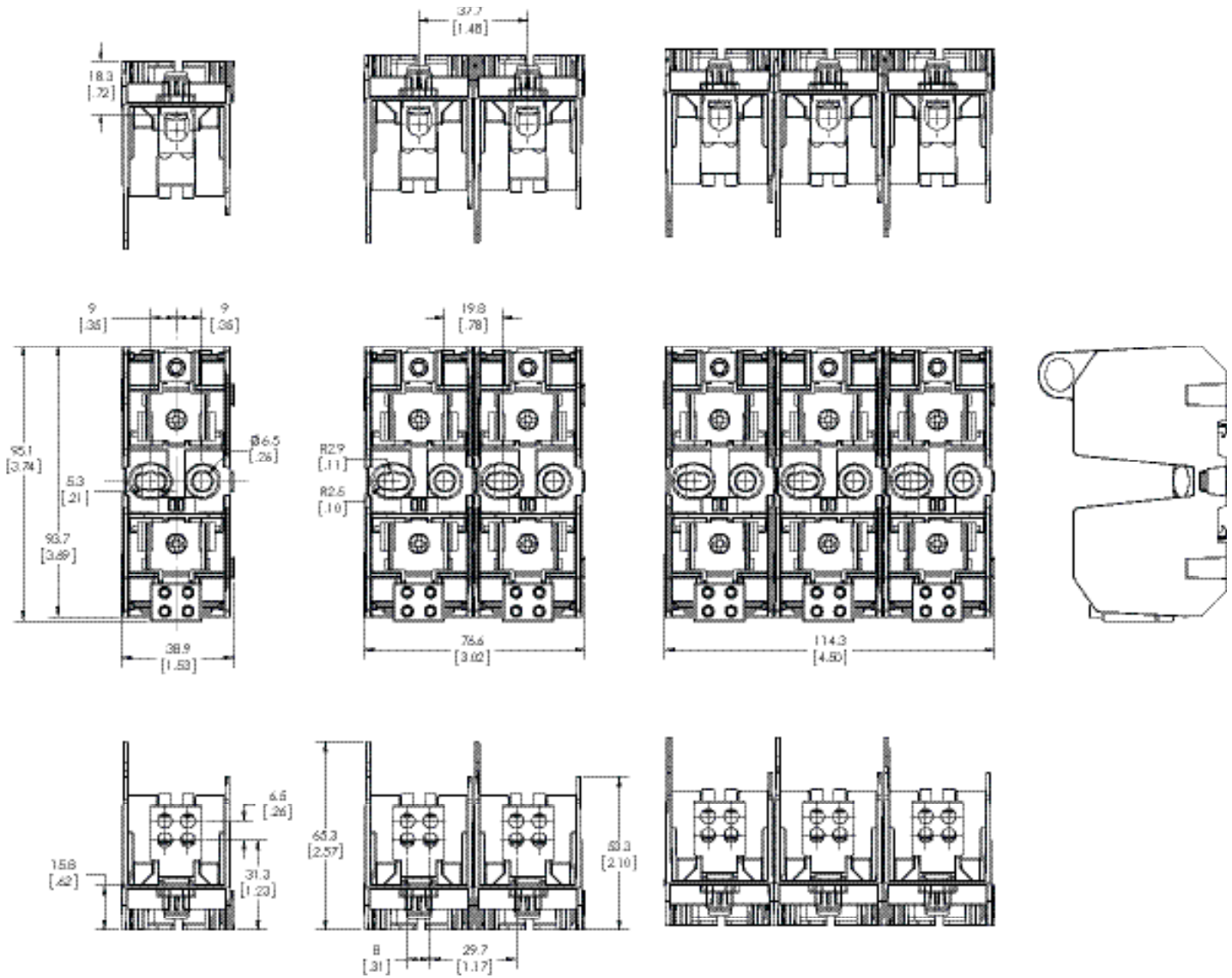

With optional cover, see catalog number table on page three for available versions

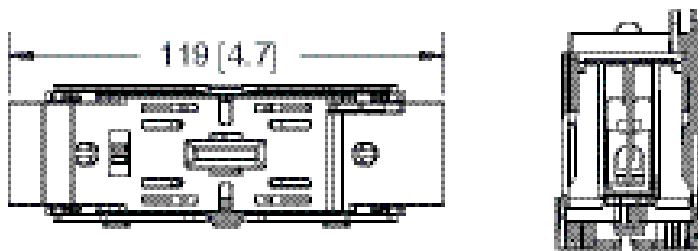

60 A dimensions — mm (in)

Catalog nos. JM60060-(poles)MW24 — Two ports in, four ports out

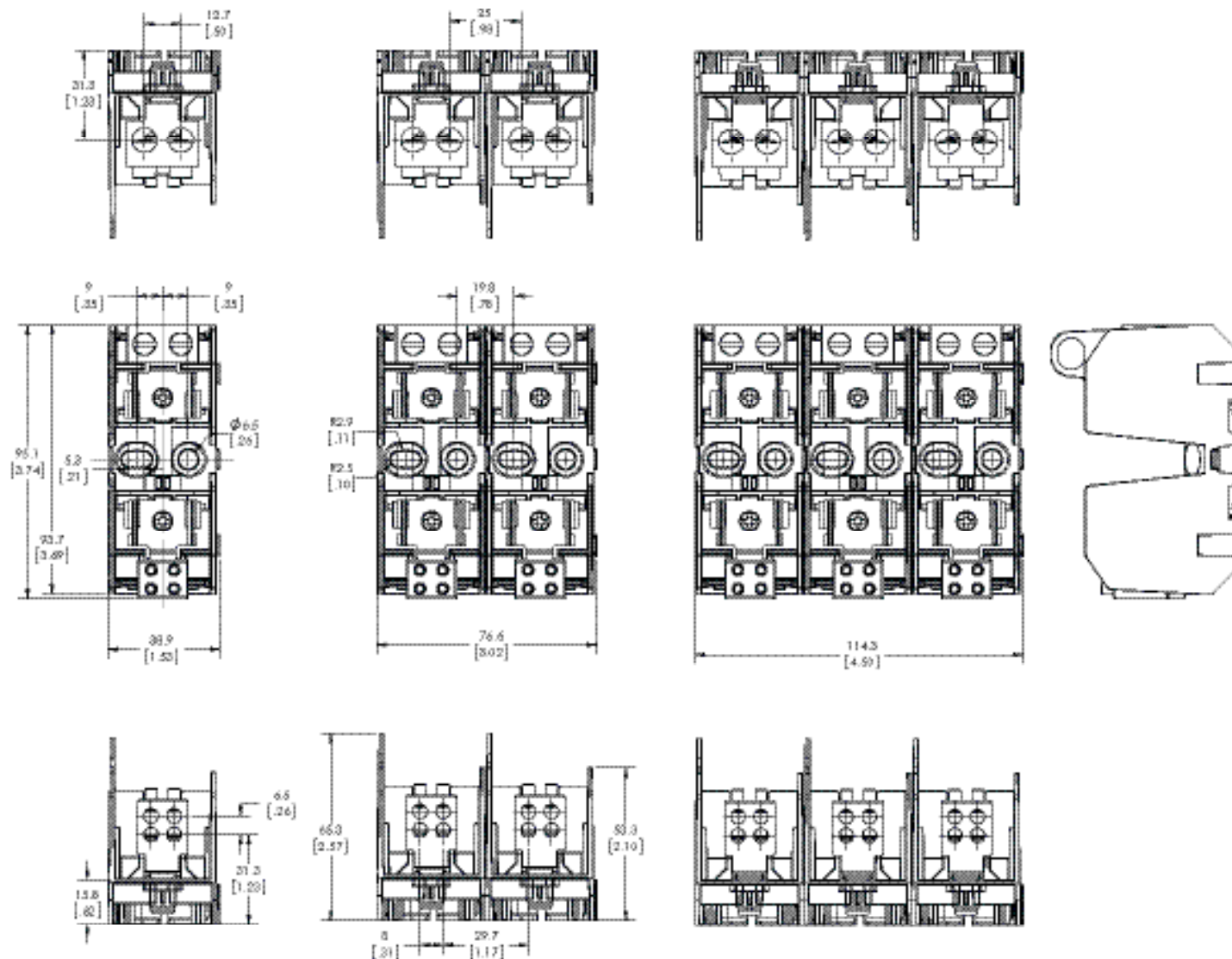

With optional cover, see catalog number table on page three for available versions

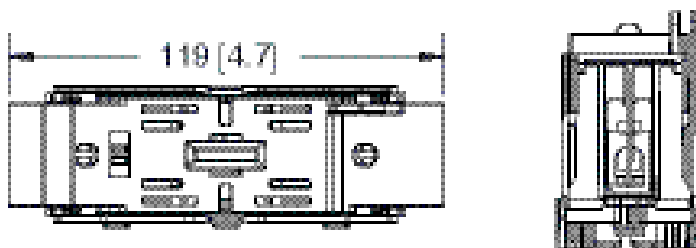

100, 200 and 400 A dimensions — mm (in)

Catalog nos. JM60100-(poles)MW14 (100 A), JM60200-(poles)MW16 (200 A) and JM60400-(poles)MW16/26 (400 A)

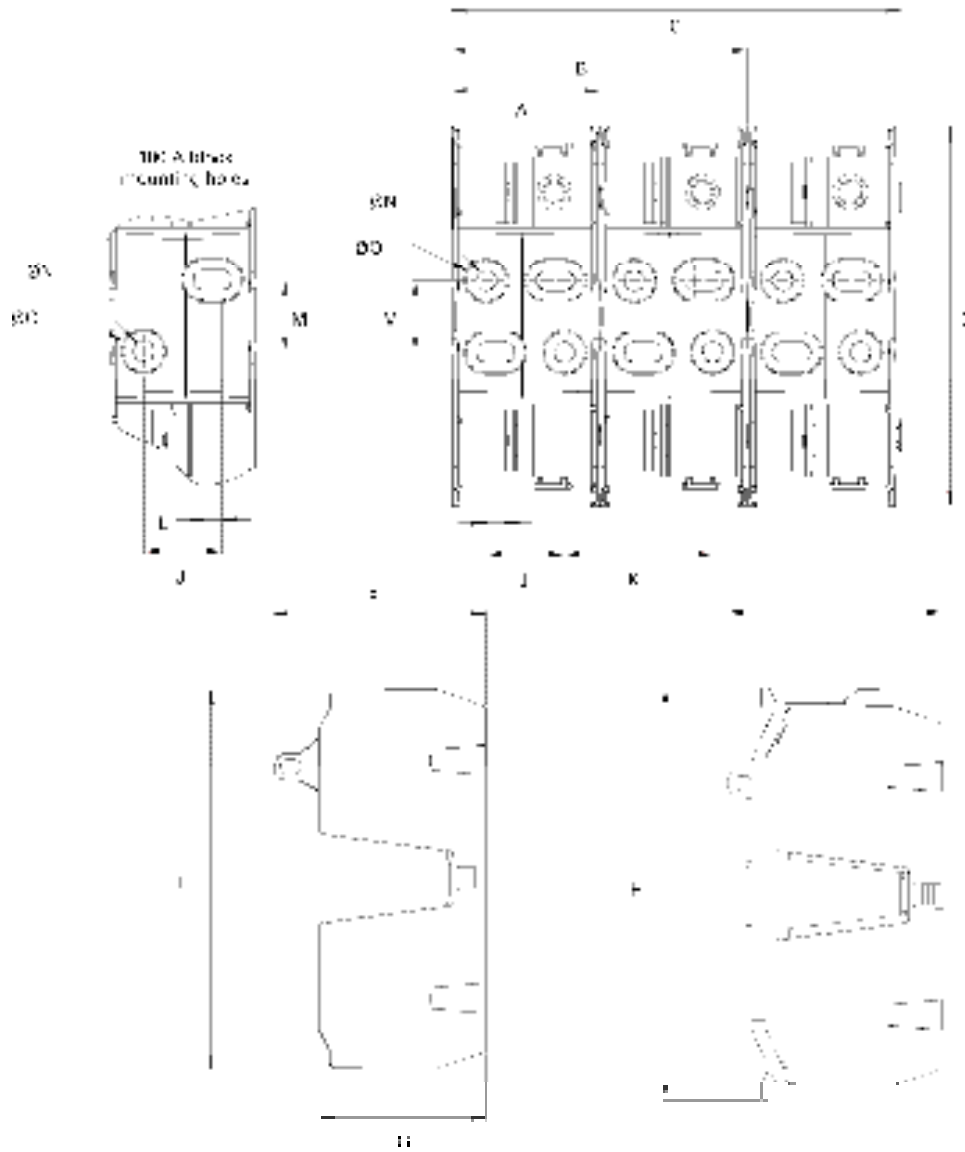

Block size		A	B	C	D	E	F	G	H	I	J	K	L	M	ØN	ØO
100 A	in	2.0	4.0	6.0	5.5	5.5	2.8	2.2	6.0	2.8	0.9	2.0	0.4	1.1	0.4	0.5
	mm	51	102	153	139	139	72	55	152	72	22	51	10	29	9	13
200 A	in	2.6	5.3	8.0	6.8	6.8	3.8	3.0	7.3	3.8	1.4	2.6	0.3	1.3	0.4	0.7
	mm	67	134	203	172	172	97	75	186	97	35	67	8	32	9	19
400 A	in	3.5	7.0	10.6	8.0	8.0	4.8	4.1	8.7	4.8	2.0	3.5	0.3	1.6	0.4	0.7
	mm	88	177	268	202	202	121	105	220	121	50	88	8	41	9	19