

PT-6

6-mm carbon through-hole trimmer potentiometer

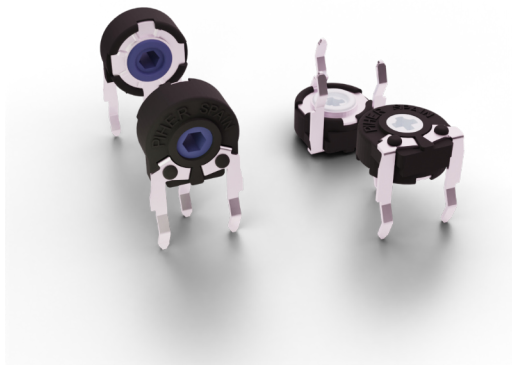

KEY FEATURES

- ▶ Excellent performance
- ▶ Carbon resistive element
- ▶ Up to 10 mechanical detents
- ▶ Up to 10.000 life cycles
- ▶ IP54 protection
- ▶ Magazines packaging for automatic insertion
- ▶ Polyester substrate
- ▶ Wiper positioned at initial, 50% or fully clockwise
- ▶ Loose and assembled shaft and knobs
- ▶ Linear, logarithmic and antilogarithmic tapers
- ▶ SPDT switch function

On request

- ▶ Embossed tape packaging

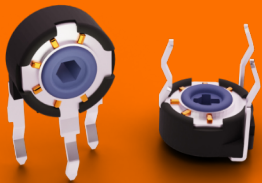

The **only 6 mm miniature trimmer**
potentiometer with optional
stop positions for haptic feedback.

ELECTRICAL SPECIFICATIONS

Taper*	Lin, Log, Alog
Range of values*	[Decad. 1.0 - 2.0 - 2.2 - 2.5 - 4.7 - 5.0]
Lin	220Ω ≤ Rn ≤ 5MΩ
Log, Alog	1KΩ ≤ Rn ≤ 5MΩ
Tolerance*	
220Ω ≤ Rn ≤ 1MΩ	± 20%
1MΩ < Rn ≤ 5MΩ	± 30%
Max. Voltage	
Lin	100 VDC
Log, Alog	50 VDC
Nominal power 50°C (122°F)	
Lin	0.1 W
Log, Alog	0.05 W
Residual resistance	≤ 0.5% Rn (5Ω min.)
Equivalent noise resistance	≤ 3% Rn (3Ω min.)
Operating temperature **	-25°C to +70°C (-13°F to + 158°F)

* Others available on request ** Up to 85°C depending on application.

APPLICATIONS

- ▶ Appliance program selection
- ▶ Thermostat adjustment
- ▶ Timer and control relays
- ▶ Consumer electronics
- ▶ Power tool controls
- ▶ Test and measurement equipment

PT-6

6-mm carbon through-hole trimmer potentiometer

MECHANICAL SPECIFICATIONS

Mechanical rotation angle	235° ± 5°
Electrical rotation angle*	200° ± 20°
Torque Rotational Stop	0.2 to 2 Ncm (0.3 to 2.7 in-oz) > 4 Ncm (>7 in-oz)
Life**	up to 10.000 cycles

*Increased rotational angle of 215°± 20° available upon request ** Others available on request

ENVIRONMENTAL TESTING

	Test conditions (CEI 393-1)	ΔR(%) - Typical test results
Electrical life	1.000h at 50°C; 0.1 W	±5%
Mechanical life	1000 cycles at 10 to 15 cpm	±3% (Rn < 1M)
Temperature coefficient	-25° C; +70° C	±300 ppm/°C C (Rn < 100K)
Thermal cycling	16h at 85°C and 2h at -25°C	±2.5%
Damp heat	500h at 40°C and 95% relative humidity (RH)	±5%
Vibration	2h each plane at 10Hz - 55Hz	±2%
Storage	6 month at 23°C ±2°C and 50% RH	±2.5%

Out of range values may not comply with these results. Standard test conditions: temperature: 23°C ±2°C and 45% to 70% RH. Mechanical life of detented versions is 100 cycles

RECOMMENDED CONNECTIONS

Recommended connection circuit for a position sensor or control application (voltage divider circuit electronic design).

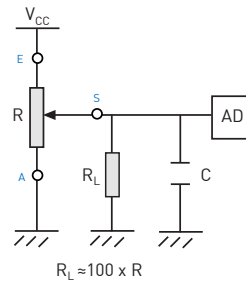

POWER RATING CURVE

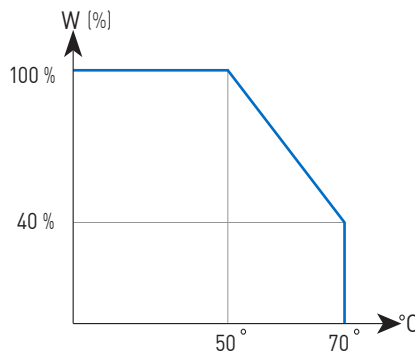

PT-6

6-mm carbon through-hole trimmer potentiometer

HOW TO ORDER

Example: PT6KV-221A2020

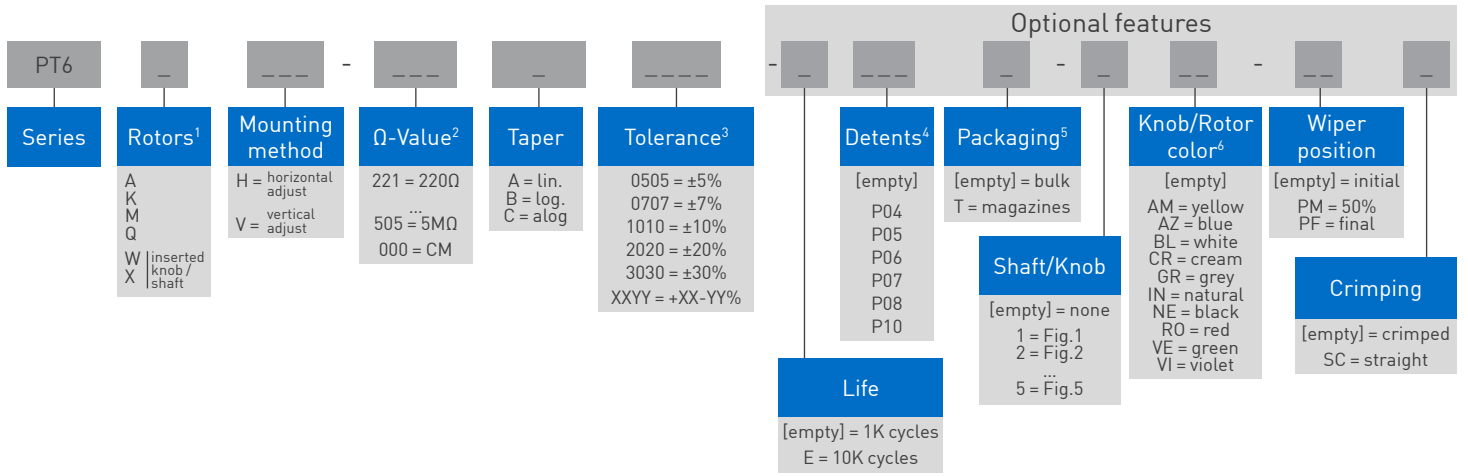

1. Rotors: "X" rotor only available on "H"-mounting versions.
2. Ω- Value: XXX - First two digits of Ω-value 000 = CM = switch SPDT version
XXX - Number of zeros
3. Tolerance: for custom tolerance please check availability: info@piher.net
4. Detents: Detented versions use purple rotor color (rotor color code "VI"). Ordering code example: PT6KH-254A2020-P04-VI
5. Packaging: Only for "V" mounting method. "W" rotor with shaft Fig. 2 is not available in magazines. Embossed tape packaging on request.
6. Without knob or shaft: only the rotor. With knob or shaft: only the knob/shaft. Default colour for knob/shaft is cream

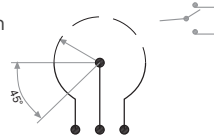

STANDARD CONFIGURATION

PT-6	
Life	1.000 cycles (forth and back the mechanical angle travel)
Detents	none
Housing color	black
Rotor color	white
Wiper Position	initial
Packaging	bulk

ORDER CODE EXAMPLES

PT6WV-104A1010-5NE-SC

6mm potentiometer with factory pre-inserted knob, V mounting method (vertical adjustment), 100K resistive value, linear taper, 10% resistive tolerance, black knob ref. 6148 and straight terminals (not crimped).

PT6KH-103A2020

6mm potentiometer with rotor "K" (cross shape), H mounting method (horizontal adjustment), 10K resistive value, linear taper, 20% resistive tolerance and crimped terminals.

PT-6

6-mm carbon through-hole trimmer potentiometer

ROTORS

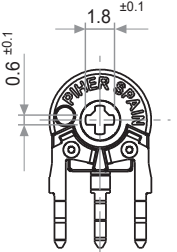
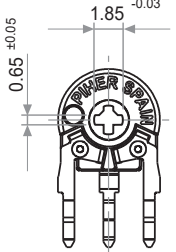
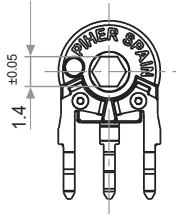
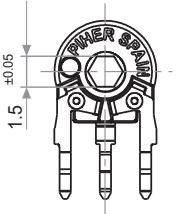
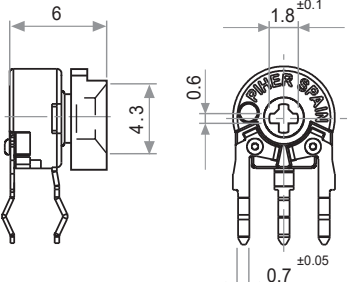
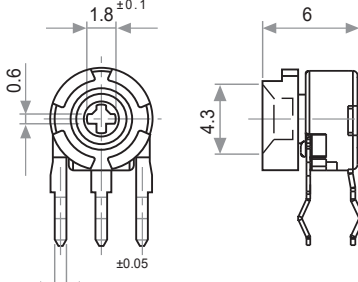
K Cross slot through hole	Q Cross slot through hole colour: pink	M Hexagonal through hole	A Hexagonal through hole colour: pink
			
X Adjustable from collector side		W Adjustable from terminal side	
 <p>With inserted knob / shaft. Example with knob ref. 5155</p>		 <p>With inserted knob / shaft. Example with knob ref. 5155</p>	

Default delivery is at initial position. Wipers are shown positioned at 50% for the picture.

MOUNTING METHOD

V = Vertical Adjustment - Horizontal Mounting

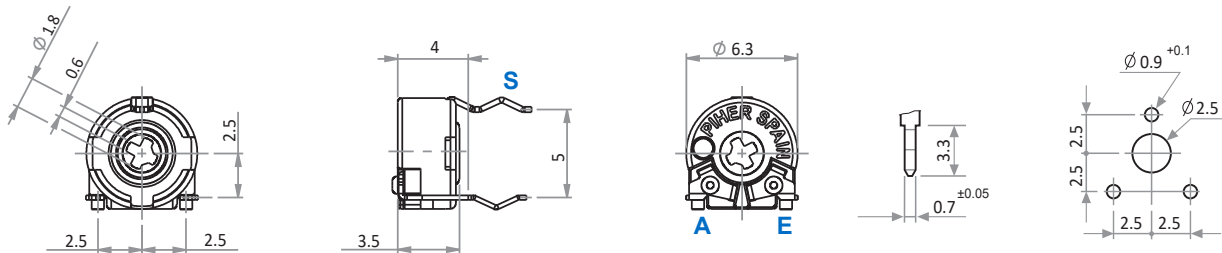

H = Horizontal Adjustment - Vertical Mounting

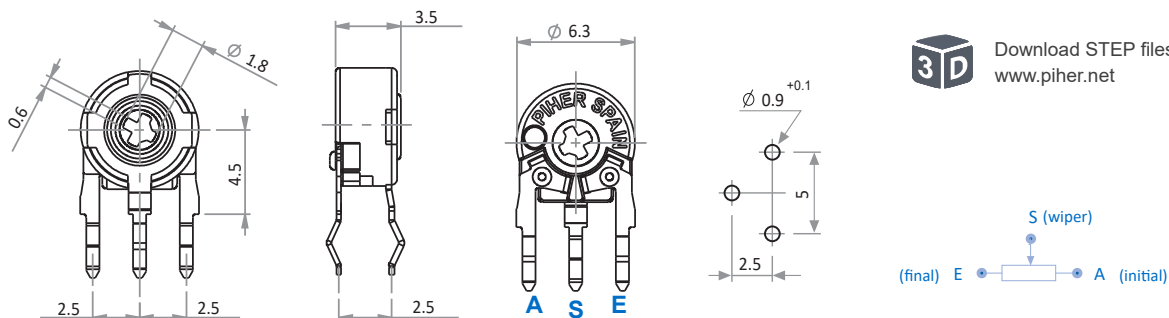

PT-6

6-mm carbon through-hole trimmer potentiometer

CRIMPING

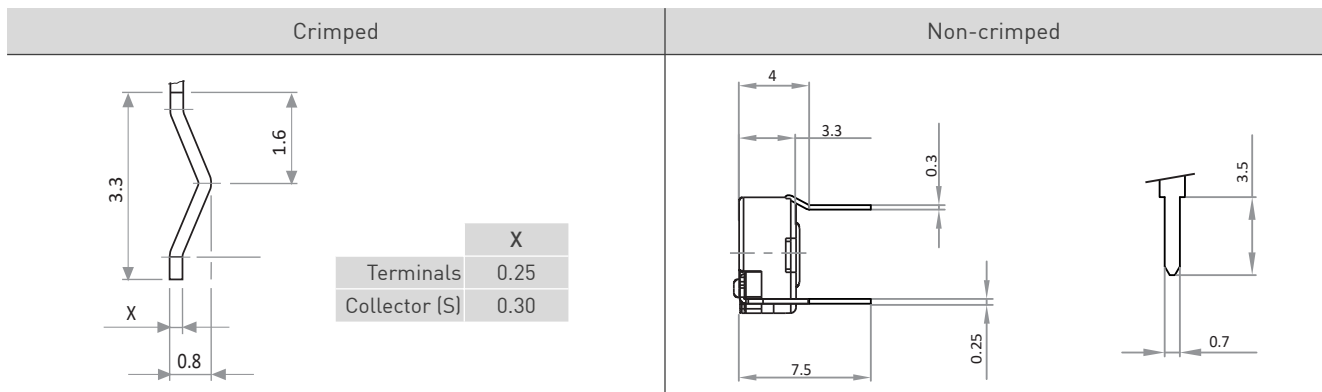

SMD MOUNTING AVAILABLE

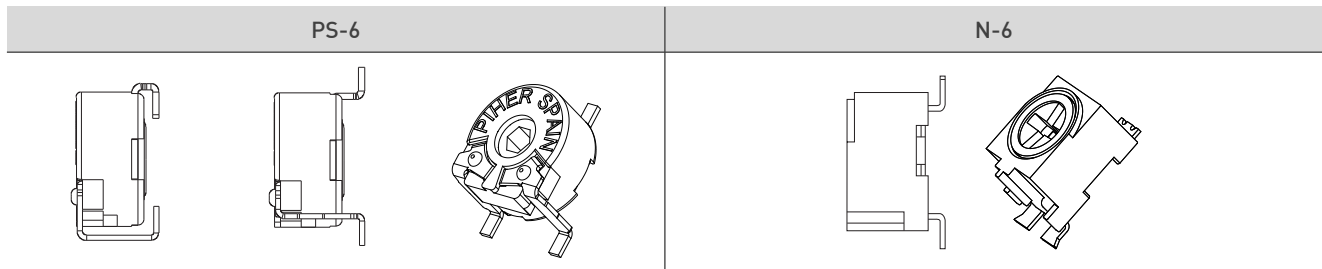

For more information visit: www.piher.net

STANDARD RESISTANCE-VALUES AND TOLERANCES

Resistance Ω	100	200	220	250	470	500	1K	2K	2.2K	2.5K	4.7K	5K	10K	20K	22K	25K	47K	50K	100K	200K	220K	250K	470K	500K	1M	2M	2.5M	4.7M	5M
Order Code	101	201	221	251	471	501	102	202	222	252	472	502	103	203	223	253	473	503	104	204	224	254	474	504	105	205	255	475	505
Tolerance	30%														20%										30%				

TAPERS

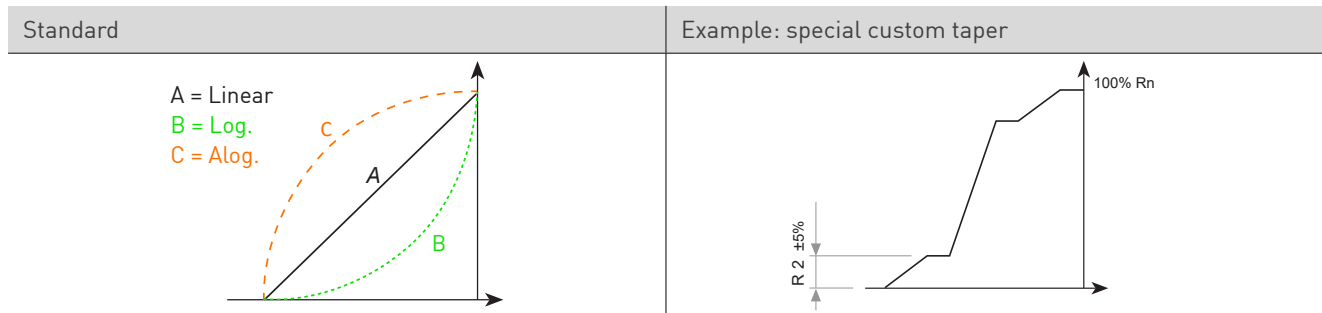

For more information on custom tapers contact Piher Sensing Systems.

SWITCH VERSION

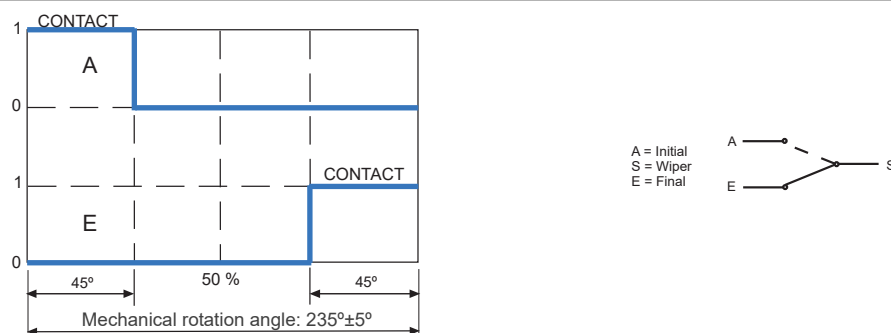

PT-6

6-mm carbon through-hole trimmer potentiometer

DETENTS / STOP POSITIONS

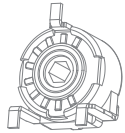
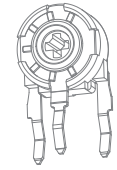
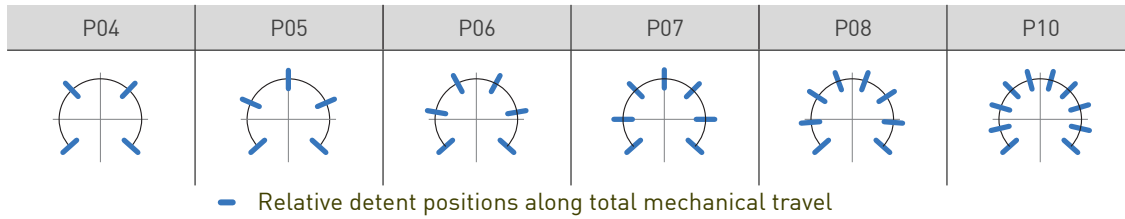

All detented versions will be studied case by case, more than 10 detents available on request.
 Unless otherwise specified the detents are evenly spaced (using the end points as reference).
 Standard mechanical life of detented versions: 100 cycles. Long life versions are available on request.
 Detent torque can vary from 1.2 to 2.5 times the standard potentiometer torque.
 Rotor color of detented versions is purple-violet.

PACKAGING

Bulk (1000 units per box)	Magazine / Automatic Insertion (80 units per magazine)	
All models	PT-6 V models	PT-6 WW models
Dimensions (mm): 185x85x40		

Embossed tape/reel packaging on request.

WIPER POSITION

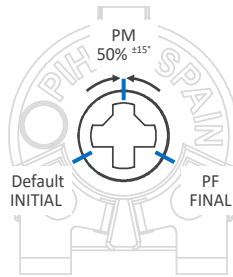

Wiper positioning on initial position is standard. Special delivery positions available on request.

DUAL GANG METAL SHAFT ON REQUEST - REF.: 6060

