



Sales Outline Drawing

Specifications:

Sound Level Category	Medium	
Mode of Operation	Fast Double Pulse @ 2 PPS for 15 Seconds, then 0.1s beep @ 1 PPS until reset.	
Voltage Rating	9 to 16 VDC	
Frequency	3900 ± 500 Hz	
Loudness @ 1M	70 to 75 dB(A) Typ.	
Sound Current Draw	40mA MAX	
Stack Level	BOTTOM	TOP
LED Color	GREEN	RED
LED Current Draw	25mA max	60mA MAX
Total Max Current Draw	125mA MAX	
Housing Material	6/6 Nylon, Color: Black	
Top Cap / Lens Material	6/6 Nylon, Color: Opaque White	
Storage Temperature	-40° to +70° C	
Operating Temperature	-30° to +60° C	
Mounting	Recommended hole size is 22.5 mm.	
Knurled Nut	The max recommended torque is 10 in-lbs.	
Cable	Gray, UL Style 21894, 300V, 105°C, 24AWG, Pb-Free Tinned Leads	
Weight (Typical)	35 grams	
NEMA 12	Approved with use of included gasket.	
Options	Please contact factory.	

Dimensions: Inches (mm) **cUL Recognized** **ROHS Compliant**

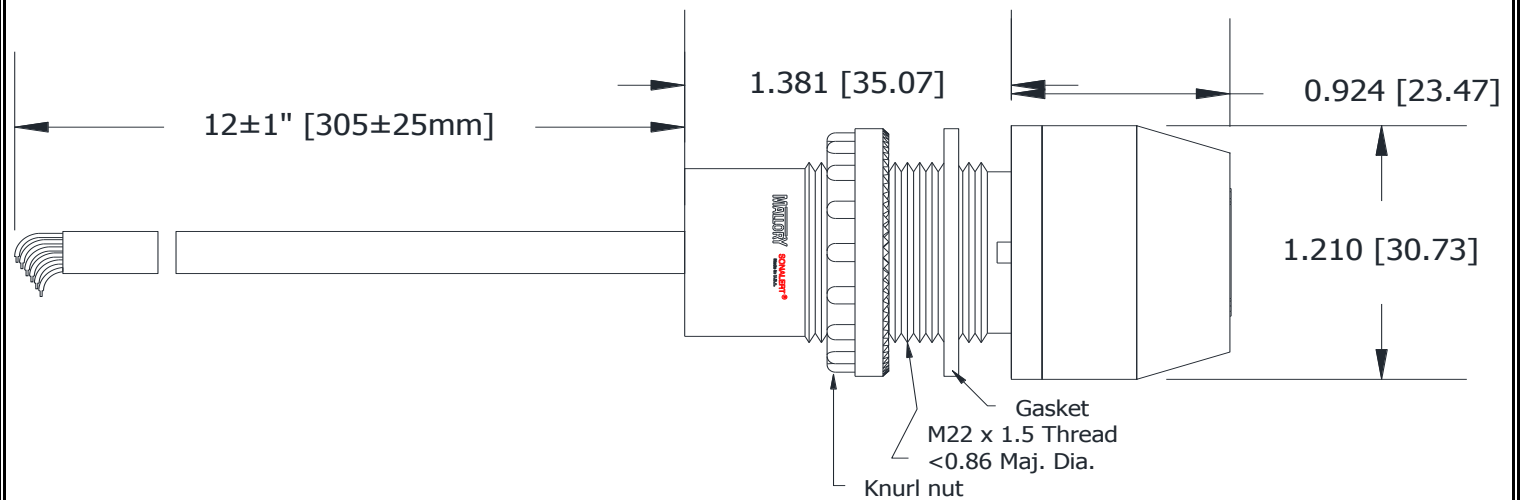

Connections:

- SOUND** BLACK wire to Ground and ORANGE wire to Positive
- BOTTOM** BROWN wire to Ground and GREEN wire to Positive
- TOP** BROWN wire to Ground and RED wire to Positive