

REV	ECN	APP'D
-	5277	JT 12-28-05
A	6078	<i>[Signature]</i> 6/14/07

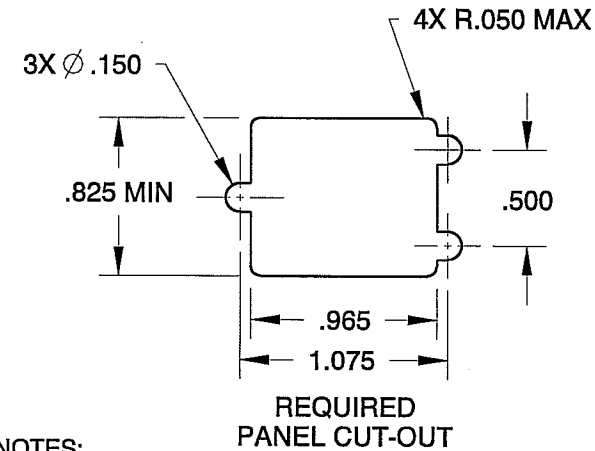
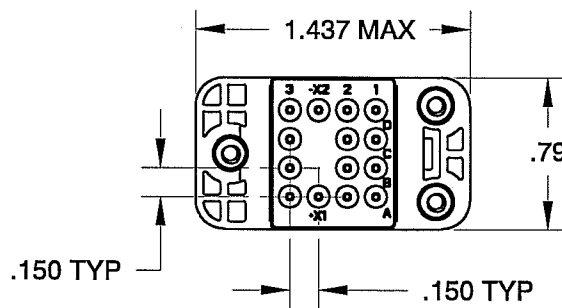
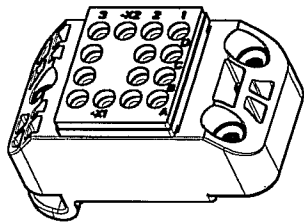

NOTES:

1. MATERIALS-
 SOCKET BODY: POLYETHERIMIDE PER ASTM-D-5205
 GROMMET: SILICONE RUBBER PER A-A-59588
 CONTACT RETAINERS: STAINLESS STEEL
 THREADED INSERTS: STAINLESS STEEL
 MOUNTING HARDWARE: STAINLESS STEEL
2. PART MEETS APPLICABLE REQUIREMENTS OF MIL-PRF-12883/44.
3. PART ACCEPTS M39029/101-553 SOCKET CONTACTS, SIZE 20/20 (SEE TABLE).
4. MOUNTING HARDWARE SEE TABLE.
5. WEIGHT: .024 LBS (10.9 GRAMS), NOT INCLUDING HARDWARE AND CONTACTS.
6. OPERATING TEMPERATURE: -65° C TO 125° C.

APCD P/N	HARDWARE SUPPLIED	CONTACT PKG SUPPLIED
JRE400100	NO	NO
JRE400101	NO	YES
JRE400110	YES	NO
JRE400111	YES	YES

P/N MARKING PER TABLE

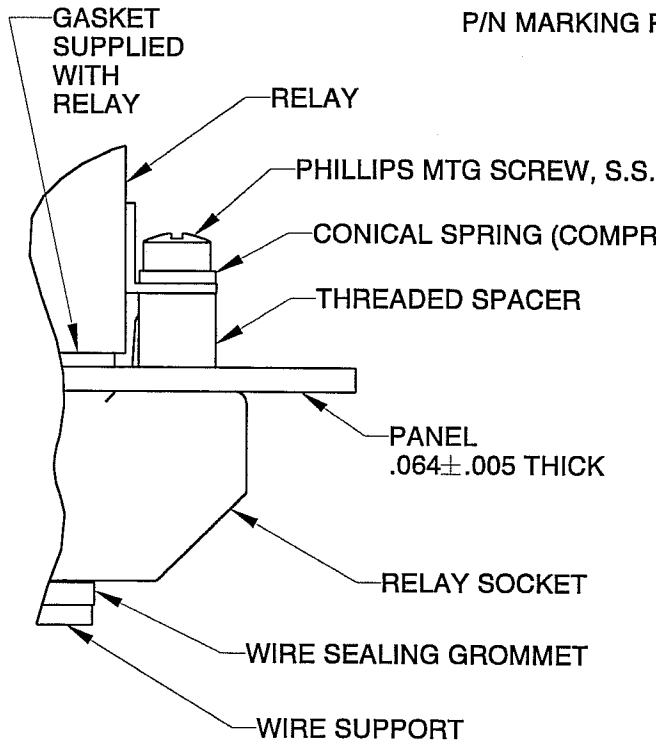
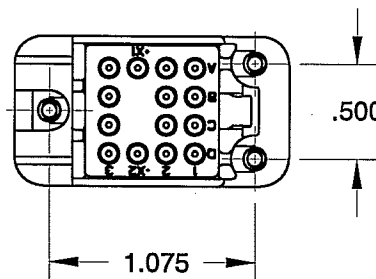
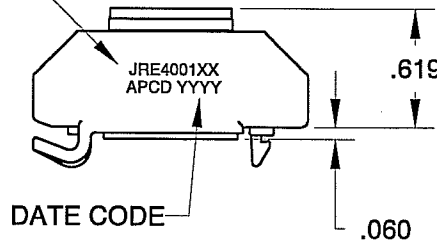

SCALE 2:1
MOUNTING CONFIGURATION

DIMENSIONS ANSI Y14.5M UNITS: INCHES Pro/E FILE	TOLERANCES .XX ±0.01 .XXX ±0.005 ANGLES ±2.0°	PROJECTION 	Amphenol Pcd SPECIFICATION DRAWING		TITLE RELAY SOCKET QUICK-MOUNT 4-POLE, 5-AMP		
			ENGR S. KONDO 17-Mar-04		SIZE	DWG NO.	REV
ORIGINAL 	THIS DOCUMENT CONTAINS PROPRIETARY INFORMATION WHICH IS THE CONFIDENTIAL PROPERTY OF AMPHENOL PCD PEABODY, MA, USA		CHKD <i>[Signature]</i> 6/14/07	APPD JACK TON 12-28-05	A	JRE400100	A
		CODE: 58982		SCALE: NONE		SHEET 1 OF 1	