

Package Outline

* = Similar Package

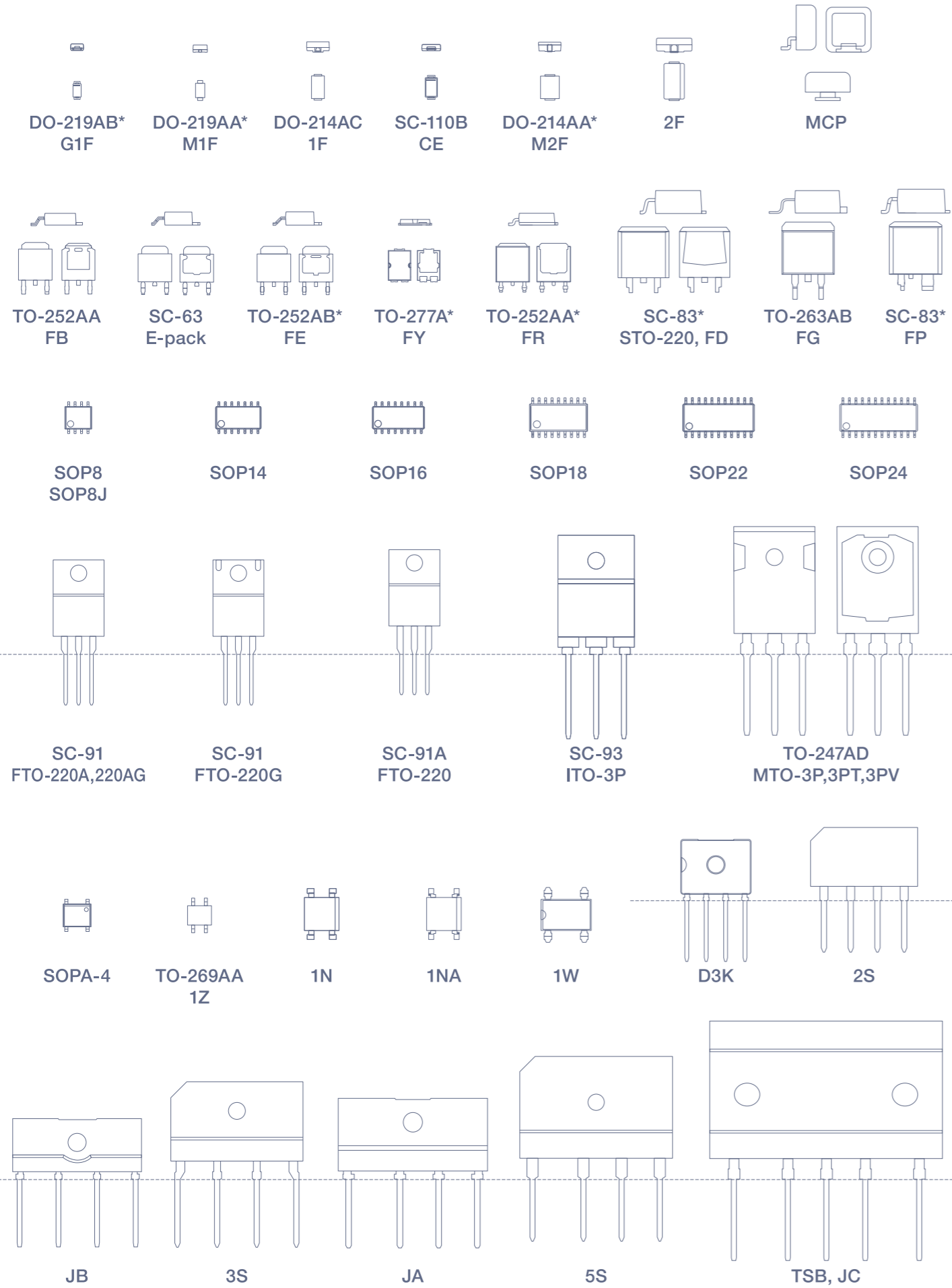

Semiconductor Product Catalog

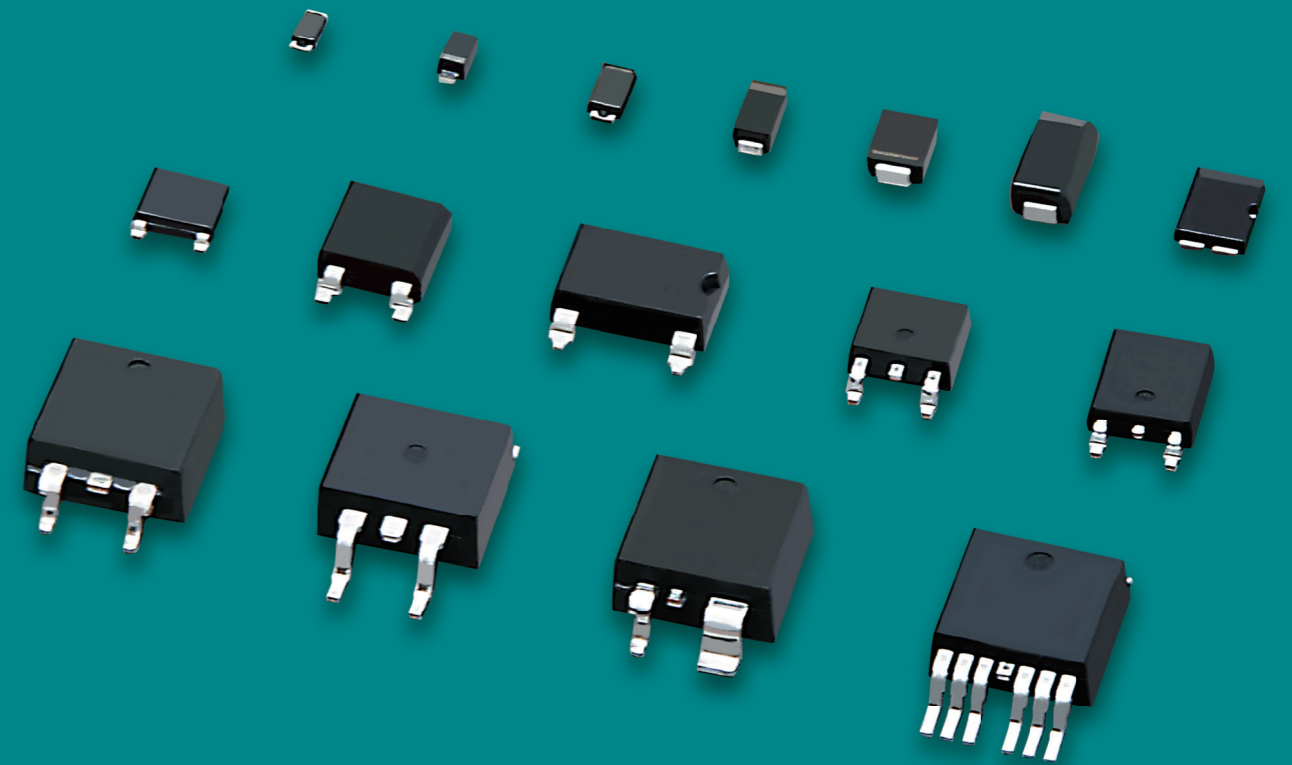

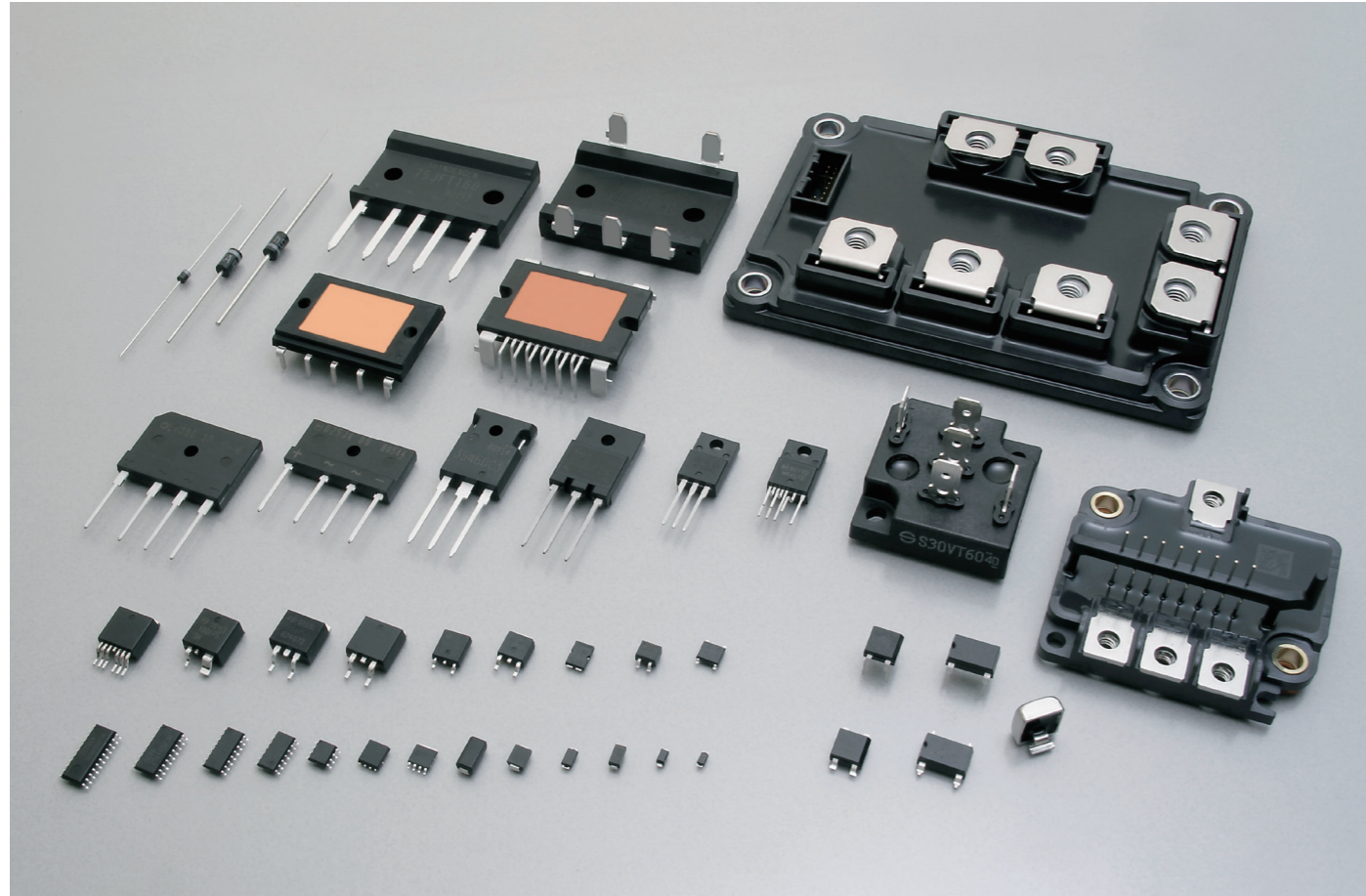

Notes

- ⚠ If you wish to use any such product, please be sure to refer to the specifications issued by Shindengen.
- ⚠ All products described or contained herein are designed with a quality level intended for use in standard applications requiring an ordinary level of reliability. If these products are to be used in equipment or devices for special or specific applications requiring an extremely high grade of quality or reliability in which failures or malfunctions of products may directly affect human life or health, a local Shindengen office must be contacted in advance to confirm that the intended use of the product is appropriate. Shindengen products are grouped into the following three applications according to the quality grade.
 - Standard applications
Computers, office automation and other office equipment, communication terminals, test and measurement equipment, audio/visual equipment, amusement equipment, consumer electronics, machine tools, personal electronic equipment, industrial equipment, etc.
 - Special applications
Transportation equipment (vehicles, ships, etc.), trunk-line communication equipment, traffic signal control systems, anti-disaster/crime systems, safety equipment, medical equipment, etc.
 - Specific applications
Nuclear reactor control systems, aircraft, aerospace equipment, submarine repeaters, life support equipment and systems, etc.
- ⚠ Although Shindengen continuously endeavors to enhance the quality and reliability of its products, customers are advised to consider and take safety measures in their design, such as redundancy, fire containment and anti-failure, so that personal injury, fires, or societal damages can be prevented.
- ⚠ Please note that all information described or contained herein is subject to change without notice due to product upgrades and other reasons. When buying Shindengen products, please contact the Company's offices or distributors to obtain the latest information.
- ⚠ Shindengen shall not bear any responsibility with regards to damages or infringement of any third-party patent rights and other intellectual property rights incurred due to the use of information on this website.
- ⚠ The information and materials on this website neither warrant the use of Shindengen's or any third party's patent rights and other intellectual property rights, nor grant license to such rights.
- ⚠ In the event that any product described or contained herein falls under the category of strategic products controlled under the Foreign Exchange and Foreign Trade Control Law of Japan, exporting of such products shall require an export license from the Japanese government in accordance with the above law.
- ⚠ No reprinting or reproduction of the materials on this website, either in whole or in part, is permitted without proper authorization from Shindengen.

SALES OFFICES

U.S.A.

Shindengen America, Inc. www.shindengen.com/
 2333 Waukegan Road Suite250, Bannockburn, IL.60015. U.S.A
 Phone:+1-847-444-1363 FAX:+1-847-444-0654

Europe

Shindengen UK Ltd. www.shindengen.co.uk/
Head Office
 Unit 1, 1 Tapper Walk, King's Cross, London, N1C 4AQ U.K.
 Phone:+44-20-3829-6980 FAX:+44-20-3725-6855
German Branch
 Niederkasseler Lohweg 189, 40547, Dusseldorf, Germany
 Phone:+49-211-4919680 FAX:+49-211-4986499

Asia

Shindengen Singapore PTE Ltd.
 750d, Chai Chee Road, #05-01,
 Viva Business Park, Singapore 469004
 Phone:+65-6445-0082 FAX:+65-6445-6089

Shindengen (H.K.) Co., Ltd.

Head Office
 Suite 2006B, 20/F., Exchange Tower, 33 Wang Chiu Road,
 Kowloon Bay, HK
 Phone:+852-2317-1884 FAX:+852-2314-8561
Taiwan Representative Office
 20Fl, No.85, Sec.1, Jhongsiao E. Road, Taipei, 10049,
 Taiwan, R.O.C.
 Phone:+886-2-2321-3990 FAX:+886-2-2358-3991

Shindengen (SHANGHAI) Electric Co., Ltd.

Room1506, Sheng Gaolnt'l Building, 137 Xian Xia Road,
 Chang Ning, Shanghai, China
 Phone:+86-21-6270-8000 FAX:+86-21-6270-0419

Shindengen Electric Mfg. Co., Ltd.

Seoul Office
 B701-4. 230, Simin-daero, Dongan-gu, Anyang-si,
 Gyeonggi-do, 14067 Korea
 Phone:+82-31-385-1431 FAX:+82-31-385-1430

Japan

Shindengen Electric MFG. Co., Ltd. www.shindengen.co.jp/

Head Office
 New-Ohtemachi Bldg., 2-2-1, Ohtemachi, Chiyoda-ku,
 Tokyo 100-0004, Japan
 Phone:+81-3-3279-4431 FAX:+81-3-3279-6478

Osaka Branch Office
 Minami Senba Heart Bldg., 2-3-2, Minami-Senba,
 Chuo-ku, Osaka City, Osaka 542-0081, Japan
 Phone:+81-6-6264-7770 FAX:+81-6-6260-1222

Nagoya Branch Office
 Nagoya Daiichi Bldg., 1-19-24, Nishiki, Naka-ku,
 Nagoya City, Aichi 460-0003, Japan
 Phone:+81-52-221-1361 FAX:+81-52-201-4780

Hamamatsu branch
 Hamamatsu Daiichi Seimei Nittsu Bldg., 110-5, Itaya-cho,
 Naka-ku, Hamamatsu City, Shizuoka 430-0928, Japan
 Phone:+81-53-450-3800 FAX:+81-53-450-3801

Utsunomiya Sales Office
 Flora Bldg., 1-9-15 Higashi Syukugou Utsunomiya City,
 Tochigi 321-0953, Japan
 Phone:+81-28-637-3615 FAX:+81-28-637-3115

- All specifications are subject to change without notice.
- Please consult us for the latest specifications before you order.
- Please use this products after reading manual well.

• Printed December 2018

This catalog includes the products which might be subject to the foreign exchange and foreign trade laws.

P3-6	INDEX
P7-10	GENERAL RECTIFYING DIODES
P11-20	BRIDGE DIODES
P21-30	SCHOTTKY BARRIER DIODES
P31-36	FAST RECOVERY DIODES
P37-40	THYRISTORS
P41-42	TRIACs
P43-44	SURGE ABSORBERS
P45-48	TVS DIODES
P49-54	POWER MOSFETs
P55-56	POWER MODULES
P57-60	POWER ICs
P61-80	OUTLINE DIMENSIONS
P81-82	PACKING SPECIFICATION
P85	NOTES ·How to Order ·Outline of Packing Form ·About AEC-Q101 & Automotive Grade

INDEX

Type No.	Page	Type No.	Page	Type No.	Page	Type No.	Page	Type No.	Page	Type No.	Page	Type No.	Page	Type No.	Page
D1F60	8	D2SB60A	14	D6SB60L	14	D20XB60	14	DE3L40A	32	DF30PC3M	26	K1V(A)12	38	LN25XB60	20
D1F60A	8	D2SBA60	14	D6SB80	14	D20XB80	14	DE3S4M	22	DF30SC3ML	26	K1V(A)16	38	M1F60	8
D1FE60	8	D3CE4S	22	D6SBN20	18	D20XBS6	18	DE3S6M	22	DF30SC4M	26	K1VZL09	38	M1F80	8
D1FH3	22	D3CE6S	22	D8FD60LUS	32	D25FD60V	8	DE5L60A	32	DF40PC3	26	K1VZL20	38	M1FE40	8
D1FJ4	22	D3CE15ST	22	D8JBB60V	14	D25JAB60V	14	DE5L60U	32	DF40SC3L	26	KC3FB40H	38	M1FE60	8
D1FJ8	22	D3CE20LUS	32	D8JBB80V	14	D25JAB80V	14	DE5LC20U	34	DF40SC4	26	KC5FB40H	38	M1FH3	22
D1FJ8A	22	D3CE60K	32	D10FDC10ST	26	D25SC6M	28	DE5LC40	34	DG1H3	22	KC5FB60H	38	M1FJ4	22
D1FJ10	22	D3CE60V	8	D10FR60V	8	D25SC6MR	28	DE5PC3	26	DG1H3A	22	KC5FB60HR	38	M1FK60	32
D1FK60	32	D3CE60VE	8	D10FY4R5ST	22	D25XB60	14	DE5S4M	22	DG1J10A	22	KC5FB60HRT	38	M1FL20U	32
D1FK70	32	D3F60	8	D10FY4R5SY	22	D25XB80	14	DE5S6M	22	DG1M3	22	KC8SF80	38	M1FL40U	32
D1FK100	32	D3FE60	8	D10FY6ST	22	D25XB100	14	DE5SC3ML	26	DG1M3A	22	KD3FB60	42	M1FM3	22
D1FK120	32	D3FJ10	22	D10FY6SY	22	D30FD60K	32	DE5SC4M	26	DG1N15A	22	KD3SF60	42	M1FP3	22
D1FL20U	32	D3FK60	32	D10FY10ST	22	D30FDC4S	26	DE5SC6M	26	DG1S4	22	KD3SF60E	42	M1FS4	22
D1FL40U	32	D3FP3	22	D10FY10SY	22	D30FDC10ST	26	DE5VE40	8	DG1S6	22	KD5SF60	42	M1FS6	22
D1FM3	22	D3FS4A	22	D10FY15ST	22	D30FDC15ST	26	DE10P3	22	DG1S6A	22	KD8SF60	42	M2F60	8
D1FP3	22	D3FS6	22	D10FY60VE	8	D30JCB100K	18	DE10PC3	26	DL04-18F1	46	KD12SF60	42	M2FH3	22
D1FS4	22	D3S4M	24	D10JBB60V	14	D30JCT120V	16	DE10S3L	22	DL04-33F1	46	KD16SF60	42	M2FL20U	32
D1FS4A	22	D3S6M	24	D10JBB80V	14	D30L60	34	DE10SC3L	26	DL04-36F1	46	KD20SF60	42	M2FM3	22
D1FS6	22	D3SB60	14	D10SBS4	18	D30SC4M	28	DE10SC4	26	G1V(A)8C	40	KL3L07	44	M3F60	8
D1FS6A	22	D3SB80	14	D10XB60	14	D30VC60	10	DF5VD60	10	G1V(A)10C	40	KL3N14	44	M3FE40	8
D1FT4	22	D3SBA60	14	D10XB60H	14	D30XBN20	18	DF8L60US	32	G1V(A)12C	40	KL3R20	44	M3FE60	8
D1FT4A	22	D4F60	8	D10XB80	14	D30XT80	16	DF10L60	32	G1V(A)13C	40	KL3Z07	44	M3FL20U	32
D1FT6	22	D4SB60L	14	D15FR4ST	22	D40FDC10ST	26	DF10LC20U	34	G1V(A)14C	40	KL3Z18	44	MCZ5203SE	60
D1FT6A	22	D4SB80	14	D15FR60V	8	D40FDC15ST	26	DF10LC30	34	G1V(A)15C	40	KP20NU11	44	MCZ5205SE	60
D1FT10	22	D4SBL20U	18	D15FY4R5ST	22	D45JCT120V	16	DF10NC15	26	G1V(A)20C	40	KP40NU11	44	MCZ5207SG	60
D1FT10A	22	D4SBL40	18	D15FY4R5SY	22	D45JCT160V	16	DF10SC4M	26	G1V(B)20C	40	KP40RU22	44	MCZ5208SG	60
D1FT15A	22	D4SBN20	18	D15FY6ST	22	D45XT80	16	DF10SC6	26	G1V(B)22C	40	KU4F8	44	MCZ5209SN	60
D1N60	8	D4SBS4	18	D15FY6SY	22	D45XT160	16	DF10SC9	26	G1V(B)24C	40	KU4F12	44	MCZ5211ST	60
D1N80	8	D4SBS6	18	D15FY10ST	22	D50JCB80V	14	DF15JC10	26	G1VL8C	40	KU5S31NS	44	MCZ5213ST	60
D1NF60	32	D5CE4S	22	D15FY10SY	22	D50XB80	14	DF15NC15	26	G1VL10C	40	KU10L08	44	MCZ5303SG	60
D1NK60	32	D5FE60	8	D15FY15ST	22	D70JHB80V	14	DF15SC4M	26	G1VL15C	40	KU10N14	44	MCZ5303SH	60
D1NK100	32	D5FY4R5ST	22	D15JAB60V	14	D75JFT80V	16	DF15VD60	10	G1VL20C	40	KU10NU11	44	MCZ5601SC	60
D1NL20U	32	D5FY4R5SY	22	D15JAB80V	14	D100JHT80V	18	DF16VC60R	10	G1VL22C	40	KU10NU13	44	MG020200	56
D1NL40U	32	D5FY6ST	22	D15XB60	14	D100JHT120V	18	DF20JC10	26	G1VL24C	40	KU10R23NS	44	MG020201	56
D1NS4	24	D5FY6SY	22	D15XB60H	14	D100JHT160V	18	DF20L60	32	K1V10	38	KU10R27NS	44	MG031B090004A	56
D1NS6	24	D5FY10ST	22	D15XB80	14	D120LC40	36	DF20L60U	32	K1V11	38	KU10R29NS	44	MG031G148004A	56
D1UBA80	12	D5FY10SY	22	D15XB100	14	D120LC40B	36	DF20LC20US	34	K1V12	38	KU10S31NS	44	MG032A4207R5A	56
D2F60	8	D5FY15ST	22	D15XBN20	18	D120SC4M	30	DF20LC30	34	K1V14	38	KU10S35NS	44	MG032B420010A	56
D2FK60	32	D5FY60K	32	D15XBS6	18	D120SC6M	30	DF20NC15	26	K1V22	38	KU15N14	44	MH2501SC	60
D2FL20U	32	D5SB60	14	D20FD60LU	32	D180SC4M	30	DF20PC3M	26	K1V22(W)	38	LL15XB60	20	MH2511SC	60
D2FL40	32	D5SB80	14	D20FDC10ST	26	D180SC6M	30	DF20SC4M	26	K1V24	38	LL25XB60	20	MS1003SH	60
D2FS4	22	D5SBA60	14	D20FDC15ST	26	D200LC40B	36	DF20SC9M	26	K1V24(W)	38	LL25XB80F	20	MS1004SH	60
D2FS6	22	D6FEC4ST	26	D20FDC20L	34	D240LC40	36	DF25SC6M	26	K1V26	38	LN1F60	8	MS1005SK	60
D2L20U	32	D6FEC10ST	26	D20FDC20LUS	34	D240SC4M	30	DF25V60	8	K1V26(W)	38	LN1WBA60	20	MS1006SK	60
D2L40U	32	D6FEC12ST	26	D20FR4ST	22	D240SC6M	30	DF30JC4	26	K1V36(W)	38	LN4SB60	20	MV1001SC	58
D2S4M	24	D6FEC15ST	26	D20LC20U	36	D360SC4M	30	DF30JC6	26	K1V38(W)	38	LN6SB60	20	MV1002SC	58
D2S6M	24	D6JBB60V	14	D20LC40	36	D360SC6M	30	DF30JC10	26	K1V(A)10	38	LN15XB60	20	MV1011SC	58
D2SB60	14	D6JBB80V	14	D20SC9M	28	DE3L20UA	32	DF30NC15	26	K1V(A)11	38	LN15XB60H	20	MV1012SC	58

INDEX









Type No.	Page	Type No.	Page	Type No.	Page	Type No.	Page	Type No.	Page	Type No.	Page	Type No.	Page	Type No.	Page
MV2002SG	58	P18LA12SL	50	P54B4SN	50	S1WB(A)60	12	S20VTA80	18	SF20L60MSM	34	ST02-47G1	46	ST20-33F2	46
MV2052SG	58	P19LA10SL	50	P55F6EN	52	S1WB(A)60B	12	S20WB60	16	SF20L60MVM	34	ST02-58G1	46	ST20-36F2	46
P0R5B60HP2	54	P20B12SL	50	P60B4EL	50	S1WB(A)80	12	S20WB80	16	SF20LC30M	36	ST02-75F1	46	ST20-47F2	46
P1B52HP2	54	P20B12SN	50	P60B4SN	50	S1ZAS4	30	S25VB60	16	SG5L20USM	34	ST02-82F1	46	ST60-40MF	46
P1FE90VX3	54	P20F50HP2	54	P60B6EL	50	S1ZB60	12	S25VB80	16	SG5LC20USM	36	ST02-100F1	46	ST60-48MF	46
P1R5B40HP2	54	P20FE12SLK	50	P60B6EN	50	S1ZB80	12	S30K60T	34	SG5S4M	24	ST02-120F1	46	ST70-27F	46
P2B60HP2F	54	P20FH50HP2	54	P60B6SN	50	S2K100	32	S30K60V	34	SG5S6M	24	ST02-140F1	46	ST70-27FZ	46
P2FE60VX5K	54	P21F28HP2	54	P64LF6QL	50	S2L20U	32	S30K100V	34	SG5S9M	24	ST02-170F1	46	ST70-27MF	46
P2R5B52HP2F	54	P22F10SN	52	P64LF6QN	50	S2L40U	32	S30SC4MT	28	SG8SC4M	28	ST02-200F1	46	ST70-30MF	46
P3B28HP2	54	P22FE4SBK	50	P66F7R5SN	52	S2L60	32	S30SC6MT	28	SG10L20USM	34	ST02-280F1	46	ST80-14MF	46
P3F60HP2	54	P23F40HP2FM	54	P70F5EN	52	S2V60	8	S30TC15T	28	SG10LC20USM	36	ST02-320F1	46	UD2KB80	14
P4B40HP2	54	P23LA10SL	50	P70F7R5EN	52	S2V80	8	S30V60T	10	SG10SC3LM	28	ST02D-82	48	UD3KB80	14
P4B60HP2F	54	P24B4SB	50	P70FP12SNK	52	S2VB60	16	S30V80V	10	SG10SC4M	28	ST02D-140	48	UD4KB80	14
P4F60HP2	54	P25B6EB	50	P72LF7R5SL	50	S2WB(A)80	12	S30VT60	18	SG10SC6M	28	ST02D-140F2	48	UD6KBA80	14
P5B52HP2	54	P25LA12SL	50	P72LF7R5SN	50	S3K60	32	S30VT80	18	SG10SC9M	28	ST02D-170	48	UD8KBA80	14
P5F50HP2	54	P25LF12SL	50	P80FG6EAL	52	S3L20U	32	S30VT160	18	SG10TC15M	28	ST02D-170F2	48	VR-61F1	44
P5F50HP2F	54	P25LF12SN	50	P80FG7R5EN	52	S3L40U	32	S30VTA60	18	SG15SC4M	28	ST02D-200	48		
P5F60HP2	54	P26B10SL	50	P80FH5ENK	52	S3L60	32	S30VTA80	18	SG15SC6M	28	ST02DH-280	48		
P6B28HP2	54	P26B10SN	50	P82F7R5SN	52	S3V60	8	S30VTA160	18	SG20JC6M	28	ST02DH-320	48		
P6B40HP2	54	P26F28HP2	54	P85FG6EAL	52	S3V80	8	S40HC1R5T	28	SG20LC20USM	36	ST03-43F1	46		
P6B52HP2	54	P26FE10SLK	50	P85W28HP2F	54	S3V100D	8	S40T15V	24	SG20SC3LM	28	ST03-47F1	46		
P6F50HP2	54	P30B10EL	50	P86F6SN	52	S3WB60	16	S50VB60	16	SG20SC4M	28	ST03-58F1	46		
P6FE25VX5K	54	P30FE4SLK	50	P88FP10SNK	52	S4VB60	16	S50VB80	16	SG20SC6M	28	ST03-68F1	46		
P7F60HP2	54	P30FE6SLK	50	P90FG5R5SL	52	S5VB60	16	S60HC1R5T	28	SG20SC9M	28	ST03-240F1	46		
P7FH60HP2	54	P30FE7R5SLK	50	P94FG5R5SL	52	S10VB60	16	S60HC3T	28	SG20TC10M	28	ST03D-82	48		
P8B10SB	50	P30LA10SL	50	P98LF6QL	50	S10VT60	18	S60JC10V	28	SG20TC12M	28	ST03D-140	48		
P8B28HP2	54	P30W60HP2V	54	P98LF6QN	50	S10VT80	18	S60L120D	34	SG20TC15M	28	ST03D-170	48		
P8B30HP2	54	P32B12SN	50	P100FA7R5EN	52	S10VTA60	18	S60SC3LT	28	SG30JC6M	28	ST03D-200	48		
P8F28HP2	54	P32F12SN	52	P100FH4ENK	52	S10VTA80	18	S60SC4MT	28	SG30SC3LM	28	ST03DH-240	48		
P8F50HP2	54	P32FG15SL	52	P100FP12SNK	52	S10WB60	16	S60SC6MT	28	SG30SC4M	28	ST04-12F1	46		
P8FE10SBK	50	P32LF10SL	50	P105LF4QL	50	S15VB60	16	S90T15V	24	SG30SC6M	28	ST04-14F1	46		
P9B30HP2F	54	P32LF10SN	50	P105LF4QN	50	S15VT60	18	SF3K60M	34	SG30TC10M	28	ST04-16F1	46		
P9B40HP2	54	P34F6EL	52	P126FP10SNK	52	S15VT80	18	SF3L60U	34	SG30TC12M	28	ST04-18F1	46		
P10B28HP2	54	P36F28HP2	54	P140LF4QL	50	S15VTA60	18	SF5K60M	34	SG30TC15M	28	ST04-20F1	46		
P10F50HP2	54	P36FH28HP2	54	P140LF4QN	50	S15VTA80	18	SF5L40UM	34	SG40TC10M	28	ST04-24F1	46		
P10F60HP2	54	P40B6SL	50	P153FP6SNK	52	S15WB60	16	SF5L60U	34	SG40TC12M	28	ST04-27F1	46		
P12F60HP2	54	P40B10SL	50	P168FP7R5SNK	52	S20K60T	34	SF5LC40UM	36	ST02-12G1	46	ST04-30F1	46		
P12FE7R5SBK	50	P40B10SN	50	P175FP4SNK	52	S20K100V	34	SF8K60M	34	ST02-14G1	46	ST04-33F1	46		
P13F28HP2	54	P40F10SN	52	P180FP4SNK	52	S20LC20UST	36	SF8K60USM	34	ST02-16G1	46	ST04-36F1	46		
P13F50HP2	54	P40F12SN	52	P180FP6SNK	52	S20LC30T	36	SF10K60M	34	ST02-18G1	46	ST04-39F1	46		
P14FE6SBK	50	P40LF12SL	50	P211FZ4QMKA	52	S20LC40UT	36	SF10KC60M	36	ST02-20G1	46	ST06-18CE	46		
P15F50HP2	54	P40LF12SN	50	P240FZ4QLA	52	S20LC40UV	36	SF10L60U	34	ST02-24G1	46	ST06-27CE	46		
P15F60HP2	54	P42F6EN	52	S1NAD80	10	S20LC60UST	36	SF10L60MSM	34	ST02-27G1	46	ST06-30CE	46		
P15F60HP2F	54	P46LF7R5SL	50	S1NB60	12	S20LC60USV	36	SF10L60MVM	34	ST02-30G1	46	ST06-33CE	46		
P15FH60HP2	54	P46LF7R5SN	50	S1NB80	12	S20SC9MT	28	SF10LC40UM	36	ST02-33G1	46	ST06-36CE	46		
P15LA12SL	50	P50F10SN	52	S1NBB80	12	S20VT60	18	SF20K60M	34	ST02-36G1	46	ST06-39CE	46		
P16B6SB	50	P50LF10SL	50	S1NBC60	12	S20VT80	18	SF20KC60M	36	ST02-39G1	46	ST20-27F2	46		
P17F28HP2	54	P50LF10SN	50	S1NBC80	12	S20VTA60	18	SF20L60U	34	ST02-43G1	46	ST20-30F2	46		

GENERAL RECTIFYING DIODES



General Rectifying Diodes are defined as high-voltage and PN junction type devices.

These devices utilize our original glass passivation which is physically stable with a superior structure for resistance against heat and humidity. Variations are available for breakdown voltage up to 800V and output current from 1 to 30A.

Single

Surface Mount							
Package	JEDEC Code JEITA Code House Name	Fig.	If(AV) [A]	VRRM [V]			Remarks
				400	600	800	
 3.9 × 1.8 × 1.4(mm)	DO-219AA similar M1F	B2	1		M1F60 M1FE60	M1F80	① → ← ②
			2	M1FE40			
 5.0 × 2.5 × 2.0(mm)	DO-214AC 1F	B3-1	1		D1F60 D1FE60		① → ← ②
			1.1		LN1F60		
			1.2		D1F60A		
 4.7 × 2.4 × 0.98(mm)	SC-110B CE	B5-1	3		D3CE60V		① → ← ②
			3.5		★ D3CE60VE		
 5.1 × 3.75 × 2.0(mm)	DO-214AA similar M2F	B6	1.2		M2F60		① → ← ②
			3	M3FE40	M3F60 M3FE60		
			1.4		D2F60		
		B9-1	3		D3F60 D3FE60		
			4		D4F60		
 7.6 × 4.0 × 2.8(mm)	SC-63 E-pack	B9-1	5		D5FE60		① → ← ②
			5	DE5VE40			
 9.5 × 6.6 × 2.65(mm)	TO-277A similar FY	G4	10		■ D10FY60VE		① → ← ②
			10		■ D10FR60V		
 6.5 × 4.5 × 1.1(mm)	TO-252AA similar FR	G5	15		■ D15FR60V		① → ← ②
			15		■ D15FR60V		
 9.6 × 6.6 × 2.3(mm)	SC-83 similar STO-220	H1-2	25		DF25V60		① → ← ②
			25		DF25V60		
 13.2 × 10.2 × 4.7(mm)	SC-83 similar FD	H2-1	25		D25FD60V		① → ← ②
			25		D25FD60V		

■ : New product ★ : Under development

Axial							
Package	JEDEC Code JEITA Code House Name	Fig.	If(AV) [A]	VRRM [V]			Remarks
				400	600	800	
 3.0 × φ 2.6(mm)	AX057	A1	1		D1N60	D1N80	① → ← ②
 7.0 × φ 4.4(mm)	AX10	A5-1	1.7		S2V60	S2V80	
 7.0 × φ 4.4(mm)	AX14	A7	3			S3V100D	Spec.Code □060=52mm Spec.Code □070=26mm
			3.5		S3V60	S3V80	

Single

Surface Mount														
JEDEC Code JEITA Code House Name	Fig.	Type No.	Absolute Maximum Ratings					Electrical Characteristics			High ESD Capability Vesd (typ) [kV]	Weight (mg)	Based on AEC-Q101	Automotive
			If (AV) [A]	Conditions Ta [°C]	IFSM [A]	VRRM [V]	Tj [°C]	Vf (max) [V]	Conditions If [A]	Ir (max) Vr=VRRM [μA]				
DO-219AA similar M1F	B2	M1F60	1.0	25	25	600	150	1.10	1.0	10	—	25	—	○
		M1FE60	1.0	129 *1	30	600	150	1.10	1.0	10	25	25	○	○
		M1F80	1.0	25	25	800	150	1.10	1.0	10	—	25	—	○
		M1FE40	2.0	103 *2	25	400	150	1.10	1.0	10	—	25	○	○
DO-214AC 1F	B3-1	D1F60	1.0	25	25	600	150	1.10	1.0	10	—	58	—	○
		D1FE60	1.0	126 *1	30	600	150	1.10	1.0	10	25	58	○	○
		LN1F60 *3	1.1	25	25	600	150	1.05	0.8	10	—	58	—	—
		D1F60A	1.2	25	45	600	150	0.97	1.2	10	—	58	—	○
SC-110B CE	B5-1	D3CE60V	3.0	101 *1	50	600	150	1.10	3.0	10	—	29	—	○
		★ D3CE60VE	3.5	93 *1	60	600	-55 to 150	1.10	3.5	10	25	30	○	■
DO-214AA similar M2F	B6	M2F60	1.2	51	50	600	150	0.97	1.2	10	—	75	—	○
		M3FE40	3.0	76 *1	75	400	150	1.10	3.0	10	30	75	—	○
		M3F60	3.0	100 *1	90	600	150	1.05	3.0	10	—	75	—	○
		M3FE60	3.0	76 *1	90	600	150	1.05	3.0	10	25	76	○	○
— 2F	B9-1	D2F60	1.4	25	60	600	150	1.05	1.4	10	—	175	—	○
		D3F60	3.0	80 *1	150	600	150	1.05	3.0	10	—	175	—	○
		D3FE60	3.0	105 *1	150	600	150	1.05	3.0	10	25	180	○	○
		D4F60	4.0	68 *1	200	600	150	0.95	4.0	10	—	175	—	○
— SC-63 E-pack TO-277A FY	G4	D5FE60	5.0	82 *1	300	600	150	0.95	5.0	10	25	180	○	○
		DE5VE40	5.0	130 *2	80	400	150	1.00	5.0	10	30	310	—	■
TO-252AA similar FR	G5	■ D10FY60VE	10	120 *1	220	600	-55 to 150	1.10	10	10	25	108	○	○
		■ D10FR60V	10.0	130 *2	200	600	-55 to 150	1.05	10	10	—	1092	—	■
SC-83 similar STO-220	H1-2	■ D15FR60V	15.0	125 *2	300	600	-55 to 150	1.05	15	10	—	1092	—	■
		DF25V60	25.0	136 *2	400	600	150	1.10	25.0	10	—	1420	—	—
SC-83 similar FD	H2-1	D25FD60V	25.0	113 *2	450	600	150	1.10	25.0	10	—	1420	○	○

■ : New product ★ : Under development *1 : Tl *2 : Tc *3 : trr(max)=3.5μs ■ : Please contact us.

Axial														
JEDEC Code JEITA Code House Name	Fig.	Type No.	Absolute Maximum Ratings					Electrical Characteristics			High ESD Capability Vesd (typ) [kV]	Weight (mg)	Based on AEC-Q101	Automotive
			If (AV) [A]	Conditions Ta [°C]	IFSM [A]	VRRM [V]	Tj [°C]	Vf (max) [V]	Conditions If [A]	Ir (max) Vr=VRRM [μA]				
— AX57	A1	D1N60	1.0	25	30	600	150	1.05	1.0	10	—	185	—	—
		D1N80	1.0	25	30	800	150	1.05	1.0	10	—	185	—	—
— AX10	A5-1	S2V60	1.7	40	60	600	150	1.05	1.7	10	—	657	—	—
		S2V80	1.7	40	60	800	150	1.05	1.7	10	—	657	—	—
— AX14	A7	S3V100D	3.0	130 *1	150	800	150	1.05	3.0	10 *2	—	1060	—	—
		S3V60	3.5	40	120	600	150	1.05	2.6	10	—	1060	—	—
		S3V80	3.5	40	120	800	150	1.05	2.6	10	—	1060	—	—

*1 : Tl *2 : Vr=1000V

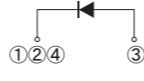

GENERAL RECTIFYING DIODES

Single

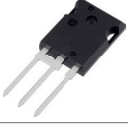
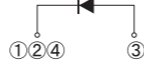
Two Terminal Type							
Package	JEDEC Code JEITA Code House Name	Fig.	I _{F(AV)} [A]	V _{RRM} [V]			Remarks
				400	600	800	
 41.0 × 16.0 × 5.0(mm)	TO-247AD — MTO-3PT	K2	30		S30V60T		

Three Terminal Type							
Package	JEDEC Code JEITA Code House Name	Fig.	I _{F(AV)} [A]	V _{RRM} [V]			Remarks
				400	600	800	
 41.0 × 16.0 × 5.0(mm)	TO-247AD — MTO-3PV	K6	30		S30V80V		

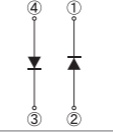
Array

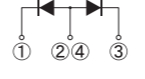
Surface Mount							
Package	JEDEC Code JEITA Code House Name	Fig.	I _{F(AV)} [A]	V _{RRM} [V]			Remarks
				400	600	800	
 10.0 × 6.8 × 2.6(mm)	— — 1NA	C6-2	3		S1NAD80		
 13.2 × 10.2 × 4.7(mm)	— — SC-83 similar STO-220	H1-5	5		DF5VD60		
			15		DF15VD60		
		H1-7	16		DF16VC60R		

Diode Module

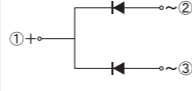
Diode Module							
Package	JEDEC Code JEITA Code House Name	Fig.	I _{F(AV)} [A]	V _{RRM} [V]			Remarks
				400	600	800	
 22.3 × 22.3 × 25.0(mm)	— — D30VC	E2	30		D30VC60		

Single

Two Terminal Type														
Package		Type No.	Absolute Maximum Ratings					Electrical Characteristics			High ESD Capability V _{ESD} (typ) [kV]	Weight (mg)	Based on AEC-Q101	Automotive
JEDEC Code JEITA Code House Name	Fig.		I _F (AV) [A]	Conditions T _c [°C]	I _{FSM} [A]	V _{RRM} [V]	T _j [°C]	V _F (max) [V]	Conditions I _F [A]	I _R (max) V _R =V _{RRM} [μA]				
TO-247AD — MTO-3PT	K2	S30V60T	30	119	360	600	150	1.1	30	10	—	5130	—	—

Three Terminal Type														
Package		Type No.	Absolute Maximum Ratings					Electrical Characteristics			High ESD Capability V _{ESD} (typ) [kV]	Weight (mg)	Based on AEC-Q101	Automotive
JEDEC Code JEITA Code House Name	Fig.		I _F (AV) [A]	Conditions T _c [°C]	I _{FSM} [A]	V _{RRM} [V]	T _j [°C]	V _F (max) [V]	Conditions I _F [A]	I _R (max) V _R =V _{RRM} [μA]				
TO-247AD — MTO-3PV	K6	S30V80V	30	131	450	800	150	1.1	30	10	—	6220	—	○

Array

Surface Mount														
Package		Type No.	Absolute Maximum Ratings					Electrical Characteristics			High ESD Capability V _{ESD} (typ) [kV]	Weight (mg)	Based on AEC-Q101	Automotive
JEDEC Code JEITA Code House Name	Fig.		I _F (AV) [A]	Conditions T _c [°C]	I _{FSM} [A]	V _{RRM} [V]	T _j [°C]	V _F (max) [V]	Conditions I _F [A]	I _R (max) V _R =V _{RRM} [μA]				
— — 1NA	C6-2	S1NAD80	3	102 *	110	800	150	1.05	0.75	10	—	290	—	—
— — SC-83 similar STO-220	H1-5	DF5VD60	5	140	140	600	150	1.05	2.50	10	—	1420	—	—
		DF15VD60	15	127	190	600	150	1.05	7.50	10	—	1420	—	—
	H1-7	DF16VC60R	16	124	190	600	150	1.05	8.00	10	—	1420	—	—

* : Tl

Diode Module







Diode Module														
Package		Type No.	Absolute Maximum Ratings					Electrical Characteristics			High ESD Capability V _{ESD} (typ) [kV]	Weight (mg)	Based on AEC-Q101	Automotive
JEDEC Code JEITA Code House Name	Fig.		I _F (AV) [A]	Conditions T _c [°C]	I _{FSM} [A]	V _{RRM} [V]	T _j [°C]	V _F (max) [V]	Conditions I _F [A]	I _R (max) V _R =V _{RRM} [μA]				
— — D30VC	E2	D30VC60	30	124	300	600	150	1.05	15	10	—	12100	—	—

BRIDGE DIODES

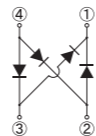





Bridge Diodes are suitable for the rectification of commercial voltage.

Variations are available for various packaging as well as high voltage (Max 1600V), high IFSM, low VF, and low noise.

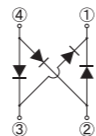
Small Bridge Diodes

Surface Mount							
Package	JEDEC Code JEITA Code House Name	Fig.	IF(AV) [A]	VRRM [V]			Remarks
				600	800	1000	
 7.0 × 4.7 × 2.6(mm)	TO-269AA 1Z	C2-1	0.8	S1ZB60	S1ZB80		
 6.2 × 5.15 × 1.45(mm)	SOPA-4	C1	1		D1UBA80		
 10.0 × 6.8 × 2.6(mm)	1N	C4	1	S1NB60	S1NB80		
 10.0 × 6.8 × 2.6(mm)	1NA	C6-1	1		S1NBB80		
 10.0 × 6.8 × 2.6(mm)	1NA	C6-1	1.5	S1NBC60	S1NBC80		
 10.6 × 10.2 × 3.1(mm)	1W	C8	1	S1WB(A)60 S1WB(A)60B	S1WB(A)80		
			2		 S2WB(A)80		

 : New product

THD (Through Hole Device)							
Package	JEDEC Code JEITA Code House Name	Fig.	IF(AV) [A]	VRRM [V]			Remarks
				600	800	1000	
 3.8 × 4.7 × 2.5(mm)	1Z	C3	0.8	S1ZB60	S1ZB80		
 6.5 × 6.8 × 2.5(mm)	1N	C5	1	S1NB60	S1NB80		
 6.5 × 6.8 × 2.5(mm)	1NA	C7	1		S1NBB80		
 6.5 × 6.8 × 2.5(mm)	1NA	C7	1.5	S1NBC60	S1NBC80		
 6.2 × 10.2 × 3.0(mm)	1W	C9	1	S1WB(A)60 S1WB(A)60B	S1WB(A)80		
			2		 S2WB(A)80		

 : New product

Small Bridge Diodes

Surface Mount														
JEDEC Code JEITA Code House Name	Fig.	Type No.	Spec. Code	Absolute Maximum Ratings					Electrical Characteristics			Weight (mg)	UL	Automotive
				IF (AV) [A]	Conditions Ta [°C]	IFSM [A]	VRRM [V]	Tj [°C]	Vf (max) [V]	Conditions IF [A]	IR (max) VR=VRRM [μA]			
TO-269AA	C2-1	S1ZB60	-7072	0.8	25	30	600	150	1.05	0.40	10	130	-	-
1Z		S1ZB80	-7072	0.8	25	30	800	150	1.05	0.40	10	130	-	-
SOPA-4	C1	D1UBA80	-7062	1.0	25	30	800	150	0.95	0.40	10	87	-	-
1N	C4	S1NB60	-7062	1.0	25	30	600	150	1.05	0.50	10	290	-	-
1N		S1NB80	-7062	1.0	25	30	800	150	1.05	0.50	10	290	-	-
1NA	C6-1	S1NBB80	-7062	1.0	26	50	800	150	1.05	0.50	10	290	-	-
1NA		S1NBC60	-7062	1.5	105 *	60	600	150	1.05	0.75	10	290	-	-
1NA		S1NBC80	-7062	1.5	105 *	60	800	150	1.05	0.75	10	290	-	-
1W	C8	S1WB(A)60	-7062	1.0	25	30	600	150	1.00	0.50	10	520	-	-
1W		S1WB(A)60B	-7062	1.0	25	50	600	150	1.00	0.50	10	520	-	-
1W		S1WB(A)80	-7062	1.0	25	30	800	150	1.00	0.50	10	520	-	-
1W		 S2WB(A)80	-7062	2.0	112 *	50	800	-40 to 150	1.05	1.00	10	520	-	-











 : New product * : TI

THD (Through Hole Device)														
JEDEC Code JEITA Code House Name	Fig.	Type No.	Spec. Code	Absolute Maximum Ratings					Electrical Characteristics			Weight (mg)	UL	Automotive
				IF (AV) [A]	Conditions Ta [°C]	IFSM [A]	VRRM [V]	Tj [°C]	Vf (max) [V]	Conditions IF [A]	IR (max) VR=VRRM [μA]			
1Z	C3	S1ZB60	-7101	0.8	25	30	600	150	1.05	0.40	10	130	-	-
1Z		S1ZB80	-7101	0.8	25	30	800	150	1.05	0.40	10	130	-	-
1N	C5	S1NB60	-7101	1.0	25	30	600	150	1.05	0.50	10	290	-	-
1N		S1NB80	-7101	1.0	25	30	800	150	1.05	0.50	10	290	-	-
1NA	C7	S1NBB80	-7101	1.0	26	50	800	150	1.05	0.50	10	290	-	-
1NA		S1NBC60	-7101	1.5	105 *	60	600	150	1.05	0.75	10	290	-	-
1NA		S1NBC80	-7101	1.5	105 *	60	800	150	1.05	0.75	10	290	-	-
1W	C9	S1WB(A)60	-7101	1.0	25	30	600	150	1.00	0.50	10	520	-	-
1W		S1WB(A)60B	-7101	1.0	25	50	600	150	1.00	0.50	10	520	-	-
1W		S1WB(A)80	-7101	1.0	25	30	800	150	1.00	0.50	10	520	-	-
1W		 S2WB(A)80	-7101	2.0	112 *	50	800	-40 to 150	1.05	1.00	10	520	-	-

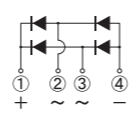

 : New product * : TI

BRIDGE DIODES

SIP (Single In-line Package) Bridge Diodes





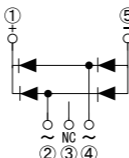



































THD (Through Hole Device)							Remarks
Package	JEDEC Code JEITA Code House Name	Fig.	IF(AV) [A]	VRRM [V]			
				600	800	1000	
 24.0 × 13.8 × 3.1(mm)	— — D3K	D1	2		UD2KB80		
			3		UD3KB80		
			4		UD4KB80		
			6		UD6KBA80		
 24.5 × 20.0 × 3.5(mm)	— — 2S	D2	1.5	D2SBA60 D2SB60			
			2	D2SB60A			
 25.2 × 25.0 × 4.2(mm)	— — JB	D5	6	D6JBB60V	D6JBB80V		
			8	D8JBB60V	D8JBB80V		
			10	D10JBB60V	D10JBB80V		
 32.5 × 25.0 × 4.6(mm)	— — 3S	D3	4	D3SBA60 D3SB60 D4SB60L	D3SB80 D4SB80		
			10	D10XB60 D10XB60H	D10XB80		
 29.4 × 29.0 × 4.6(mm)	— — JA	D6	15	D15JAB60V	D15JAB80V		
			25	D25JAB60V	D25JAB80V		
 37.5 × 30.0 × 4.6(mm)	— — 5S	D4	6	D5SBA60 D5SB60 D6SB60L	D5SB80 D6SB80		
			15	D15XB60 D15XB60H	D15XB80	D15XB100	
			20	D20XB60	D20XB80		
			25	D25XB60	D25XB80	D25XB100	
 47.0 × 45.7 × 7.5(mm)	— — TSB(4pin)	D7	50		D50XB80		
			50		D50JCB80V		
 47.0 × 45.7 × 7.5(mm)	— — JC(4pin)		50		D50JCB80V		

DIP (Dual In-line Package) Bridge Diode

Package	JEDEC Code JEITA Code House Name	Fig.	IF(AV) [A]	VRRM [V]			Remarks
				600	800	1000	
 47.0 × 45.7 × 7.5(mm)	— — JH	D10-1	70		 D70JHB80V		

 : New product

SIP (Single In-line Package) Bridge Diodes

THD (Through Hole Device)													
Package		Type No.	Absolute Maximum Ratings				Electrical Characteristics			Weight (mg)	UL	Automotive	
JEDEC Code JEITA Code House Name	Fig.		IF (AV) [A]	Conditions Tc [°C]	IFSM [A]	VRRM [V]	Tj [°C]	Vf (max) [V]	Conditions IF [A]				Ir (max) Vr=VRRM [μA]
— — D3K	D1	UD2KB80	2.0	143	62	800	150	1.05	1.00	10	1460		—
		UD3KB80	3.0	140	90	800	150	1.05	1.50	10	1460		—
		UD4KB80	4.0	138	135	800	150	1.00	2.00	10	1460		—
		UD6KBA80	6.0	131	135	800	150	1.05	3.00	10	1460		—
		UD8KBA80	8.0	126	165	800	150	1.05	4.00	10	1460		—
— — 2S	D2	D2SBA60	1.5	25 *1	60	600	150	1.05	0.75	10	2080	—	—
		D2SB60	1.5	25 *1	80	600	150	1.05	0.75	10	2080	—	—
		D2SB60A	2.0	115 *2	120	600	150	0.95	1.00	10	2080	—	—
— — JB	D5	D6JBB60V	6.0	131	100	600	150	1.05	3.00	10	2710		—
		D6JBB80V	6.0	131	100	800	150	1.05	3.00	10	2710		—
		D8JBB60V	8.0	130	130	600	150	1.05	4.00	10	2710		—
		D8JBB80V	8.0	130	130	800	150	1.05	4.00	10	2710		—
		D10JBB60V	10.0	129	150	600	150	1.05	5.00	10	2710		—
— — 3S	D3	D3SBA60	4.0	108	80	600	150	1.05	2.00	10	4080		—
		D3SB60	4.0	108	120	600	150	1.05	2.00	10	4080		—
		D4SB60L	4.0	111	150	600	150	0.95	2.00	10	4080		—
		D3SB80	4.0	108	120	800	150	1.05	2.00	10	4080		—
		D4SB80	4.0	108	150	800	150	0.95	2.00	10	4080		—
		D10XB60	10.0	100	120	600	150	1.10	5.00	10	4500		—
		D10XB60H	10.0	112	170	600	150	1.05	5.00	10	4500		—
		D10XB80	10.0	100	120	800	150	1.10	5.00	10	4500		—
		D15JAB60V	15.0	110	200	600	150	1.05	7.50	10	4490		—
		D15JAB80V	15.0	110	200	800	150	1.05	7.50	10	4490		—
— — JA	D6	D25JAB60V	25.0	107	350	600	150	1.05	12.50	10	4490		—
		D25JAB80V	25.0	107	350	800	150	1.05	12.50	10	4490		—
		D5SBA60	6.0	111	120	600	150	1.05	3.00	10	6540		—
		D5SB60	6.0	110	170	600	150	1.05	3.00	10	6540		—
		D6SB60L	6.0	112	170	600	150	1.05	3.00	10	6540		—
		D5SB80	6.0	110	170	800	150	1.05	3.00	10	6540		—
		D6SB80	6.0	110	170	800	150	1.05	3.00	10	6540		—
		D15XB60	15.0	100	200	600	150	1.10	7.50	10	7240		—
		D15XB60H	15.0	107	240	600	150	1.05	7.50	10	7240		—
		D15XB80	15.0	100	200	800	150	1.10	7.50	10	7240		—
		D15XB100	15.0	110	200	1000	150	1.10	7.50	10	7240		—
		D20XB60	20.0	87	240	600	150	1.10	10.00	10	7240		—
		D20XB80	20.0	87	240	800	150	1.10	10.00	10	7240		—
		D25XB60	25.0	98	350	600	150	1.05	12.50	10	7240		
D25XB80	25.0	98	350	800	150	1.05	12.50	10	7240				
D25XB100	25.0	106	350	1000	150	1.05	12.50	10	7240		—		
— — TSB(4pin)	D7	D50XB80	50.0	95	600	800	150	1.05	25.00	10	20000		—
		D50JCB80V	50.0	94	600	800	150	1.05	25.00	10	20000		

*1 : Ta *2 : Tl  : Please contact us.  : UL recognized (UL File No.E142422)







DIP (Dual In-line Package) Bridge Diode

THD (Through Hole Device)													
Package		Type No.	Absolute Maximum Ratings				Electrical Characteristics			Weight (mg)	UL	Automotive	
JEDEC Code JEITA Code House Name	Fig.		IF (AV) [A]	Conditions Tc [°C]	IFSM [A]	VRRM [V]	Tj [°C]	Vf (max) [V]	Conditions IF [A]				Ir (max) Vr=VRRM [μA]
— — JH	D10-1	 D70JHB80V	70	99	500	800	-55 to 150	1.1	35	10	30600	—	—

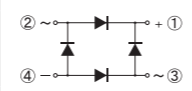



 : New product

BRIDGE DIODES



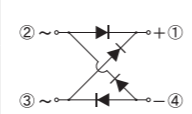

SQIP (Square In-line Package) Bridge Diodes

Package	JEDEC Code JEITA Code House Name	Fig.	I _{F(AV)} [A]	V _{RRM} [V]			Remarks
				600	800	1000	
 13.0 × 13.0 × 27.5(mm)	— S2VB	E3	2	S2VB60			
 17.0 × 17.0 × 32.5(mm)	— S4VB	E4	4	S4VB60			
 25.0 × 25.0 × 32.5(mm)	— S5VB	E5	6	S5VB60			
 22.0 × 22.0 × 32.5(mm)	— S10VB	E6	10	S10VB60			
 26.5 × 26.5 × 25.0(mm)	— S15VB	E7	15	S15VB60			
 32.0 × 32.0 × 25.0(mm)	— S25VB	E8	25	S25VB60	S25VB80		
 36.0 × 36.0 × 24.0(mm)	— S50VB	E9	50	S50VB60	S50VB80		

Input/Output In-line Terminal Type

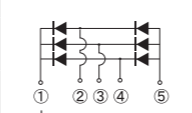
Package	JEDEC Code JEITA Code House Name	Fig.	I _{F(AV)} [A]	V _{RRM} [V]			Remarks
				600	800	1000	
 17.0 × 17.0 × 31.0(mm)	— S3WB	E10	2.3	S3WB60			
 22.5 × 22.5 × 32.5(mm)	— S10WB	E11	10	S10WB60			
 26.5 × 26.5 × 32.5(mm)	— S15WB	E12	15	S15WB60			
 32.5 × 32.5 × 32.5(mm)	— S20WB	E13	20	S20WB60	S20WB80		

3 Phase Bridge Diodes

Package	JEDEC Code JEITA Code House Name	Fig.	I _{F(AV)} [A]	V _{RRM} [V]			Remarks
				800	1200	1600	
 47.0 × 45.7 × 7.5(mm)	— TSB(5pin)	D8	30	D30XT80			
			45	D45XT80		D45XT160	
 47.0 × 45.7 × 7.5(mm)	— JC(5pin)		30		D30JCT120V		
			45		D45JCT120V	 D45JCT160V	
 47.0 × 45.7 × 7.5(mm)	— JF	D9	75	D75JFT80V			

 : New product  : UL recognized (UL File No.E142422)

SQIP (Square In-line Package) Bridge Diodes

Package		Type No.	Absolute Maximum Ratings				Electrical Characteristics			Weight (mg)	UL	Automotive	
JEDEC Code JEITA Code House Name	Fig.		I _{F(AV)} [A]	Conditions T _C [°C]	I _{FSM} [A]	V _{RRM} [V]	T _J [°C]	V _F (max) [V]	Conditions I _F [A]				I _R (max) V _R =V _{RRM} [μA]
— S2VB	E3	S2VB60	2 *1	40	40	600	150	1.05	1.0	10	3000	—	—
— S4VB	E4	S4VB60	4	40	80	600	150	1.05	2.0	10	5200	—	—
— S5VB	E5	S5VB60	6	40	200	600	150	1.05	3.0	10	9100	—	—
— S10VB	E6	S10VB60	10	40	200	600	150	1.05	5.0	10	8000	—	—
— S15VB	E7	S15VB60	15	83 *2	200	600	150	1.05	7.5	10	16200	—	—
— S25VB	E8	S25VB60	25	85 *2	400	600	150	1.05	12.5	10	21000	—	—
		S25VB80	25	85 *2	400	800	150	1.05	12.5	10	21000	—	—
— S50VB	E9	S50VB60	50	95 *2	500	600	150	1.05	25.0	10	28000	—	—
		S50VB80	50	95 *2	500	800	150	1.05	25.0	10	28000		—

*1 : Without heatsink *2 : T_C  : UL recognized (UL File No.E142422)

Input/Output In-line Terminal Type

Package		Type No.	Absolute Maximum Ratings				Electrical Characteristics			Weight (mg)	UL	Automotive	
JEDEC Code JEITA Code House Name	Fig.		I _{F(AV)} [A]	Conditions T _C [°C]	I _{FSM} [A]	V _{RRM} [V]	T _J [°C]	V _F (max) [V]	Conditions I _F [A]				I _R (max) V _R =V _{RRM} [μA]
— S3WB	E10	S3WB60	2.3	40 *	120	600	150	1.05	2.0	10	5100	—	—
— S10WB	E11	S10WB60	10.0	74	170	600	150	1.05	5.0	10	9000	—	—
— S15WB	E12	S15WB60	15.0	77	200	600	150	1.05	7.5	10	16200	—	—
— S20WB	E13	S20WB60	20.0	76	500	600	150	1.05	10.0	10	20500	—	—
		S20WB80	20.0	76	500	800	150	1.05	10.0	10	20500		—

* : T_a  : UL recognized (UL File No.E142422)

3 Phase Bridge Diodes

THD (Through Hole Device)







Package		Type No.	Absolute Maximum Ratings				Electrical Characteristics			Weight (mg)	UL	Automotive	
JEDEC Code JEITA Code House Name	Fig.		I _{F(AV)} [A]	Conditions T _C [°C]	I _{FSM} [A]	V _{RRM} [V]	T _J [°C]	V _F (max) [V]	Conditions I _F [A]				I _R (max) V _R =V _{RRM} [μA]
— TSB(5pin)	D8	D30XT80	30	117	300	800	150	1.05	10	10	20000		—
		D45XT80	45	101	400	800	150	1.05	15	10	20000		—
		D45XT160	45	97	330	1600	150	1.05	15	100	20000		—
— JC(5pin)	D8	D30JCT120V	30	116	300	1200	150	1.05	10	10	20000		—
		D45JCT120V	45	99	450	1200	150	1.05	15	10	20000		—
— JF	D9	D75JFT80V	75	109	400	800	150	1.05	25	10	24880	—	—

 : New product  : UL recognized (UL File No.E142422)

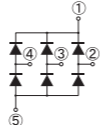
BRIDGE DIODES

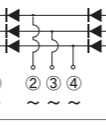

Series	Feature
S	Balanced VF and Ir
N	Low VF, High Voltage
K	Low VF

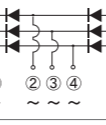
3 Phase Bridge Diodes

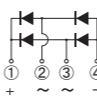

Package	JEDEC Code JEITA Code House Name	Fig.	IF(AV) [A]	VRRM [V]			Remarks
				600	800	1600	
 36.0 × 36.0 × 24.0(mm)	— — SVT	E15	10	S10VT60	S10VT80		
			15	S15VT60	S15VT80		
			20	S20VT60	S20VT80		
			30	S30VT60	S30VT80	S30VT160	
			10	S10VTA60	S10VTA80		
			15	S15VTA60	S15VTA80		
 36.0 × 36.0 × 23.0(mm)	— — SVTA	E14	10	S10VTA60	S10VTA80		
			15	S15VTA60	S15VTA80		
			20	S20VTA60	S20VTA80		
 47.0 × 45.7 × 7.5(mm)	— — JH	D10-2	100	 D100JHT80V	 D100JHT120V	 D100JHT160V	

 : New product  : Under development

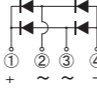

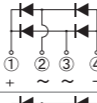

High Speed Bridge Diodes (SBD)

THD (Through Hole Device)							
Package	JEDEC Code JEITA Code House Name	Fig.	IF(AV) [A]	VRRM [V]			Remarks
				40	60	200	
 32.5 × 25.0 × 4.6(mm)	— — 3S	D3	4	D4SBS4	D4SBS6	D4SBN20	
			10	D10SBS4			
			15		D15XBS6		
 37.5 × 30.0 × 4.6(mm)	— — 5S	D4	6			D6SBN20	
			15			D15XBN20	
			20		D20XBS6		
			30			D30XBN20	

High Speed Bridge Diodes (FRD)

THD (Through Hole Device)							
Package	JEDEC Code JEITA Code House Name	Fig.	IF(AV) [A]	VRRM [V]			Remarks
				200	400	1000	
 32.5 × 25.0 × 4.6(mm)	— — 3S	D3	4	D4SBL20U	D4SBL40		
 47.0 × 45.7 × 7.5(mm)	— — JC(4pin)	D7	30			D30JCB100K	

3 Phase Bridge Diodes

Package		Type No.	Absolute Maximum Ratings				Electrical Characteristics			Weight (mg)	UL	Automotive	
JEDEC Code JEITA Code House Name	Fig.		IF (AV) [A]	Conditions Tc [°C]	IFSM [A]	VRRM [V]	Tj [°C]	VF (max) [V]	Conditions IF [A]				Ir (max) Vr=VRRM [μA]
— — SVT	E15	S10VT60	10	137	170	600	150	1.05	3.5	10	31000	—	—
		S10VT80	10	137	150	800	150	1.05	3.5	10	31000	—	—
		S15VT60	15	132	200	600	150	1.05	5.0	10	31000	—	—
		S15VT80	15	132	200	800	150	1.05	5.0	10	31000	—	—
		S20VT60	20	128	300	600	150	1.05	7.0	10	31000	—	—
		S20VT80	20	128	300	800	150	1.05	7.0	10	31000	—	—
		S30VT60	30	121	400	600	150	1.05	10.0	10	31000	—	—
		S30VT80	30	121	400	800	150	1.05	10.0	10	31000		—
		S30VT160	30	116	350	1600	150	1.05	10.0	100	31000	—	—
— — SVTA	E14	S10VTA60	10	137	170	600	150	1.05	3.5	10	30000	—	—
		S10VTA80	10	137	150	800	150	1.05	3.5	10	30000	—	—
		S15VTA60	15	132	200	600	150	1.05	5.0	10	30000	—	—
		S15VTA80	15	132	200	800	150	1.05	5.0	10	30000	—	—
		S20VTA60	20	128	300	600	150	1.05	7.0	10	30000	—	—
		S20VTA80	20	128	300	800	150	1.05	7.0	10	30000	—	—
		S30VTA60	30	121	400	600	150	1.05	10.0	10	30000	—	—
		S30VTA80	30	121	400	800	150	1.05	10.0	10	30000	—	—
		S30VTA160	30	116	350	1600	150	1.05	10.0	100	30000	—	—
— — JH	D10-2	 D100JHT80V	100	99	500	800	-55 to 150	1.10	35	10	31400	—	—
		 D100JHT120V	100	92	450	1200	-55 to 150	1.17	35	10	31400	—	—
		 D100JHT160V	100	92	540	1600	-55 to 150	1.15	35	10	31400	—	—

 : New product  : Under development  : UL recognized (UL File No.E142422)

High Speed Bridge Diodes (SBD)

THD (Through Hole Device)														
Package		Type No.	Absolute Maximum Ratings				Electrical Characteristics			Weight (mg)	UL	Automotive	Remarks	
JEDEC Code JEITA Code House Name	Fig.		IF (AV) [A]	Conditions Tc [°C]	IFSM [A]	VRRM [V]	Tj [°C]	VF (max) [V]	Conditions IF [A]					Ir (max) Vr=VRRM [μA]
— — 3S	D3	D4SBS4	4	116	60	40	150	0.55	2.0	2mA	3920	—	—	S series
		D4SBS6	4	114	60	60	150	0.62	2.0	2mA	3920	—	—	S series
		D4SBN20	4	103	60	200	150	0.90	2.0	1.5	3910	—	—	N series
		D10SBS4	10	67	100	40	150	0.55	5.0	3.5mA	3920	—	—	S series
		D15XBS6	15	59	150	60	150	0.63	7.5	6.0mA	4360	—	—	S series
— — 5S	D4	D6SBN20	6	110	120	200	150	0.90	3.0	2	6800	—	—	N series
		D15XBN20	15	106	200	200	150	0.90	7.5	5	7500	—	—	N series
		D20XBS6	20	100	200	60	150	0.63	10.0	8.0mA	7500	—	—	S series
		D30XBN20	30	91	350	200	150	0.90	15.0	10	7500	—	—	N series

High Speed Bridge Diodes (FRD)

THD (Through Hole Device)														
Package		Type No.	Absolute Maximum Ratings				Electrical Characteristics			Weight (mg)	UL	Automotive	Remarks	
JEDEC Code JEITA Code House Name	Fig.		IF (AV) [A]	Conditions Tc [°C]	IFSM [A]	VRRM [V]	Tj [°C]	VF (max) [V]	Conditions IF [A]					Ir (max) Vr=VRRM [μA]
— — 3S	D3	D4SBL20U	4	108	80	200	150	0.98	2.0	10	4080	—	—	
		D4SBL40	4	91	50	400	150	1.30	2.5	10	3920	—	—	
— — JC(4pin)	D7	D30JCB100K	30	90	450	1000	150	1.90	15.0	10	20000		○	K series

 : UL recognized (UL File No.E142422)



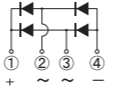

BRIDGE DIODES

Low Vf Bridge Diodes

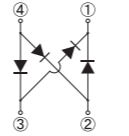
THD (Through Hole Device)							
Package	JEDEC Code JEITA Code House Name	Fig.	I _{F(AV)} [A]	V _{RRM} [V]			Remarks
				600	800	1000	
 37.5 × 30.0 × 4.6(mm)	— — 5S	D4	15	LL15XB60			
			25	LL25XB60	★ LL25XB80F		
			★ : Under development				

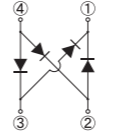
Low Noise Bridge Diodes

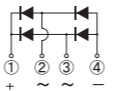
Surface Mount							
Package	JEDEC Code JEITA Code House Name	Fig.	I _{F(AV)} [A]	V _{RRM} [V]			Remarks
				600	800	1000	
 10.6 × 10.2 × 3.1(mm)	— — 1W	C8	1.1	LN1WBA60			

THD (Through Hole Device)							
Package	JEDEC Code JEITA Code House Name	Fig.	I _{F(AV)} [A]	V _{RRM} [V]			Remarks
				600	800	1000	
 6.2 × 10.2 × 3.0(mm)	— — 1W	C9	1.1	LN1WBA60			
 32.5 × 25.0 × 4.6(mm)	— — 3S	D3	4	LN4SB60			
 37.5 × 30.0 × 4.6(mm)	— — 5S	D4	6	LN6SB60			
			15	LN15XB60 LN15XB60H			
			25	LN25XB60			

Low Vf Bridge Diodes

THD (Through Hole Device)														
Package		Type No.	Absolute Maximum Ratings					Electrical Characteristics				Weight (mg)	UL	Automotive
JEDEC Code JEITA Code House Name	Fig.		I _{F(AV)} [A]	Conditions T _c [°C]	I _{FSM} [A]	V _{RRM} [V]	T _j [°C]	V _F (max) [V]	Conditions I _F [A]	I _r (max) V _R =V _{RRM} [μA]	t _{rr} (max) [μs]			
— — 5S	D4	LL15XB60	15	124	200	600	150	0.90	7.5	10	3	7500	UL	—
		LL25XB60	25	113	300	600	150	0.92	12.5	10	3	7500	UL	■
		★ LL25XB80F	25	— *1	300 *	800	-55 to 150	0.95	12.5	10	— *1	—	—	—

★ : Under development * : Tentative *1 : Under evaluation ■ : Please contact us. UL : UL recognized (UL File No.E142422)





Low Noise Bridge Diodes

Surface Mount-THD (Through Hole Device)															
Package		Type No.	Absolute Maximum Ratings					Electrical Characteristics				Weight (mg)	UL	Automotive	Remarks
JEDEC Code JEITA Code House Name	Fig.		I _{F(AV)} [A]	Conditions T _c [°C]	I _{FSM} [A]	V _{RRM} [V]	T _j [°C]	V _F (max) [V]	Conditions I _F [A]	I _r (max) V _R =V _{RRM} [μA]	t _{rr} (max) [μs]				
— — 1W	C8(SMD) C9(DIP)	LN1WBA60	1.1	25 *	50	600	150	1.00	0.55	10	5	520	—	—	SMD-7072 DIP-7101
— — 3S	D3	LN4SB60	4.0	111	150	600	150	0.95	2.00	10	5	4080	UL	—	
— — 5S	D4	LN6SB60	6.0	111	170	600	150	1.05	3.00	10	5	7240	UL	—	
		LN15XB60	15.0	100	200	600	150	1.10	7.50	10	5	7240	—	—	
		LN15XB60H	15.0	106	290	600	150	1.05	7.50	10	5	7240	—	—	
		LN25XB60	25.0	85	350	600	150	1.05	12.50	10	5	7240	—	—	



* : Ta UL : UL recognized (UL File No.E142422)

SCHOTTKY BARRIER DIODES

Single

Package	JEDEC Code JEITA Code House Name	Fig.	I _{F(AV)} [A]	V _{RRM} [V]		Remarks
				40	60	
 3.0 × φ 2.6(mm)	— — AX057	A1	1	D1NS4	D1NS6	
 5.0 × φ 4.0(mm)	— — AX078	A4-1	2	D2S4M	D2S6M	
 7.0 × φ 4.4(mm)	— — AX14	A7	3	D3S4M	D3S6M	

Two Terminal Type

Package	JEDEC Code JEITA Code House Name	Fig.	I _{F(AV)} [A]	V _{RRM} [V]				Remarks
				40	60	90	150	
 28.5 × 10.0 × 4.5(mm)	— SC-91 FTO-220G	J4	5	SG5S4M	SG5S6M	SG5S9M		

Three Terminal Type

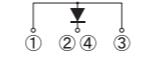
Package	JEDEC Code JEITA Code House Name	Fig.	I _{F(AV)} [A]	V _{RRM} [V]				Remarks
				40	60	90	150	
 41.0 × 16.0 × 5.0(mm)	TO-247AD — MTO-3PV	K7-2	40				S40T15V	
			90				S90T15V	

Single

Package		Type No.	Absolute Maximum Ratings					Electrical Characteristics				Weight (mg)	Based on AEC-Q101	Automotive	Series
JEDEC Code JEITA Code House Name	Fig.		V _{RRM} [V]	I _{F(AV)} [A]	Conditions T _a [°C]	I _{FSM} [A]	T _j [°C]	V _F (max) [V]	Conditions I _F [A]	I _r (max) V _R =V _{RRM} [mA]	C _t (typ) [pF]				
— — AX057	A1	D1NS4	40	1	59	30	150	0.55	1	0.8	50	185	—	—	S series
— — AX078	A4-1	D1NS6	60	1	46	30	150	0.58	1	1.0	53	185	—	—	S series
— — —	A7	D2S4M	40	2	122 *1	60	150	0.55	2	2.0	95	400	—	—	S series
— — —		D2S6M	60	2	119 *1	60	150	0.58	2	2.0	90	400	—	—	S series
— — —	A7	D3S4M	40	3	63	80	150	0.55	3	3.5	150	1060	—	—	S series
— — —		D3S6M	60	3	133 *1	80	150	0.58	3	2.5	130	1060	—	—	S series

*1 : Tl

Two Terminal Type

Package		Type No.	Absolute Maximum Ratings					Electrical Characteristics				Weight (mg)	Based on AEC-Q101	Automotive	Series
JEDEC Code JEITA Code House Name	Fig.		V _{RRM} [V]	I _{F(AV)} [A]	Conditions T _c [°C]	I _{FSM} [A]	T _j [°C]	V _F (max) [V]	Conditions I _F [A]	I _r (max) V _R =V _{RRM} [mA]	C _t (typ) [pF]				
— — SC-91 FTO-220G	J4	SG5S4M	40	5	131	150	150	0.52	5	0.5	157	1580	—	—	S series
		SG5S6M	60	5	130	120	150	0.56	5	0.5	165	1580	—	—	S series
		SG5S9M	90	5	124	90	150	0.75	5	0.5	140	1580	—	—	S series





Three Terminal Type

Package		Type No.	Absolute Maximum Ratings					Electrical Characteristics				Weight (mg)	Based on AEC-Q101	Automotive	Series
JEDEC Code JEITA Code House Name	Fig.		V _{RRM} [V]	I _{F(AV)} [A]	Conditions T _c [°C]	I _{FSM} [A]	T _j [°C]	V _F (max) [V]	Conditions I _F [A]	I _r (max) V _R =V _{RRM} [mA]	C _t (typ) [pF]				
TO-247AD — MTO-3PV	K7-2	S40T15V	150	40	131	700	150	0.92	40	0.12	595	6190	—	○	N series
		S90T15V	150	90	122	1400	150	0.95	90	0.35	1690	6230	—	○	N series

Refer to P21 for the features of the series.

SCHOTTKY BARRIER DIODES

Center Tap, Common Cathode

Surface Mount											Remarks	
Package	JEDEC Code JEITA Code House Name	Fig.	IF (AV) [A]	VRRM[V]								
				30	40	60	90	100	120	150		
 9.5 × 6.6 × 2.65(mm)	— SC-63 E-pack	G1-1	5	DE5PC3 DE5SC3ML	DE5SC4M	DE5SC6M						
			10	DE10PC3 DE10SC3L	DE10SC4							
 9.5 × 6.6 × 2.65(mm)	TO-252AB similar SC-63 FE	G3-1	6		D6FEC4ST			D6FEC10ST	D6FEC12ST	D6FEC15ST		
 13.2 × 10.2 × 4.7(mm)	— SC-83 similar STO-220	H1-1	10		DF10SC4M	DF10SC6	DF10SC9				DF10NC15	
			15		DF15SC4M			DF15JC10			DF15NC15	
			20	DF20PC3M	DF20SC4M		DF20SC9M	DF20JC10		DF20NC15		
			25			DF25SC6M						
			30	DF30PC3M DF30SC3ML	DF30JC4 DF30SC4M	DF30JC6		DF30JC10		DF30NC15		
 13.2 × 10.2 × 4.6(mm)	— SC-83 similar FD	H2-2	10								D10FDC10ST	
			20								D20FDC10ST	D20FDC15ST
			30		D30FDC4S					D30FDC10ST		D30FDC15ST
			40							D40FDC10ST		D40FDC15ST

Refer to P27 for Three Terminal Type.

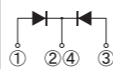







Center Tap, Common Cathode

Surface Mount																
JEDEC Code JEITA Code House Name	Fig.	Type No.	Absolute Maximum Ratings					Electrical Characteristics					Weight (mg)	Based on AEC-Q101	Automotive	Series
			VRRM [V]	IF (AV) [A]	Conditions Tc [°C]	IFSM [A]	Tj [°C]	Vf (max) [V]	Conditions IF [A]	Ir (max) VR=VRRM [mA]	Ct (typ) [pF]					
— SC-63 E-pack	G1-1	DE5PC3	30	5	90	90	125	0.4	2.5	6	180	310	—	—	P series	
		DE5SC3ML	30	5	110	90	150	0.45	2.5	3.5	190	310	—	■	S series	
		DE5SC4M	40	5	101	80	150	0.55	2.5	3.5	150	310	—	■	S series	
		DE5SC6M	60	5	92	80	150	0.58	2.5	2.5	130	310	—	■	S series	
		DE10PC3	30	10	97	80	125	0.4	4	10	290	310	—	—	P series	
		DE10SC3L	30	10	124	100	150	0.45	4	5	290	310	—	■	S series	
TO-252AB similar SC-63 FE	G3-1	DE10SC4	40	10	132	100	150	0.55	5	3.5	210	310	—	■	S series	
		D6FEC4ST	40	6	158	90	175	0.74	3	8μA	93	310	○	○	SL series	
		D6FEC10ST	100	6	154	100	175	0.86	3	8μA	60	310	○	○	SL series	
		D6FEC12ST	120	6	154	100	175	0.87	3	8μA	60	310	○	○	SL series	
		D6FEC15ST	150	6	154	100	175	0.88	3	8μA	52	310	○	○	SL series	
		— SC-83 similar STO-220	H1-1	DF10SC4M	40	10	125	100	150	0.55	5	3.5	180	1420	—	—
DF10SC6	60			10	132	150	150	0.58	5	4.5	260	1420	—	—	S series	
DF10SC9	90			10	131	150	150	0.75	5	3	185	1420	—	—	S series	
DF10NC15	150			10	123	100	150	0.88	5	0.2	110	1420	—	—	N series	
DF15SC4M	40			15	129	150	150	0.55	7.5	5	340	1420	—	—	S series	
DF15JC10	100			15	126	150	150	0.86	7.5	0.6	200	1420	—	—	J series	
DF15NC15	150			15	126	150	150	0.88	7.5	0.3	155	1420	—	—	N series	
DF20PC3M	30			20	105	200	125	0.4	8	35	560	1420	—	—	P series	
DF20SC4M	40			20	122	230	150	0.55	10	7.5	390	1420	—	—	S series	
DF20SC9M	90			20	111	200	150	0.75	10	10	370	1420	—	—	S series	
DF20JC10	100			20	121	200	150	0.86	10	0.7	260	1420	—	—	J series	
DF20NC15	150			20	121	200	150	0.88	10	0.4	200	1420	—	—	N series	
DF25SC6M	60			25	115	300	150	0.58	12.5	10	490	1420	—	—	S series	
DF30PC3M	30			30	97	300	125	0.4	10	50	840	1420	—	—	S series	
DF30SC3ML	30			30	119	350	150	0.48	15	10	820	1420	—	—	S series	
DF30JC4	40			30	115	250	150	0.61	15	0.7	560	1420	—	—	J series	
DF30SC4M	40			30	112	360	150	0.55	15	10	590	1420	—	—	S series	
DF30JC6	60			30	108	250	150	0.69	15	0.7	490	1420	—	—	J series	
DF30JC10	100			30	116	300	150	0.86	15	1	390	1420	—	—	J series	
DF30NC15	150			30	115	300	150	0.88	15	0.5	300	1420	—	—	N series	
DF40PC3	30			40	105	350	125	0.4	15	45	1160	1420	—	—	P series	
DF40SC3L	30			40	112	400	150	0.45	15	17	1200	1420	—	—	S series	
DF40SC4	40			40	106	350	150	0.55	20	14	860	1420	—	—	S series	
— SC-83 similar FD	H2-2			D10FDC10ST	100	10	158	150	175	0.86	5	15μA	104	1430	○	○
		D20FDC10ST	100	20	119	250	150	0.86	10	30μA	185	1440	○	○	N series	
		D20FDC15ST	150	20	118	250	150	0.88	10	30μA	159	1440	—	○	N series	
		D30FDC4S	40	30	114	300	150	0.55	15	1.5	415	1440	○	○	S series	
		D30FDC10ST	100	30	108	300	150	0.86	15	40μA	242	1440	—	○	N series	
		D30FDC15ST	150	30	107	300	150	0.88	15	40μA	209	1440	—	○	N series	
		D40FDC10ST	100	40	105	400	150	0.86	20	60μA	360	1440	—	○	N series	
		D40FDC15ST	150	40	103	400	150	0.88	20	60μA	315	1440	—	○	N series	

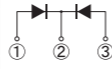
■ : Please contact us. Refer to P21 for the features of the series.

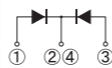
SCHOTTKY BARRIER DIODES

Center Tap, Common Cathode

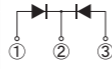
Three Terminal Type														
Package	JEDEC Code JEITA Code House Name	Fig.	IF (AV) [A]	VRRM[V]								Remarks		
				15	30	40	60	90	100	120	150		600	
 28.5 × 10.0 × 4.5(mm)	— SC-91 FTO-220G	J9	8			SG8SC4M								
			10		SG10SC3LM	SG10SC4M	SG10SC6M	SG10SC9M				SG10TC15M		
			15		SG15SC4M	SG15SC6M								
			20		SG20SC3LM	SG20SC4M	SG20JC6M SG20SC6M	SG20SC9M	SG20TC10M	SG20TC12M	SG20TC15M			
			30		SG30SC3LM	SG30SC4M	SG30JC6M SG30SC6M		SG30TC10M	SG30TC12M	SG30TC15M			
 41.0 × 16.0 × 5.0(mm)	TO-247AD — MTO-3PT	K5-2	20					S20SC9MT						
			30			S30SC4MT	S30SC6MT				S30TC15T			
			40	S40HC1R5T										
 41.0 × 16.0 × 5.0(mm)	TO-247AD — MTO-3PV	K7-1	60							S60JC10V				
			30											
 40.0 × 15.0 × 5.5(mm)	— SC-93 ITO-3P	K3-1	20					D20SC9M						
			25					D25SC6M						
			30				D30SC4M							

Refer to P25 for Surface Mount.

Center Tap, Common Anode

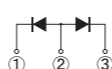
Three Terminal Type												
Package	JEDEC Code JEITA Code House Name	Fig.	IF (AV) [A]	VRRM[V]								Remarks
				15	30	40	60	90	100	120	150	
 40.0 × 15.0 × 5.5(mm)	— SC-93 ITO-3P	K3-2	25					D25SC6MR				

Center Tap, Common Cathode

Three Terminal Type															
Package		Type No.	Absolute Maximum Ratings					Electrical Characteristics				Weight (mg)	Based on AEC-Q101	Automotive	Series
JEDEC Code JEITA Code House Name	Fig.		VRRM [V]	IF (AV) [A]	Conditions Tc [°C]	IFSM [A]	Tj [°C]	Vf (max) [V]	Conditions IF [A]	Ir (max) VR=VRRM [mA]	Ct (typ) [pF]				
— SC-91 FTO-220G	J9	SG8SC4M	40	8	155	80	175	0.56	4.0	0.3	100	1580	—	—	S series
		SG10SC3LM	30	10	136	150	150	0.45	4.0	5.0	310	1580	—	—	S series
		SG10SC4M	40	10	150	150	175	0.52	5.0	0.5	157	1580	—	—	S series
		SG10SC6M	60	10	145	140	175	0.56	5.0	0.5	165	1580	—	—	S series
		SG10SC9M	90	10	139	150	175	0.75	5.0	0.5	140	1580	—	—	S series
		SG10TC15M	150	10	153	120	175	0.88	5.0	15μA	92	1580	—	—	SL series
		SG15SC4M	40	15	117	150	150	0.52	7.5	0.8	230	1580	—	—	S series
		SG15SC6M	60	15	113	180	150	0.61	7.5	0.6	185	1580	—	—	S series
		SG20SC3LM	30	20	124	250	150	0.45	8.0	9.0	570	1580	—	—	S series
		SG20SC4M	40	20	115	200	150	0.52	10.0	1.1	315	1580	—	—	S series
		SG20JC6M	60	20	106	200	150	0.69	10.0	0.1	250	1580	—	—	J series
		SG20SC6M	60	20	107	200	150	0.61	10.0	0.8	250	1580	—	—	S series
		SG20SC9M	90	20	112	200	150	0.75	10.0	1.0	245	1580	—	—	S series
		SG20TC10M	100	20	140	200	175	0.86	10.0	30μA	185	1580	—	—	SL series
		SG20TC12M	120	20	137	200	175	0.87	10.0	30μA	175	1580	—	—	SL series
		SG20TC15M	150	20	136	200	175	0.88	10.0	30μA	159	1580	—	—	SL series
		SG30SC3LM	30	30	117	350	150	0.45	12.5	15.0	960	1580	—	—	M series
		SG30SC4M	40	30	101	300	150	0.55	15.0	1.5	415	1580	—	—	S series
		SG30JC6M	60	30	90	250	150	0.69	15.0	0.15	325	1580	—	—	J series
		SG30SC6M	60	30	100	300	150	0.61	15.0	1.2	385	1580	—	—	S series
		SG30TC10M	100	30	126	300	175	0.86	15.0	40μA	242	1580	—	—	SL series
		SG30TC12M	120	30	122	300	175	0.87	15.0	40μA	228	1580	—	—	SL series
		SG30TC15M	150	30	122	300	175	0.88	15.0	40μA	209	1580	—	—	SL series
		SG40TC10M	100	40	116	350	175	0.86	20.0	60μA	362	1580	—	—	SL series
		SG40TC12M	120	40	112	350	175	0.87	20.0	60μA	336	1580	—	—	SL series
		TO-247AD — MTO-3PT	K5-2	S20SC9MT	90	20	136	200	150	0.75	10.0	1.0	245	5130	—
S30SC4MT	40			30	132	300	150	0.55	15.0	1.5	410	5130	—	—	S series
S30SC6MT	60			30	129	300	150	0.61	15.0	1.2	385	5130	—	—	S series
S30TC15T	150			30	128	300	150	0.88	15.0	40μA	209	5130	—	—	N series
S40HC1R5T	15			40	111	450	125	0.41	20.0	10.0	960	5130	—	—	H series
S60HC1R5T	15			60	110	600	125	0.41	30.0	15.0	1400	5130	—	—	H series
S60HC3T	30			60	112	650	125	0.40	30.0	20.0	1100	5130	—	—	H series
S60SC3LT	30			60	138	650	150	0.48	30.0	25.0	1600	5130	—	—	S series
S60SC4MT	40			60	127	500	150	0.55	30.0	3.0	790	5130	—	—	S series
S60SC6MT	60			60	121	470	150	0.67	30.0	2.0	640	5130	—	—	S series
TO-247AD — MTO-3PV	K7-1	S60JC10V	100	60	118	500	150	0.95	30.0	0.2	695	6150	—	○	J series
— SC-93 ITO-3P	K3-1	D20SC9M	90	20	111	200	125	0.75	10.0	10.0	370	4350	—	—	S series
		D25SC6M	60	25	117	300	150	0.58	12.5	10.0	490	4350	—	—	S series
		D30SC4M	40	30	112	300	150	0.55	15.0	10.0	590	4350	—	—	S series

Center Tap, Common Anode

Three Terminal Type															
Package		Type No.	Absolute Maximum Ratings					Electrical Characteristics				Weight (mg)	Based on AEC-Q101	Automotive	Series
JEDEC Code JEITA Code House Name	Fig.		VRRM [V]	IF (AV) [A]	Conditions Tc [°C]	IFSM [A]	Tj [°C]	Vf (max) [V]	Conditions IF [A]	Ir (max) VR=VRRM [mA]	Ct (typ) [pF]				
— SC-93 ITO-3P	K3-2	D25SC6MR	60	25	117	300	150	0.58	12.5	10	490	4350	—	—	S series



Refer to P21 for the features of the series.

SCHOTTKY BARRIER DIODES

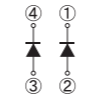
Array

Surface Mount						
Package	JEDEC Code JEITA Code House Name	Fig.	I _{F(AV)} [A]	V _{RRM} [V]		Remarks
				40	60	
 7.0 × 4.7 × 2.6(mm)	TO-269AA — 1Z	C2-2	1.2	S1ZAS4		

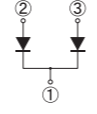
Diode Module

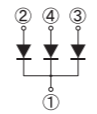
Package	JEDEC Code JEITA Code House Name	Fig.	I _{F(AV)} [A]	V _{RRM} [V]		Remarks
				40	60	
 43.0 × 27.0 × 21.0(mm)	— — Module	F1	120	D120SC4M	D120SC6M	
			240	D240SC4M	D240SC6M	
 43.0 × 27.0 × 21.0(mm)		F3-1	180	D180SC4M	D180SC6M	
				360	D360SC4M	

Array

Surface Mount															
Package		Type No.	Absolute Maximum Ratings					Electrical Characteristics				Weight (mg)	Based on AEC-Q101	Automotive	Series
JEDEC Code JEITA Code House Name	Fig.		V _{RRM} [V]	I _{F(AV)} [A]	Conditions T _c [°C]	I _{FSM} [A]	T _j [°C]	V _F (max) [V]	Conditions I _F [A]	I _R (max) V _R =V _{RRM} [mA]	C _t (typ) [pF]				
TO-269AA — 1Z	C2-2	S1ZAS4	40	1.2	47	40	150	0.55	1	1	65	130	—	—	S series

Diode Module

Surface Mount															
Package		Type No.	Absolute Maximum Ratings					Electrical Characteristics				Weight (mg)	Based on AEC-Q101	Automotive	Series
JEDEC Code JEITA Code House Name	Fig.		V _{RRM} [V]	I _{F(AV)} [A]	Conditions T _c [°C]	I _{FSM} [A]	T _j [°C]	V _F (max) [V]	Conditions I _F [A]	I _R (max) V _R =V _{RRM} [mA]	C _t (typ) [pF]				
— — Module	F1	D120SC4M	40	120	90	800	125	0.58	60	40	2.1	61000	—	—	S series
		D120SC6M	60	120	85	800	125	0.67	60	40	2.2	61000	—	—	S series
		D240SC4M	40	240	77	1600	125	0.6	120	80	4.2	64000	—	—	S series
	F3-1	D240SC6M	60	240	71	1600	125	0.67	120	80	4.4	64000	—	—	S series
		D180SC4M	40	180	83	800	125	0.58	60	40	2.1	62000	—	—	S series
		D180SC6M	60	180	78	800	125	0.67	60	40	2.2	62000	—	—	S series
	D360SC4M	40	360	64	1600	125	0.6	120	80	4.2	66000	—	—	S series	
	D360SC6M	60	360	58	1600	125	0.67	120	80	4.4	66000	—	—	S series	

Refer to P21 for the features of the series.











FAST RECOVERY DIODES

Fast Recovery Diodes are high speed type PN junction rectifying devices.



These diodes for the switching of power supply are suitable for use in household appliances, OA apparatuses, and FA apparatuses.

Series	Feature
K	Low Vf
ML	Low Vf, Low trr, Soft Recovery Type
US	Ultra Fast, Soft Recovery Type

Single

Surface Mount												
Package	JEDEC Code JEITA Code House Name	Fig.	IF(AV) [A]	VRRM[V]						Remarks		
				200	400	600	700	1000	1200			
	DO-219AA similar M1F	B2	1			M1FK60					① → ← ②	
			1.1	M1FL20U								
			1.5		M1FL40U							
	DO-214AC 1F	B3-1	0.8			D1FK60	D1FK70				① → ← ②	
			1					D1FK100	D1FK120			
			1.1	D1FL20U								
	SC-110B CE	B5-1	3			D3CE20LUS		D3CE60K			① → ← ②	
	DO-214AA similar M2F	B6	1.5			M2FL20U					① → ← ②	
			3			M3FL20U						
	DO-214AA similar M2F	B9-1	1.3				D2FL40				① → ← ②	
			1.5			D2FL20U		D2FK60				
			2.1					D3FK60				
	SC-63 E-pack	G1-5	3	DE3L20UA	DE3L40A						① → ← ② ③ N.C.	
			5					DE5L60U	DE5L60A			
	TO-277A similar FY	G4	5								① → ← ②③	
	SC-83 similar STO-220	H1-2	8								① → ← ②③	
			10					DF8L60US				
			20					DF10L60				
	SC-83 similar FD	H2-1	8								① → ← ②③ ④ N.C.	
			20					D8FD60LUS				
			30					D20FD60LU				
	SC-83 similar FD	H2-1	8								① → ← ②③ ④ N.C.	
			20					D8FD60LUS				
			30					D20FD60LU				

■ : New product

Axial												
Package	JEDEC Code JEITA Code House Name	Fig.	IF(AV) [A]	VRRM[V]						Remarks		
				200	400	600	700	1000				
	AX057	A1	0.8			D1NF60					① → ← ②	
			1	D1NL20U	D1NL40U				D1NK100			
	AX078	A4-1	1.5			D2L20U					① → ← ②	
			2				D2L40U					
	AX10	A5-1	1.5			S2L20U		S2L60			① → ← ②	
			2				S2L40U			S2K100		
	AX14	A7	2.2					S3L60			① → ← ②	
			3	S3L20U	S3L40U	S3K60						

Single

Surface Mount																
JEDEC Code JEITA Code House Name	Fig.	Type No.	Absolute Maximum Ratings					Electrical Characteristics					Weight (mg)	Based on AEC-Q101	Automotive	Series
			VRRM [V]	IF (AV) [A]	Conditions Tc [°C]	IFSM [A]	Tj [°C]	Vf (max) [V]	Conditions IF [A]	Ir (max) VR=VRM [μA]	trr (max) [ns]					
DO-219AA similar M1F	B2	M1FK60	600	1.0	116 *1	15	150	1.50	1.0	10	75	25	25	—	○	K series
		M1FL20U	200	1.1	25 *2	30	150	0.98	1.1	10	35	25	25	○	○	—
		M1FL40U	400	1.5	139	30	175	1.20	1.0	10	25	25	25	■	○	—
DO-214AC 1F	B3-1	D1FK60	600	0.8	29 *2	20	150	1.30	0.8	10	75	58	58	○	○	K series
		D1FK70	700	0.8	32 *2	25	150	1.30	0.8	10	400	58	58	○	○	—
		D1FK100	1000	1.0	97 *1	20	150	2.10	1.0	10	75	59	59	○	○	K series
		D1FK120	1200	1.0	75 *1	20	150	3.00	1.0	10	120	58	58	—	■	K series
		D1FL20U	200	1.1	25 *2	20	150	0.98	1.1	10	35	58	58	○	○	—
SC-110B CE	B5-1	D3CE20LUS	200	3.0	105 *1	60	-55 to 150	0.98	3.0	10	25	12	12	○	○	—
		D3CE60K	600	3.0	78 *1	50	150	1.45	3.0	10	80	28	28	○	○	K series
DO-214AA similar M2F	B6	M2FL20U	200	1.5	31 *2	50	150	0.92	1.5	10	35	75	75	—	○	—
		M3FL20U	200	3.0	75 *1	75	150	0.95	3.0	10	35	75	75	○	○	—
DO-214AA similar M2F	B9-1	D2FL40	400	1.3	25 *2	40	150	1.30	1.3	10	50	175	175	—	—	—
		D2FL20U	200	1.5	25 *2	50	150	0.98	1.5	10	35	175	175	○	○	—
		D2FK60	600	1.5	101 *1	40	150	1.30	1.5	10	75	175	175	—	○	K series
DO-214AA similar M2F	B9-1	D3FK60	600	2.1	93 *1	120	150	1.20	2.1	10	75	175	175	—	○	K series
		DE3L20UA	200	3.0	137	60	150	0.98	3.0	10	35	310	310	—	■	—
		DE3L40A	400	3.0	132	60	150	1.30	3.0	10	50	310	310	—	■	—
SC-63 E-pack	G1-5	DE5L60U	600	5.0	91	60	150	3.00	5.0	25	25	310	310	—	—	—
		DE5L60A	600	5.0	119	60	150	2.00	5.0	10	50	310	310	—	■	—
TO-277A FY	G4	D5FY60K	600	5.0	130 *1	200	-55 to 150	1.25	5.0	10	95	108	108	—	■	K series
SC-83 similar STO-220	H1-2	DF8L60US	600	8.0	66	60	150	3.60	8.0	50	25	1420	1420	—	—	US series
		DF10L60	600	10.0	105	100	150	1.90	10.0	10	50	1420	1420	—	—	—
		DF20L60	600	20.0	84	170	150	1.90	20.0	25	70	1420	1420	—	—	—
		DF20L60U	600	20.0	93	160	150	3.00	20.0	25	35	1420	1420	—	—	—
SC-83 similar FD	H2-1	D8FD60LUS	600	8.0	120	60	175	3.60	8.0	50	25	1470	1470	—	○	US series
		D20FD60LU	600	20.0	93	160	150	3.00	20.0	25	35	1420	1420	—	○	—
		D30FD60K	600	30.0	102	300	150	1.70	30.0	10	95	1470	1470	—	■	K series







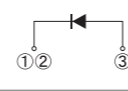

■ : New product *1 : Tl *2 : Ta ■ : Please contact us.

Axial																
JEDEC Code JEITA Code House Name	Fig.	Type No.	Absolute Maximum Ratings					Electrical Characteristics					Weight (mg)	Based on AEC-Q101	Automotive	Series
			VRRM [V]	IF (AV) [A]	Conditions Ta [°C]	IFSM [A]	Tj [°C]	Vf (max) [V]	Conditions IF [A]	Ir (max) VR=VRM [μA]	trr (max) [ns]					
AX057	A1	D1NF60	600	0.8	25	50	150	1.30	0.8	10	400	185	185	—	—	—
		D1NK60	600	0.8	26	35	150	1.30	0.8	10	75	185	185	—	—	K series
		D1NL20U	200	1.0	25	25	150	0.98	1.0	10	35	185	185	—	—	—
		D1NL40U	400	1.0	137 *1	50	150	1.25	1.0	10	25	185	185	—	—	—
		D1NK100	1000	1.0	127 *1	30	150	2.10	1.0	10	75	185	185	—	—	K series
AX078	A4-1	D2L20U	200	1.5	125 *1	40	150	0.98	1.5	10	35	400	400	—	—	—
		D2L40U	400	2.0	108 *1	80	150	1.25	2.0	10	35	400	400	—	—	—
AX10	A5-1	S2L20U	200	1.5	25	50	150	0.98	1.5	10	35	657	657	—	—	—
		S2L60	600	1.5	125 *1	50	150	1.50	1.5	10	50	657	657	—	—	—
		S2L40U	400	2.0	120 *1	100	150	1.25	2.0	10	35	657	657	—	—	—
AX14	A7	S2K100	1000	2.0	91 *1	65	150	2.10	2.0	10	75	657	657	—	—	K series
		S3L60	600	2.2	132 *1	60	150	1.50	2.2	10	50	1060	1060	—	—	—
		S3L20U	200	3.0	128 *1	60	150	0.98	2.1	10	35	1060	1060	—	—	—
AX14	A7	S3L40U	400	3.0	126 *1	150	150	1.25	3.0	10	35	1060	1060	—	—	—
		S3K60	600	3.0	123 *1	120	150	1.30	3.0	10	100	1060	1060	—	—	K series

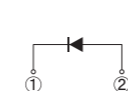
*1 : Tl

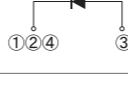

FAST RECOVERY DIODES

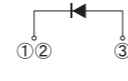
Single



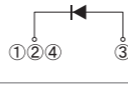

Two Terminal Type											
Package	JEDEC Code JEITA Code House Name	Fig.	IF(AV) [A]	VRRM[V]			Remarks				
				200	400	600					
 28.5 × 10.0 × 4.5(mm)	SC-91A FTO-220	J1	3			SF3L60U					
			5			SF5L60U					
			10			SF10L60U					
			20			SF20L60U					
						SF3K60M					
 28.5 × 10.0 × 4.5(mm)	SC-91 FTO-220AG	J3	3			SF3K60M					
			5		SF5L40UM	SF5K60M					
			8			SF8K60USM SF8K60M					
			10			SF10K60M SF10L60MVM SF10L60MSM					
			20			SF20K60M SF20L60MVM SF20L60MSM					
			 28.5 × 10.0 × 4.5(mm)	SC-91 FTO-220G	J4	5		SG5L20USM			
						10		SG10L20USM			
			 41.0 × 16.0 × 5.0(mm)	TO-247AD MTO-3PT	K2	20				S20K60T	
30						S30K60T					
 40.0 × 15.0 × 5.5(mm)	SC-93 ITO-3P	K1	30			D30L60					

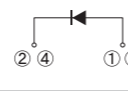
■ : New product

Three Terminal Type

Package	JEDEC Code JEITA Code House Name	Fig.	IF(AV) [A]	VRRM[V]			Remarks
				600	1000	1200	
 41.0 × 16.0 × 5.0(mm)	TO-247AD MTO-3PV	K6	20		S20K100V		
			30	S30K60V	S30K100V		
 41.0 × 16.0 × 5.0(mm)	TO-247AD MTO-3P	K4-3	60			S60L120D	

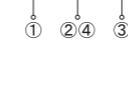
Center Tap, Common Cathode

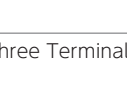
Surface Mount								
Package	JEDEC Code JEITA Code House Name	Fig.	IF(AV) [A]	VRRM[V]				Remarks
				200	300	400	600	
 9.5 × 6.6 × 2.65(mm)	SC-63 E-pack	G1-1	5	DE5LC20U		DE5LC40		
 13.2 × 10.2 × 4.7(mm)	SC-83 similar STO-220	H1-1	10	DF10LC20U	DF10LC30			
			20	DF20LC20US	DF20LC30			
 13.2 × 10.2 × 4.6(mm)	SC-83 similar FD	H2-2	20	■ D20FDC20L D20FDC20LUS				

■ : New product Refer to P35 for Three Terminal Type.

Single

Two Terminal Type															
Package		Type No.	Absolute Maximum Ratings				Electrical Characteristics				Weight (mg)	Based on AEC-Q101	Automotive	Series	
JEDEC Code JEITA Code House Name	Fig.		VRRM [V]	IF (AV) [A]	Conditions Tc [°C]	IFSM [A]	Tj [°C]	Vf (max) [V]	Conditions IF [A]	Ir (max) Vr=VRRM [μA]					ttr (max) [ns]
SC-91A FTO-220	J1	SF3L60U	600	3.0	115	40	150	3.00	3.0	25	20	1900	-	-	-
		SF5L60U	600	5.0	96	60	150	3.00	5.0	25	25	1900	-	-	-
		SF10L60U	600	10.0	85	120	150	3.00	10.0	25	25	1900	-	■	-
		SF20L60U	600	20.0	68	180	150	3.00	20.0	25	35	1900	-	■	-
SC-91 FTO-220AG	J3	SF3K60M	600	3.0	132	90	150	1.45	3.0	10	80	1540	-	-	K series
		SF5L40UM	400	5.0	121	100	150	1.25	5.0	10	30	1540	-	■	-
		SF5K60M	600	5.0	119	120	150	1.50	5.0	10	85	1540	-	■	K series
		SF8K60USM	600	8.0	70	60	150	3.60	8.0	50	25	1580	-	-	US series
		SF8K60M	600	8.0	108	150	150	1.50	8.0	10	90	1540	-	■	K series
		SF10K60M	600	10.0	106	180	150	1.50	10.0	10	95	1540	-	-	K series
		■ SF10L60MVM	600	10.0	119	200	150	1.10	10.0	10	115	1580	-	-	ML series
		■ SF10L60MSM	600	10.0	110	160	150	1.37	10.0	10	60	1580	-	-	ML series
		SF20K60M	600	20.0	96	240	150	1.50	20.0	10	95	1540	-	-	K series
		■ SF20L60MVM	600	20.0	106	250	150	1.10	20.0	10	130	1580	-	-	ML series
■ SF20L60MSM	600	20.0	96	220	150	1.37	20.0	10	70	1580	-	-	ML series		
SC-91 FTO-220G	J4	SG5L20USM	200	5.0	125	90	150	0.96	5.0	10	25	1580	-	-	-
		SG10L20USM	200	10.0	101	200	150	0.96	10.0	10	25	1580	-	-	-
TO-247AD MTO-3PT	K2	S20K60T	600	20.0	121	300	150	1.50	20.0	10	95	5130	-	-	K series
		S30K60T	600	30.0	123	450	150	1.50	30.0	10	100	5130	-	-	K series
SC-93 ITO-3P	K1	D30L60	600	30.0	85	600	150	1.50	30.0	25	150	4350	-	-	-

■ : New product ■ : Please contact us.

Three Terminal Type

Three Terminal Type															
Package		Type No.	Absolute Maximum Ratings				Electrical Characteristics				Weight (mg)	Based on AEC-Q101	Automotive	Series	
JEDEC Code JEITA Code House Name	Fig.		VRRM [V]	IF (AV) [A]	Conditions Tc [°C]	IFSM [A]	Tj [°C]	Vf (max) [V]	Conditions IF [A]	Ir (max) Vr=VRRM [μA]					ttr (max) [ns]
TO-247AD MTO-3PV	K6	S20K100V	1000	20.0	127	550	150	2.10	20.0	10	120	6220	-	○	K series
		S30K60V	600	30.0	108	450	150	1.50	30.0	10	100	6220	-	○	K series
		S30K100V	1000	30.0	116	600	150	2.10	30.0	10	120	6220	-	○	K series
TO-247AD MTO-3P	K4-3	S60L120D	1200	60.0	54	450	150	2.70	60.0	100	300	6170	-	-	-

Refer to P31 for the features of the series.







Center Tap, Common Cathode

Surface Mount															
Package		Type No.	Absolute Maximum Ratings				Electrical Characteristics				Weight (mg)	Based on AEC-Q101	Automotive	Series	
JEDEC Code JEITA Code House Name	Fig.		VRRM [V]	IF (AV) [A]	Conditions Tc [°C]	IFSM [A]	Tj [°C]	Vf (max) [V]	Conditions IF [A]	Ir (max) Vr=VRRM [μA]					ttr (max) [ns]
SC-63 E-pack	G1-1	DE5LC20U	200	5.0	81	50	150	0.98	2.5	10	35	310	-	■	-
		DE5LC40	400	5.0	61	50	150	1.30	2.5	10	50	310	-	■	-
SC-83 similar STO-220	H1-1	DF10LC20U	200	10.0	127	80	150	0.98	5.0	10	35	1420	-	-	-
		DF10LC30	300	10.0	124	80	150	1.30	5.0	25	30	1420	-	-	-
		DF20LC20US	200	20.0	125	180	150	0.96	10.0	10	25	1420	-	-	-
SC-83 similar FD	H2-2	■ D20FDC20L	200	20.0	113	100	175	1.20	10.0	10	30	1410	○	○	-
		D20FDC20LUS	200	20.0	125	180	150	0.96	10.0	10	25	1430	-	○	-

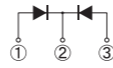
■ : New product ■ : Please contact us.

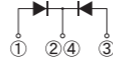
FAST RECOVERY DIODES

Center Tap, Common Cathode

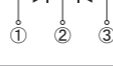
Three Terminal Type								
Package	JEDEC Code JEITA Code House Name	Fig.	I _{F(AV)} [A]	V _{RRM} [V]				Remarks
				200	300	400	600	
 28.5 × 10.0 × 4.5(mm)	SC-91 FTO-220AG	J8-1	5			SF5LC40UM		
			10			SF10LC40UM	SF10KC60M	
			20		SF20LC30M	SF20KC60M		
 28.5 × 10.0 × 4.5(mm)	SC-91 FTO-220G	J9	5	SG5LC20USM				
			10	SG10LC20USM				
			20	SG20LC20USM				
 41.0 × 16.0 × 5.0(mm)	TO-247AD MTO-3PT	K5-2	20	S20LC20UST	S20LC30T	S20LC40UT	S20LC60UST	
 41.0 × 16.0 × 5.0(mm)	TO-247AD MTO-3PV	K7-1	20			S20LC40UV	S20LC60USV	
 40.0 × 15.0 × 5.5(mm)	SC-93 ITO-3P	K3-1	20	D20LC20U		D20LC40		

Refer to P33 for Surface Mount.

Diode Module

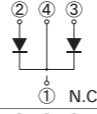
Package	JEDEC Code JEITA Code House Name	Fig.	I _{F(AV)} [A]	V _{RRM} [V]				Remarks
				200	300	400	600	
 43.0 × 27.0 × 21.0(mm)	Module	F2	120			D120LC40B		
			200			D200LC40B		
		F3-2	120			D120LC40		
			240			D240LC40		

Center Tap, Common Cathode

Three Terminal Type															
Package		Type No.	Absolute Maximum Ratings					Electrical Characteristics				Weight (mg)	Based on AEC-Q101	Automotive	Series
JEDEC Code JEITA Code House Name	Fig.		V _{RRM} [V]	I _{F(AV)} [A]	Conditions T _c [°C]	I _{FSM} [A]	T _j [°C]	V _F (max) [V]	Conditions I _F [A]	I _R (max) V _R =V _{RRM} [μA]	t _{rr} (max) [ns]				
SC-91 FTO-220AG	J8-1	SF5LC40UM	400	5.0	132	80	150	1.25	2.5	10	30	1540	-	-	-
		SF10LC40UM	400	10.0	120	100	150	1.25	5.0	10	30	1540	-	-	-
		SF10KC60M	600	10.0	109	120	150	1.50	5.0	10	85	1540	-	■	K series
		SF20LC30M	300	20.0	107	250	150	1.30	10.0	25	30	1580	-	-	-
SC-91 FTO-220G	J9	SG5LC20USM	200	5.0	133	70	150	0.96	2.5	10	25	1580	-	-	-
		SG10LC20USM	200	10.0	122	90	150	0.96	5.0	10	25	1580	-	-	-
		SG20LC20USM	200	20.0	95	150	150	0.96	10.0	10	25	1580	-	-	-
TO-247AD MTO-3PT	K5-2	S20LC20UST	200	20.0	126	120	150	0.96	10.0	10	25	5130	-	-	-
		S20LC30T	300	20.0	124	220	150	1.30	10.0	25	30	5130	-	-	-
		S20LC40UT	400	20.0	123	130	150	1.25	10.0	10	30	5130	-	-	-
TO-247AD MTO-3PV	K7-1	S20LC60UST	600	20.0	63	60	150	3.60	10.0	50	25	5130	-	-	-
		S20LC40UV	400	20.0	123	200	150	1.25	10.0	10	30	6210	-	○	-
SC-93 ITO-3P	K3-1	S20LC60USV	600	20.0	65	60	150	3.60	10.0	50	25	6150	-	○	-
		D20LC20U	200	20.0	112	150	150	0.98	10.0	10	35	4350	-	-	-
		D20LC40	400	20.0	102	120	150	1.30	10.0	10	50	4350	-	-	-

■ : Please contact us. Refer to P31 for the features of the series.

Diode Module





Diode Module															
Package		Type No.	Absolute Maximum Ratings					Electrical Characteristics				Weight (mg)	Based on AEC-Q101	Automotive	Series
JEDEC Code JEITA Code House Name	Fig.		V _{RRM} [V]	I _{F(AV)} [A]	Conditions T _c [°C]	I _{FSM} [A]	T _j [°C]	V _F (max) [V]	Conditions I _F [A]	I _R (max) V _R =V _{RRM} [μA]	t _{rr} (max) [ns]				
Module	F2	D120LC40B	400	120.0	60	650	150	1.3	60	25	100	42000	-	-	-
		D200LC40B	400	200.0	52	1400	150	1.3	100	50	150	42100	-	-	-
	F3-2	D120LC40	400	120.0	95	650	150	1.3	60	25	100	61000	-	-	-
		D240LC40	400	240.0	77	1400	150	1.3	120	50	150	64000	-	-	-

THYRISTORS

The Thyristor, in its normal state, will block an applied voltage in either direction, but when an appropriate current pulse is applied to the gate, current will flow through the anode to the cathode thus turning on power to the load circuit. The Thyristor has a planar passivation, and is available in both the general reverse-blocking type and the type without reverse voltage. The Thyristor without reverse voltage is suitable for a circuit limiting inrush current.

SIDAC series are semiconductor devices energized by the addition of a specific voltage. They are commonly used for switching devices or pulse generating devices.

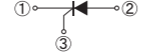

Thyristors

Package		
JEDEC Code JEITA Code House Name	TO-252AA - FB	SC-91 FTO-220AG
Fig.	G2-2	J8-5
Internal Circuit		
I_T (AV) [A]	3	5
V_{DRM} [V]	400	KC3FB40H
	600	KC5FB40H KC5FB60H KC5FB60HR KC5FB60HRT
	800	 KC8SF80

 : New product

SIDAC K1V Series (Bi-directional)

- Features
 1. Symmetrical characteristics.
 2. Operating directly from the AC mains, and can be used in all kinds of pulse generating circuits.
 3. The glass passivation ensures high reliability.
- Applications
 1. Pulse generation : gas igniters, HID (high intensity discharge) lamp drive circuit, etc.
 2. AC switching : drive circuit for switching power supplies, voltage detecting circuits, etc.
 3. Over voltage protection : AC line surge protection, capacitor rupture prevention, etc.

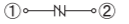
Package			
JEDEC Code JEITA Code House Name	DO-214AC - 1F	- AX06	- AX10
Fig.	B4-3	A2-1	A5-3
Internal Circuit			
V_{DRM} [V]	5	K1VZL09	
	15	K1VZL20	
	90	K1V(A)10 K1V(A)11 K1V(A)12	K1V10 K1V11 K1V12
	115	K1V(A)16	K1V14
	180		K1V22 K1V24 K1V26
	270		K1V36(W) K1V38(W)

Thyristors

Package		Type No.	Absolute Maximum Ratings							Electrical Characteristics				Weight (mg)	Based on AEC-Q101	Automotive
JEDEC Code JEITA Code House Name	Fig.		V_{DRM} [V]	V_{RRM} [V]	I_T (AV) [A]	Conditions T_C [°C]	I_{TSM} [A]	di/dt [A/μs]	T_J [°C]	I_{DRM} (max) [μA]	Conditions V_D [V]	I_H (max) [mA]	$R_{th(j-c)}$ (max) [°C/W]			
TO-252AA - FB	G2-2	KC3FB40H	400	400	3	111	40	50	-40 to 125	50	400	5	3.00	320	-	-
		KC5FB40H	400	400	5	101	65	50	-40 to 125	100	400	typ.1	3.00	320	-	-
		KC5FB60H	600	600	5	98	90	50	-40 to 125	10	600	5	3.00	320	-	-
		KC5FB60HR	600	-	5	98	90	50	-40 to 125	10	600	5	3.00	320	-	-
SC-91 FTO-220AG	J8-5	 KC8SF80	800	800	8	130	120	50	-40 to 150	10	600	100	1.49	1580	-	-

 : New product

SIDAC K1V Series (Bi-directional)

Surface Mount		Type No.	Absolute Maximum Ratings						Electrical Characteristics						Weight (mg)	Automotive
JEDEC Code JEITA Code House Name	Fig.		V_{DRM} [V]	I_T [A]	Conditions T_L [°C]	T_{stg} [°C]	T_J [°C]	V_{BO} [V]	I_{DRM} (max) [μA]	Conditions V_D [V]	I_{BO} (max) [mA]	I_H (typ) [mA]	V_T (max) [V]	Conditions I_T [A]		
DO-214AC - 1F	B4-3	K1VZL09	5	0.5	110	-40 to 125	125	8 to 12	5	5	20	20	1.2	0.5	58	-
		K1VZL20	15	0.5	110	-40 to 125	125	18 to 22	5	15	20	20	1.2	0.5	58	-

Axial





Package		Type No.	Absolute Maximum Ratings							Electrical Characteristics						Weight (mg)	Automotive
JEDEC Code JEITA Code House Name	Fig.		V_{DRM} [V]	I_T [A]	Conditions T_L [°C]	I_{TSM} [A]	I_{TRM} [A]	Conditions f [Hz]	dit/dt [A/μs]	T_J [°C]	V_{BO} [V]	I_H (typ) [mA]	V_T (max) [V]	Conditions I_T [A]	R_s (min) [kΩ]		
- AX06	A2-1	K1V(A)10	90	1	109	16	60	60	50	125	95 to 113	50	1.6	1	0.1	220	-
		K1V(A)11	90	1	109	16	60	60	50	125	104 to 118	50	1.6	1	0.1	220	-
		K1V(A)12	90	1	109	16	60	60	50	125	110 to 125	50	1.6	1	0.1	220	-
		K1V(A)16	115	1	98	16	60	60	50	125	145 to 170	50	1.6	1	0.1	220	-
- AX10	A5-3	K1V10	90	1	112	20	80	60	80	125	95 to 113	50	1.5	1	0.1	640	-
		K1V11	90	1	112	20	80	60	80	125	104 to 118	50	1.5	1	0.1	640	-
		K1V12	90	1	112	20	80	60	80	125	110 to 125	50	1.5	1	0.1	640	-
		K1V14	115	1	109	20	80	60	80	125	125 to 150	30	1.5	1	0.1	640	-
		K1V22	180	1	108	20	50	60	80	125	200 to 230	20	1.5	1	0.1	640	-
		K1V24	180	1	108	20	50	60	80	125	220 to 250	20	1.5	1	0.1	640	-
	A6	K1V26	180	1	108	20	50	60	80	125	240 to 270	20	1.5	1	0.1	640	-
		K1V22(W)	180	1	91	16	50	60	80	125	200 to 230	50	3	1	0.1	640	-
		K1V24(W)	180	1	91	16	50	60	80	125	220 to 250	50	3	1	0.1	640	-
		K1V26(W)	180	1	91	16	50	60	80	125	240 to 265	50	3	1	0.1	640	-
		K1V36(W)	270	1	92	13	40	60	50	125	340 to 380	50	3	1	0.1	640	-
		K1V38(W)	270	1	92	13	40	60	80	125	360 to 400	50	3	1	0.1	640	-

THYRISTORS

SIDAC G1V Series (Uni-directional)

- Features
1. Uni-directional characteristics.
 2. Smaller package than bi-directional SIDAC.
 3. Switching operation from DC power for pulse generation.
 4. The glass passivation ensures high reliability.

- Applications
1. Pulse generation : gas igniters, negative ion generators, HID (high intensity discharge) lamp drive circuit, etc.
 2. Over voltage protection : DC line surge protection.

Package				
	5.0 × 2.5 × 2.0(mm)	5.0 × φ 2.6(mm)	5.0 × φ 4.0(mm)	
JEDEC Code	DO-214AC	—	—	
JEITA Code	—	—	—	
House Name	1F	AX06	AX078	
Fig.	B3-3	A2-3	A4-3	
Internal Circuit				
V _{DRM(A)} [V]	70	G1VL8C	G1V(A)8C	
	90	G1VL10C	G1V(A)10C	
	100		G1V(A)12C	
	110		G1V(A)13C	
	115		G1V(A)15C	
	120	G1VL15C	G1V(A)14C	
	170	G1VL20C	G1V(A)20C	G1V(B)20C
	190	G1VL22C		G1V(B)22C
210	G1VL24C		G1V(B)24C	

SIDAC G1V Series (Uni-directional)

Package		Type No.	Absolute Maximum Ratings						Electrical Characteristics				Weight (mg)	Automotive	
JEDEC Code	Fig.		V _{DRM(A)} [V]	I _T [A]	Conditions T _L [°C]	I _{TRM} [A]	Conditions f [Hz]	dit/dt [A/μs]	T _j [°C]	V _{BO} [V]	I _H (max) [mA]	V _T (max) [V]			Conditions I _T [A]
DO-214AC 1F	B3-3	G1VL8C	70	1	98	80	60	150	125	75 to 90	100	1.5	1	58	—
		G1VL10C	90	1	98	150	60	150	125	95 to 110	100	1.5	1	58	—
		G1VL15C	120	1	98	120	60	150	125	142 to 157	60	1.5	1	58	—
		G1VL20C	170	1	98	120	60	150	125	190 to 210	60	1.5	1	58	—
		G1VL22C	190	1	98	280	5	150	125	210 to 230	60	1.5	1	58	—
		G1VL24C	190	1	98	280	5	150	150	230 to 250	60	1.5	1	58	—

Package		Type No.	Absolute Maximum Ratings						Electrical Characteristics				Weight (mg)	Automotive	
JEDEC Code	Fig.		V _{DRM(A)} [V]	I _T [A]	Conditions T _L [°C]	I _{TRM} [A]	Conditions f [Hz]	dit/dt [A/μs]	T _j [°C]	V _{BO} [V]	I _H (max) [mA]	V _T (max) [V]			Conditions I _T [A]
— AX06	A2-3	G1V(A)8C	70	1	98	80	60	80	125	75 to 90	100	1.5	1	220	—
		G1V(A)10C	90	1	98	80	60	80	125	95 to 110	60	1.5	1	220	—
		G1V(A)12C	100	1	98	80	60	80	125	110 to 130	60	1.5	1	220	—
		G1V(A)13C	110	1	98	80	60	80	125	120 to 138	60	1.5	1	220	—
		G1V(A)14C	120	1	98	80	60	80	125	130 to 150	60	1.5	1	220	—
		G1V(A)15C	115	1	98	80	60	80	125	142 to 157	60	1.5	1	220	—
		G1V(A)20C	170	1	98	80	60	80	125	190 to 210	60	1.5	1	220	—
— AX078	A4-3	G1V(B)20C	170	1	102	120	60	220	150	190 to 210	60	1.5	1	390	—
		G1V(B)22C	190	1	98	160	60	220	125	210 to 230	60	1.5	1	390	—
		G1V(B)24C	210	1	102	120	60	220	150	230 to 250	60	1.5	1	390	—









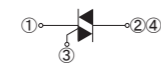
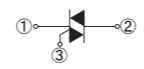

TRIACs

TRIACs are bidirectional Thyristors.

Our TRIACs are easy to use for motor and heater controls due to balanced gate sensitivity and $(di/dt)_c$.









Our lineup ranges from $V_{DRM}=600$ to 800V, $I_{T(RMS)}=3$ to 20A.

TRIACs (Triode for Alternating Current)

Package	 10.0 × 6.6 × 2.3(mm)	 28.5 × 10.0 × 4.5(mm)
JEDEC Code JEITA Code House Name	TO-252AA - FB	- SC-91 FTO-220AG
Fig.	G2-3	J8-4
Internal Circuit		
$V_{DRM}[V]$	600	
$I_{T(RMS)} [A]$	3	 KD3FB60
	5	 KD3SF60E  KD3SF60
	8	 KD5SF60
	12	 KD8SF60
	16	 KD12SF60
	20	 KD16SF60  KD20SF60

 : New product

TRIACs (Triode for Alternating Current)

Package		Type No.	Absolute Maximum Ratings			Electrical Characteristics					Weight (mg)	Based on AEC-Q101	Automotive
JEDEC Code JEITA Code House Name	Fig.		I_T (RMS) [A]	V_{DRM} [V]	T_J [°C]	V_{TM} (max) [V]	Conditions I_{TM} [A]	I_{GT} (max) (1,2,3)* [mA]	$(di/dt)_c$ ($T_j=150^\circ C, V_D=2/3V_{DRM}$) [V/ μs]	Conditions $(di/dt)_c$ [A/ms]			
TO-252AA - FB	G2-3	 KD3FB60	3	600	-40 to 150	1.7	4.5	15.0	1.0	-1.5	320	-	-
- SC-91 FTO-220AG	J8-4	 KD3SF60E	3	600	-40 to 150	1.5	4.5	10.0	-	-	1580	-	-
		 KD3SF60	3	600	-40 to 150	1.5	4.5	20.0	1.0	-1.5	1580	-	-
		 KD5SF60	5	600	-40 to 150	1.8	7	20.0	1.0	-2.5	1580	-	-
		 KD8SF60	8	600	-40 to 150	1.6	12	30.0	1.0	-4.0	1580	-	-
		 KD12SF60	12	600	-40 to 150	1.6	20	30.0	1.0	-6.0	1580	-	-
		 KD16SF60	16	600	-40 to 150	1.5	25	30.0	1.0	-8.0	1580	-	-
 KD20SF60	20	600	-40 to 150	1.4	30	30.0	1.0	-10.0	1580	-	-		

 : New product * : Operation mode IV is not guaranteed.

Operation Mode	Terminal Characteristics		
	① T1	②④ T2	③ G
I	-	+	+
II	-	+	-
III	+	-	-
IV	+	-	+



SURGE ABSORBERS

Surge Absorbers are semiconductor devices of the Thyristor type that turns on when triggered by their rated voltage. They are commonly used for lightning surge protection in communications equipment.

Thyristor Surge Suppressors

- Features
1. Bi-directional or uni-directional characteristics.
 2. High speed response.
 3. Large surge current capacity.
 4. Repetitive use against surges is possible.

- Applications
1. Lightning surge adsorption for communications circuits.
 2. Lightning surge adsorption for transmitters and switchboards.
 3. Surge protection for ISDN terminals.

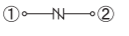
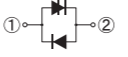
Series	KL Series	KU Series	KP Series	
Package	 5.0 × 2.5 × 2.0(mm)	 5.1 × 3.75 × 2.0(mm)	 7.6 × 4.0 × 2.8(mm)	
JEDEC Code JEITA Code House Name	DO-214AC - 1F	DO-214AA similar - M2F	- - 2F	
Fig.	B4-3	B7	B8	
Internal Circuit				
Off-state Voltage V _D [V]	5	KL3Z07		
	15	KL3Z18		
	58	KL3L07		
	63		KU10L08	
	90		KU10NU11	
	92			KP20NU11 KP40NU11
	100		KU4F8 KU4F12	
	115		■ KU10NU13	
	120	KL3N14	KU10N14 KU15N14	
	175	KL3R20		
	180			KP40RU22
	190		KU10R23NS	
	220		KU10R27NS	
250		KU10R29NS		
275		KU5S31NS KU10S31NS KU10S35NS		

■ : New product

Thyristor Surge Suppressors

Package		Type No.	Absolute Maximum Ratings				Electrical Characteristics			Weight (mg)	UL	Automotive
JEDEC Code JEITA Code House Name	Fig.		I _{TSM} [A]	Conditions [μs]	V _{DRM} [V]	T _j [°C]	V _{BO} (min) [V]	I _H (min) [mA]	C _t (max) [pF]			
DO-214AC - 1F	B4-3	KL3Z07	30	10/1000	5	125	5.5 *1	50	-	58	-	-
		KL3Z18	30	10/1000	15	125	15.5 *1	50	-	58	-	-
		KL3L07	30	10/1000	58	125	65	100	90	58	-	-
		KL3N14	30	10/1000	120	125	130	100	50	58	-	-
		KL3R20	30	10/1000	175	125	180	100	30	58	-	-
DO-214AA similar - M2F	B7	KU10L08	100	10/1000	63	125	70	100	180	75	■	-
	B8	KU10NU11	100	10/1000	60	125	100	150	-	77	-	-
	B7	KU4F8	40	10/1000	70	125	75	100	100	75	-	-
		KU4F12	40	10/1000	100	125	110	100	100	75	-	-
	B8	■ KU10NU13	100	10/1000	60	125	120	100	-	77	-	-
		KU10N14	100	10/1000	120	125	125	100	140	75	■	-
		KU15N14	150	10/1000	120	125	125	100	110	75	■	-
		KU10R23NS	100	10/1000	190	125	-	100	90	75	-	-
		KU10R27NS	100	10/1000	220	125	-	100	70	72	■	-
		KU10R29NS	100	10/1000	250	125	-	100	70	72	■	-
		KU5S31NS	50	10/1000	275	125	-	150	70	75	-	-
		KU10S31NS	100	10/1000	275	125	-	100	90	72	■	-
KU10S35NS	100	10/1000	275	125	-	100	90	75	-	-		
- - 2F	B9-4	KP20NU11	325	10/700	60	125	100	150	295 *2	180	-	-
		KP40NU11	500	10/700	60	125	100	150	485 *2	180	-	-
		KP40RU22	500	10/700	60	125	195	100	285 *2	180	-	-

■ : New product *1 : V_{BR} *2 : typ. ■ : UL497B recognized (UL File No.E183905)



Varistor

Package		Type No.	Absolute Maximum Ratings			Electrical Characteristics		Weight (mg)	Automotive
JEDEC Code JEITA Code House Name	Fig.		I _{F(RMS)} [mA]	I _{FSM} [A]	T _j [°C]	V _{F1} [V]	Conditions I _F [mA]		
DO-214AC - 1F	B4-1	VR-61F1	370	7.5	150	2.3 ± 0.25	1	58	-

Varistor

- Features
1. Bi-directional surge absorption is possible.
 2. Low junction capacitance.

- Applications
1. Telephone set surge absorption.
 2. Digital communications circuit surge absorption.
 3. ISDN terminal surge absorption.

Package	 5.0 × 2.5 × 2.0(mm)
JEDEC Code JEITA Code House Name	DO-214AC - 1F
Fig.	B4-1
Internal Circuit	
V _{F2} [V]	2.75 ± 0.25
	VR-61F1

TVS DIODES

TVS diodes are low voltage PN junction type devices.

These devices utilize technologically stable glass passivation (an in-house design) with a structural advantage that brings high resistance against heat and humidity.

They are available with a voltage range between 12 to 320V and power dissipation from 1 to 5W.

TVS (Transient Voltage Suppressor)

- Features
- 1.High speed response.
 - 2.Absorption energy tolerance capacity.
 - 3.Narrow clamping voltage width.

- Applications
- 1.IC protection for telephones.
 - 2.IC protection against abnormal voltage.
 - 3.Protection for load dump noise.

Power Dissipation	1W		2W	3W		5W (Load Dump Surge Protecting)		
Package								
JEDEC Code JEITA Code House Name	DO-219AB similar SC-109 G1F	DO-214AC 1F	DO-214AC 1F (Bi-directional)	SC-110B CE	2F	MCP	SC-83 similar STO-220	TO-263AB FZ
Fig.	B1-2	B3-2	B4-2	B5-2	B9-5	B10	E1	H1-6 H6
Internal Circuit								
V _{BR} (typ) [V]	12.5	ST02-12G1	ST04-12F1					
	14	ST02-14G1	ST04-14F1				ST80-14MF	
	16	ST02-16G1	ST04-16F1					
	18	ST02-18G1	ST04-18F1	DL04-18F1	★ ST06-18CE			
	20	ST02-20G1	ST04-20F1					
	24	ST02-24G1	ST04-24F1					
	27	ST02-27G1	ST04-27F1		★ ST06-27CE	ST20-27F2	ST70-27MF	ST70-27F
	30	ST02-30G1	ST04-30F1		★ ST06-30CE	ST20-30F2	ST70-30MF	ST70-27FZ
	33	ST02-33G1	ST04-33F1	DL04-33F1	★ ST06-33CE	ST20-33F2		
	36	ST02-36G1	ST04-36F1	DL04-36F1	★ ST06-36CE	ST20-36F2		
	39	ST02-39G1	ST04-39F1		★ ST06-39CE			
	40							ST60-40MF
	43	ST02-43G1	ST03-43F1					
	47	ST02-47G1	ST03-47F1			ST20-47F2		
	48							ST60-48MF
	58	ST02-58G1	ST03-58F1					
	68		ST03-68F1					
	75		ST02-75F1					
	82		ST02-82F1					
	100		ST02-100F1					
120		ST02-120F1						
145		ST02-140F1						
170		ST02-170F1						
200		ST02-200F1						
240		ST03-240F1						
280		ST02-280F1						
320		ST02-320F1						

■ : New product ★ : Under development

TVS (Transient Voltage Suppressor)

Package JEDEC Code JEITA Code House Name	Fig.	Type No.	Absolute Maximum Ratings			Electrical Characteristics					Weight (mg)	Based on AEC-Q101	Automotive		
			PrSM [W]	Tj [°C]	Vr (DC) [V]	VBR (min) [V]	VBR (max) [V]	Conditions IR [mA]	Ir (max) [μA]	Conditions VR [V]					
DO-219AB similar SC-109 G1F	B1-2	ST02-12G1	200	-55 to 175	9.0	11.5	13.5	5	5	9.0	12	○	○		
		ST02-14G1	200	-55 to 175	12.8	13.5	15.0	5	5	12.8	12	○	○		
		ST02-16G1	200	-55 to 175	13.6	14.4	17.6	5	5	13.6	12	○	○		
		ST02-18G1	200	-55 to 175	13.0	16.8	19.1	5	5	13.0	12	○	○		
		ST02-20G1	200	-55 to 175	16.0	18.8	22.0	5	5	16.0	12	○	○		
		ST02-24G1	200	-55 to 175	20.0	22.0	25.6	5	5	20.0	12	○	○		
		ST02-27G1	200	-55 to 175	23.0	25.1	28.9	2	5	23.0	12	○	○		
		ST02-30G1	200	-55 to 175	24.0	28.0	32.0	2	5	24.0	12	○	○		
		ST02-33G1	200	-55 to 175	25.0	31.0	35.0	2	5	25.0	12	○	○		
		ST02-36G1	200	-55 to 175	27.0	34.0	38.0	2	5	27.0	12	○	○		
		ST02-39G1	200	-55 to 175	30.0	37.0	41.0	2	5	30.0	12	○	○		
		ST02-43G1	200	-55 to 175	33.0	40.0	45.0	2	5	33.0	12	○	○		
		ST02-47G1	195	-55 to 175	37.0	42.0	52.0	2	5	37.0	12	■	○		
		ST02-58G1	175	-55 to 175	45.0	52.0	64.0	2	5	45.0	12	○	○		
		DO-214AC 1F	B3-2	ST04-12F1	400	-55 to 175	9.0	11.5	13.5	1	5	9.0	58	○	○
				ST04-14F1	400	-55 to 175	12.8	13.5	15.0	1	5	12.8	58	○	○
				ST04-16F1	400	-55 to 175	13.6	14.4	17.6	1	5	13.6	58	○	○
				ST04-18F1	400	-55 to 175	15.3	16.8	19.1	1	5	15.3	58	○	○
ST04-20F1	400			-55 to 175	16.0	18.8	21.2	1	5	16.0	58	○	○		
ST04-24F1	400			-55 to 175	20.0	22.8	25.6	1	5	20.0	58	○	○		
ST04-27F1	400			-55 to 175	23.0	24.3	29.7	1	5	23.0	58	○	○		
ST04-30F1	400			-55 to 175	24.0	28.0	32.0	1	5	24.0	58	○	○		
ST04-33F1	400			-55 to 175	25.0	31.0	35.0	1	5	25.0	58	○	○		
ST04-36F1	400			-55 to 175	27.0	34.0	38.0	1	5	27.0	58	○	○		
ST04-39F1	400			-55 to 175	30.0	37.0	41.0	1	5	30.0	58	○	○		
ST03-43F1	300			-55 to 150	33.0	40.0	45.0	1	5	33.0	58	○	○		
ST03-47F1	300			-55 to 150	37.0	42.0	52.0	1	5	37.0	58	○	○		
ST03-58F1	300			-55 to 150	45.0	52.0	64.0	1	5	45.0	58	○	○		
ST03-68F1	300			-55 to 150	58.0	64.4	71.2	1	5	58.0	58	○	○		
ST02-75F1	200			-55 to 150	61.0	70.0	79.0	1	5	61.0	58	○	○		
ST02-82F1	200			-55 to 150	67.0	74.0	90.0	1	5	67.0	58	○	○		
ST02-100F1	200			-55 to 150	80.0	90.0	110.0	1	5	80.0	58	○	○		
ST02-120F1	200			-55 to 150	100.0	110.0	130.0	1	5	33.0	58	■	○		
ST02-140F1	200			-55 to 150	120.0	130.0	160.0	1	5	120.0	58	■	○		
ST02-170F1	200	-55 to 150	145.0	155.0	185.0	1	5	145.0	58	■	○				
ST02-200F1	200	-55 to 150	170.0	185.0	215.0	1	5	170.0	58	■	○				
ST03-240F1	310	-55 to 150	200.0	220.0	250.0	1	5	200.0	58	■	○				
ST02-280F1	200	-55 to 175	230.0	250.0	300.0	1	5	230.0	59	○	○				
ST02-320F1	150	-55 to 175	260.0	300.0	350.0	1	5	260.0	59	○	○				
SC-110B CE	B5-2	★ ST06-18CE	600	-55 to 175	13.0	16.8	19.1	1	5	13.0	-	■	■		
		★ ST06-27CE	600	-55 to 175	23.0	25.0	29.0	1	5	23.0	-	■	■		
		★ ST06-30CE	600	-55 to 175	24.0	28.0	32.0	1	5	24.0	-	■	■		
		★ ST06-33CE	600	-55 to 175	25.0	31.0	35.0	1	5	25.0	-	■	■		
		★ ST06-36CE	600	-55 to 175	27.0	34.0	38.0	1	5	27.0	-	■	■		
		★ ST06-39CE	600	-55 to 175	30.0	37.0	41.0	1	5	30.0	-	■	■		
DO-214AC 1F (Bi-directional)	B4-2	DL04-18F1	400	-55 to 150	13.0	16.8	19.1	5	5	13.0	58	■	○		
		DL04-33F1	400	-55 to 175	25.0	31.0	35.0	1	5	25.0	59	○	○		
		DL04-36F1	400	-55 to 175	27.0	34.0	38.0	1	5	27.0	59	■	○		
2F	B10	ST20-47F2	1700	-55 to 175	37.0	42.0	52.0	1	5	37.0	179	○	○		
		ST20-27F2	2000	-55 to 175	23.0	24.3	29.7	1	5	23.0	179	○	○		
		ST20-30F2	2000	-55 to 175	24.0	28.0	32.0	1	5	24.0	179	-	○		
		ST20-33F2	2000	-55 to 175	25.0	31.0	35.0	1	5	25.0	179	○	○		
MCP	E1	ST80-14MF	8000	-40 to 150	12.0	13.0	15.0	1	10	12.0	1900	-	○		
		ST70-27MF	7000	-40 to 150	23.0	24.3	29.7	1	5	23.0	1900	-	○		
		ST70-30MF	7000	-40 to 150	26.0	27.5	33.0	1	5	26.0	1900	-	○		
		ST60-40MF	6000	-40 to 150	32.0	36.5	44.0	1	5	32.0	1900	-	○		
SC-83 similar STO-220 TO-263AB FZ	H1-6 H6	ST70-27F	7000	-40 to 150	23.0	24.3	29.7	1	5	23.0	1420	-	○		
		ST70-27FZ	7000	-55 to 175	23.0	25.0	29.0	1	5	23.0	1850	○	○		





■ : New product ★ : Under development ■ : Please contact us.

TVS DIODES

Power Clampers

- Features
- 1.High speed response.
 - 2.Absorption energy tolerance capacity.
 - 3.Narrow clampingvoltage width.
 - 4.Reverse blocking type.

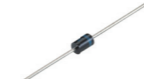
- Application 1.Snubber circuit in the primary side of switch-mode power supplies.

Package	 7.6 × 4.0 × 2.8(mm)	 5.0 × φ 4.0(mm)	 7.0 × φ 4.4(mm)	
JEDEC Code	—	—	—	
JEITA Code	—	—	—	
House Name	2F	AX078	AX10	
Fig.	B9-3	A4-2	A5-2	
Internal Circuit				
V _{BR} (typ) [V]	82		ST02D-82	ST03D-82
	145	ST02D-140F2	ST02D-140	ST03D-140
	170	ST02D-170F2	ST02D-170	ST03D-170
	200		ST02D-200	ST03D-200
	240			ST03DH-240
	280			★ ST02DH-280
320			★ ST02DH-320	

★ : Under development

Power Clampers

Package JEDEC Code JEITA Code House Name	Fig.	Type No.	Absolute Maximum Ratings				Electrical Characteristics						Weight (mg)	Automotive
			PrSM [W]	Tj [°C]	V _{RM} (max) [V]		TVS			Di				
					TVS	Di	V _{BR} (min) [V]	V _{BR} (max) [V]	Conditions I _R [mA]	I _R (max) [μA]	I _R (max) [μA]	Conditions V _R [V]		
— — 2F	B9-3	ST02D-140F2	200	-40 to 150	120	600	130	160	1	5	5	600	175	—
		ST02D-170F2	200	-40 to 150	145	600	155	185	1	5	5	600	175	—
— — AX078	A4-2	ST02D-82	200	-40 to 150	67	600	74	90	1	5	5	600	393	—
		ST02D-140	200	-40 to 150	120	600	130	160	1	5	5	600	393	—
		ST02D-170	200	-40 to 150	145	600	155	185	1	5	5	600	393	—
		ST02D-200	200	-40 to 150	170	600	185	215	1	5	5	600	393	—
— — AX10	A5-2	ST03D-82	300	-40 to 150	67	600	74	90	1	5	5	600	643	—
		ST03D-140	300	-40 to 150	120	600	130	160	1	5	5	600	643	—
		ST03D-170	300	-40 to 150	145	600	155	185	1	5	5	600	643	—
		ST03D-200	300	-40 to 150	170	600	185	215	1	5	5	600	643	—
		ST03DH-240	300	-40 to 150	200	1000	220	250	1	5	10	1000	643	—
		★ ST02DH-280	300	-40 to 150	230	1000	220	250	1	5	10	1000	643	—
★ ST02DH-320	300	-40 to 150	260	1000	220	250	1	5	10	1000	643	—		





★ : Under development

POWER MOSFETS

The EETMOS series offer world-class performance applying a trench-gate structure with an optimized layout hence lowered Qg.

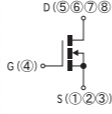
Series	Feature
EETMOS2	Ron, Qg Balance Type
EETMOS3/3Z	Low Ron, Low Qg
EETMOS4	Ultra Low Ron, Low Qg

EETMOS Series (Nch Single)

Surface Mount															
Package	JEDEC Code JEITA Code House Name	Fig.	Id [A]	Vbss [V]							Remarks				
				40	50	55	60	75	100	120	150				
 6.0 × 4.9 × 1.0(mm)	- LA	G6	15							★ P15LA12SL					
			18							★ P18LA12SL					
			19												
			23								★ P23LA10SL				
			25										★ P25LA12SL		
			30								★ P30LA10SL				
 6.05 × 5.30 × 1.05(mm)	MO-235B similar LF	G7	25								☒ P25LF12SL ☒ P25LF12SN				
			32								☒ P32LF10SL ☒ P32LF10SN				
			40								☒ P40LF12SL ☒ P40LF12SN				
			46							☒ P46LF7R5SL ☒ P46LF7R5SN					
			50								☒ P50LF10SL ☒ P50LF10SN				
			64								☒ P64LF6QL ☒ P64LF6QN				
			72								☒ P72LF7R5SL ☒ P72LF7R5SN				
			98								☒ P98LF6QL ☒ P98LF6QN				
			105								☒ P105LF4QL ☒ P105LF4QN				
											☒ P140LF4QL ☒ P140LF4QN				
			140												
			 10.0 × 6.6 × 2.3(mm)	TO-252AA FB	G2-1	8								P8B10SB	
						16								P16B6SB	
						20									P20B12SN P20B12SL
						24								☒ P24B4SB	
25												P25B6EB			
26												P26B10SL P26B10SN			
30												P30B10EL			
32												☒ P32B12SN			
40												☒ P40B10SL ☒ P40B10SN			
54											☒ P54B4SN				
60												P60B6EL P60B6EN P60B6SN			
 9.5 × 6.6 × 2.65(mm)	TO-252AB similar SC-63 FE	G3-2	8								P8FE10SBK				
			12									☒ P12FE7R5SBK			
			14									☒ P14FE6SBK			
			20									P20FE12SLK			
			22									☒ P22FE4SBK			
			26									P26FE10SLK			
			30									P30FE6SLK P30FE7R5SLK			

☒ : New product ★ : Under development Refer to P51 for THD type.

EETMOS Series (Nch Single)





Surface Mount																				
Package		Type No.	Absolute Maximum Ratings					Electrical Characteristics						Weight (mg)	Automotive	Based on AEC-Q101	Series			
JEDEC Code JEITA Code House Name	Fig.		Vbss [V]	Id [A]	Idp [A]	Pt [W]	Tch [°C]	Rdson (typ) [mΩ] Vgs=10V	Rdson (max) [mΩ] Vgs=10V	Ciss (typ) [pF]	Qg (typ) [nC]	Vth (typ) [V]	Rth(jc) (max) [°C/W]							
-	LA	G6	★ P19LA10SL	100	19	57	83	150	28.0	35.0	1730	38	2.0	1.50	95	-	-	EETMOS3		
			★ P23LA10SL	100	23	69	99	150	23.0	29.0	2080	46	2.0	1.26	95	-	-	EETMOS3		
			★ P30LA10SL	100	30	90	142	150	16.8	21.0	2890	61	2.0	0.88	96	-	-	EETMOS3		
			★ P15LA12SL	120	15	45	83	150	40.0	50.0	1735	38.5	2.0	1.50	95	-	-	EETMOS3		
			★ P18LA12SL	120	18	54	99	150	35.0	44.0	2090	47	2.0	1.26	95	-	-	EETMOS3		
			★ P25LA12SL	120	25	75	142	150	24.0	30.0	2900	61	2.0	0.88	96	-	-	EETMOS3		
MO-235B similar LF	G7	☒ P105LF4QL	40	105	315	168	175	2.10	2.70	4090	76	2.0	0.89	100	■	■	EETMOS4			
		☒ P105LF4QN	40	105	315	168	175	2.20	2.80	3400	60	3.0	0.89	100	■	■	EETMOS4			
		☒ P140LF4QL	40	140	560	217	175	1.17	1.42	6630	122	2.0	0.69	100	■	■	EETMOS4			
		☒ P140LF4QN	40	140	560	217	175	1.22	1.48	5530	96	3.0	0.69	100	■	■	EETMOS4			
		☒ P64LF6QL	60	64	192	168	175	4.50	5.70	4130	77	2.0	0.89	100	■	■	EETMOS4			
		☒ P64LF6QN	60	64	192	168	175	4.50	5.70	3455	60	3.0	0.89	100	■	■	EETMOS4			
		☒ P98LF6QL	60	98	392	217	175	2.50	3.20	6770	126	2.0	0.69	100	■	■	EETMOS4			
		☒ P98LF6QN	60	98	392	217	175	2.60	3.30	5650	97	3.0	0.69	100	■	■	EETMOS4			
		☒ P46LF7R5SL	75	46	138	59	175	8.2	10.3	2890	61	2.0	2.54	100	■	■	EETMOS3			
		☒ P46LF7R5SN	75	46	138	59	175	8.0	10.0	2380	48	3.0	2.54	100	■	■	EETMOS3			
		☒ P72LF7R5SL	75	72	288	66	175	4.6	5.8	4870	100	2.0	2.27	102	■	■	EETMOS3			
		☒ P72LF7R5SN	75	72	288	66	175	4.5	5.7	4080	78	3.0	2.27	102	■	■	EETMOS3			
		☒ P32LF10SL	100	32	96	59	175	15.7	19.7	2890	61	2.0	2.54	100	■	■	EETMOS3			
		☒ P32LF10SN	100	32	96	59	175	14.4	18.0	2430	48	3.0	2.54	100	■	■	EETMOS3			
		☒ P50LF10SL	100	50	200	66	175	9.0	11.3	4900	102	2.0	2.27	102	■	■	EETMOS3			
		☒ P50LF10SN	100	50	200	66	175	8.3	10.4	4130	80	3.0	2.27	102	■	■	EETMOS3			
		☒ P25LF12SL	120	25	75	59	175	23.0	29.0	2930	61	2.0	2.54	100	■	■	EETMOS3			
		☒ P25LF12SN	120	25	75	59	175	21.0	27.0	2430	48	3.0	2.54	100	■	■	EETMOS3			
		☒ P40LF12SL	120	40	160	66	175	13.0	16.3	5000	102	2.0	2.27	102	■	■	EETMOS3			
		☒ P40LF12SN	120	40	160	66	175	12.3	15.4	4075	80	3.0	2.27	102	■	■	EETMOS3			
		☒ P24B4SB	40	24	72	20	150	13.1	16.4	710	15	2.0	6.28	320	-	-	EETMOS3			
		☒ P54B4SN	40	54	216	44	150	4.8	6.0	1740	32	3.0	2.84	320	-	-	EETMOS3			
TO-252AA FB	G2-1																			
		TO-252AB similar SC-63 FE	G3-2																	

☒ : New product ★ : Under development *1 : Rth(j-a) ■ : Please contact us.

POWER MOSFETS



POWER MOSFETs

EETMOS Series (Nch Single)

Surface Mount												Remarks
Package	JEDEC Code JEITA Code House Name	Fig.	Id [A]	V _{DS} [V]						150		
				40	50	55	60	75	100			
	TO-263AB-1 FG	H4	32							P32FG15SL		
			80				P80FG6EAL	P80FG7R5EN				
			85				P85FG6EAL					
			90			P90FG5R5SL						
			94			P94FG5R5SL						
	TO-263AB-1 FH	H3	80		P80FH5ENK							
			100	P100FH4ENK								
	SC-83 similar FP	H5	70							P70FP12SNK		
			88							P88FP10SNK		
			100							P100FP12SNK		
			126							P126FP10SNK		
			153				P153FP6SNK					
			168					P168FP7R5SNK				
			175			P175FP4SNK						
180			P180FP4SNK		P180FP6SNK							
	TO-263SC FZ-7p	H7	211							P211FZ4QNK		
			240									P240FZ4QLA

■ : New product ★ : Under development

THD (Through Hole Device)

THD (Through Hole Device)												Remarks
Package	JEDEC Code JEITA Code House Name	Fig.	Id [A]	V _{DS} [V]						120		
				40	50	60	70	75	100			
	SC-91 FTO-220AG	J8-2	22							P22F10SN		
			32							P32F12SN		
			34			P34F6EL						
			40							P40F10SN		
			42			P42F6EN				P40F12SN		
			50							P50F10SN		
			55			P55F6EN						
			66							P66F7R5SN		
			70			P70F5EN				P70F7R5EN		
			82							P82F7R5SN		
			86			P86F6SN						
	TO-220AB SC-46 FA	J5	100							P100FA7R5EN		

Refer to P49 for Surface Mount.

EETMOS Series (Nch Single)

Surface Mount																	
Package		Type No.	Absolute Maximum Ratings					Electrical Characteristics						Weight (mg)	Based on AEC-Q101	Automotive	Series
JEDEC Code JEITA Code House Name	Fig.		V _{DS} [V]	I _D [A]	I _{DP} [A]	P _T [W]	T _{ch} [°C]	R _{DS(ON)} (typ) [mΩ]	R _{DS(ON)} (max) [mΩ]	C _{iss} (typ) [pF]	Q _g (typ) [nC]	V _{th} (typ) [V]	R _{th(jc)} (max) [°C/W]				
TO-263AB FG	H4	P90FG5R5SL	55	90	360	128	150	3.0	3.8	5130	106	2.0	0.97	1450	-	-	EETMOS3
		P94FG5R5SL	55	94	376	156	150	2.5	3.2	7170	140	2.0	0.80	1450	-	-	EETMOS3
		P80FG6EAL	60	80	320	128	150	3.6	4.9	4700	90	2.0	0.97	1440	-	-	EETMOS2
		P85FG6EAL	60	85	340	156	150	3.2	4.3	5700	105	2.0	0.80	1440	-	-	EETMOS2
		P80FG7R5EN	75	80	320	128	150	5.1	6.4	4100	67	3.0	0.97	1450	-	-	EETMOS2
		P32FG15SL	150	32	96	100	150	32.0	40.0	3530	72	2.0	1.25	1450	-	-	EETMOS3
TO-263AB-1 FH	H3	P100FH4ENK	40	100	400	175	150	1.6	2.0	5500	100	3.0	0.71	1510	-	○	EETMOS2
		P80FH5ENK	50	80	320	128	150	3.0	3.8	4000	70	3.0	0.97	1510	-	○	EETMOS2
SC-83 similar FP	H5	P175FP4SNK	40	175	700	178	175	1.3	1.6	5900	116	3.0	0.84	1580	○	○	EETMOS3
		P180FP4SNK	40	180	720	238	175	0.95	1.15	9220	160	3.0	0.63	1580	-	○	EETMOS3
		P153FP6SNK	60	153	612	178	175	2.4	3.0	6070	105	3.0	0.84	1570	-	○	EETMOS3
		P180FP6SNK	60	180	720	238	175	1.6	2.0	9380	158	3.0	0.63	1580	-	○	EETMOS3
		P168FP7R5SNK	75	168	672	238	175	2.2	2.8	9600	155	3.0	0.63	1580	-	○	EETMOS3
		P88FP10SNK	100	88	352	178	175	6.1	7.6	6130	108	3.0	0.84	1570	-	○	EETMOS3
		P126FP10SNK	100	126	504	238	175	3.8	4.8	9500	160	3.0	0.63	1580	-	○	EETMOS3
		P70FP12SNK	120	70	280	178	175	8.9	11.1	6100	109	3.0	0.84	1570	-	○	EETMOS3
TO-263SC FZ-7p	H7	P211FZ4QMK	40	211	752	178	175	1.1	1.38	8550	145	4.0	0.84	1523.9	-	-	EETMOS4
		P240FZ4QLA	40	240	720	178	175	1.03	1.29	9675	171	2.0	0.84	1523.9	-	-	EETMOS4

■ : New product ★ : Under development

THD (Through Hole Device)

THD (Through Hole Device)																	
Package		Type No.	Absolute Maximum Ratings					Electrical Characteristics						Weight (mg)	Based on AEC-Q101	Automotive	Series
JEDEC Code JEITA Code House Name	Fig.		V _{DS} [V]	I _D [A]	I _{DP} [A]	P _T [W]	T _{ch} [°C]	R _{DS(ON)} (typ) [mΩ]	R _{DS(ON)} (max) [mΩ]	C _{iss} (typ) [pF]	Q _g (typ) [nC]	V _{th} (typ) [V]	R _{th(jc)} (max) [°C/W]				
SC-91 FTO-220AG	J8-2	P70F5EN	50	70	280	53	150	2.7	3.2	5500	100	3.0	2.35	1580	-	-	EETMOS2
		P34F6EL	60	34	136	35	150	9.0	11.0	1960	41	2.0	3.55	1580	-	-	EETMOS2
		P42F6EN	60	42	168	40	150	6.7	8.4	2540	47	3.0	3.12	1580	-	-	EETMOS2
		P55F6EN	60	55	220	44	150	4.4	5.5	4100	73	3.0	2.84	1580	-	-	EETMOS2
		P86F6SN	60	86	344	58	150	2.4	3.0	9380	181	3.0	2.15	1590	-	-	EETMOS3
		P66F7R5SN	75	66	264	51	150	4.0	5.0	6070	115	3.0	2.45	1590	-	-	EETMOS3
		P70F7R5EN	75	70	280	53	150	3.8	4.8	5720	105	3.0	2.35	1540	-	-	EETMOS2
		P82F7R5SN	75	82	328	58	150	3.0	3.8	9600	168	3.0	2.15	1590	-	-	EETMOS3
		P22F10SN	100	22	66	35	150	22.0	28.0	1700	34	3.0	3.55	1590	-	-	EETMOS3
		P40F10SN	100	40	160	44	150	8.5	10.7	4500	92	3.0	2.84	1580	-	-	EETMOS3
		P50F10SN	100	50	200	51	150	6.9	8.7	5880	114	3.0	2.45	1580	-	-	EETMOS3
		P32F12SN	120	32	128	44	150	12.4	15.5	4540	92	3.0	2.84	1580	-	-	EETMOS3
		P40F12SN	120	40	160	51	150	9.5	11.9	6000	117	3.0	2.45	1580	-	-	EETMOS3
		TO-220AB SC-46 FA	J5	P100FA7R5EN	75	100	400	140	150	4.2	5.0	5720	104	3.0	0.89	1950	-

Refer to P49 for the features of the series.

POWER MOSFETs

The Hi-PotMOS series are MOSFETs with a high breakdown strength, and they are 100% screened using di/dt & avalanche testing.

Series	Feature
HP2 (Hi-PotMOS2)	High breakdown resistance, Avalanche rated, di/dt inspection(all parts)
VX	Automotive qualified, Avalanche rated, di/dt inspection(all parts), High Breakdown resistance

HP2 • VX Series (Nch Single)

Package	JEDEC Code JEITA Code House Name	Fig.	Id [A]	Vbss [V]					Remarks
				250/280/300	400	500/525	600	900	
	TO-252AA - FB	G2-1	0.5					P0R5B60HP2	
			1			P1B52HP2			
			1.5		P1R5B40HP2				
			2				P2B60HP2F		
			2.5			P2R5B52HP2F			
			3	P3B28HP2					
			4		P4B40HP2		P4B60HP2F		
			5			P5B52HP2			
			6	P6B28HP2 P8B28HP2 P8B30HP2	P6B40HP2	P6B52HP2			
			9	★P9B30HP2F	P9B40HP2				
10	P10B28HP2								
	TO-252AB similar SC-63 FE	G3-2	1					P1FE90VX3	
			2				P2FE60VX5K		
	TO-263AB-1 - FH	H3	7					P7FH60HP2	
			15				P15FH60HP2		
	TO-263AB-1 - FH	H3	20			P20FH50HP2			
			36	P36FH28HP2					

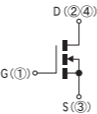

HP2 • VX Series (Nch Single)

Surface Mount		Package	Fig.	Type No.	Absolute Maximum Ratings				Electrical Characteristics					Body Diode trr (typ) [ns]	Weight (mg)	Based on AEC-Q101	Automotive	Series			
JEDEC Code	JEITA Code				House Name	Vbss [V]	Id [A]	Pt [W]	Tch [°C]	Rds(ON) (typ) [Ω]	Rds(ON) (max) [Ω]	Ciss (typ) [pF]	Qg (typ) [nC]						Vth (typ) [V]	Rth(jc) (max) [°C/W]	
		TO-252AA - FB	G2-1	P3B28HP2	280	3	35	150	1.70	2.00	120	3.6	3.75	3.55		320	-	-	HP2		
				P6B28HP2	280	6	35	150	0.66	0.85	240	5.7	3.75	3.55		320	-	-	HP2		
				P8B28HP2	280	8	54	150	0.38	0.50	400	9.8	3.75	2.31		320	-	-	HP2		
				P8B30HP2	300	8	54	150	0.42	0.50	400	9.8	3.75	2.31		320	-	-	HP2		
				★P9B30HP2F	300	9	54	150	0.44	0.55	400	9.8	3.25	2.31	70	320	-	-	HP2		
				P10B28HP2	280	10	70	150	0.30	0.40	500	11.4	3.75	1.78		330	-	-	HP2		
				P1R5B40HP2	400	1.5	35	150	4.20	5.00	120	3.9	3.75	3.55		320	-	-	HP2		
				P4B40HP2	400	4	35	150	1.54	1.90	245	6.5	3.75	3.55		320	-	-	HP2		
				P6B40HP2	400	6	54	150	0.84	1.05	400	10.0	3.75	2.31		320	-	-	HP2		
				P9B40HP2	400	9	40	150	0.65	0.80	575	14.5	3.75	3.12		320	-	-	HP2		
				P1B52HP2	525	1	35	150	6.00	7.20	125	4.3	3.75	3.55		320	-	-	HP2		
				P2R5B52HP2F	525	2.5	35	150	2.50	3.20	240	6.7	3.25	3.55	52	320	-	-	HP2		
				P5B52HP2	525	5	54	150	1.40	1.70	400	10.5	3.75	2.31		320	-	-	HP2		
				P6B52HP2	525	6	70	150	1.10	1.35	520	15.0	3.75	1.78		320	-	-	HP2		
				P0R5B60HP2	600	0.5	35	150	8.30	10.00	120	4.3	3.75	3.55		320	-	-	HP2		
				P2B60HP2F	600	2	35	150	3.40	4.20	240	6.8	3.25	3.55	52	320	-	-	HP2		
				P4B60HP2F	600	4	70	150	1.60	1.90	520	13.0	3.25	1.78	75	320	-	-	HP2		
				TO-252AB similar SC-63 FE	G3-2	P1FE90VX3	900	1	36	150	9.50	14.00	193	10.8	3.50	3.40		320	-	○	VX
						P6FE25VX5K	250	6	27	150	0.58	0.70	250	10.0	3.75	4.62		320	-	○	VX
						P2FE60VX5K	600	2	27	150	3.40	4.20	247	12.0	3.75	4.62		320	-	○	VX
		TO-263AB-1 - FH	H3	P36FH28HP2	280	36	175	150	0.08	0.12	1730	35.0	3.75	0.71		1510	-	-	HP2		
				P20FH50HP2	500	20	175	150	0.29	0.36	1735	40.0	3.75	0.71		1510	-	-	HP2		
				P7FH60HP2	600	7	128	150	0.88	1.05	810	19.0	3.75	0.97		1510	-	-	HP2		
				P15FH60HP2	600	15	175	150	0.41	0.49	1750	37.0	3.75	0.71		1510	-	-	HP2		

★ : Under development

★ : Under development

THD (Through Hole Device)

Package	JEDEC Code JEITA Code House Name	Fig.	Id [A]	Vbss [V]					Remarks
				280	400	500	525	600	
	- SC-91 FTO-220AG	J8-2	3					P3F60HP2	
			4					P4F60HP2	
			5			P5F50HP2 P5F50HP2F		P5F60HP2	
			6			P6F50HP2			
			7					P7F60HP2	
			8	P8F28HP2		P8F50HP2			
			10			P10F50HP2		P10F60HP2	
			12					P12F60HP2	
			13	P13F28HP2		P13F50HP2			
			15			P15F50HP2		P15F60HP2 P15F60HP2F	
			17	P17F28HP2					
			20			P20F50HP2			
			21	P21F28HP2					
26	P26F28HP2								
36	P36F28HP2								
	- SC-91 FTO-220A	J7-2	23					P23F40HP2FM	

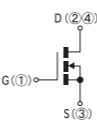
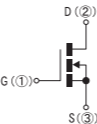

THD (Through Hole Device)

Package		Package	Fig.	Type No.	Absolute Maximum Ratings				Electrical Characteristics					Body Diode trr (typ) [ns]	Weight (mg)	Based on AEC-Q101	Automotive	Series	
JEDEC Code	JEITA Code				House Name	Vbss [V]	Id [A]	Pt [W]	Tch [°C]	Rds(ON) (typ) [Ω]	Rds(ON) (max) [Ω]	Ciss (typ) [pF]	Qg (typ) [nC]						Vth (typ) [V]
		- SC-91 FTO-220AG	J8-2	P8F28HP2	280	8	52.5	150	0.38	0.50	400	9.8	3.75	2.38		320	-	-	HP2
				P13F28HP2	280	13	65	150	0.23	0.30	630	15.0	3.75	1.92		1590	-	-	HP2
				P17F28HP2	280	17	79	150	0.17	0.23	830	19.5	3.75	1.58		1590	-	-	HP2
				P21F28HP2	280	21	85	150	0.13	0.18	1000	20.5	3.75	1.47		1590	-	-	HP2
				P26F28HP2	280	26	90	150	0.11	0.15	1200	24.5	3.75	1.39		1590	-	-	HP2
				P36F28HP2	280	36	95	150	0.08	0.12	1730	35.0	3.75	1.32		1590	-	-	HP2
				P5F50HP2	500	5	52.5	150	1.30	1.60	400	10.5	3.75	2.38		1540	-	-	HP2
				P5F50HP2F	500	5	52.5	150	1.38	1.65	405	10.5	3.25	2.38	70	1580	-	-	HP2
				P6F50HP2	500	6	62.5	150	1.00	1.25	500	12.5	3.75	2.00		1540	-	-	HP2
				P8F50HP2	500	8	65	150	0.80	1.00	610	15.0	3.75	1.92		1540	-	-	HP2
				P10F50HP2	500	10	79	150	0.60	0.75	820	20.0	3.75	1.58		1540	-	-	HP2
				P13F50HP2	500	13	85	150	0.48	0.60	1050	25.0	3.75	1.47		1540	-	-	HP2
				P15F50HP2	500	15	90	150	0.40	0.50	1340	27.0	3.75	1.39		1540	-	-	HP2
				P20F50HP2	500	20	95	150	0.29	0.36	1735	40.0	3.75	1.32		1540	-	-	HP2
				P3F60HP2	600	3	52.5	150	1.92	2.30	400	10.0	3.75	2.38		1540	-	-	HP2
				P4F60HP2	600	4	62.5	150	1.50	1.80	505	12.5	3.75	2.00		1580	-	-	HP2
				P5F60HP2	600	5	65	150	1.17	1.40	615	15.0	3.75	1.92		1580	-	-	HP2
				P7F60HP2	600	7	79	150	0.88	1.05	810	19.0	3.75	1.58		1580	-	-	HP2
				P10F60HP2	600	10	85	150	0.67	0.80	1040	23.0	3.75	1.47		1540	-	-	HP2
				P12F60HP2	600	12	90	150	0.56	0.67	1230	26.5	3.75	1.39		1540	-	-	HP2
		P15F60HP2	600	15	95	150	0.41	0.49	1750	37.0	3.75	1.32		1540	-	-	HP2		
		P15F60HP2F	600	15	95	150	0.44	0.53	1720	34.0	3.25	1.32	88	1590	-	-	HP2		
		- SC-91 FTO-220A	J7-2	P23F40HP2FM	400	23	104	150	0.17	0.24	1620	46.0	3.25	1.20	68	2180	-	-	HP2
		- TO-247AD - MTO-3P	K4-2	P85W28HP2F	280	85	310	150	0.035	0.045	4440	90.0	3.45	0.40	76	6170	-	-	HP2
		- TO-247AD - MTO-3PV	K7-4	■ P30W60HP2V	600	30	310	150	0.185	0.23	3935	70.0	3.75	0.40		6133	-	-	HP2

■ : New product

POWER MODULES

Power Modules include combinations of various power semiconductors.

They are easy to design, reduce the number of components needed in the device, are suitable for device downsizing, and mitigate heat-dissipation concerns.

At Shindengen, a multitude of packages allow us to meet customer needs of MOSFET, diodes, and other products.

Semi customizable support and customizable package design support are available.

Transfer Type Sample

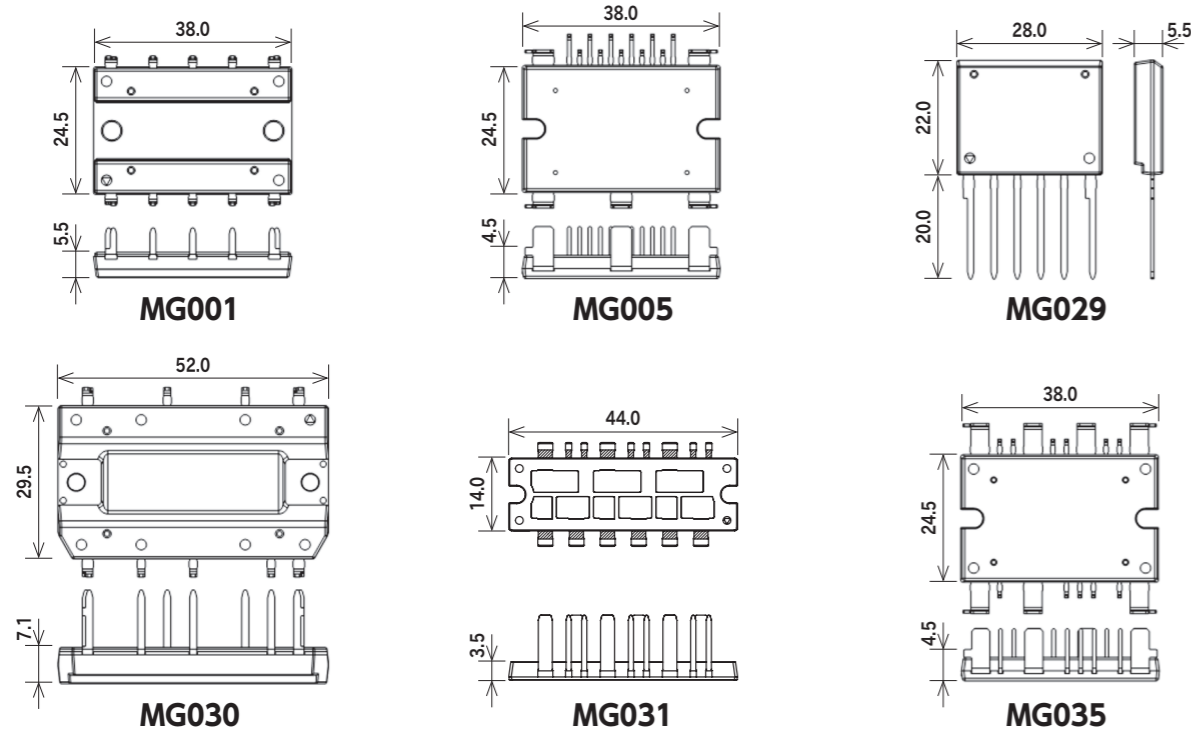

Potting Type Sample

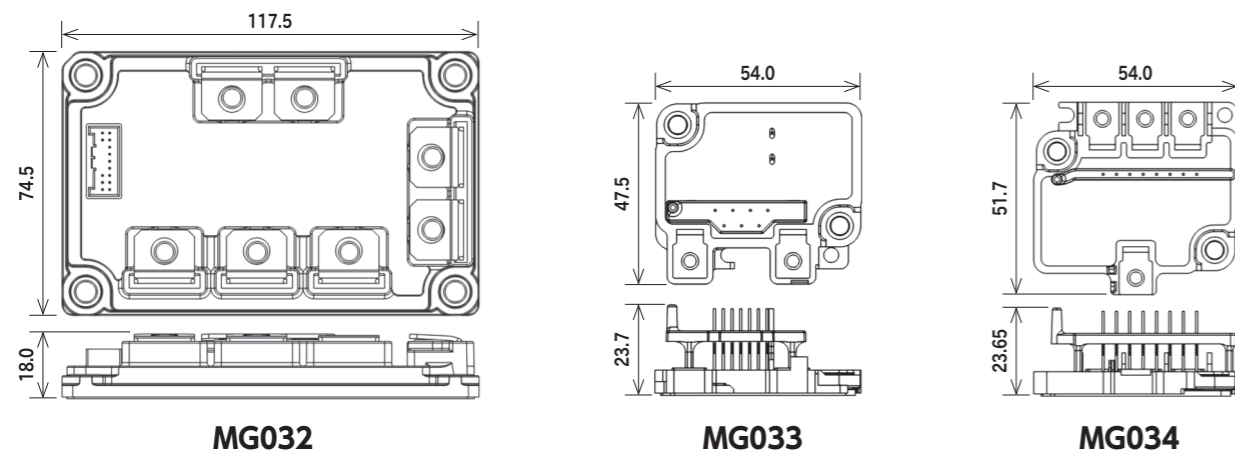

CB Module Series

Converter + Brake Modules

Type No.	Package		Converter Diode				Brake IGBT				Brake FRD				Weight (mg)	UL	Automotive				
			Absolute Maximum Ratings		Electric Characteristics		Absolute Maximum Ratings		Electric Characteristics		Absolute Maximum Ratings		Electric Characteristics								
	JEDEC Code	JEITA Code	Fig.	V _{RRM} [V]	I _F (AV) [A]	Conditions T _C [°C]	V _F (max) [V]	Conditions I _F [A]	V _{CE5} [V]	I _C [A]	V _{CE} (sat) (typ) [V]	Conditions I _C [A]	V _{RRM} [V]	I _F (AV) [A]				Conditions T _C [°C]	V _F (max) [V]	Conditions I _F [A]	t _{rr} (max) [ns]
MG020200	-	-	F4	600	20.0	137	1.05	7.0	600	28.0	2.10	15.0	600	3.0	137	1.65	3.0	50	7101: 10 7102: 10.19	UL	-
MG020201	MG001	-	F4	600	30.0	136	1.05	10.0	600	30.0	2.00	30.0	600	3.0	137	1.65	3.0	50	7101: 10 7102: 10.19	UL	-

UL : UL recognize(UL File No.E142422)

Equivalent Circuit Schematic

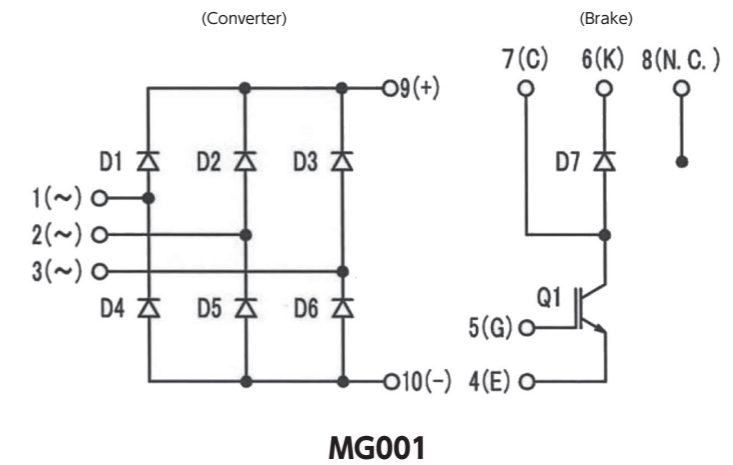

INV Module Series

Inverter Modules

Type No.	Package		Absolute Maximum Ratings					Electric Characteristics						Weight (mg)	UL	Automotive	
			V _{DSS} [V]	I _D [A]	I _{DP} [A]	P _T [W]	T _{ch} [°C]	R _{DS(ON)} (typ) [mΩ]	R _{DS(ON)} (max) [mΩ]	C _{iss} (typ) [pF]	Q _g (typ) [nC]	V _{th} (typ) [V]	R _{th(j-c)} (max) [°C/W]				
MG032A4207R5A	-	-	F6	75	420	840	500	150	-	0.98	80120	505	3.0	0.25	340	-	-
MG032B420010A	MG032	-	F6	100	420	840	500	150	0.99	1.37	91800	500	3.0	0.25	340	-	-
MG031B090004A	-	-	F5	40	90	360	125	175	2.34	3.20	4180	76	2.0	1.2	7.7	-	-
MG031G148004A	MG031	-	F5	40	148	592	128	150	1.75	2.20	5330	96	3.0	0.97	7.7	-	-

■ : New product

Equivalent Circuit Schematic

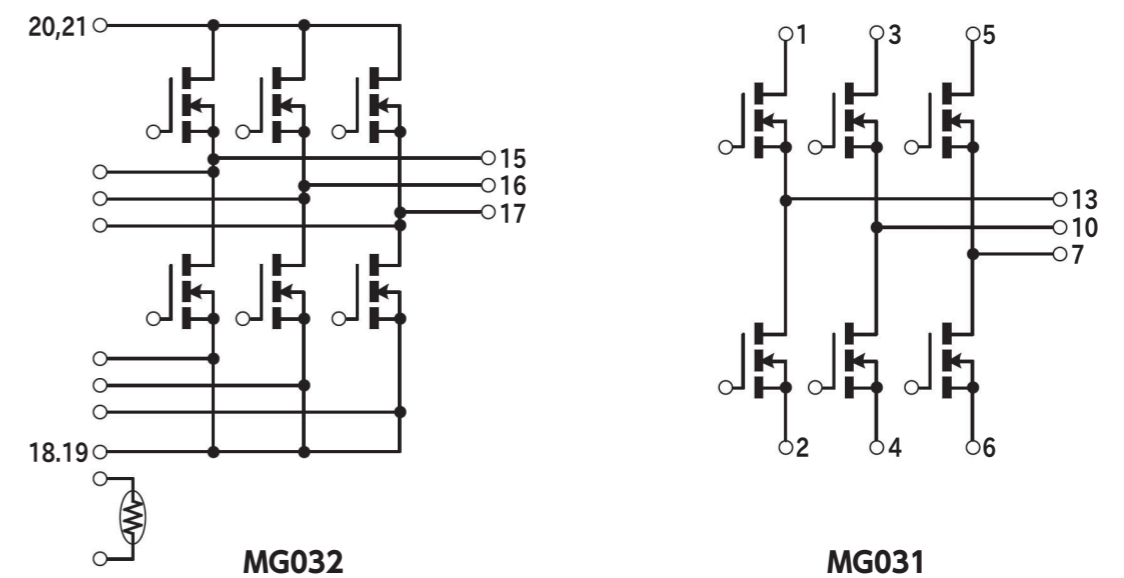

POWER ICs

Line up

IC for LED Lighting

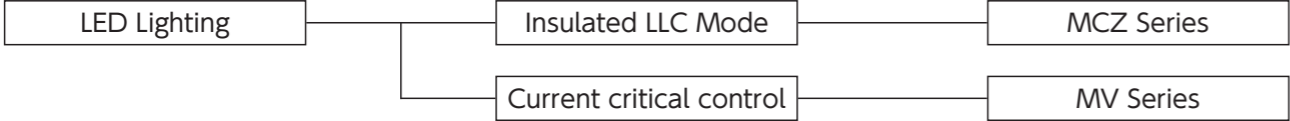

IC for Power Supply

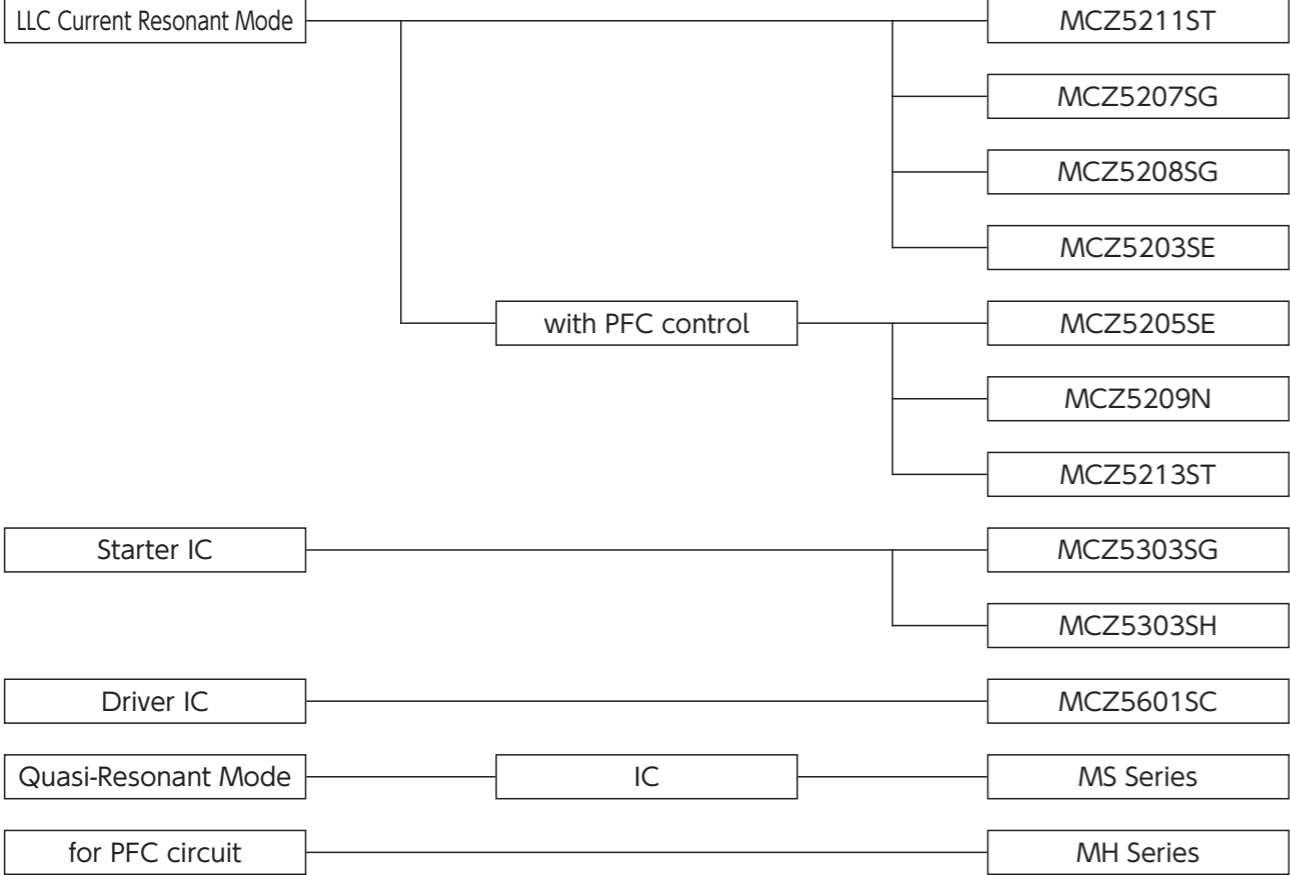



IC for LED Lighting

Quasi-Resonant Power Supply ICs for LED Lighting : MV Series

■ Outline The MV series has a specialized function for LED lighting with PWM & Linear dimming that operates quasi-resonance without auxiliary winding. On and off width modulation function allows for smooth deep dimming of 1% or less.

MV Series

Quasi-Resonant Power Supply ICs for LED Lighting												
Package		Type No.	HV Startup	Vcc [V]	Output	ON/OFF	Built-in Regulator Voltage [V]	Linear Dimming	PWM Dimming	Weight (mg)	Automotive	
JEDEC Code JEITA Code House Name	Fig.											
	-	SOP8J	L2	MV1001SC	Yes	9 to 16	1ch	-	Yes	Yes	77	-
			MV1002SC	No	77						-	
			MV1011SC	Yes	77						-	
			MV1012SC	No	77						-	
	-	SOP16	L5	MV2002SG	No	10 to 16	2ch	Cont. by REF Voltage	Yes	Yes	150	-
			MV2052SG	No	150						-	

POWER ICs

IC for Power Supply

LLC Current Resonant Mode Controller ICs for Bridge Converter : MCZ Series

- Outline** The MCZ series is an advanced symmetric LLC current resonant mode controller for bridge converters. Symmetric LLC resonant converter applications are greatly expanding due to their extremely high efficiency and low noise characteristics. A low level THD^(*) is installed for optimality in LED applications.

*1 : Total Harmonic Distortion

Starter ICs with Built-in Burst Function : MCZ5303

- Outline** A dedicated IC that provides a low power consumption start-up for circuits without an IC. Low power consumption standby is possible due to the ON/OFF Control IC with burst function. It is especially effective when used in conjunction with the LLC current resonance power supply.

High/Low Side Driving IC

- Outline** A driving IC for MOSFET and IGBT power devices. With built-in high-withstand voltage components, it can be used for a variety of uses such as inverter and power supply, etc.

Low Power Standby Quasi-Resonant Power Supply ICs : MS Series

- Outline** The MS series consumes much less power in standby mode than conventional MR series. The ICs incorporate various functions to make it more user-friendly and easier to design a power supply with fewer external components.

PFC ICs : MH Series

- Outline** The MH series is a PFC circuit control IC which enables multistage interleave. An efficient, high power operation is possible by utilizing a slave IC composed of multistage interleave and a master IC that can be used alone.

MCZ Series

LLC Current Resonant Mode Controller ICs for Bridge Converter

Package		Type No.	Type	HV Startup	High-side Drive	Vcc (max) [V]	Vin Sensing	Burst Mode	Maximum Frequency [kHz]	Low THD control	Capacitive Mode Protection	Over Voltage Protection	Over Current Protection	Weight (mg)	Automotive						
JEDEC Code	Fig.																				
-	SOP18	MCZ5211ST	LLC Current Resonant Mode	Yes	Yes	35	Yes	Yes	500	No	Yes	Latch	Timer Latch	260	-						
		MCZ5213ST	LLC Current Resonant Mode with PFC Control	No				No	300	Yes				260	-						
-	SOP24	MCZ5209SN	LLC Current Resonant Mode with PFC Control	Yes				Yes	35	Yes				Yes	300	No	Yes	Latch	Timer Latch	320	-
		MCZ5207SG	LLC Current Resonant Mode	No										Yes	300	No				152	-
-	SOP16	MCZ5208SG	LLC Current Resonant Mode	No				Yes	35	Yes				Yes	500	No	Yes	Latch	Timer Latch	152	-
		MCZ5205SE	LLC Current Resonant Mode with PFC Control	No										No	300	No				320	-
-	SOP22	MCZ5205SE	LLC Current Resonant Mode with PFC Control	No				Yes	35	Yes				No	300	No	Yes	Latch	Timer Latch	320	-
		MCZ5203SE	LLC Current Resonant Mode	No										No	300	No				320	-

■ : New product

Starter ICs with Built-in Burst Function

Package		Type No.	Vin Applied Voltage [V]	Vcc Output Voltage [V]	HV Startup	Vin Sensing	Burst Mode	Weight (mg)	Automotive
JEDEC Code	Fig.								
-	SOP16	MCZ5303SG	95 to 450	18.5(typ)	Yes	Yes	Yes	152	-
		MCZ5303SH				No	No	76	-

High/Low Side Driving IC

Package		Type No.	Output	High-side Floating Supply Voltage [V]	Vcc (max) [V]	Input/Output Channel	Vcc_UVLO [V]	VBS_UVLO [V]	Typ. Output Current		Weight (mg)	Automotive
JEDEC Code	Fig.								SOURCE [mA]	SINK [mA]		
-	SOP8J	MCZ5601SC	High-side/Low-side	600	22	2/2	8.2 to 9.0	7.2 to 8.0	400	400	77	-

■ : New product

MS Series

Low Power Standby Quasi-Resonant Power Supply ICs

















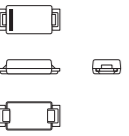
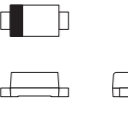
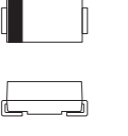
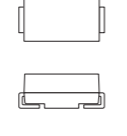
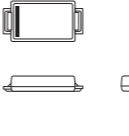
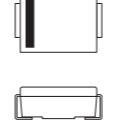
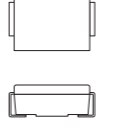
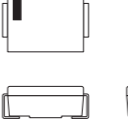

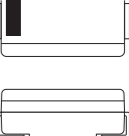
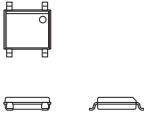
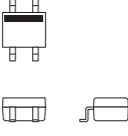
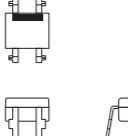
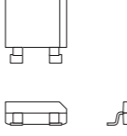
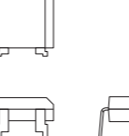
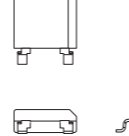
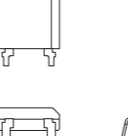
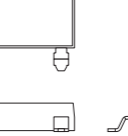
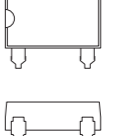
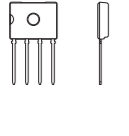
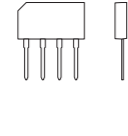
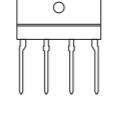
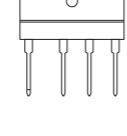
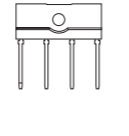
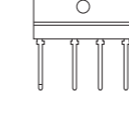
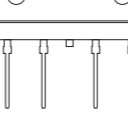
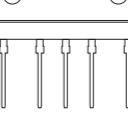
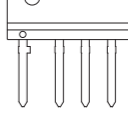
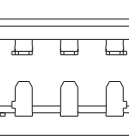
Package		Type No.	Vin [V]	Vcc [V]	Over Voltage Protection	Over Current Protection	Stand-by Operation	Bottom Skip	Weight (mg)	Automotive
JEDEC Code	Fig.									
-	SOP8/7J	MS1003SH	95 to 450	11 to 24	Vcc Latch	Timer Latch 2sec. (typ)	Auto Burst Mode/S-Stby Mode	1 skip	76	-
		MS1004SH						2 skip	76	-
-	SOP14	MS1005SK					Auto Burst Mode/UT-Stby Mode	1 skip	130	-
		MS1006SK						2 skip	130	-

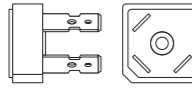
MH Series

PFC ICs

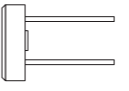
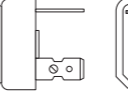
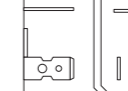
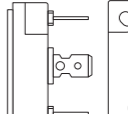
Package		Type No.	Type	Operation Mode	Vin Sensing	Vcc [V]	Zero Current detection	Diodes Short Protection	FB Open Short Protection	Over Voltage Protection	Weight (mg)	Automotive
JEDEC Code	Fig.											
-	SOP8J	MH2501SC	Current Critical Mode	Master	Unnecessary	13 to 23	Auxiliary Winding	Yes	Yes	Yes	77	-
		MH2511SC	Synchronizes with Master IC	Slave		11 to 23	-	No	No	No	77	-

OUTLINE DIMENSIONS TABLE

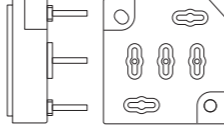
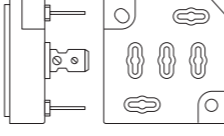
	1	2	3	4	5		6	7	8	9	10
A	A1 Package:AX057 	A2 Package:AX06 	A3 Package:AX06 	A4 Package:AX078 	A5 Package:AX10 		A6 Package:AX10 	A7 Package:AX14 			
B	B1 Package:DO-219AB similar <small>SLF</small> 	B2 Package:DO-219AA <small>M1E</small> 	B3 Package:DO-214AC <small>1E</small> 	B4 Package:DO-214AC <small>1E</small> 	B5 Package:SC-110B <small>CE</small> 		B6 Package:DO-214AA similar <small>M2E</small> 	B7 Package:DO-214AA similar <small>M2E</small> 	B8 Package:DO-214AA similar <small>M2E</small> 	B9 Package:2F 	B10 Package:2F 
C	C1 Package:SOPA-4 	C2 Package:TO-269AA <small>1Z(SMD)</small> 	C3 Package:1Z(DIP) 	C4 Package:1N(SMD) 	C5 Package:1N(DIP) 		C6 Package:1NA(SMD) 	C7 Package:1NA(DIP) 	C8 Package:1W(SMD) 	C9 Package:1W(DIP) 	
D	D1 Package:D3K 	D2 Package:2S 	D3 Package:3S 	D4 Package:5S 	D5 Package:JB 		D6 Package:JA 	D7 Package:TSB(4pin),JC(4pin) 	D8 Package:TSB(5pin),JC(5pin) 	D9 Package:JF 	D10 Package:JH 
E	E1 Package:MCP 	E2 Package:D30VC 	E3 Package:S2VB 	E4 Package:S4VB 	E5 Package:S5VB 		E6 Package:S10VB 	E7 Package:S15VB 	E8 Package:S25VB 	E9 Package:S50VB 	E10 Package:S3WB 
	11	12	13	14	15						
E	E11 Package:S10WB 	E12 Package:S15WB 	E13 Package:S20WB 	E14 Package:SVTA 	E15 Package:SVT 						

OUTLINE DIMENSIONS TABLE

OUTLINE DIMENSIONS TABLE

	1	2	3	4	5	6	7	8	9	10
F	F1 Package:Module 	F2 Package:Module 	F3 Package:Module 	F4 Package:MG001 	F5 Package:MG031 	F6 Package:MG032 				
G	G1 Package:SC-63 E-pack 	G2 Package:TO-252AA EB 	G3 Package:TO-252AB similar EE 	G4 Package:DO-277A similar EY 	G5 Package:TO-252AA similar EB 	G6 Package:LA 	G7 Package:MO-235B similar LE 			
H	H1 Package:SC-83 similar STO-220 	H2 Package:SC-83 similar ED 	H3 Package:TO-263AB-1 EH 	H4 Package:TO-263AB EG 	H5 Package:SC-83 similar EP 	H6 Package:TO-263AB EZ 	H7 Package:TO-263SC EZ-2p 			
J	J1 Package:SC-91A FTO-220(2pin) 	J2 Package:SC-91 FTO-220A(2pin) 	J3 Package:SC-91 FTO-220AG(2pin) 	J4 Package:SC-91 FTO-220G(2pin) 	J5 Package:TO-220AB EA 	J6 Package:SC-91A FTO-220(3pin) 	J7 Package:SC-91 FTO-220A(3pin) 	J8 Package:SC-91 FTO-220AG(3pin) 	J9 Package:SC-91 FTO-220G(3pin) 	
K	K1 Package:SC-93 ITO-3P(2pin) 	K2 Package:TO-247AD MTO-3PT(2pin) 	K3 Package:SC-93 ITO-3P(3pin) 	K4 Package:TO-247AD MTO-3PT(3pin) 	K5 Package:TO-247AD MTO-3PT(3pin) 	K6 Package:TO-247AD MTO-3PV 	K7 Package:TO-247AD MTO-3PV 			
L	L1 Package:SOP8 	L2 Package:SOP8J 	L3 Package:SOP8/7J 	L4 Package:SOP14 	L5 Package:SOP16 	L6 Package:SOP18 	L7 Package:SOP22 	L8 Package:SOP24 		

OUTLINE DIMENSIONS TABLE

OUTLINE DIMENSIONS

[Unit:mm]

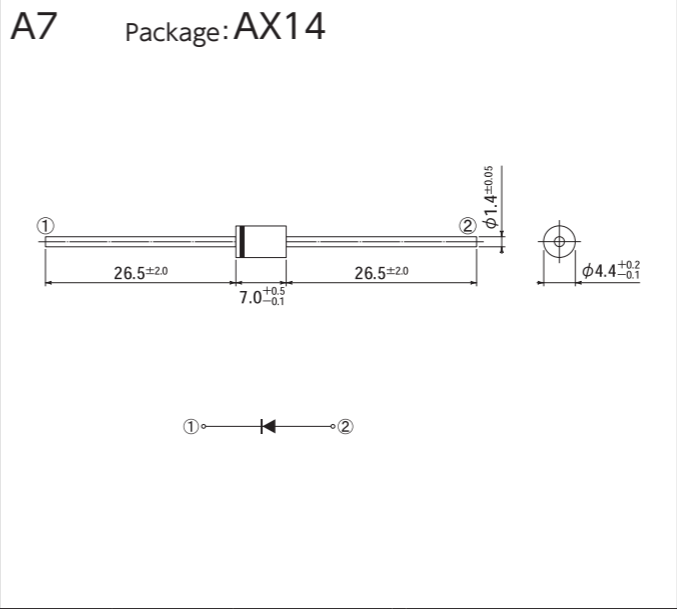
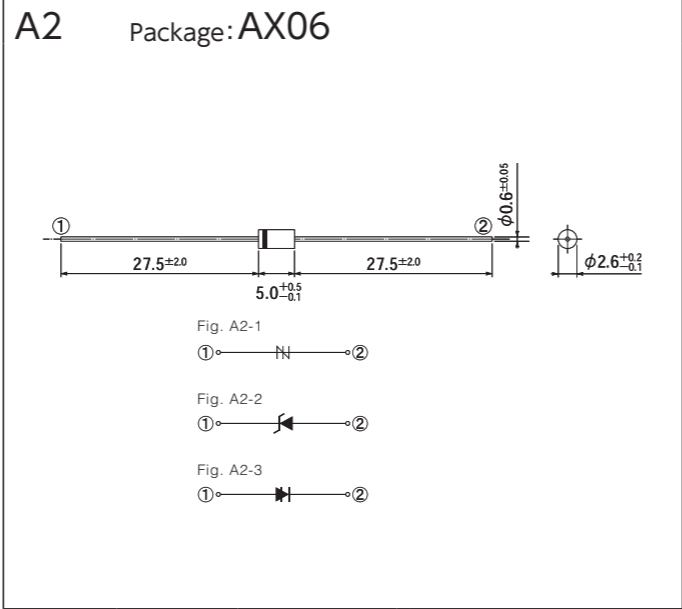
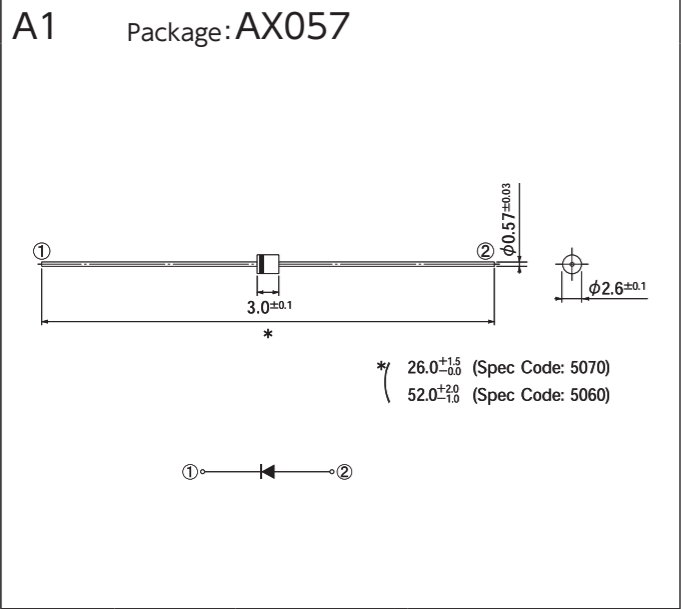

[Unit:mm]

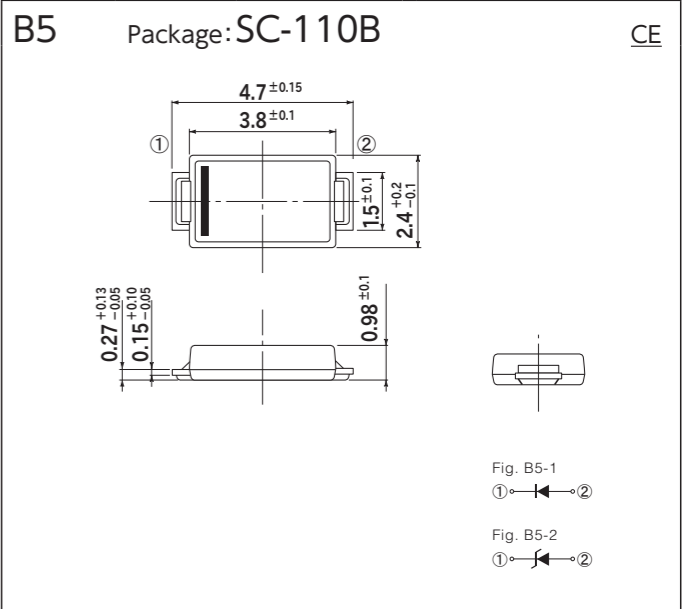
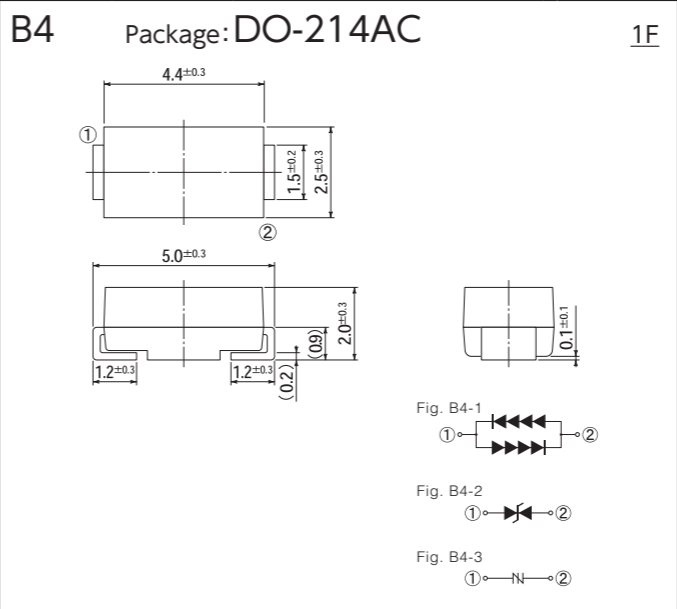
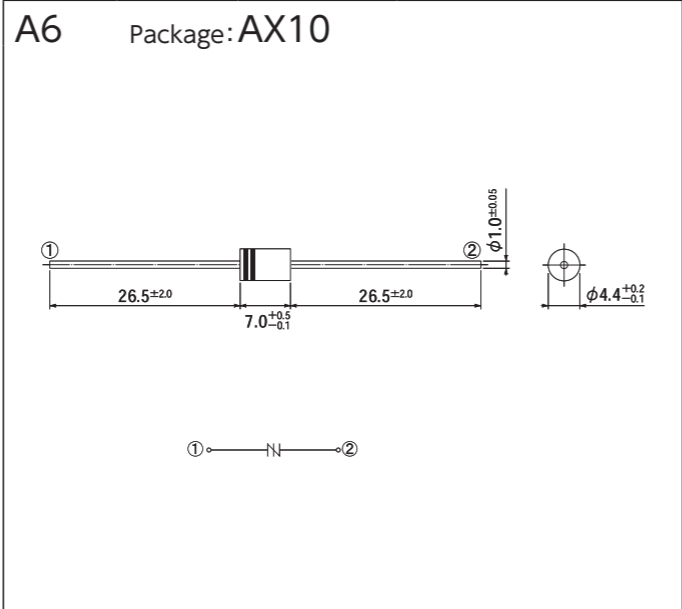
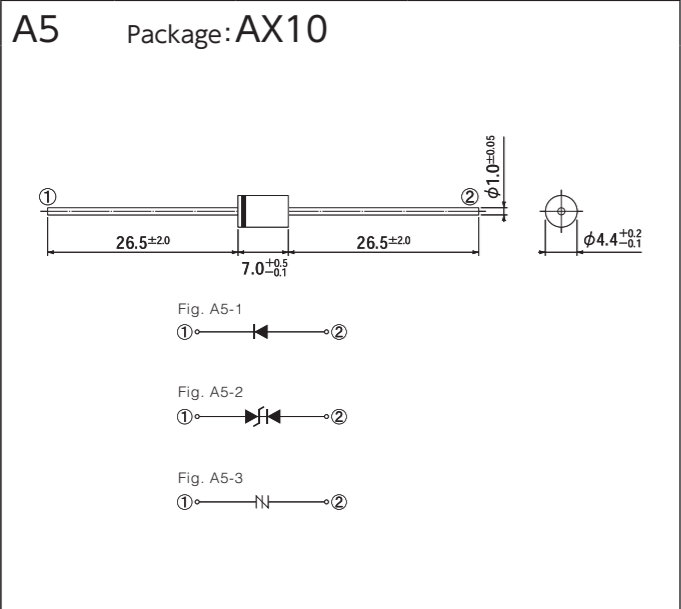
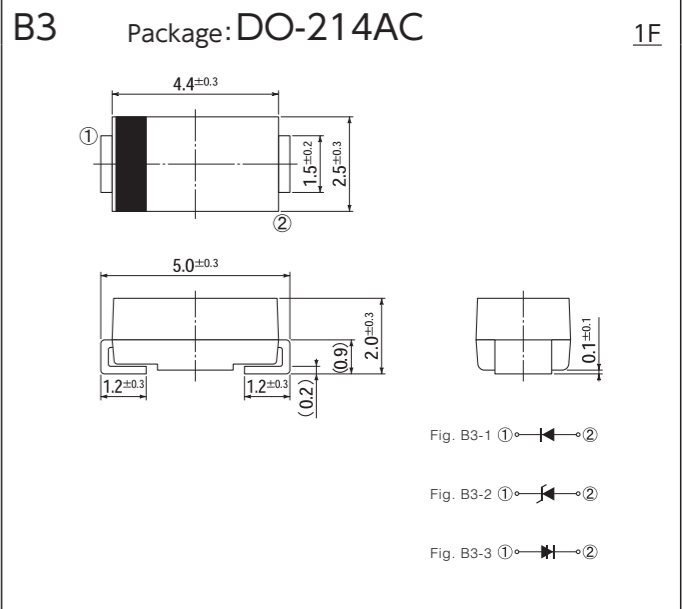
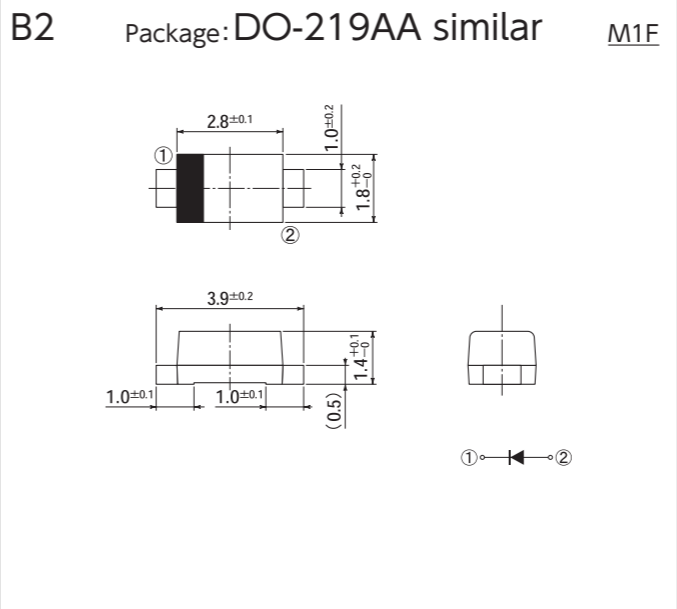
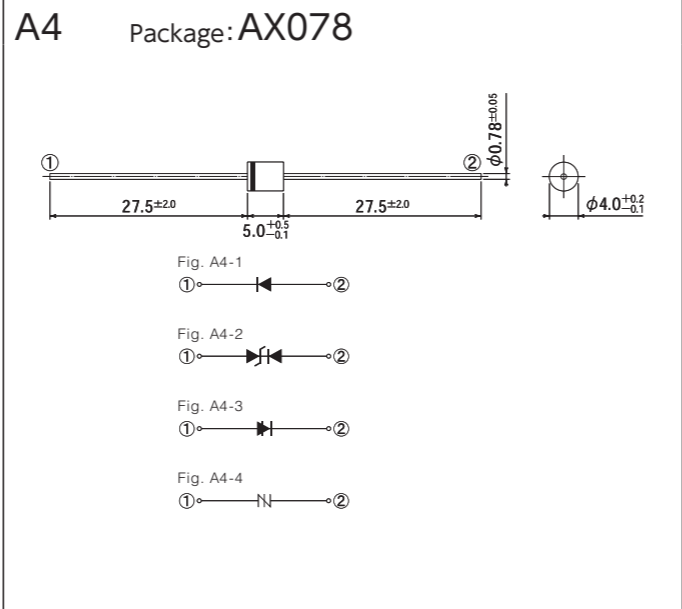
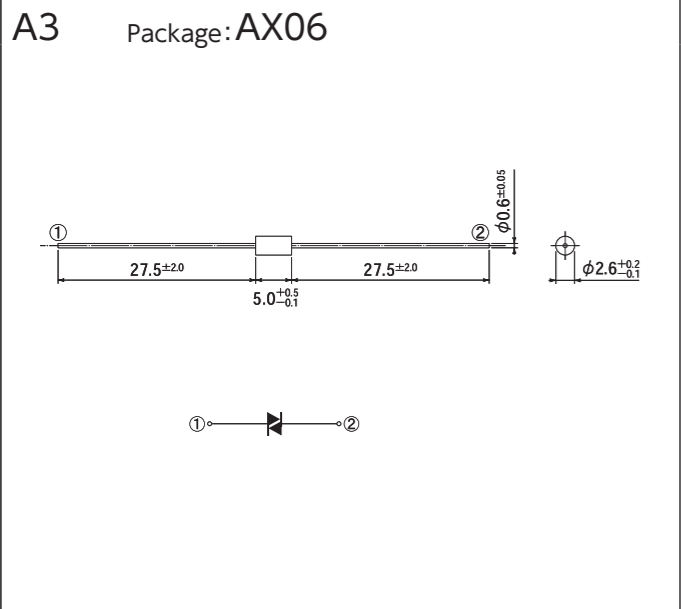
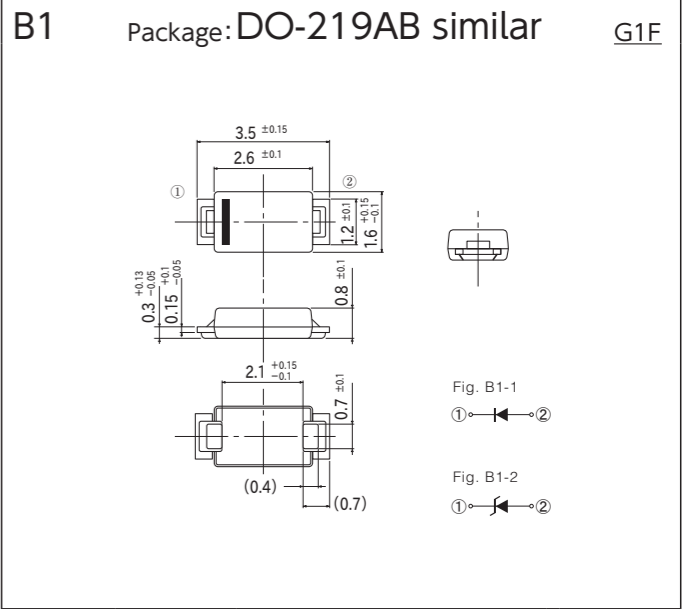

OUTLINE DIMENSIONS

[Unit:mm]

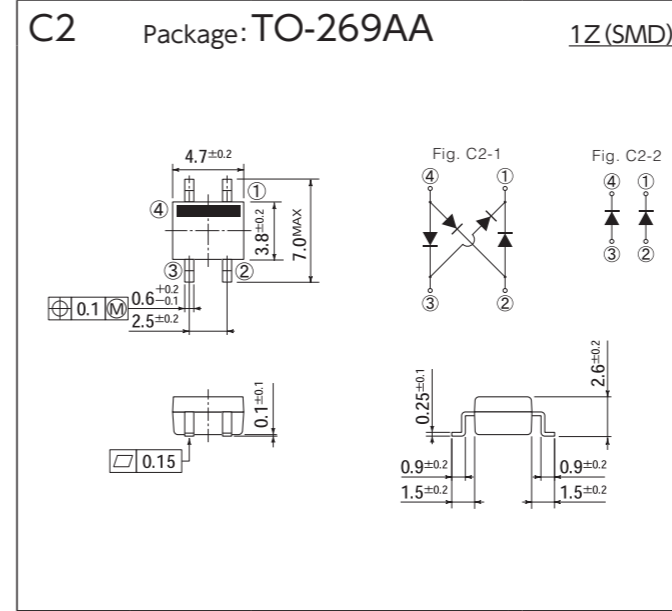
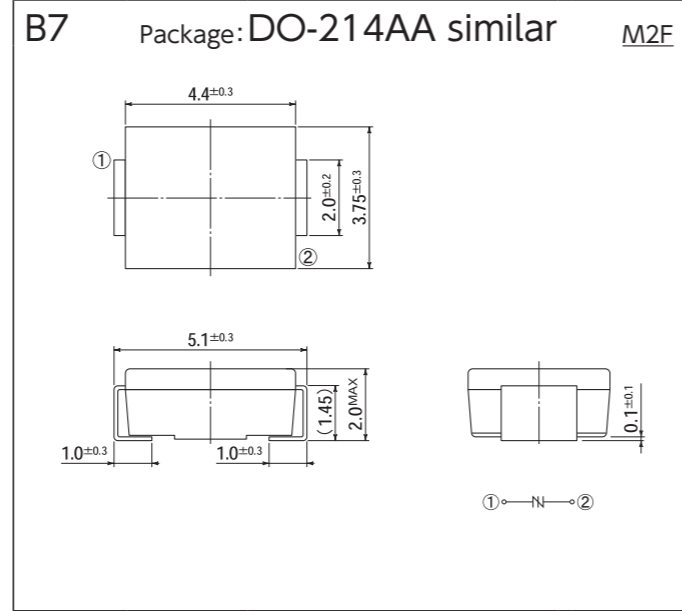
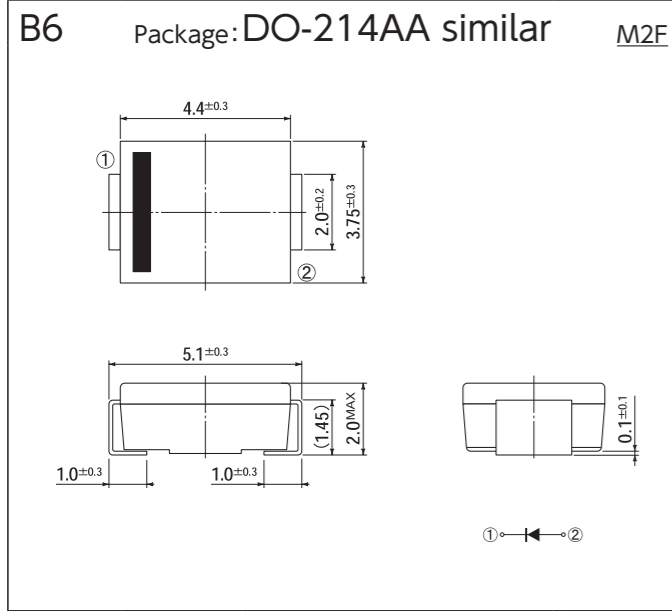

[Unit:mm]

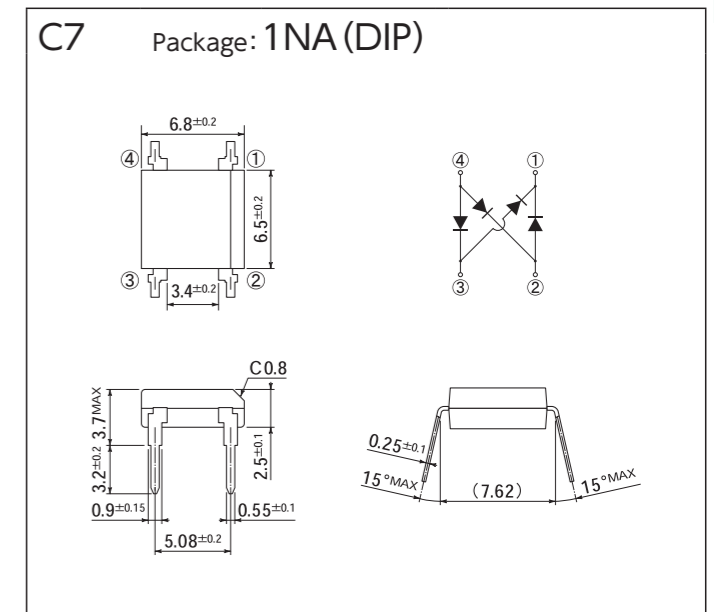
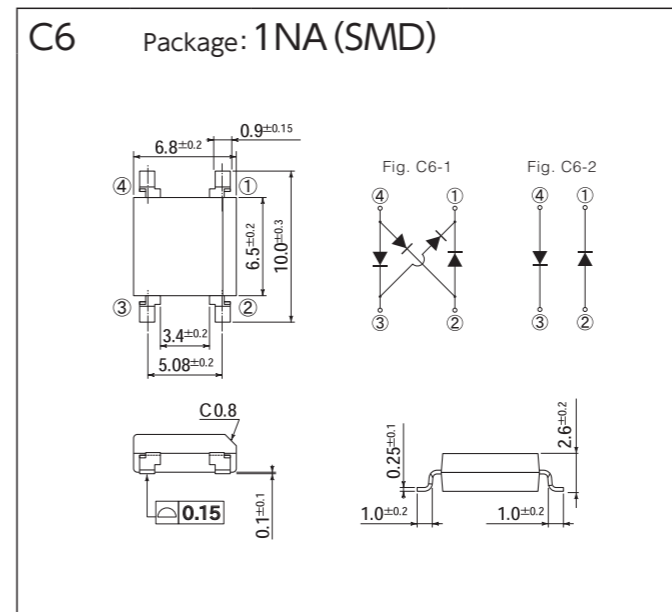
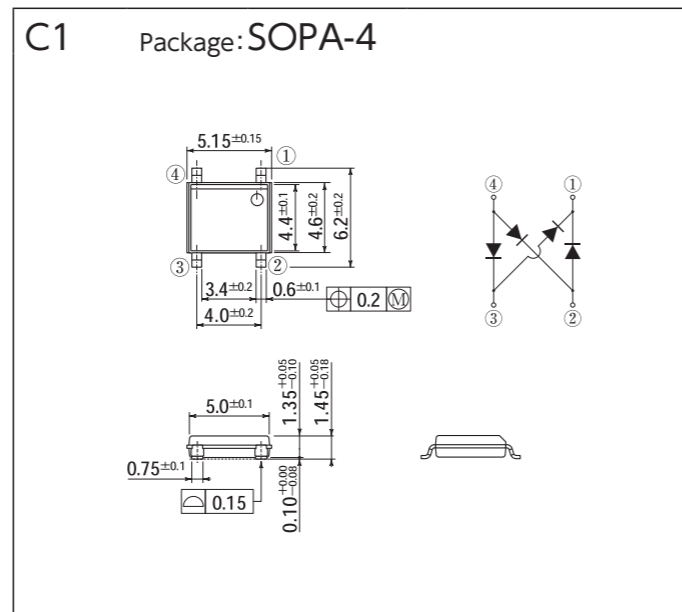
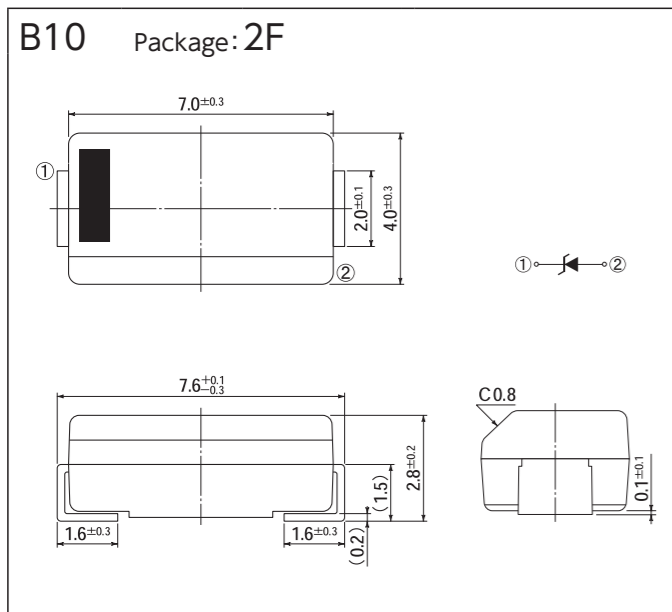
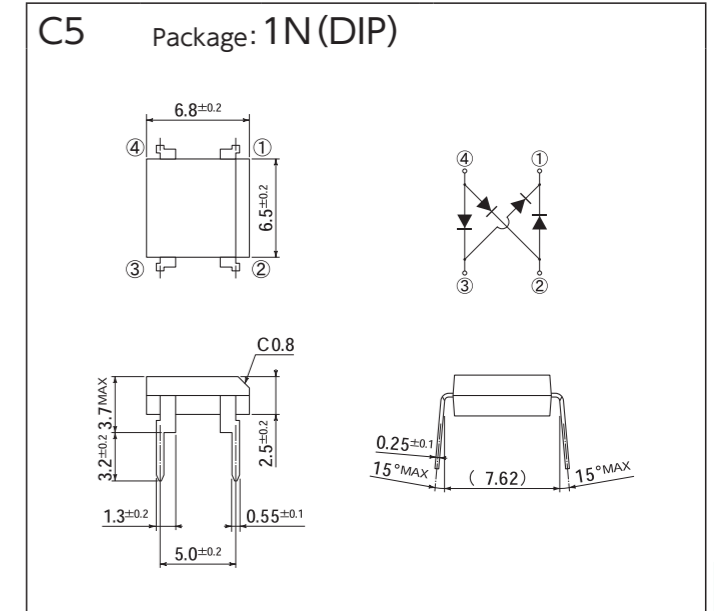
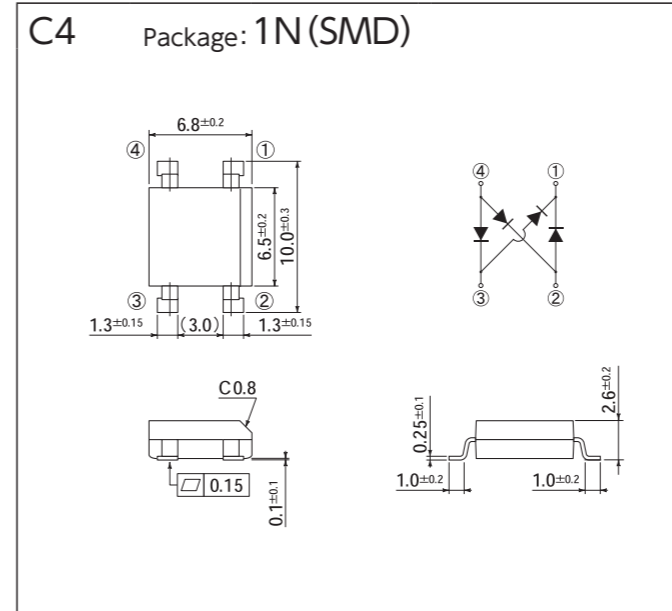
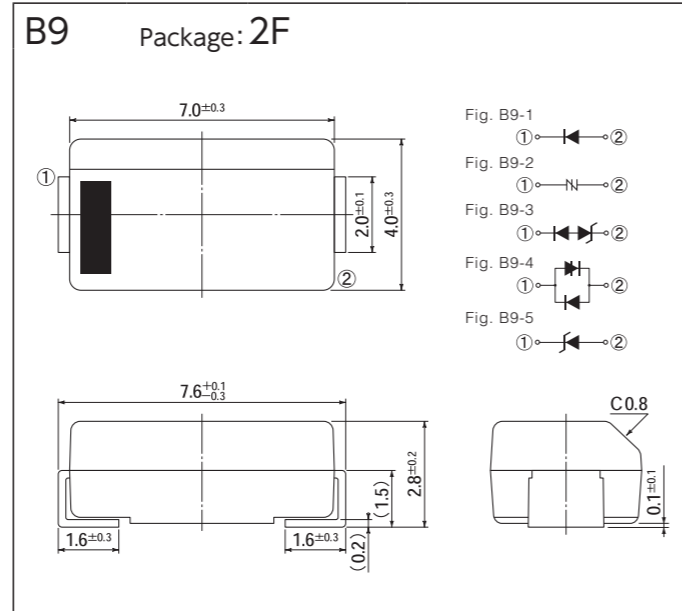
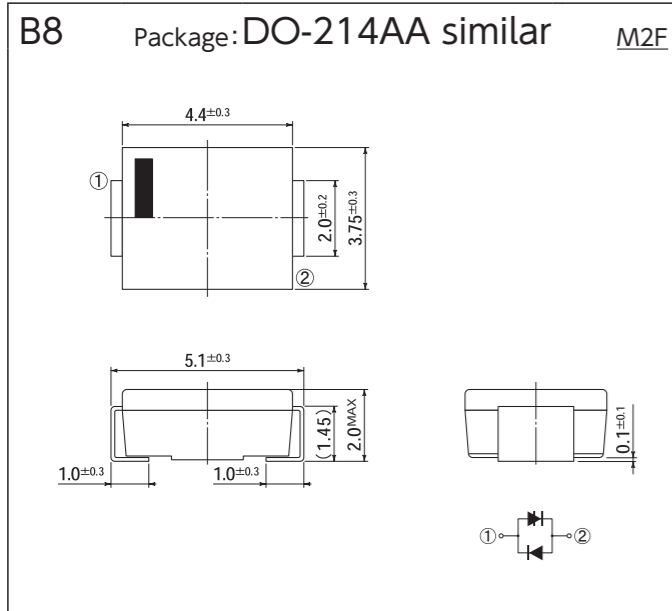
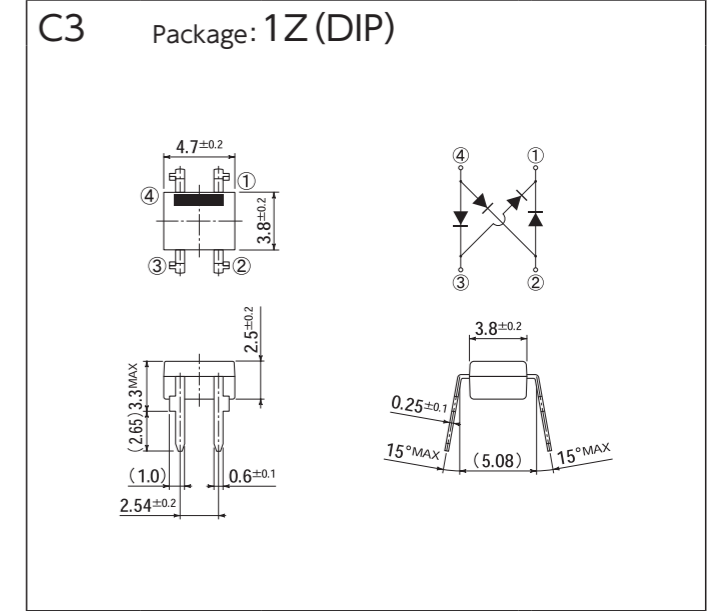

OUTLINE DIMENSIONS

OUTLINE DIMENSIONS

[Unit:mm]

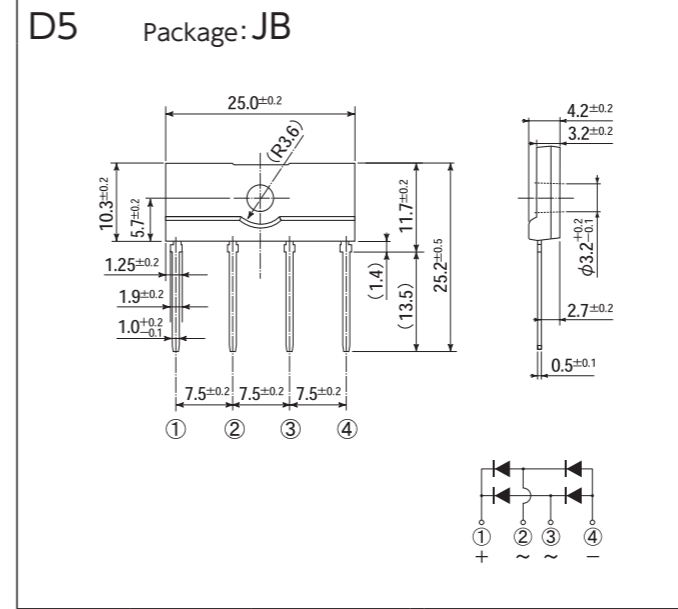
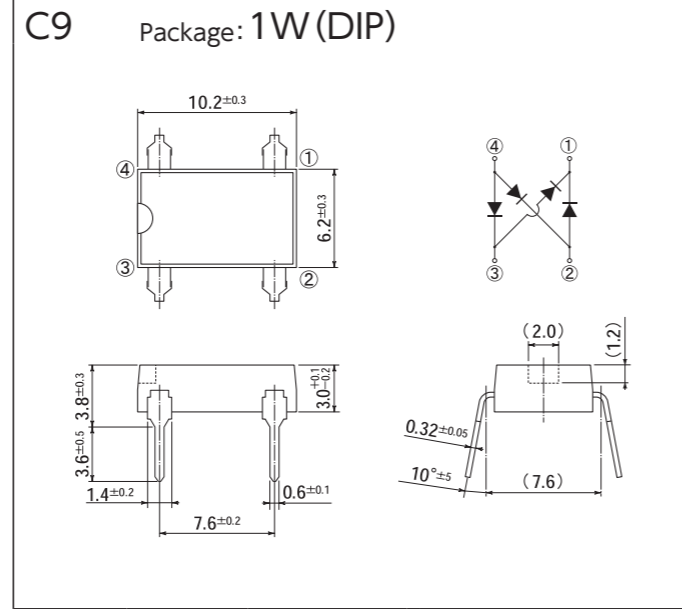
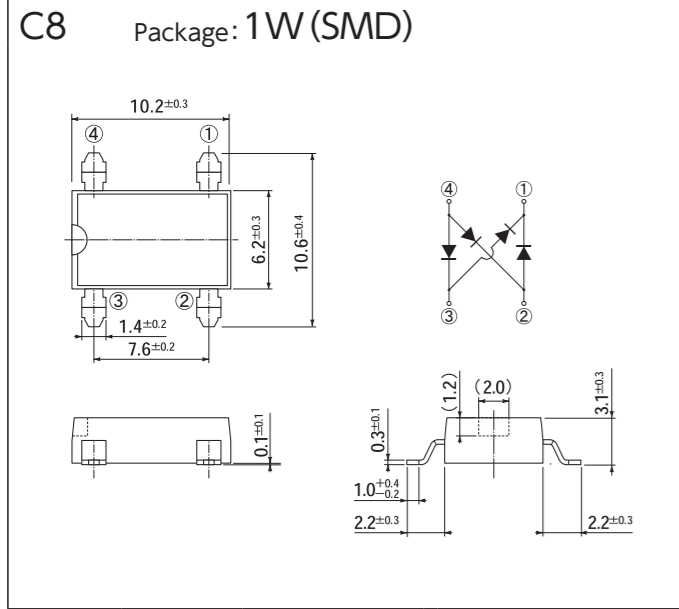

[Unit:mm]

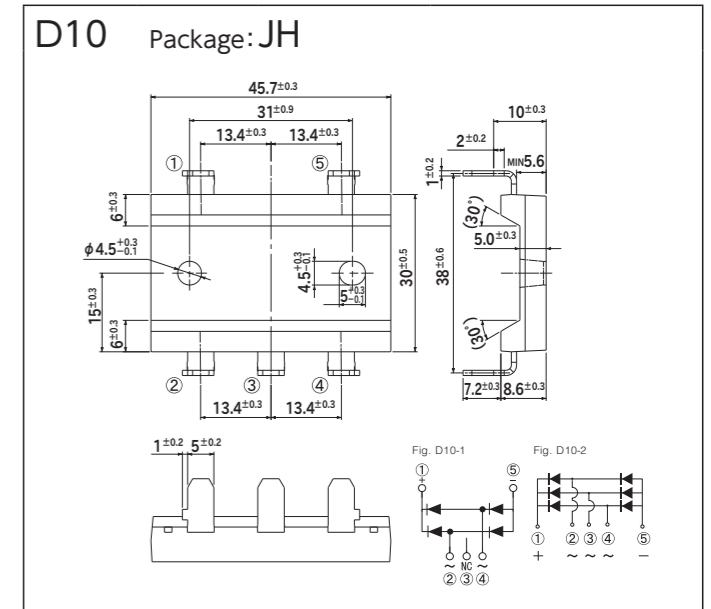
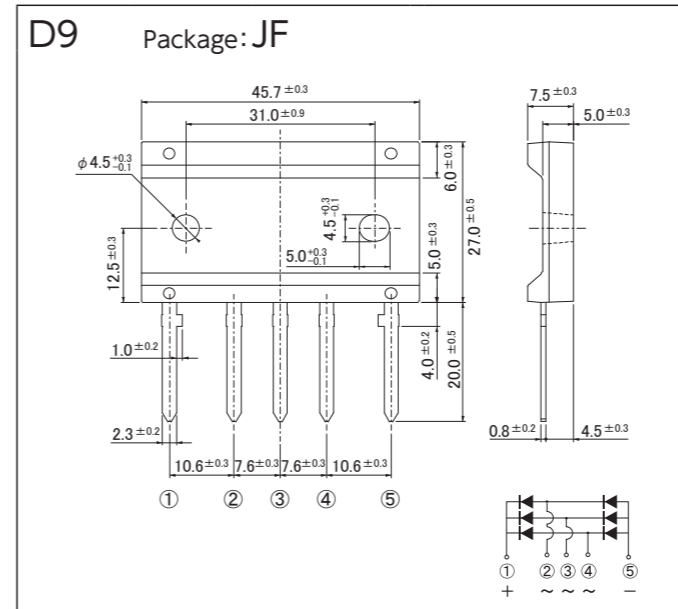
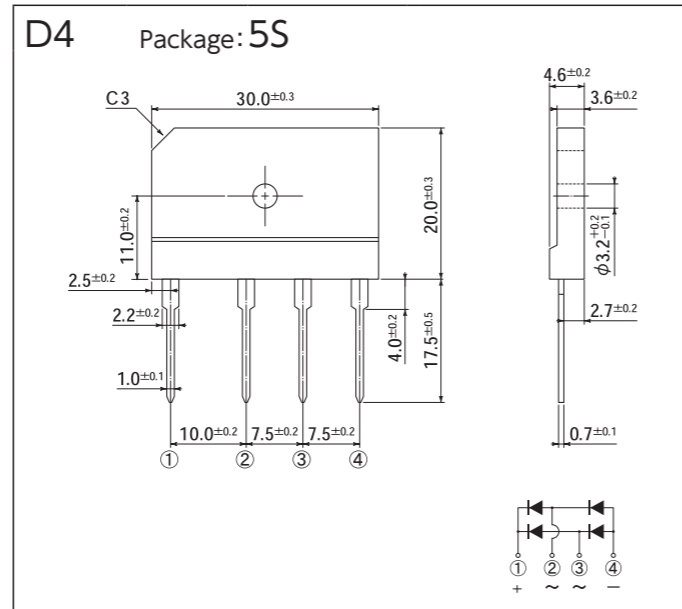
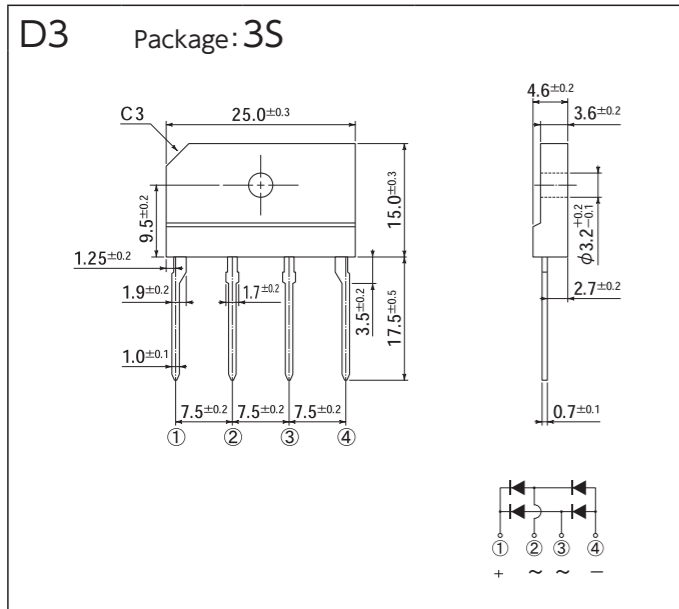
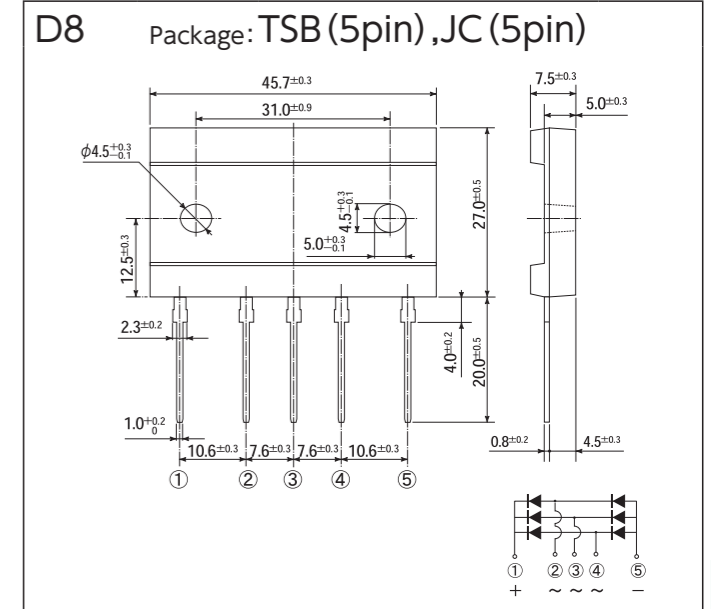
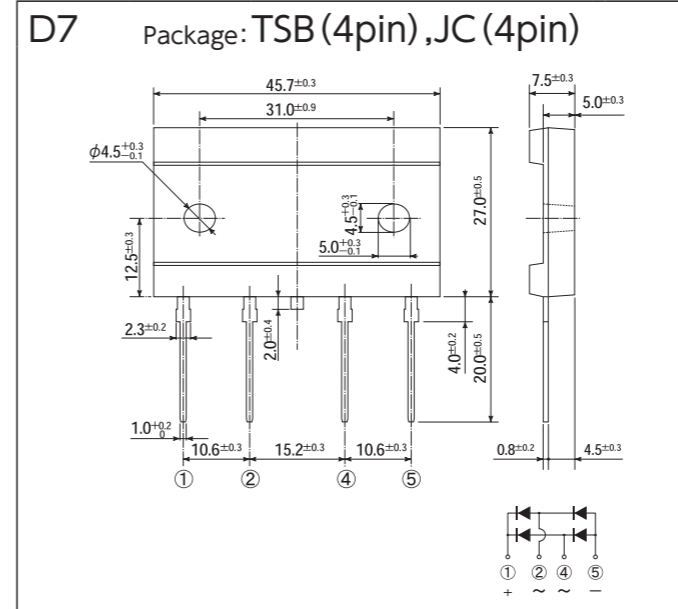
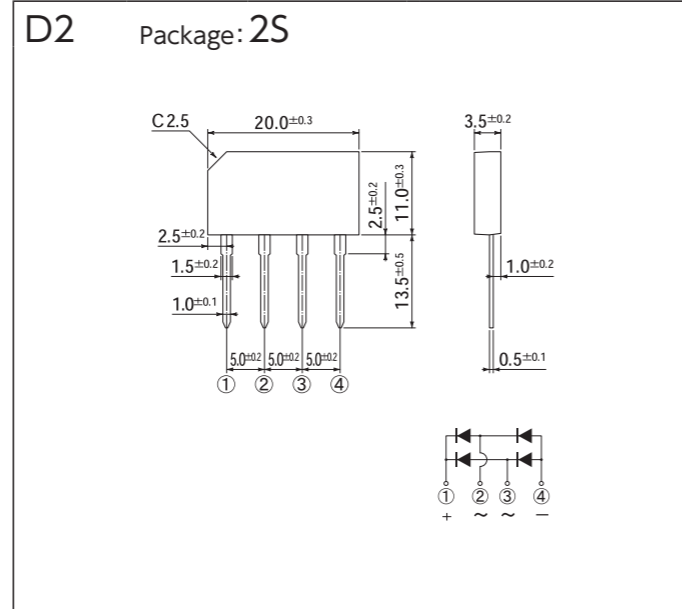
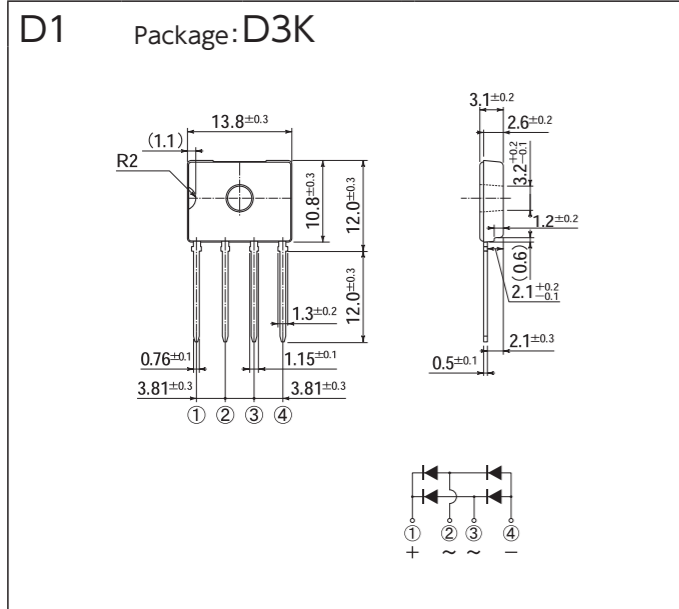
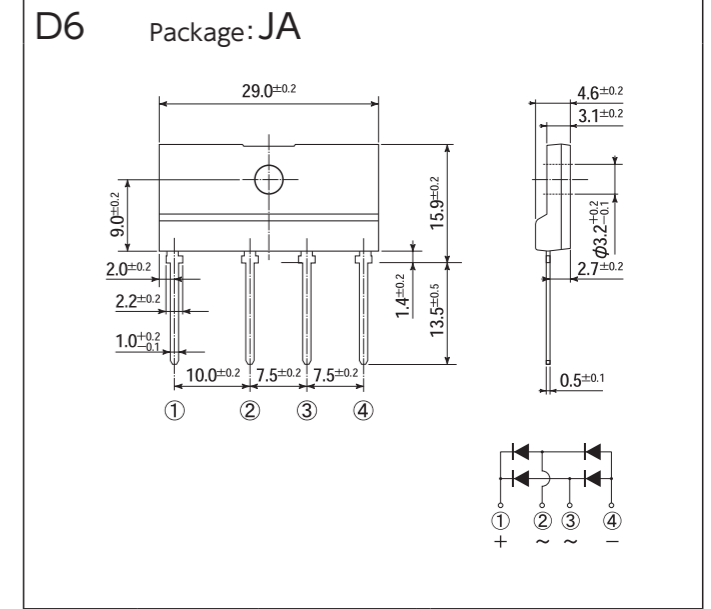

OUTLINE DIMENSIONS

OUTLINE DIMENSIONS

[Unit:mm]

E13 Package: S20WB

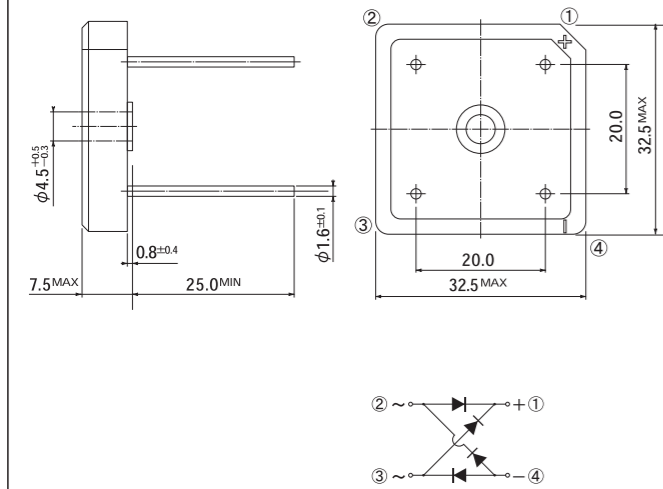

E14 Package: SVTA

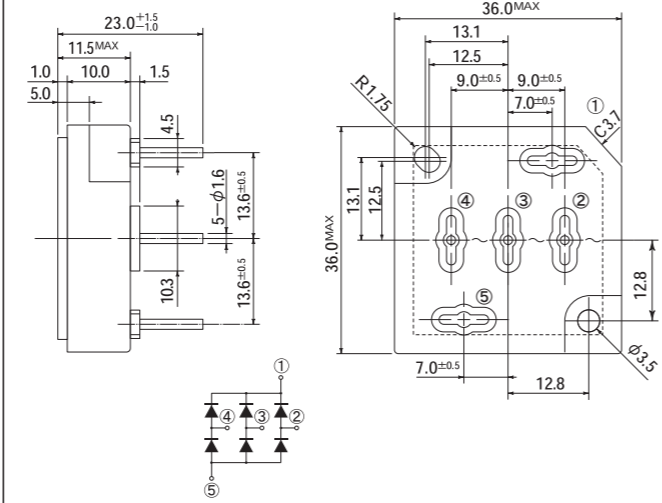

F4 Package: MG001

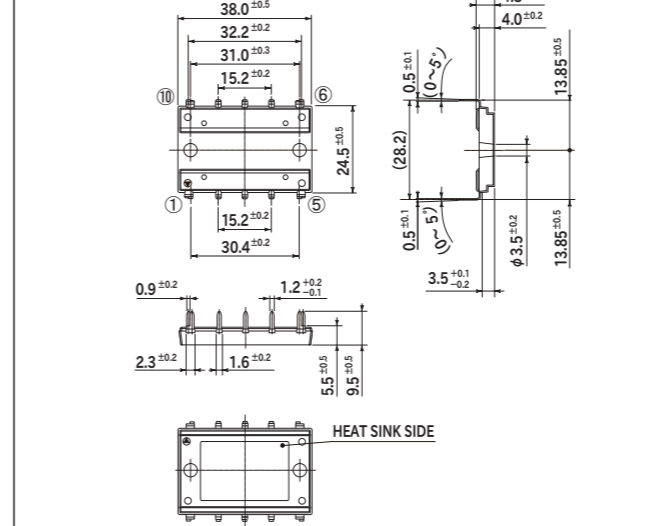

F5 Package: MG031

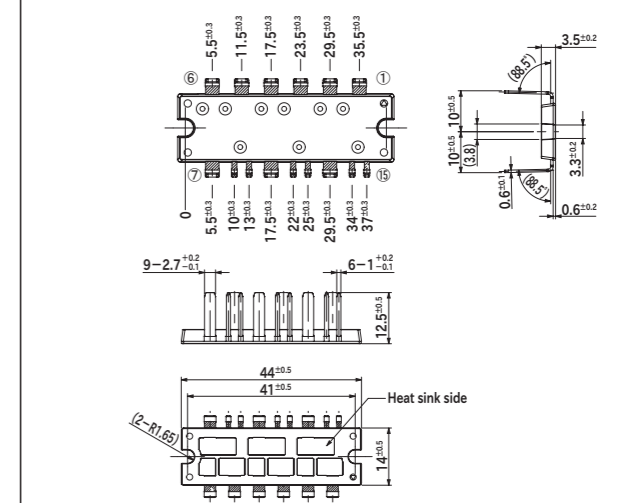

[Unit:mm]

E15 Package: SVT

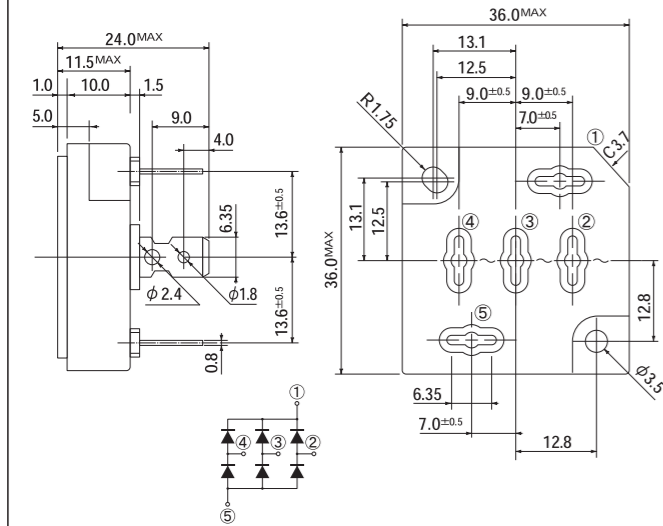

F1 Package: Module

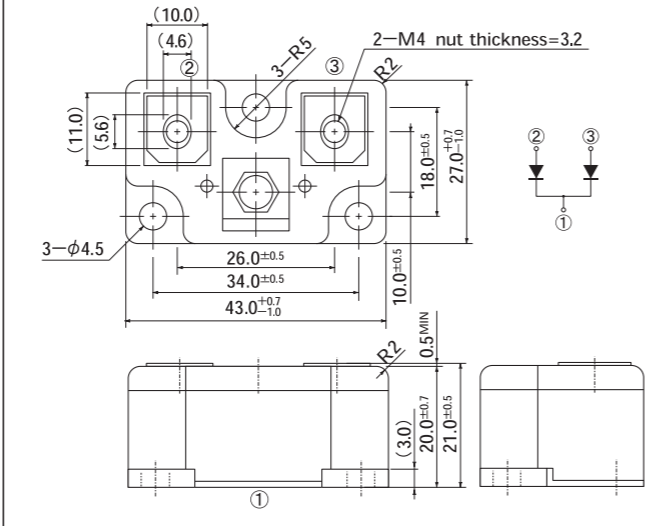

F6 Package: MG032

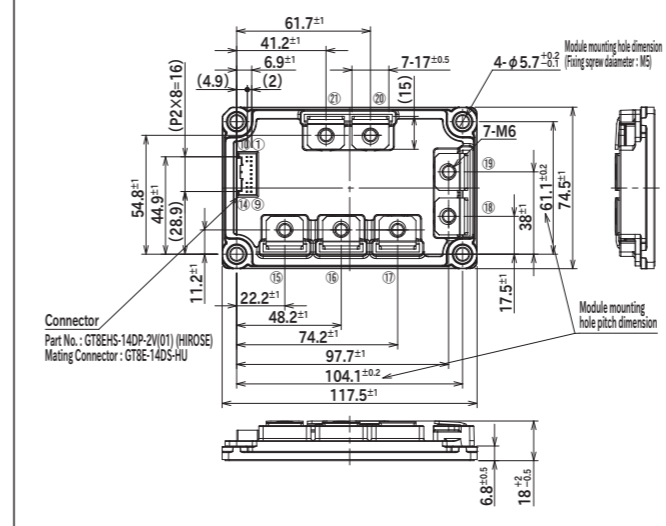

G1 Package: SC-63

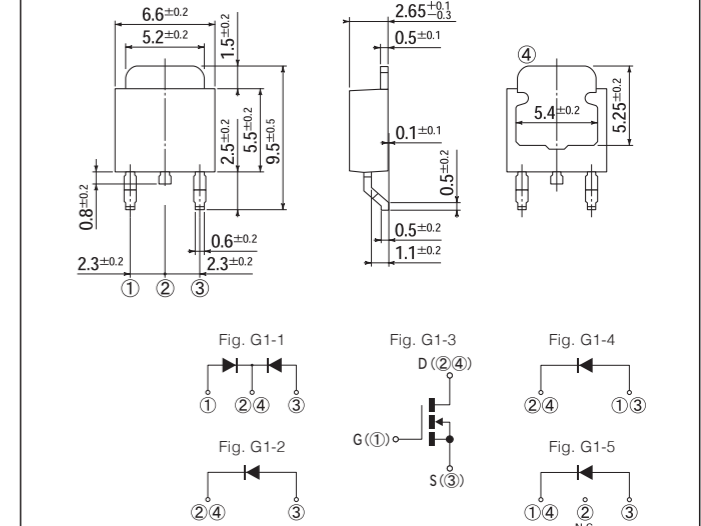

F2 Package: Module

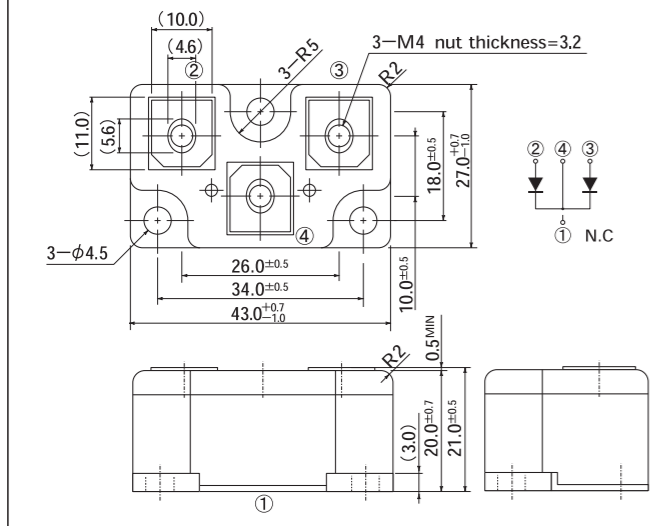

F3 Package: Module

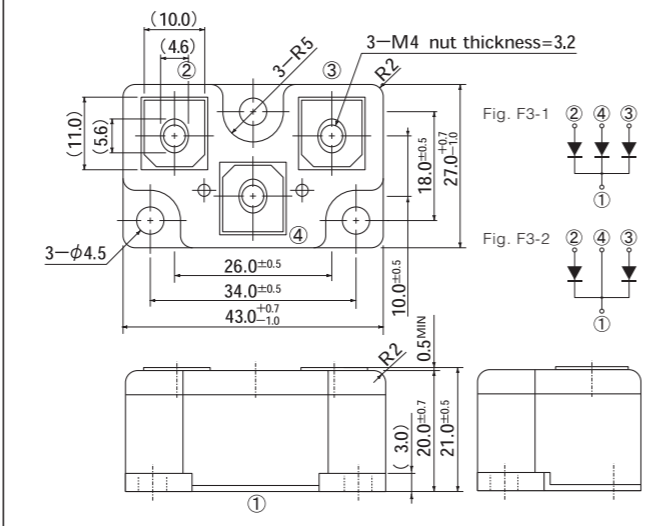

G2 Package: TO-252AA

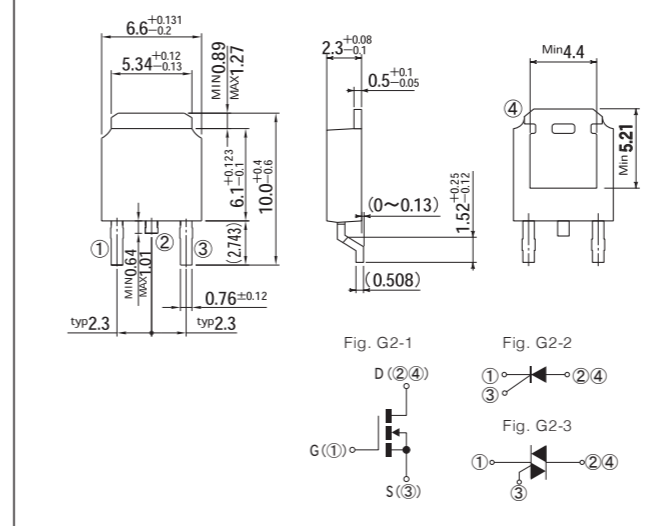

G3 Package: TO-252AB similar

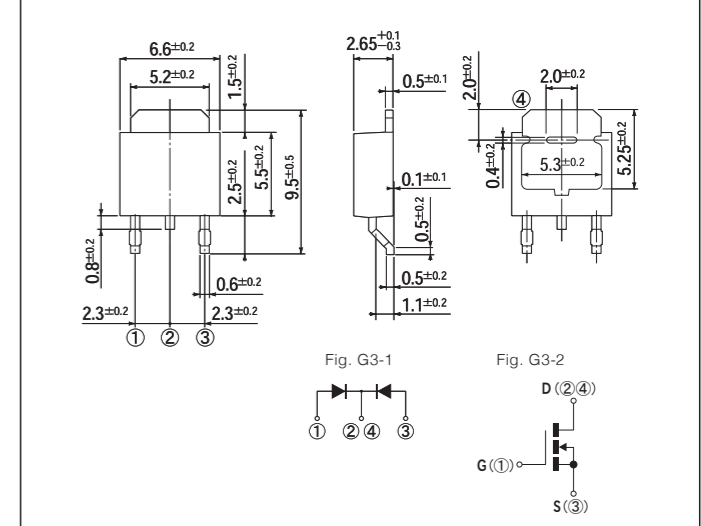

OUTLINE DIMENSIONS

[Unit:mm]

G4 Package: TO-277A similar FY

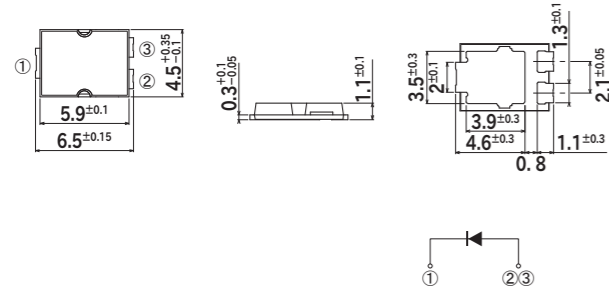

G5 Package: TO-252AA similar FR

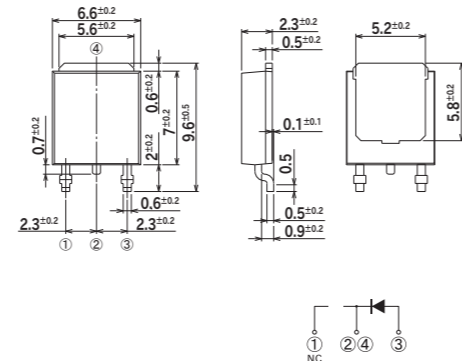

[Unit:mm]

H3 Package: TO-263AB-1 FH

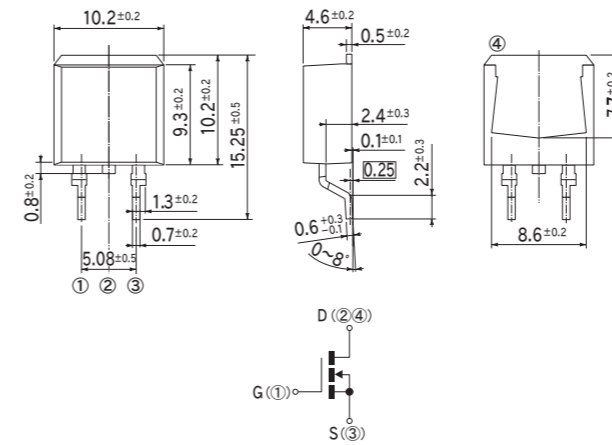

H4 Package: TO-263AB FG

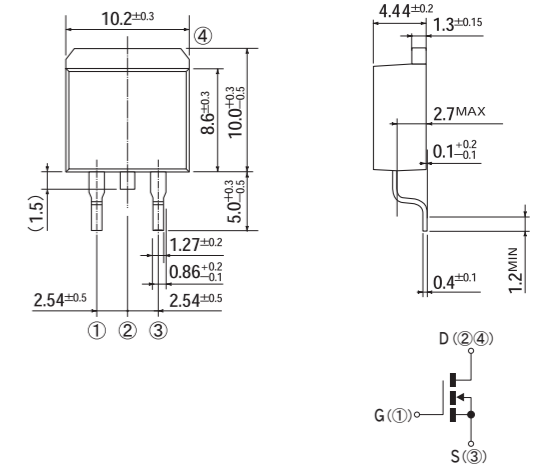

G6 Package: LA

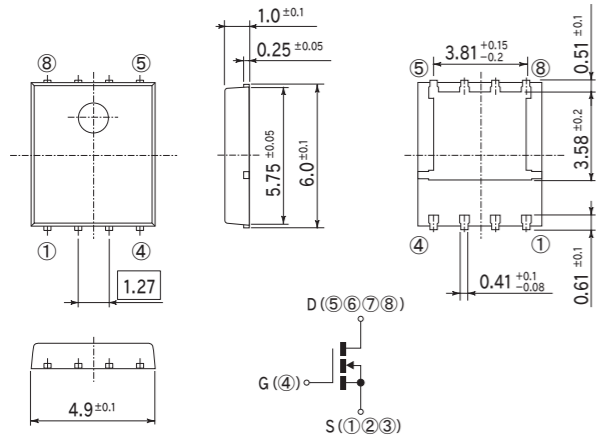

G7 Package: MO-235B similar LF

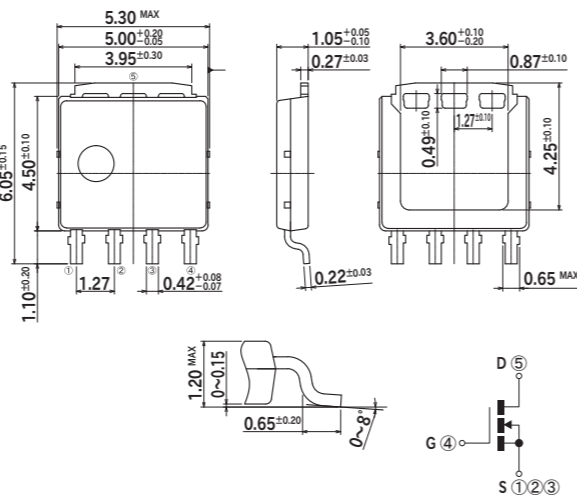

H5 Package: SC-83 similar FP

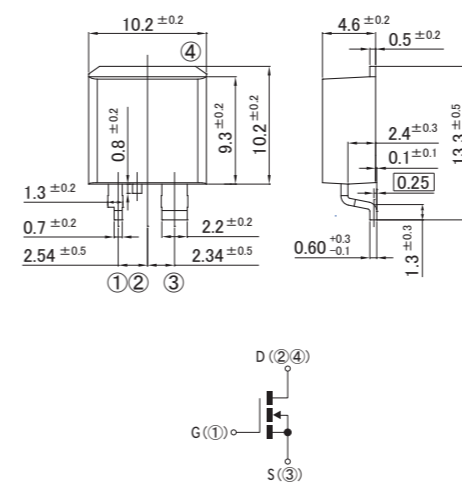

H6 Package: TO-263AB FZ

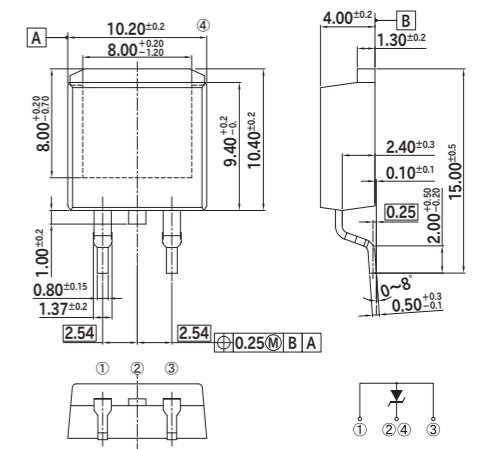

H1 Package: SC-83 similar STO-220

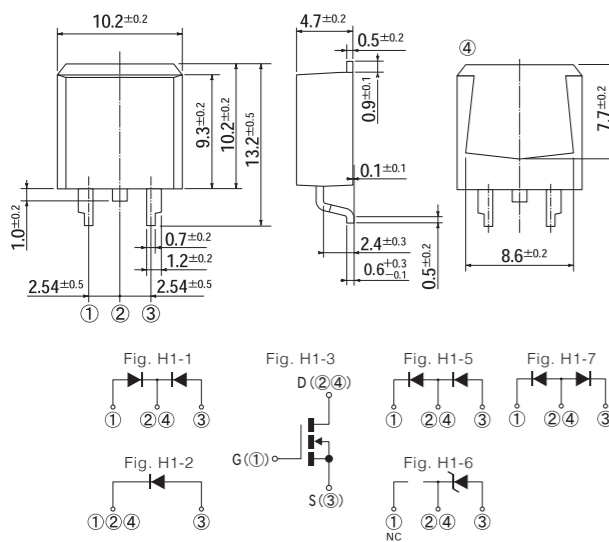

H2 Package: SC-83 similar FD

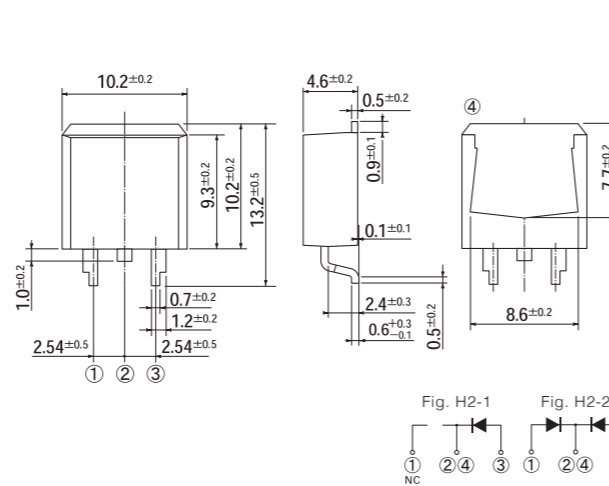

H7 Package: TO-263SC FZ-7p

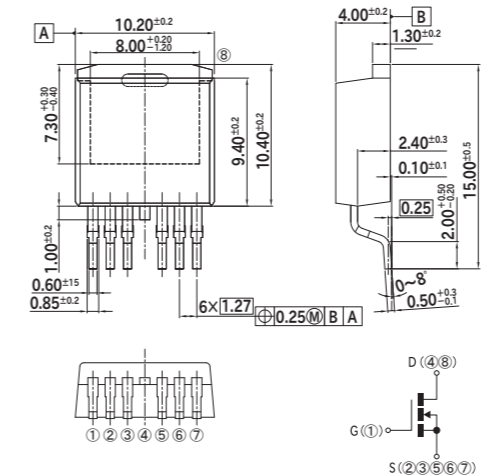

J1 Package: SC-91A FTO-220(2pin)

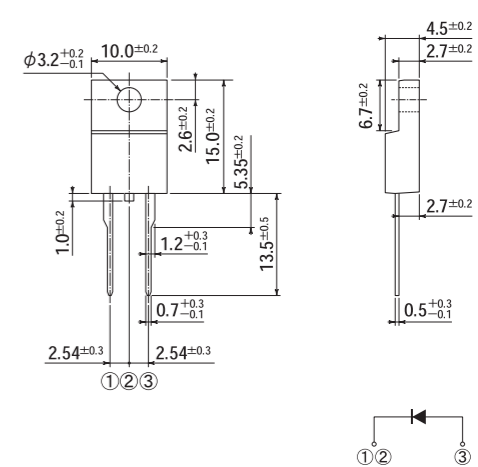

OUTLINE DIMENSIONS

[Unit:mm]

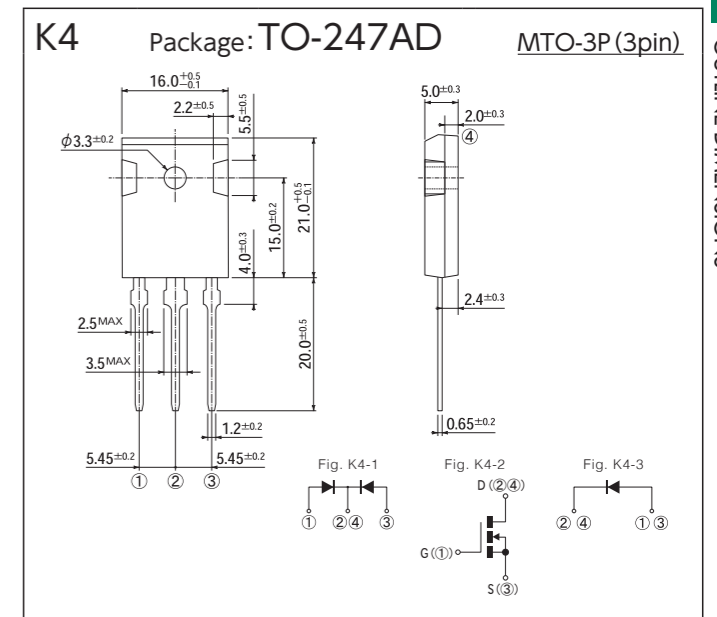
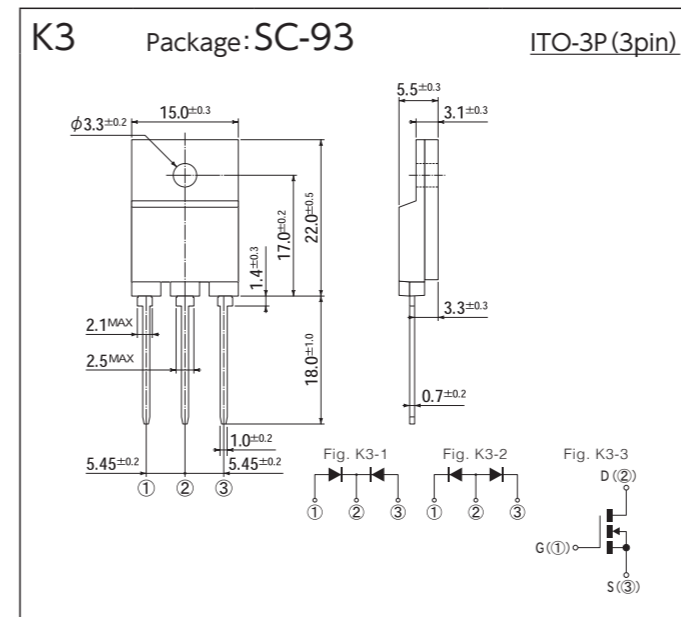
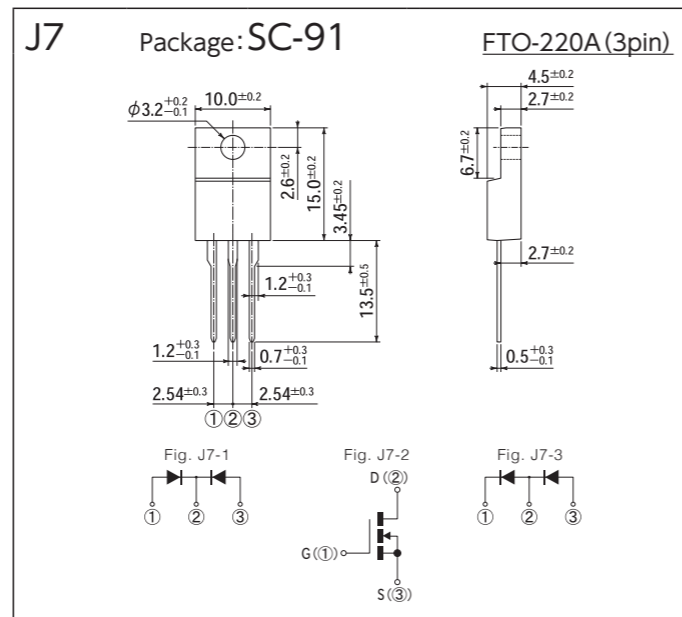
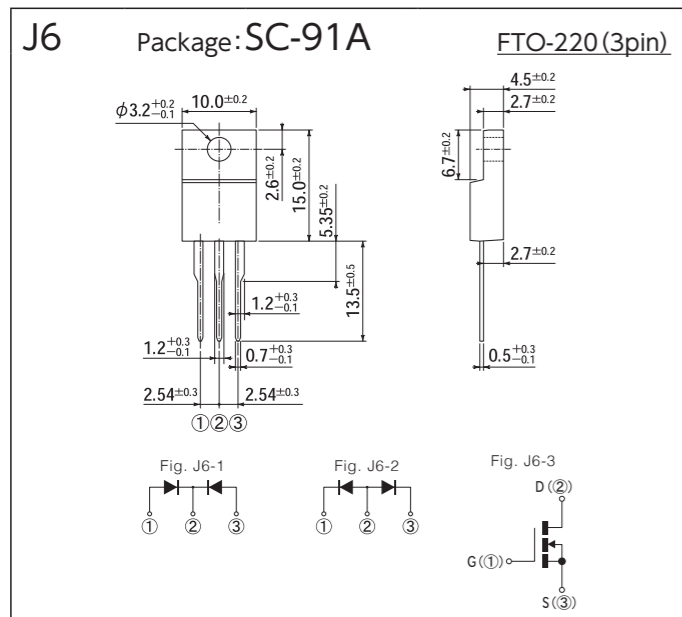
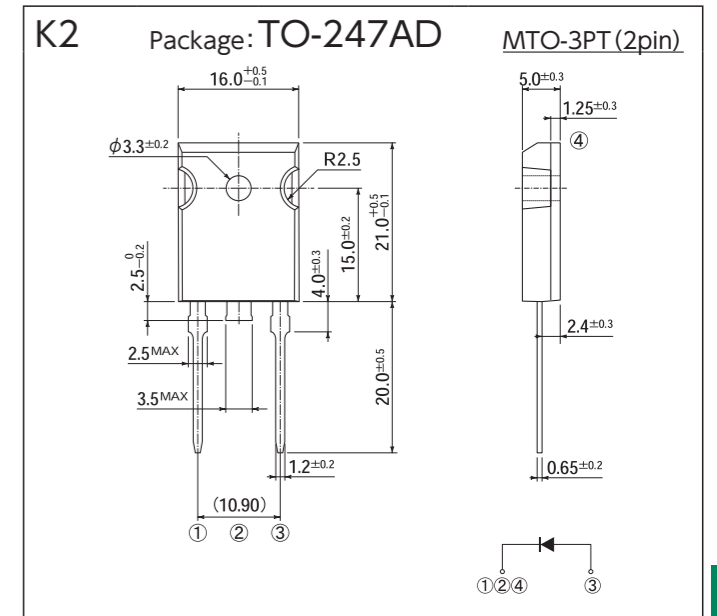
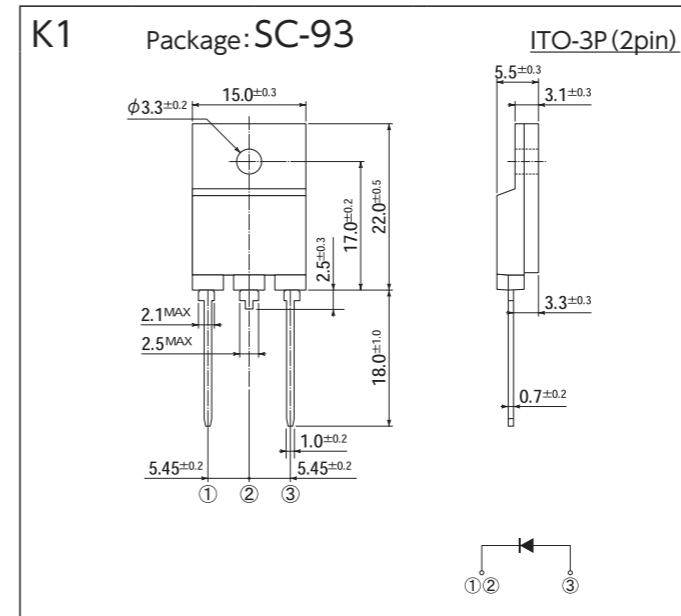
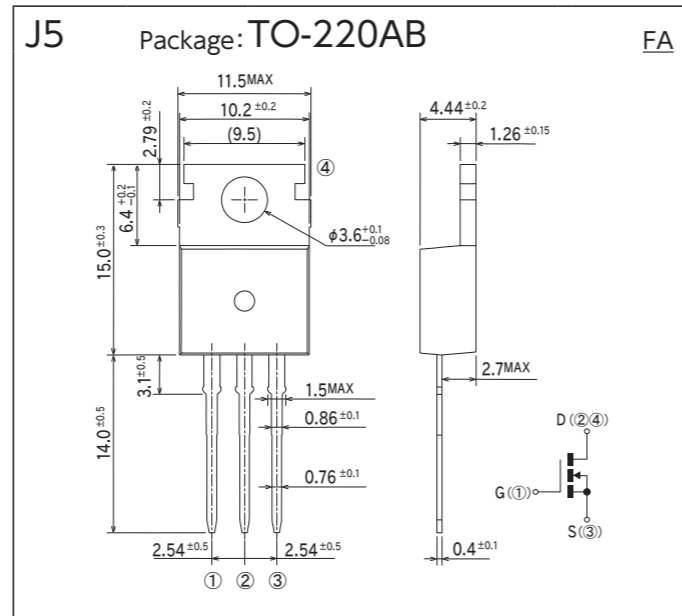
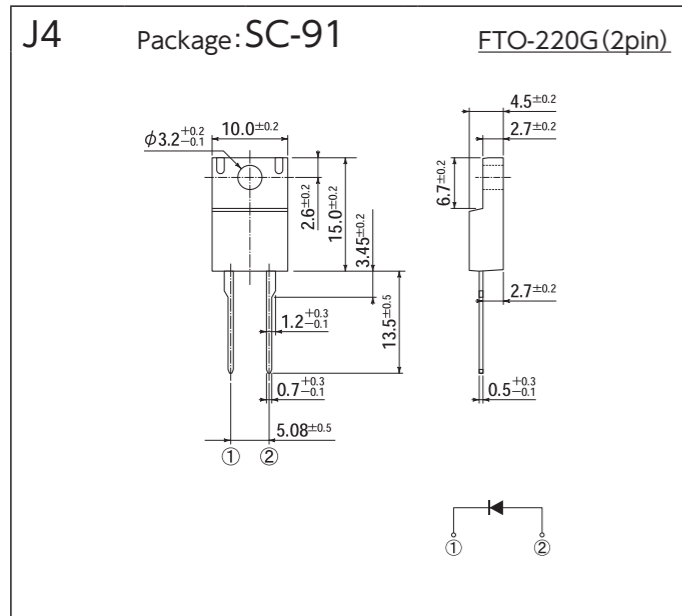
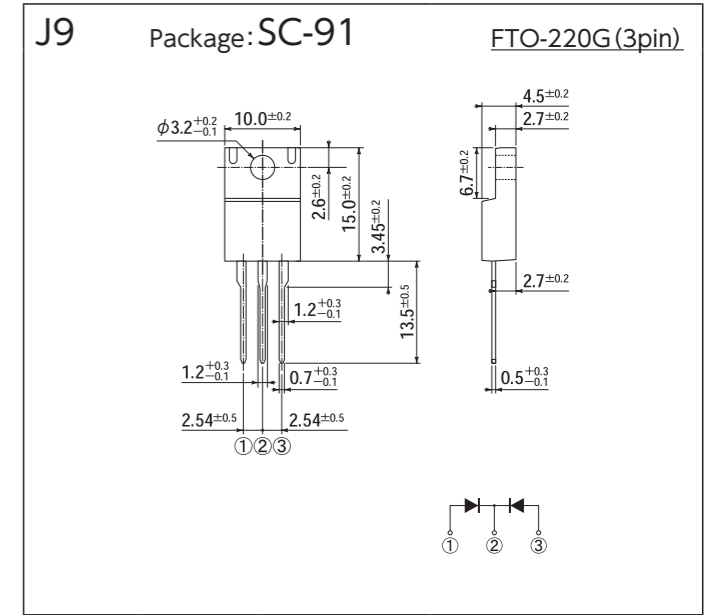
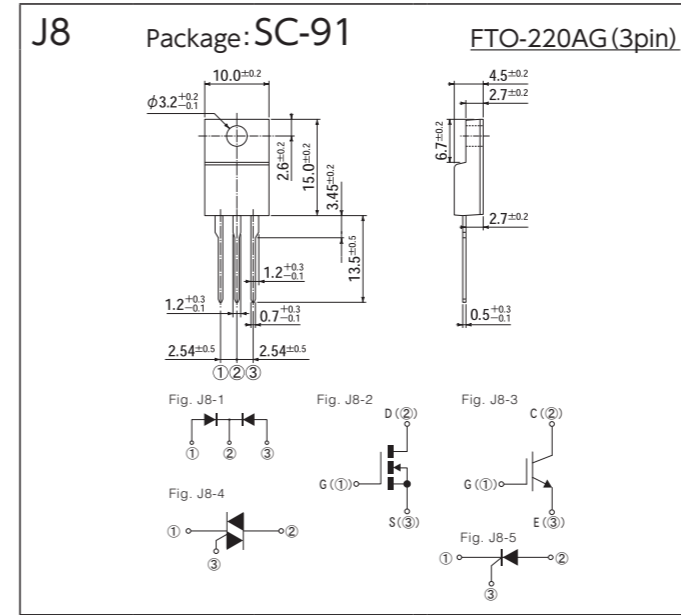
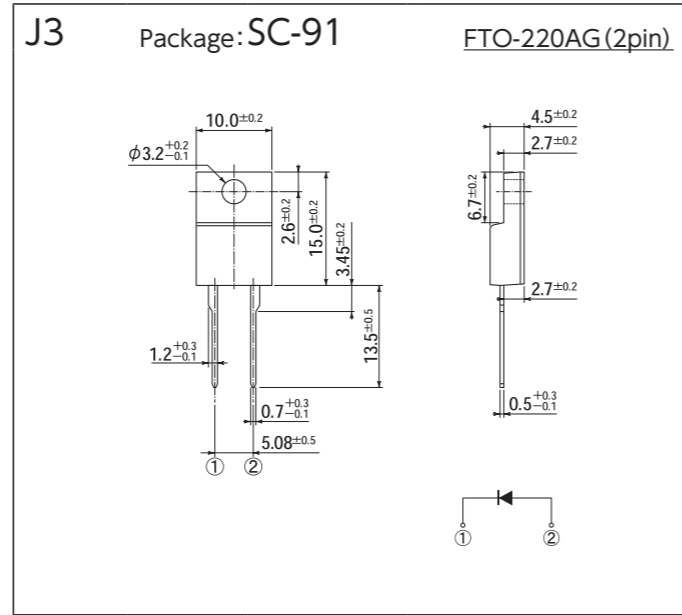
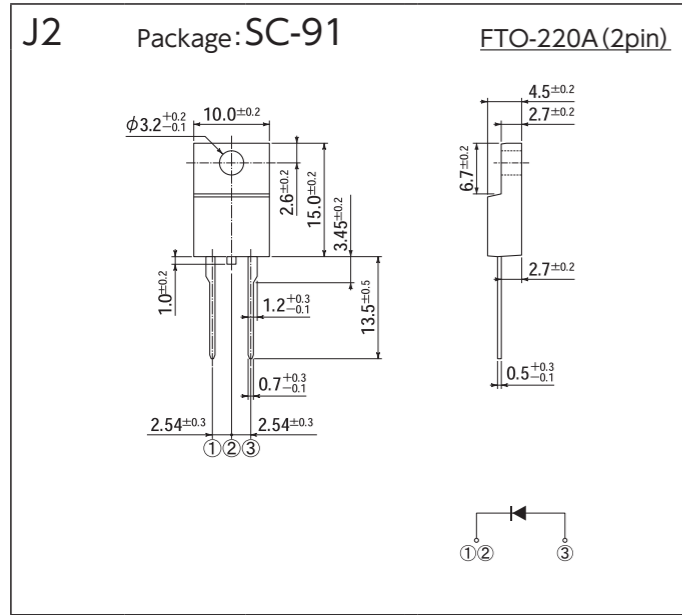

OUTLINE DIMENSIONS

[Unit:mm]

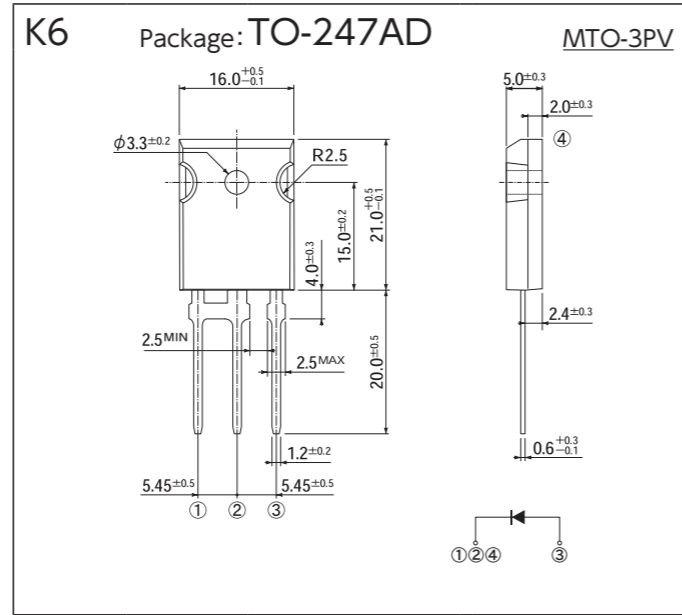
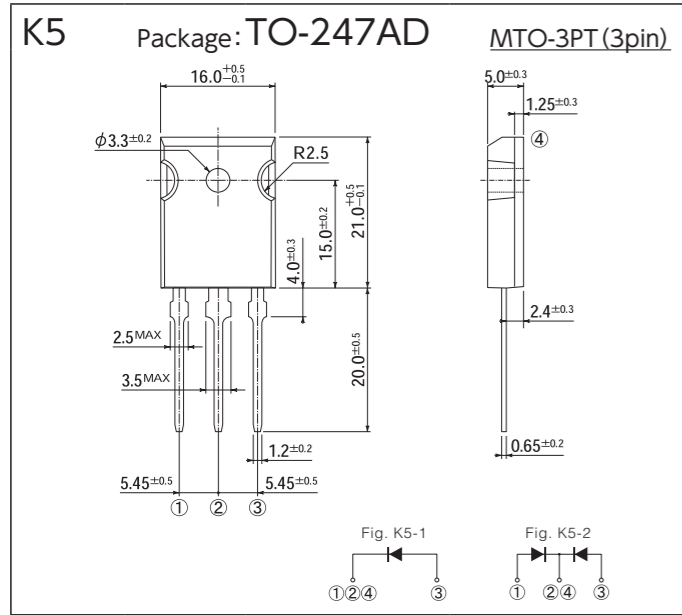

[Unit:mm]

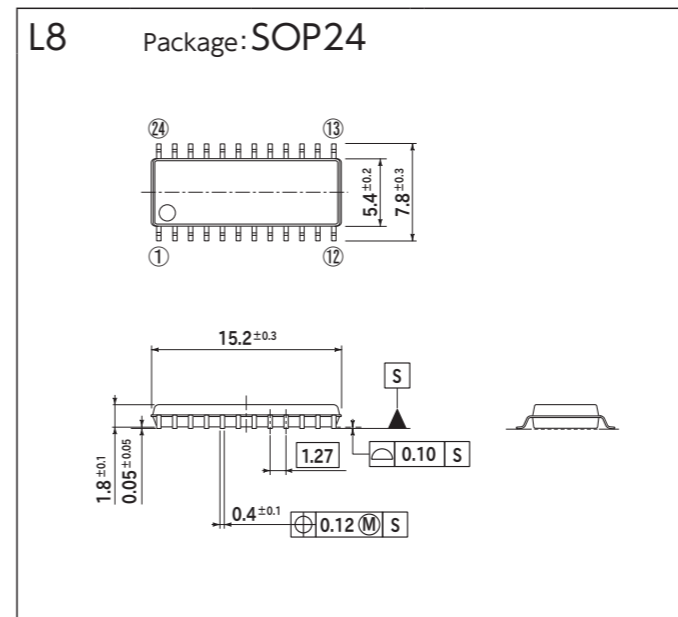
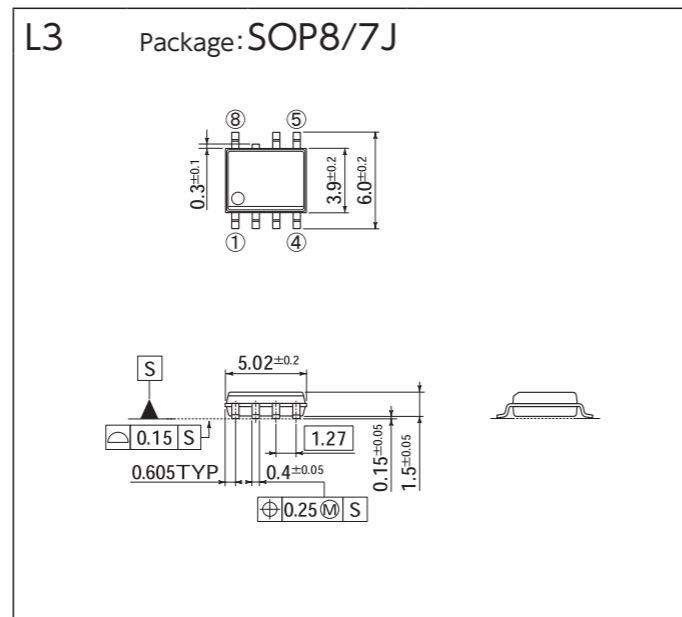
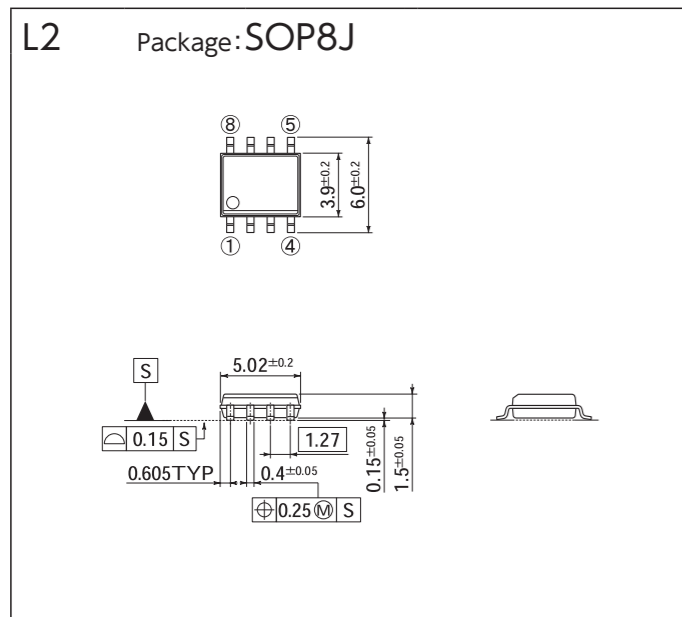
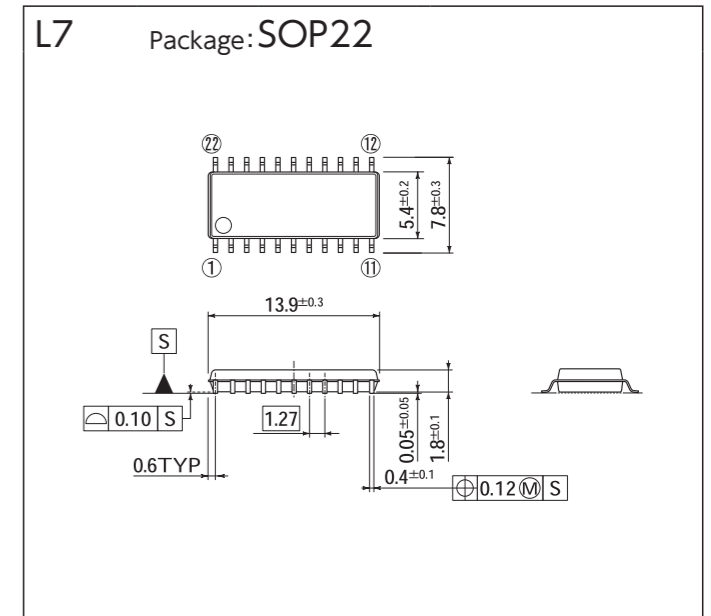
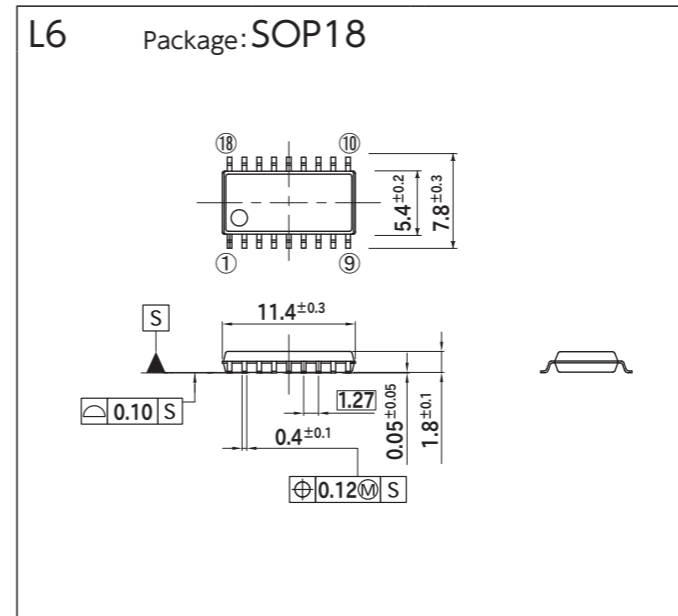
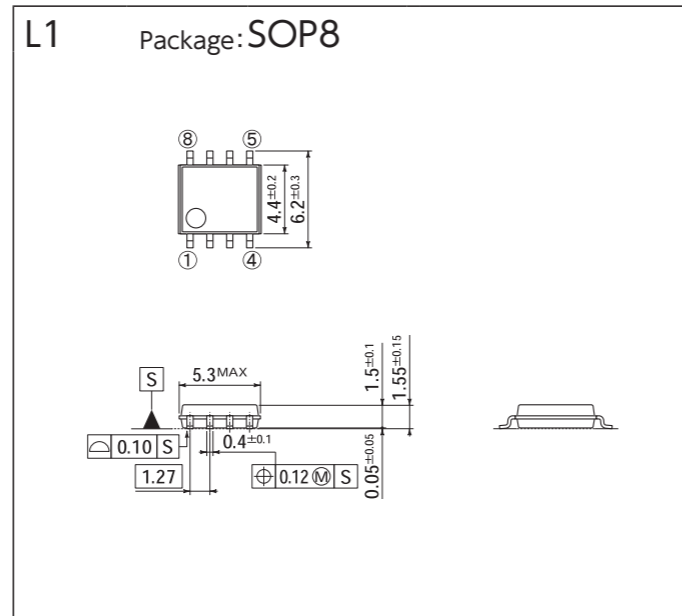
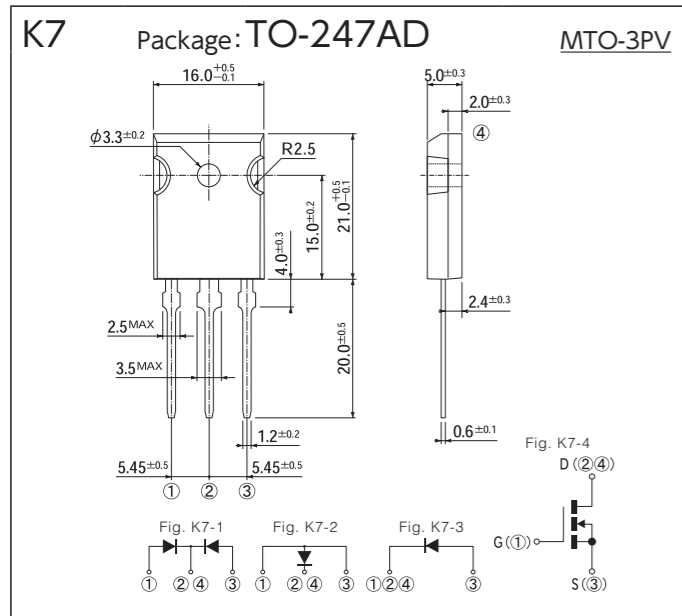
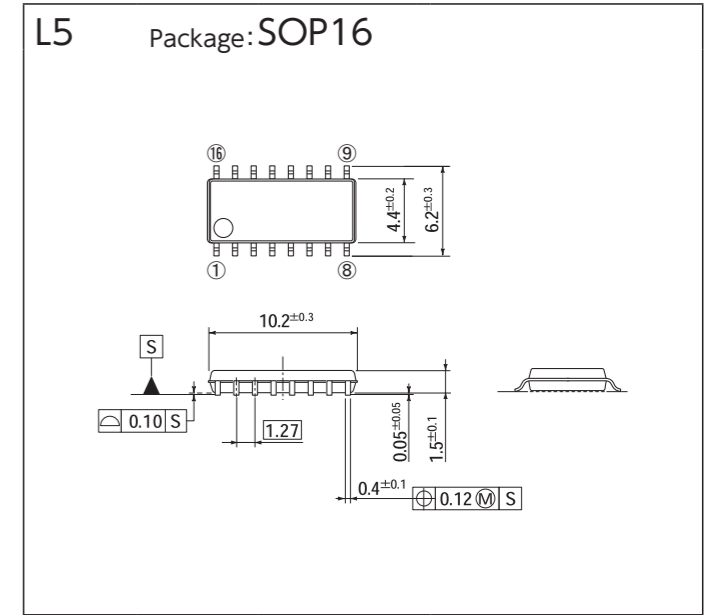
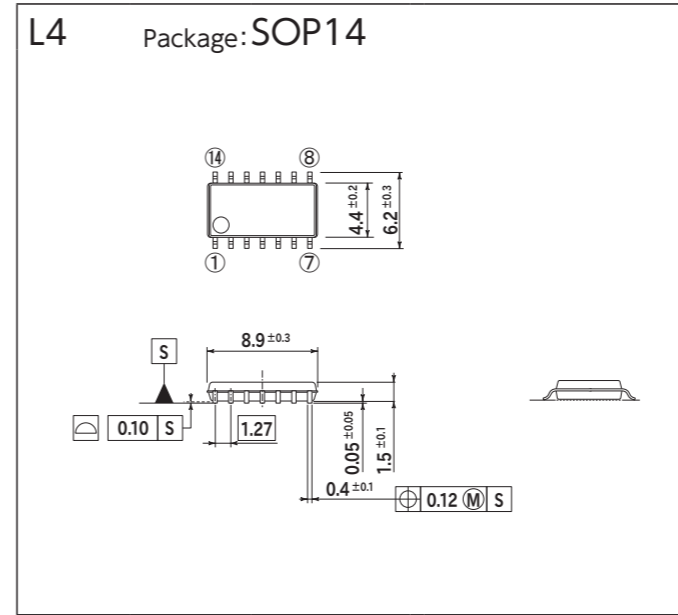

OUTLINE DIMENSIONS

PACKING SPECIFICATION

Please make your order: 'more than Inner Box Quantities' and 'a multiple of each Packing Unit'

Order Quantity & Packing Dimensions List

Please make your order: 'more than Inner Box Quantities' and 'a multiple of each Packing Unit'

Package			Fig.	Spec Code	Terminal Plating	MSL	Remarks	Quantity	Inner Box		Standard Packing		Packing Box (mm)			
JEDEC Package Code	JEITA Code	House Name							Method	Quantity (Pcs./Box)	Pcs./Box	Weight (kg)	L	W	H	
-	-	AX057	A1	-5060	Sn	-		4,000	Tape, Ammo-Pack 52mm	4,000	32,000	7.5	330	280	270	
				-5070		Standard		3,000	Tape, Ammo-Pack 26mm	3,000	36,000	6.2	340	275	230	
				-7000				200	Bulk	200	20,000	5.9	480	355	230	
		AX06	SIDAC	A2	Sn-Bi	-		4,000	Tape, Ammo-Pack 52mm	4,000	64,000	14.0	325	325	420	
				-7060				4,000	Tape&Reel, Diameter 300 φ 52mm	4,000	20,000	6.3	325	325	420	
				-7070				3,000	Tape, Ammo-Pack 26mm	3,000	72,000	15.7	325	325	420	
				-7000				200	Bulk	200	16,000	7.9	480	355	230	
				-7060	Sn-Bi	Standard		2,000	Tape, Ammo-Pack 52mm	2,000	32,000	14.7	325	325	420	
				-7070				1,500	Tape, Ammo-Pack 26mm	1,500	18,000	7.2	325	325	260	
				-5000				200	Bulk	200	16,000	7.9	480	355	230	
				-5060	Sn	Standard		2,000	Tape, Ammo-Pack 52mm	2,000	16,000	7.5	325	325	260	
				-5070				1,500	Tape, Ammo-Pack 26mm	1,500	18,000	7.2	325	325	260	
				-7000				200	Bulk	200	16,000	11.1	480	355	230	
				-7060	Sn-Bi	Standard		1,200	Tape, Ammo-Pack 52mm	1,200	18,000	14.4	325	325	420	
				-7061				2,500	Tape&Reel, Diameter 300 φ 52mm	2,500	12,500	10.8	325	325	420	
				-5000				200	Bulk	200	16,000	11.1	480	355	230	
				-5060	Sn	Standard		1,200	Tape, Ammo-Pack 52mm	1,200	9,600	7.3	325	325	260	
				-5061				2,500	Tape&Reel, Diameter 300 φ 52mm	2,500	12,500	10.8	325	325	420	
				-5000				200	Bulk	200	16,000	17.5	480	355	230	
				-5060	Sn			1,200	Tape, Ammo-Pack 52mm	1,200	9,600	11.2	325	325	260	
				-5061				2,500	Tape&Reel, Diameter 300 φ 52mm	2,500	10,000	13.0	350	355	350	
DO-219AB similar	SC-109	G1F	SMD	B1	-5063R	Sn	1	4,000	Tape&Reel, Diameter 180 φ	24,000	48,000	1.6	180	205	210	
DO-219AA similar	-	M1F	SMD	B2	-6063	Sn	1	2,500	Tape&Reel, Diameter 180 φ	15,000	75,000	4.5	405	210	220	
								100	Magazine	100	15,000	2.3	545	145	110	
DO-214AC	-	1F	SMD	B3 B4	-5053	Sn	1	Standard	2,000	Tape&Reel, Diameter 180 φ	8,000	40,000	4.1	340	195	205
					-5073			7,500	Tape&Reel, Diameter 330 φ	45,000	90,000	10.8	395	245	395	
								3,000	Tape&Reel, Diameter 180 φ	12,000	24,000	1.6	180	205	210	
DO-214AA similar	SC-110B	CE	SMD	B5 B6 B7 B8	-5063	Sn	1	Standard	1,000	Tape&Reel, Diameter 180 φ	4,000	20,000	3.4	340	195	205
					-5073			4,000	Tape&Reel, Diameter 330 φ	4,000	48,000	8.6	395	245	395	
								60	Magazine	60	18,000	5.2	545	145	110	
					-5063	Sn	1	Standard	750	Tape&Reel, Diameter 180 φ	3,000	15,000	4.2	340	195	205
					-5073			3,000	Tape&Reel, Diameter 330 φ	3,000	36,000	9.2	395	245	395	
								1,000	Tape&Reel, Diameter 180 φ	1,000	20,000	3.6	340	195	205	
								1,000	Tape&Reel, Diameter 180 φ	1,000	20,000	3.6	340	195	205	
TO-269AA	-	1Z	SMD	C2	-7102	Sn-Bi	1		100	Magazine	100	15,000	3.2	545	145	110
					-7062			S1ZA type	750	Tape&Reel, Diameter 180 φ	3,000	15,000	4.0	340	195	205
					-7062			S1ZB type	750	Tape&Reel, Diameter 180 φ	3,000	15,000	4.0	405	210	220
					-7072				3,000	Tape&Reel, Diameter 330 φ	3,000	15,000	4.6	340	340	120
					-7101			S1ZB type	100	Magazine	100	10,000	2.1	545	145	110
									70	Magazine	70	5,600	4.1	545	145	100
					-7062	Sn-Bi	1		1,000	Tape&Reel, Diameter 250 φ	1,000	10,000	5.5	275	285	295
									70	Magazine	70	5,600	4.1	545	145	100
									70	Magazine	70	5,600	4.1	545	145	100
					-7102	Sn-Bi	1		50	Magazine	50	4,000	4.4	545	145	110
					-7062				1,000	Tape&Reel, Diameter 330 φ	3,000	6,000	5.5	395	245	395
					-7072				2,000	Tape&Reel, Diameter 380 φ	2,000	10,000	7.8	395	245	395
									50	Magazine	50	4,000	4.4	545	145	110
					-7101	Sn-Bi	-		50	Magazine	50	4,000	4.4	545	145	110
					-7000	Sn-Bi	-		500	Bulk	500	2,500	4.0	210	188	200
					-7000	Sn-Bi	-		100	Bulk	500	6,000	14.4	410	380	170
					-7000	Sn-Bi	-		50	Bulk	250	2,000	9.5	310	285	196
					-7000	Sn-Bi	-		50	Bulk	250	2,000	14.5	330	330	215
					-7000	Sn-Bi	-		250	Bulk	250	2,000	7.4	287	301	169
					-7000	Sn-Bi	-		250	Bulk	250	2,000	9.0	327	329	185
									100	Bulk	100	400	9.8	351	269	164
									40	Tray	40	200	5.6	503	356	135
									40	Tray	40	200	5.6	503	356	135
									40	Tray	40	200	5.6	503	356	135
									300	Tape&Reel, Diameter 255 φ	300	1,500	5.0	280	275	190
									600	Tape&Reel, Diameter 330 φ	600	1,800	5.5	335	345	110

Exterior packaging is an example. Depending on the quantity ordered, the number of incoming, outline and weight may change.

Package		Fig.	Spec Code	Terminal Plating	MSL	Remarks	Quantity	Inner Box		Standard Packing		Packing Box (mm)			
JEDEC Package Code	JEITA Code							House Name	Method	Quantity (Pcs./Box)	Pcs./Box	Weight (kg)	L	W	H
-	-	D30VC	THD	E2	-4000	Ag	-	100	Tray	100	500	7.0	375	285	160
-	-	S2VB	THD	E3	-5000	Sn-Ag-Cu	-	100	Tray	100	1,000	3.6	265	255	170
-	-	S4VB	THD	E4	-5000	Sn-Ag-Cu	-	100	Tray	100	1,000	5.9	315	285	220
-	-	S5VB	THD	E5	-5000	Sn-Ag-Cu	-	100	Tray	100	1,000	10.4	415	285	300
-	-	S10VB	THD	E6	-5000	Sn-Ag-Cu	-	100	Tray	100	1,000	9.3	375	285	270
-	-	S15VB	THD	E7	-4000	Ag	-	100	Tray	100	500	9.0	415	285	180
-	-	S25VB	THD	E8	-4000	Ag	-	60	Bulk	60	300	7.0	335	205	165
-	-	S50VB	THD	E9	-4000	Ag	-	50	Tray	50	200	6.2	335	205	165
-	-	S3WB	THD	E10	-5000	Sn-Ag-Cu	-	100	Tray	100	1,000	6.1	315	285	220
-	-	S10WB	THD	E11	-5000	Sn-Ag-Cu	-	100	Tray	100	1,000	9.3	375	285	270
-	-	S15WB	THD	E12	-5000	Sn-Ag-Cu	-	100	Tray	100	1,000	15.1	415	285	300
-	-	S20WB	THD	E13	-5000	Sn-Ag-Cu	-	100	Tray	100	700	15.0	415	285	300
-	-	SVTA	THD	E14	-5000	Sn-Ag-Cu	-	50	Tray	50	250	8.7	460	295	240
-	-	SVT	THD	E15	-4000	Ag	-	45	Bulk	200	200	13.6	335	205	165
-	-	MODULE	-	F1 F2 F3	-4000	Ni	-	25	Tray	100	200	13.4	480	330	210
-	-	MG001	THD	F4	-7101	Sn-Bi	-	15	Magazine	15	450	7.1	623	232	144
-	-	MG031	THD	F5	-7101	Sn-Bi	-	12	Magazine	12	600	8.5	573	281	127
-	-	MG032	THD	F6	-4500	Ni	-	24	Tray	24	24	8.0	610	315	140
								80	Magazine	80	10,000	6.9	560	130	109
								1,500	Tape&Reel, Diameter 250 φ	1,500	6,000	2.9	260	260	99
								3,000	Tape&Reel, Diameter 330 φ	3,000	12,000	5.5	335	335	99
								80	Magazine	80	10,000	6.9	560	130	109
								1,500	Tape&Reel, Diameter 250 φ	1,500	6,000	2.9	260	260	99
								3,000	Tape&Reel, Diameter 330 φ	3,000	12,000	5.5	335	335	99
TO-252AA	-	FB	SMD	G2	-5071	Sn	1								

Memo

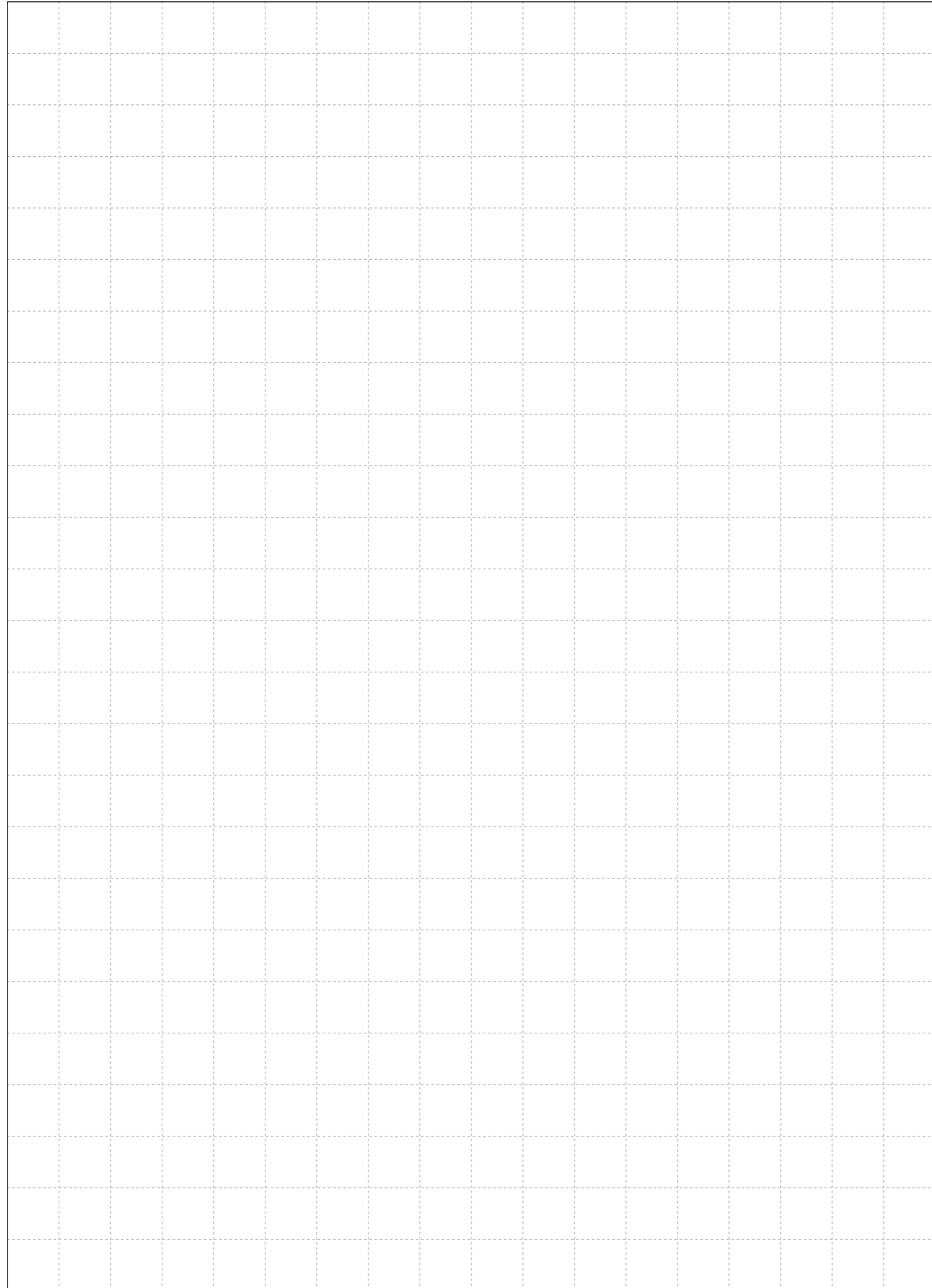

Memo

