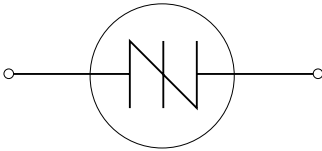


Kxxx0yH Series

RoHS



Schematic Symbol



Description

The new Kxxx0yH is a higher energy SIDAC switch for gas ignition applications requiring higher current pulse current especially at low repetition rate. It is offered in a DO-15 and TO-92 leaded packages as well as DO-214 surface mount package. Voltage activation of this solid state switch is accomplished with peak voltage level of 190 to 280Volts. The SIDAC is a silicon bilateral voltage triggered Thyristor switch that switches on through a negative resistance region to a low on-state voltage. Conduction will continue until current is interrupted or lowered below minimum holding current of the device.

Features

- AC Circuit Oriented
- 280A Pulse Current Capability
- Triggering Voltage of 190 to 280V
- RoHS Compliant

Applications

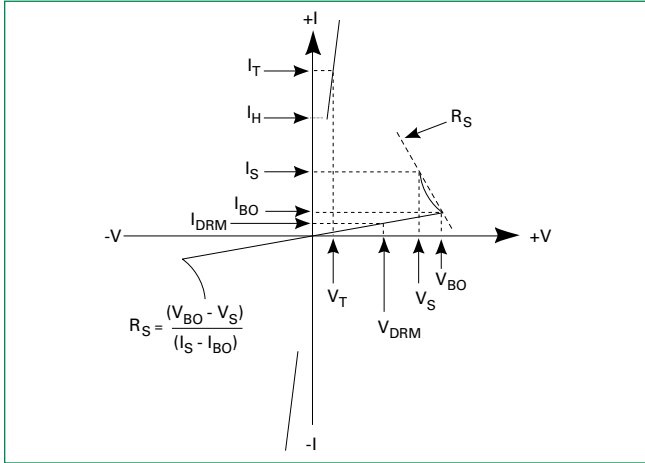
Suitable for high voltage power supplies, natural gas igniters, and Xenon flash ignition.

Electrical Specifications (T<sub>J</sub> = 25°C, unless otherwise specified)

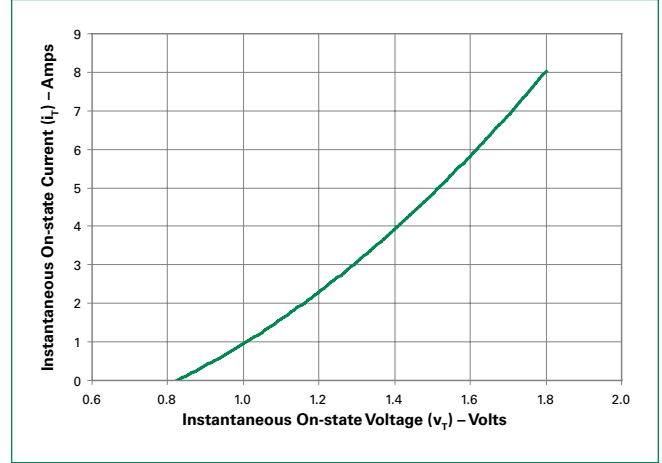
| Symbol               | Parameters  | Test Conditions                            | Min  | Max | Unit |
|----------------------|---|--|------|-----|------|
| V <sub>BO</sub>      | Breakover/Trigger Voltage   | K2000yH                                    | 190  | 215 | V    |
|                      |   | K2200yH                                    | 205  | 230 |      |
|                      |   | K2400yH                                    | 220  | 250 |      |
|                      |   | K2500yH                                    | 240  | 280 |      |
| V <sub>DRM</sub>     | Repetitive Peak Off-state Voltage                                   | K2000yH                                    | 180  |     | V    |
|                      |   | K2200yH                                    | 180  |     |      |
|                      |   | K2400yH                                    | 190  |     |      |
|                      |   | K2500yH                                    | 200  |     |      |
| I <sub>TR(RMS)</sub> | On-state RMS Current  | 50/60Hz, T <sub>J</sub> < 125°C            |      | 1   | A    |
| V <sub>TM</sub>      | Peak On-state Voltage   | I <sub>T</sub> = 1A                        |      | 1.5 | V    |
| I <sub>H</sub>       | Dynamic Holding Current   | R <sub>T</sub> = 100Ω<br>50/60Hz Sine Wave |      | 150 | mA   |
| R <sub>S</sub>       | Switching Resistance, $R_s = \frac{(V_{BO} - V_s)}{(I_s - I_{BO})}$ | 50/60Hz Sine Wave                          | 100  |     | Ω    |
| I <sub>BO</sub>      | Breakover Current   | 50/60Hz Sine Wave                          |      | 50  | μA   |
| I <sub>TRM</sub>     | Peak Repetitive Pulse Current (refer to figure 4)                   | t <sub>p</sub> = 10μs                      | 60Hz | 120 | A    |
|                      |   |  | 5Hz  | 280 |      |
| di/dt                | Critical Rate of Rise of On-State Current                           |  |      | 150 | A/μs |
| dv/dt                | Critical Rate of Rise of Off-State Voltage                          |  | 1500 |     | V/μs |
| T <sub>S</sub>       | Storage Temperature Range   |  | -40  | 150 | °C   |
| T <sub>J</sub>       | Junction Temperature Range  |  | -40  | 125 | °C   |
| R <sub>θJL</sub>     | Thermal Resistance, Junction to Lead                                | DO-15                                      |      | 18  | °C/W |
|                      |   | DO-214                                     |      | 30  |      |
| R <sub>θJC</sub>     | Thermal Resistance, Junction to Case                                | TO-92                                      |      | 35  | °C/W |
| R <sub>θJA</sub>     | Thermal Resistance, Junction to Ambient                             | DO-15                                      |      | 75  | °C/W |
|                      |   | TO-92                                      |      | 95  |      |

Note: xxx - voltage, y = package

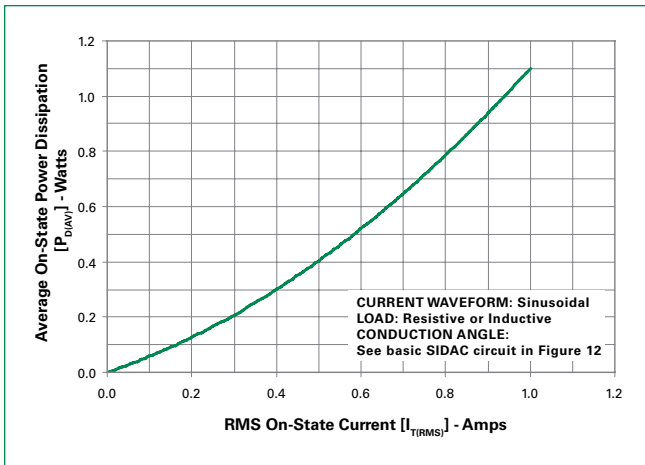
**Figure 1: V-I Characteristics**



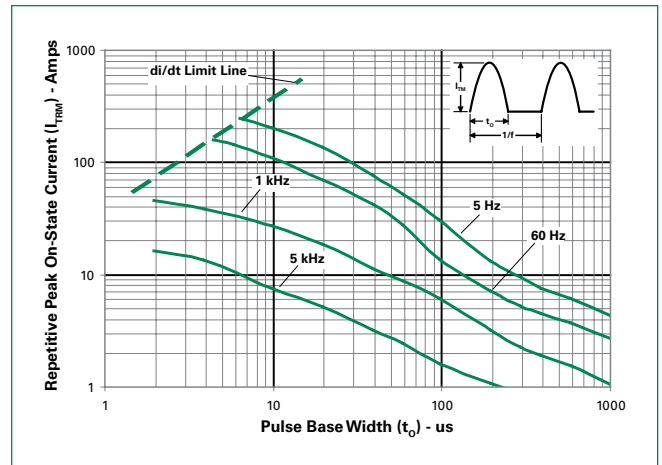
**Figure 2: On-state Current vs. On-state Voltage (Typical)**



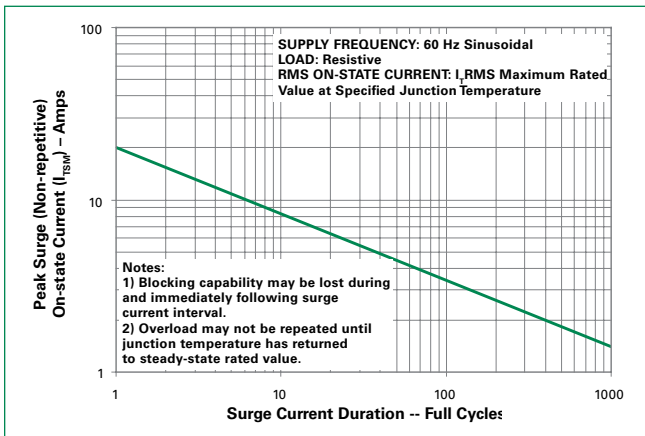
**Figure 3: Power Dissipation vs. On-state Current (Typical)**



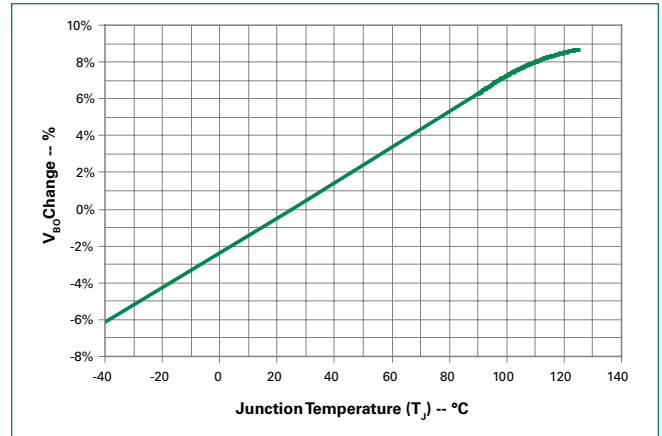
**Figure 4: Repetitive Peak On-state Current ( $I_{TRM}$ ) vs. Pulse Width at Various Frequencies**



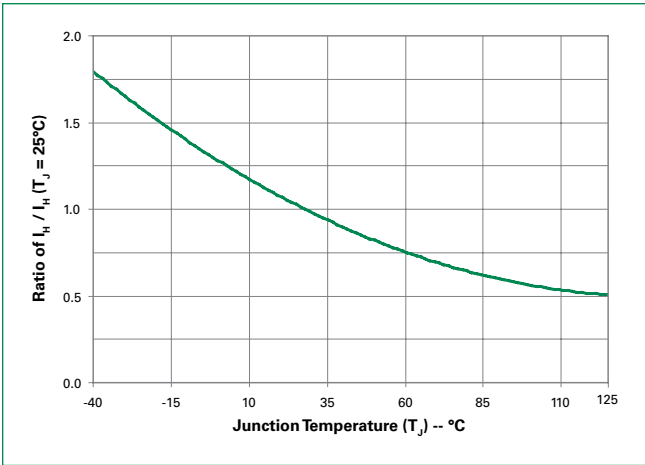
**Figure 5: Surge Peak On-state Current vs. Number of Cycles**



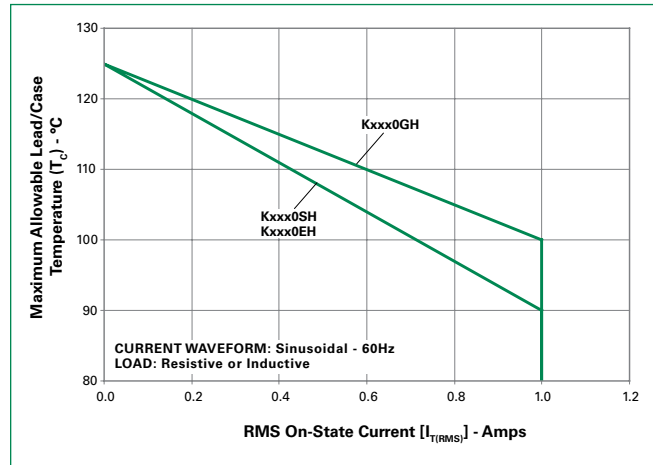
**Figure 6: Normalized  $V_{BO}$  Change vs. Junction Temperature**



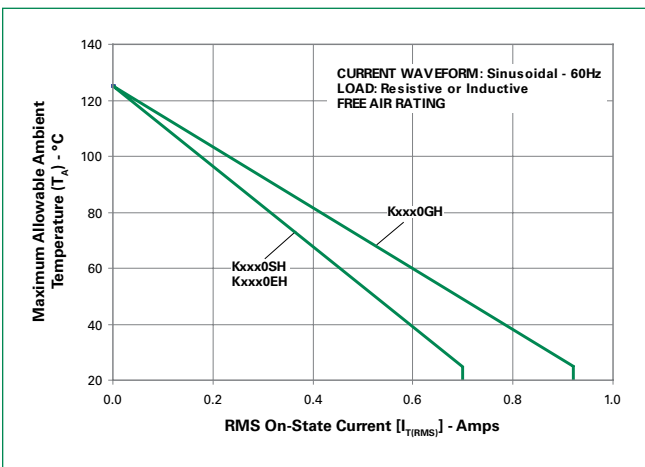
**Figure 7: Normalized DC Holding Current vs. Junction Temperature**



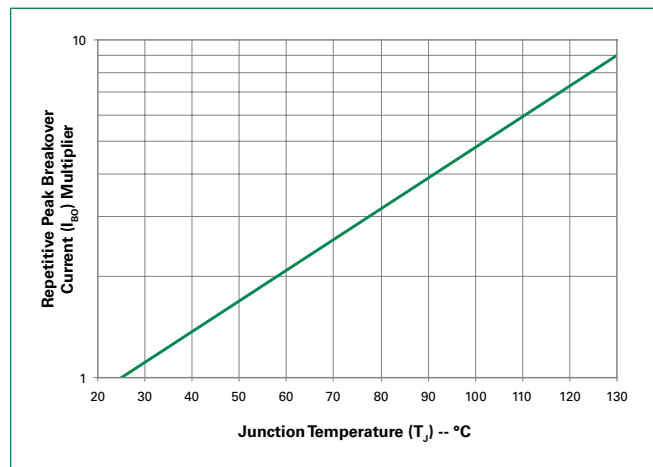
**Figure 8: Maximum Allowable Case Temperature vs. RMS On-State Current**



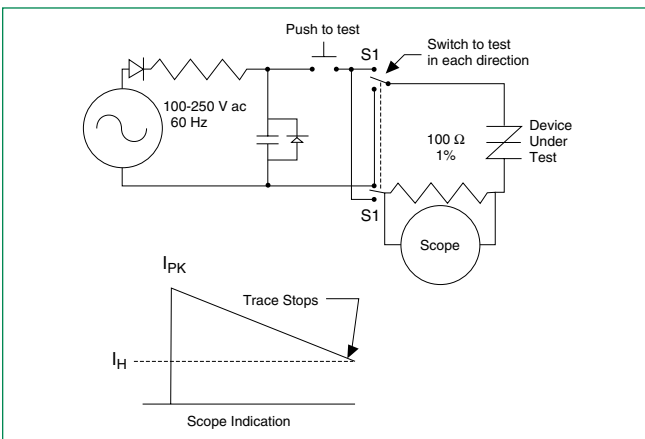
**Figure 9: Maximum Allowable Ambient Temperature vs. RMS On-State Current**



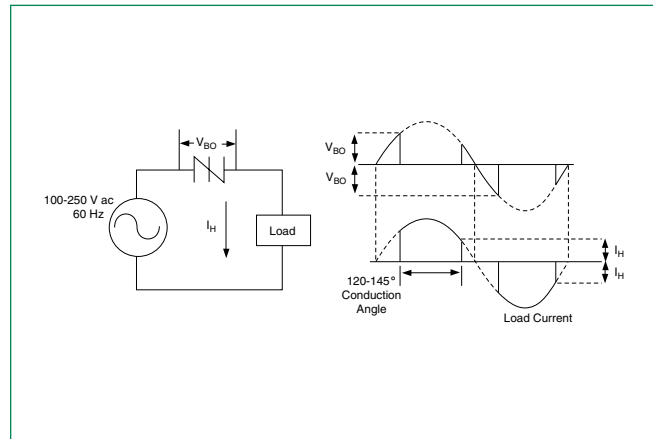
**Figure 10: Normalized Repetitive Peak Breakover Current ( $I_{BO}$ ) vs. Junction Temperature**



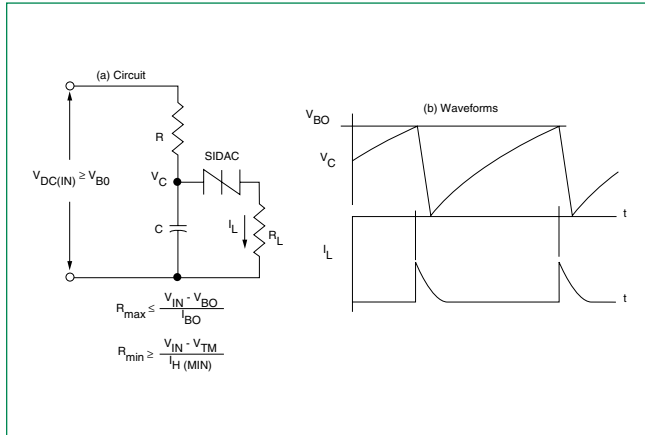
**Figure 11: Dynamic Holding Current Test Circuit for SIDACs**



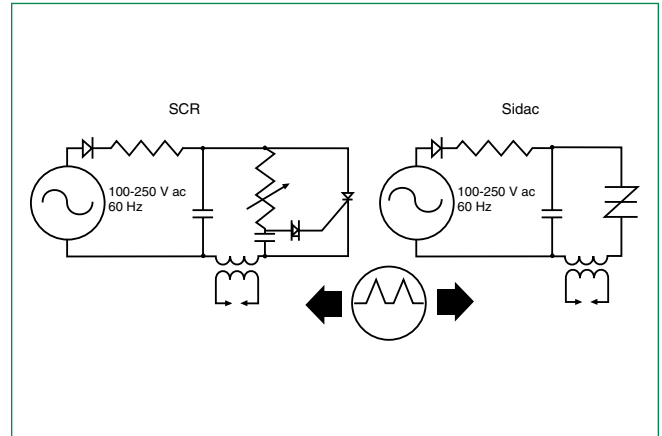
**Figure 12: Basic SIDAC Circuit**



**Figure 13: Relaxation Oscillator Using a SIDAC**

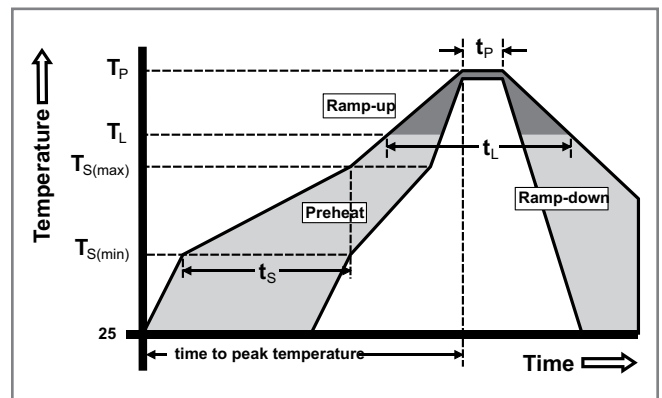


**Figure 14: General Gas Ignitor Circuit**



**Soldering Parameters**

|  |                                    |                         |
|--|------------------------------------|-------------------------|
| Reflow Condition                                       |                                    | Pb – Free assembly      |
| Pre Heat   | - Temperature Min ( $T_{s(min)}$ ) | 150°C                   |
|  | - Temperature Max ( $T_{s(max)}$ ) | 200°C                   |
|  | - Time (min to max) ( $t_s$ )      | 60 – 180 secs           |
| Average ramp up rate (Liquidus Temp ( $T_L$ ) to peak) |                                    | 5°C/second max          |
| $T_{s(max)}$ to $T_L$ - Ramp-up Rate                   |                                    | 5°C/second max          |
| Reflow   | - Temperature ( $T_L$ ) (Liquidus) | 217°C                   |
|  | - Temperature ( $t_L$ )            | 60 – 150 seconds        |
| Peak Temperature ( $T_p$ )                             |                                    | 260 <sup>+0/-5</sup> °C |
| Time within 5°C of actual peak Temperature ( $t_p$ )   |                                    | 20 – 40 seconds         |
| Ramp-down Rate   |                                    | 5°C/second max          |
| Time 25°C to peak Temperature ( $T_p$ )                |                                    | 8 minutes Max.          |
| Do not exceed  |                                    | 280°C                   |



**Additional Information**



**Datasheet**



**Resources**



**Samples**

**Physical Specifications**

|                          |  |
|--------------------------|--|
| <b>Terminal Material</b> | Copper Alloy   |
| <b>Terminal Finish</b>   | 100% Matte Tin-plated /Pb Free solder dipped.                  |
| <b>Body Material</b>     | UL recognized epoxy meeting flammability classification 94V-0. |

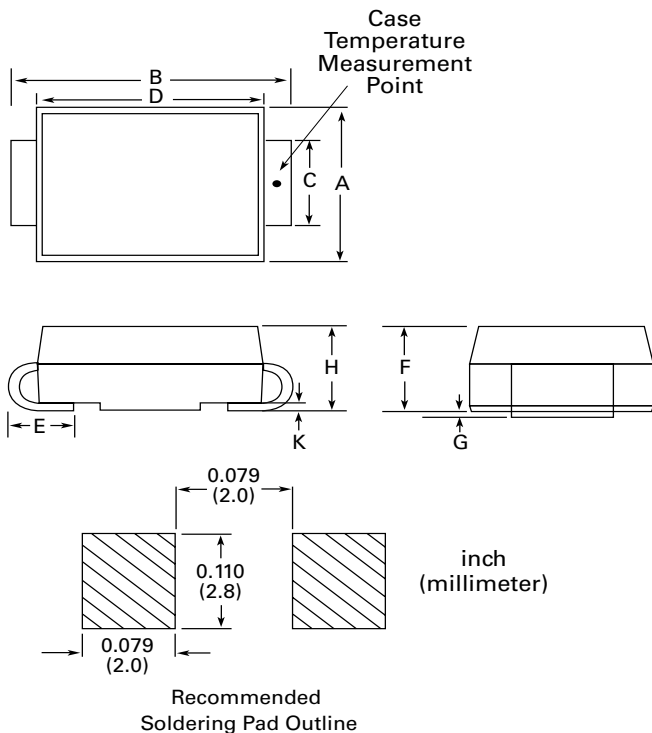
**Design Considerations**

Careful selection of the correct device for the application's operating parameters and environment will go a long way toward extending the operating life of the Thyristor. Overheating and surge currents are the main killers of SIDACs. Correct mounting, soldering, and forming of the leads also help protect against component damage.

**Reliability/Environmental Tests**

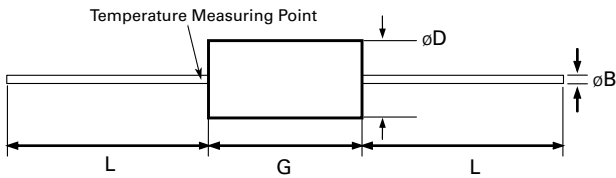
| Test                                     | Specifications and Conditions   |
|--|---|
| <b>High Temperature Voltage Blocking</b> | MIL-STD-750: Method 1040, Condition A Rated $V_{DRM}$ (VAC-peak), 125°C, 1008 hours     |
| <b>Temperature Cycling</b>               | MIL-STD-750: Method 1051<br>-40°C to 150°C, 15-minute dwell, 100 cycles                 |
| <b>Biased Temperature &amp; Humidity</b> | EIA/JEDEC: JESD22-A101 (VDC), 85°C, 85%RH, 1008 hours                                   |
| <b>High Temp Storage</b>                 | MIL-STD-750: Method 1031<br>150°C, 1008 hours   |
| <b>Low-Temp Storage</b>                  | -40°C, 1008 hours   |
| <b>Thermal Shock</b>                     | MIL-STD-750: Method 1056<br>0°C to 100°C, 5-minute dwell, 10-second transfer, 10 cycles |
| <b>Autoclave (Pressure Cooker Test)</b>  | EIA/JEDEC: JESD22-A102<br>121°C, 100%RH, 2atm, 168 hours                                |
| <b>Resistance to Solder Heat</b>         | MIL-STD-750: Method 2031<br>260°C, 10 seconds   |
| <b>Solderability</b>                     | ANSI/J-STD-002: Category 3  |
| <b>Repetitive Surge Life Testing</b>     | MIL-STD-750: Method 2036, Condition E   |

**Dimensions — DO-214**



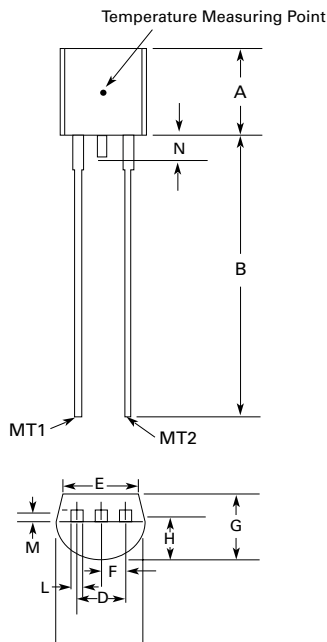
| Dimension | Inches |       | Millimeters |      |
|-----------|--------|-------|-------------|------|
|           | Max    | Max   | Min         | Max  |
| A         | 0.130  | 0.156 | 3.30        | 3.95 |
| B         | 0.201  | 0.220 | 5.10        | 5.60 |
| C         | 0.077  | 0.087 | 1.95        | 2.20 |
| D         | 0.159  | 0.181 | 4.05        | 4.60 |
| E         | 0.030  | 0.063 | 0.75        | 1.60 |
| F         | 0.075  | 0.096 | 1.90        | 2.45 |
| G         | 0.002  | 0.008 | 0.05        | 0.20 |
| H         | 0.077  | 0.104 | 1.95        | 2.65 |
| K         | 0.006  | 0.016 | 0.15        | 0.41 |

**Dimensions — DO-15**



| Dimension | Inches |       | Millimeters |       |
|-----------|--------|-------|-------------|-------|
|           | Max    | Max   | Min         | Max   |
| øB        | 0.028  | 0.034 | 0.711       | 0.864 |
| øD        | 0.120  | 0.140 | 3.048       | 3.556 |
| G         | 0.235  | 0.270 | 5.969       | 6.858 |
| L         | 1.000  |       | 25.400      |       |

**Dimensions - TO-92 with Type 70 Lead Form**



| Dimension | Inches |       | Millimeters |      |
|-----------|--------|-------|-------------|------|
|           | Max    | Max   | Min         | Max  |
| A         | 0.176  | 0.196 | 4.47        | 4.98 |
| B         | 0.500  |       | 12.70       |      |
| C         | 0.095  | 0.105 | 2.41        | 2.67 |
| D         | 0.150  |       | 3.81        |      |
| E         | 0.046  | 0.054 | 1.16        | 1.37 |
| F         | 0.135  | 0.145 | 3.43        | 3.68 |
| G         | 0.088  | 0.096 | 2.23        | 2.44 |
| H         | 0.176  | 0.186 | 4.47        | 4.73 |
| I         | 0.088  | 0.096 | 2.23        | 2.44 |
| J         | 0.013  | 0.019 | 0.33        | 0.48 |
| K         | 0.013  | 0.017 | 0.33        | 0.43 |
| L         |        | 0.060 |             | 1.52 |

**Notes:**

1. Type 70 lead form as shown is standard for the E package.
2. All leads are insulated from case. Case is electrically nonconductive (rated at 16000V ac rms for one minute from leads to case over the operating temperature range.)
3. Mold flash shall not exceed 0.13 mm per side.

**Product Selector**

| Part Number | Switching Voltage Range |                         | Blocking Voltage | Packages |         |           |
|-------------|-------------------------|-------------------------|------------------|----------|---------|-----------|
|             | V <sub>BO</sub> Minimum | V <sub>BO</sub> Maximum | V <sub>DRM</sub> | DO-15    | DO-214  | TO-92     |
| K2000yH     | 190V                    | 215V                    | 180V             | K2000GH  | K2000SH | K2000EH70 |
| K2200yH     | 205V                    | 230V                    | 180V             | K2200GH  | K2200SH | K2200EH70 |
| K2400yH     | 220V                    | 250V                    | 190V             | K2400GH  | K2400SH | K2400EH70 |
| K2500yH     | 240V                    | 280V                    | 200V             | K2500GH  | K2500SH | K2500EH70 |

Note: y = package

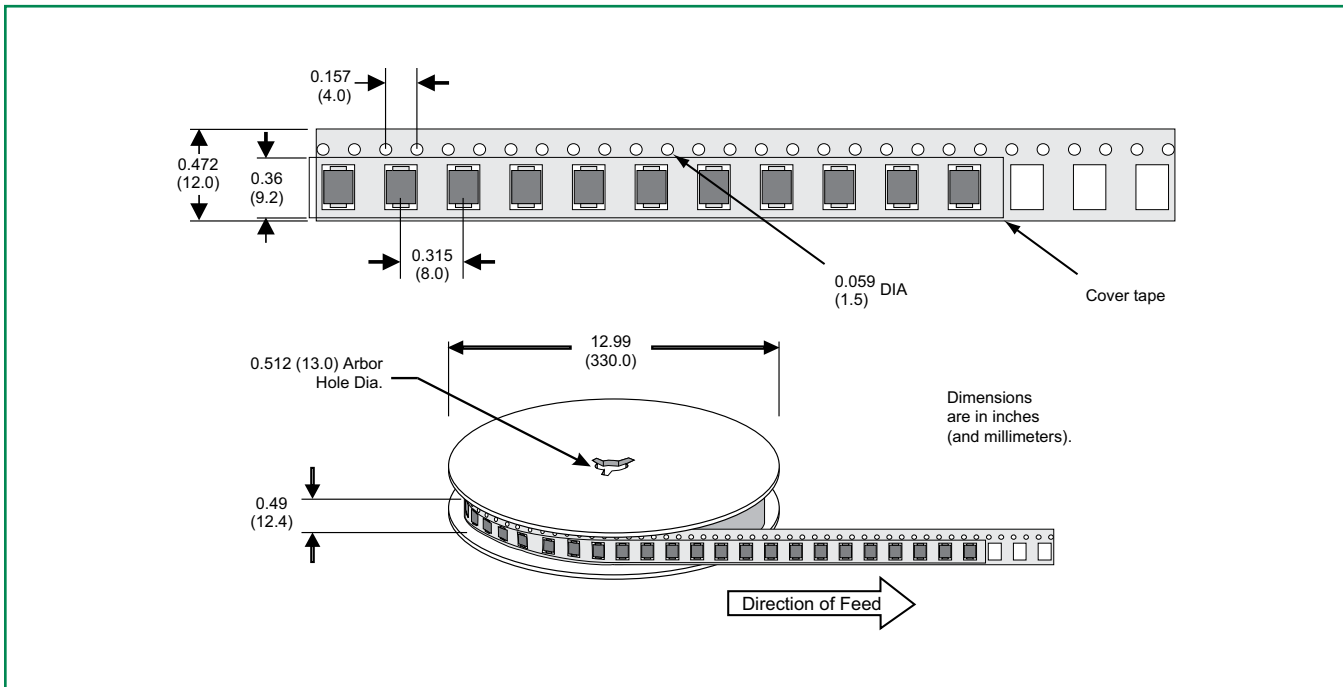
**Packing Options**

| Part Number  | Marking | Weight | Packaging Mode | Base Quantity |
|--------------|---------|--------|----------------|---------------|
| Kxxx0GH      | Kxxx0GH | 0.38g  | Bulk           | 1000          |
| Kxxx0GHRP    | Kxxx0GH | 0.38g  | Reel Pack      | 5000          |
| Kxxx0SHRP    | KxxSH   | 0.1g   | Reel Pack      | 2500          |
| Kxxx0EH70    | Kxxx0EH | 0.17g  | Bulk           | 2000          |
| Kxxx0EH70AP  | Kxxx0EH | 0.17g  | Ammo Pack      | 2000          |
| Kxxx0EH70RP2 | Kxxx0EH | 0.17g  | Reel Pack      | 2000          |
| Kxxx0EH70RP3 | Kxxx0EH | 0.17g  | Reel Pack      | 2000          |

Note: xxx or xx = voltage

**DO-214 Embossed Carrier Reel Pack (RP) Specifications**

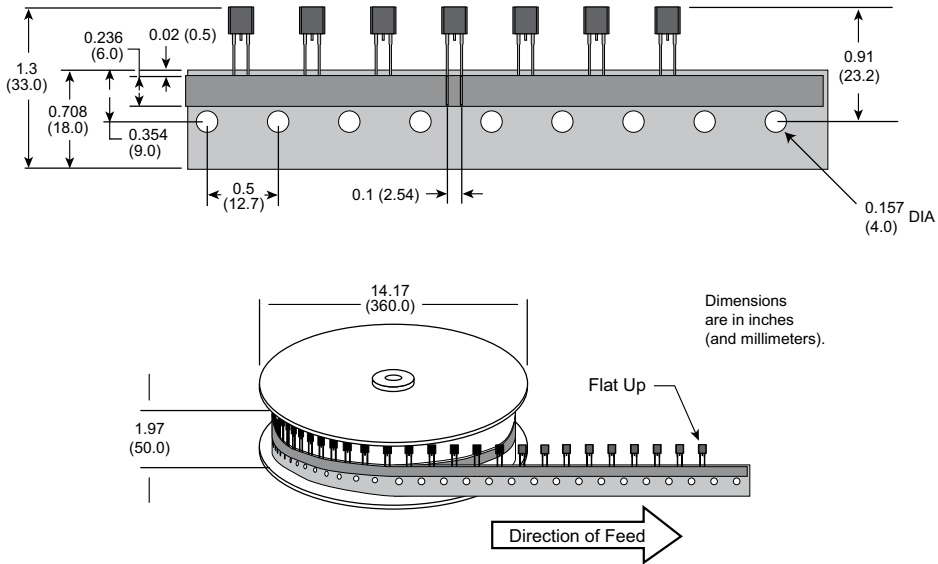
Meets all EIA-481-1 Standards







**TO-92 Type 70 Reel Pack (RP3) Optional Specifications**



**TO-92 Type 70 Reel Pack (RP2) Standard Specifications**

