

**KINGS**<sup>®</sup>  
by WINCHESTER  
ELECTRONICS

# RF CONNECTOR SOLUTIONS



Connecting Innovation to Application<sup>®</sup>



# WINCHESTER ELECTRONICS

CONNECTING INNOVATION TO APPLICATION™



Winchester Electronics was established in 1941 and is today a global leader in the design, development, and deployment of interconnect technology. Headquartered in Middlebury, Connecticut, USA, Winchester operates worldwide with modern, electronically linked design, manufacturing, sales, and distribution facilities in the United States, Mexico, China, and Malaysia.

Winchester's competitive advantage is our ability to solve even the most difficult interconnect problems, deploy design solutions globally to meet the customer's manufacturing needs, and offer true supply chain management techniques to deliver value through our high-mix, low-volume manufacturing model. Our global IT infrastructure and worldwide communication capabilities allow for continuous information access in support of customer opportunities. The acquisition of Kings Electronics expanded our technological capabilities and broadened our market base and product offering.

Kings Electronics was originally founded in 1947 and has provided numerous contributions to the advancement of connector technology, including the K-Grip® crimp style connector, True 75 Ohm BNC connectors, and the industry standard Tri-Loc® triaxial camera connector

series. This long-trusted RF KINGS® Brand is highly regarded by customers in the Broadcast, Telecommunications, and Commercial and Military Aviation industries.

With over 125 years of collective industry experience, Winchester Electronics and the KINGS® Brand create value for our customers by offering a proven combination of quality products, efficient manufacturing, dedicated service, and inventive design solutions.

In addition to the KINGS® Brand RF Connectors, Winchester Electronics also manufactures a wide variety of PCB and Power Connectors, as well as value-added cable and electromechanical assemblies for customers in the Wireless Infrastructure, Computer, Industrial, and Medical Equipment industries.

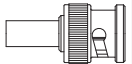
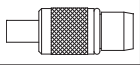
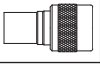
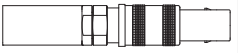
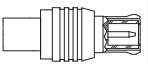
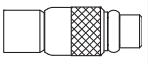
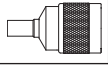
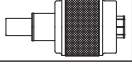
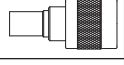


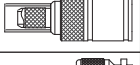




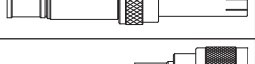
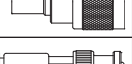


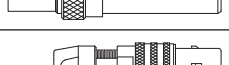
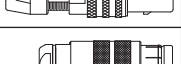
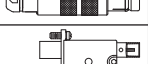

Realizing its responsibility to the environment, every Winchester Electronics facility is ISO Certified and all of our products are manufactured in compliance with the European Union RoHS directive.

Providing superior products built to stringent specifications, the new Winchester Electronics is a valuable extension of your product development team. With the ability to rapidly develop engineered solutions at reduced costs and time-to-market, we can help your company maintain its competitive edge.

Connector Selection Guide	04
50 Ohm BNC Series	05
BMA Series	16
C Series	20
K-Loc® Series	24
MCX Series	26
MMCX Series	29
N Series	32
QC-N Series	42
SC Series	44
SMA Series	47
QC-SMA™ Series	59
SMB Series	61
TNC Series	66
TRB Series	81
TRT Series	84
10 KV Series	86
20 KV Series	88
HN Series	90
MHV Series	93
SHV Series	96
75 Ohm BNC Series	99
Long Barrel BNC	102
Patch Plugs	104
Patch Cord Assemblies	106
Tri-Loc®	108
International Tri-Loc®	113
1.0/2.3 DIN	116
Audio/Video Patching System	118
Mid-Size Video Jacks & Jackfields	120
Standard-Size Video Jacks & Jackfields	122
Populated Video Jackfields	124
Tools & Accessories	127
Strain Relief Boots	128
Installation Tools	130
Splices	131
Mounting Holes	132
Cable Procedures	134
Cable Reference Table	235
KINGS® Cable Groups	239
Glossary	241
Military to KINGS® Cross-Reference Chart	242
Part Number Index	245



# CONNECTOR SELECTION GUIDE

	Series	Cable Type	Size	Coupling	Impedance	Max Frequency	Max VSWR	Voltage Rating
	BNC	Coaxial	Miniature	Bayonet	50 & 75 Ohm	4 GHz	1.3	500 VRMS
	BMA	Coaxial	Sub-Miniature	Blind Mate	50 Ohm	18 GHz	1.1	1000 VRMS
	C	Coaxial	Medium	Bayonet	50 Ohm	11 GHz	1.4	1000 VRMS
	K-Loc®	Coaxial	Miniature	Positive Lock	50 Ohm	—	—	500 VRMS
	MCX	Coaxial	Micro-Miniature	Snap On	50 & 75 Ohm	6 GHz	1.3	335 VRMS
	MMCX	Coaxial	Micro-Miniature	Snap On	50 Ohm	6 GHz	1.3	170 VRMS
	N	Coaxial	Medium	Threaded	50 Ohm	11 GHz	1.3	1000 VRMS
	QC-N™	Coaxial	Medium	Snap On	50 Ohm	11 GHz	1.2	1000 VRMS
	SC	Coaxial	Medium	Threaded	50 Ohm	11 GHz	1.3	1000 VRMS
	SMA	Coaxial	Sub-Miniature	Threaded	50 Ohm	18 GHz	1.3	500 VRMS
	QC-SMA™	Coaxial	Sub-Miniature	Snap On	50 Ohm	6 GHz	1.3	335 VRMS
	SMB	Coaxial	Sub-Miniature	Snap On	50 & 75 Ohm	4 GHz	1.5	250 VRMS
	TNC	Coaxial	Miniature	Threaded	50 & 75 Ohm	11 GHz	1.3	500 VRMS
	TRB	Triaxial	Miniature	Bayonet	Non-Constant	500 MHz	—	400 VRMS
	TRT	Triaxial	Miniature	Threaded	Non-Constant	500 MHz	—	400 VRMS
	10 KV	Coaxial	Medium	Bayonet	Non-Constant	—	—	10 KV DC
	20 KV	Coaxial	Medium	Bayonet	Non-Constant	—	—	20 KV DC
	HN	Coaxial	Medium	Threaded	50 Ohm	4 GHz	1.3	1500 VRMS
	MHV	Coaxial	Miniature	Bayonet	Non-Constant	500 MHz	—	3500 VRMS
	SHV	Coaxial	Miniature	Bayonet	Non-Constant	300 MHz	—	3500 VRMS
	Patch Plugs	Coaxial	Medium	Push On	75 Ohm	2.5 GHz	—	500 VRMS
	Tri-Loc®	Triaxial	Large	Push On	75 Ohm	2.5 GHz	—	1500 VRMS
	International Tri-Loc®	Triaxial	Large	Push On	75 Ohm	3.0 GHz	—	1500 VRMS
	Audio/Video Patching Systems	See Catalog Pages 112-113 for Further Details.						





- 50 Ohm Nominal Impedance.
- Quick connect & disconnect bayonet coupling design.
- Durable brass bodies with Silver or Nickel plating.
- Small & lightweight.
- Commercial and Military-Specified versions available.
- Frequency Range: Up to 4 GHz

**SPECIFICATIONS**

**MATERIAL**

Body:	Brass
Crimp Sleeves:	Commercial Bronze Alloy
Center Contacts:	Brass (Male) Beryllium Copper (Female)
Outer Contacts:	Beryllium Copper or Brass (Male)
Insulators:	PTFE
Gaskets & Seals:	Silicone Rubber

**FINISHES**

Body:	Silver or Nickel
Center Contacts:	Gold

**ENVIRONMENTAL**

Temperature Range:	-65° C to +165° C
Vibration:	MIL-STD-202, Method 204, Condition B
Shock:	MIL-STD-202, Method 213, Condition B
Corrosion:	MIL-STD-202, Method 101, Condition B
Moisture Resistance:	MIL-STD-202, Method 106

**ELECTRICAL**

Impedance:	50 Ohms
Frequency Range:	DC to 4 GHz
Voltage Rating:	500 Volts RMS
VSWR:	1.30 Max, DC to 4 GHz
Insertion Loss:	.2 dB Max at 3 GHz

**MECHANICAL**

Life:	500 Cycles
Cable Retention:	Non-Crimp: 40 Pounds Minimum Crimp: 10 to 40 Pounds, Depending on Cable Size

**INTERFACE DIMENSIONS**



Dimensions in inches with metric equivalents (mm) in parentheses					
Dim Ltr	Minimum	Maximum	Dim Ltr	Minimum	Maximum
A	.355 (9.76)	.390 (9.91)	E	.210 (5.33)	.230 (5.84)
B	Gauge Test		F	.006 (0.15)	
C	.190 (4.83)		L	.003 (0.08)	
D	.052 (1.32)	.054 (1.37)	P	.208 (5.28)	.228 (5.79)



Dim Ltr	Minimum	Maximum	Dim Ltr	Minimum	Maximum
A	.432 (10.97)	.436 (11.07)	J	.186 (4.72)	.206 (5.23)
B	.378 (9.60)	.382 (9.70)	K		.006 (0.15)
C	.327 (8.31)	.333 (8.46)	N	.346 (8.79)	.356 (9.04)
D	.319 (8.10)	.321 (8.15)	P		.256 (6.50)
E		.186 (4.72)	R	.015 (0.38)	.030 (0.76)
F	.204 (5.18)	.208 (5.28)	S	.414 (10.52)	
G	.327 (8.31)	.335 (8.51)	T	.188 (4.78)	.208 (5.28)
H	.075 (1.91)	.081 (2.06)			

## PLUG - CONVENTIONAL



FIGURE 1

## PLUG - TAPER GRIP

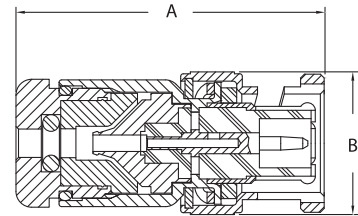


FIGURE 2

## PLUGS - K-GRIP

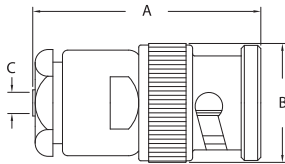


FIGURE 3

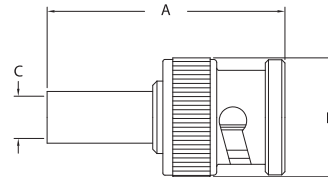


FIGURE 4

Item Number	Military PN	Product Description	Gender	Finish	Dimensions				Cable Group	Cable Procedure	Crimp Die	Mounting Hole	Figure #
					A	B	C	D					
KC-59-588 M06		Plug, Direct Solder	M	Nickel	0.750	0.560			49	3-81	NONE		N/S
KC-59-89		Plug, Conventional	M	Silver	1.090	0.570	0.120		B	CP-1004	NONE		1
KC-59-284		Plug, Conventional	M	Nickel	1.080	0.560			B1	CP-1004.1	NONE		1
KC-59-544	M39012/16-0101	Plug, Conventional	M	Silver	1.080	0.560			DE	CP-1050	NONE		1
KC-59-141		Plug, Conventional	M	Nickel	1.090	0.560			DE	CP-1004	NONE		1
KC-59-545	M39012/16-0102	Plug, Conventional	M	Silver	1.080	0.560			G1	CP-1050	NONE		1
KC-59-548	M39012/16-0118	Plug, Conventional	M	Silver	1.080	0.560			H	CP-1050	NONE		1
KC-59-248 M06		Plug, Conventional	M	Nickel	1.660	0.750			MN	CP-1005	NONE		1
KC-59-248		Plug, Conventional	M	Silver	1.660	0.750			M1	CP-1005	NONE		1
755-86-5	M39012/16-0220	Plug, Taper Grip	M	Silver	1.250	0.593			3	3-562	NONE		2
755-100-5		Plug, Taper Grip	M	Silver	1.250	0.593			B1	3-562	NONE		2
755-74-5	M39012/16-0101	Plug, Taper Grip	M	Silver	1.250	0.560			D	3-561	NONE		2
KC-59-175		Plug, Conventional/Crimp	M	Nickel	1.080	0.560			A	CP-228A	KTH-2008		3
KC-59-136		Plug, Conventional/Crimp	M	Silver	1.080	0.560			A	CP-228A	KTH-2008		3
KC-59-111	M39012/16B0009	Plug, Conventional/Crimp	M	Silver	1.150	0.570			C1	CP-226A-2	KTH-2007		3
KC-59-61	M39012/16B0004	Plug, Conventional/Crimp	M	Silver	1.170	0.560			D	CP-201A	KTH-2001		3
KC-59-188	M39012/16B0007	Plug, Conventional/Crimp	M	Silver	1.170	0.570			E2	CP-201A	KTH-2001		3
KC-59-239		Plug, Conventional/Crimp, Polarized	M	Silver	1.090	0.560	0.150		B	CP-225A	KTH-2024		3
KC-59-156		Plug, Conventional/Crimp, Polarized	M	Nickel	1.170	0.560			D	CP-201A	KTH-2001		3
KC-59-155		Plug, Conventional/Crimp, Polarized	M	Silver	1.170	0.560			D	CP-201A	KTH-2001		3
KC-59-288		Plug, Crimp, Booted	M	Nickel	1.910	0.560			B1	CP-425	KTH-2024		4
KC-59-184		Plug, Crimp, Booted	M	Silver	1.910	0.560			D	CP-420	KTH-2001		4
KC-59-358		Plug, Crimp, Booted	M	Nickel	1.900	0.560			G1	CP-420	KTH-2002		4

PLUGS - K-GRIP, JR

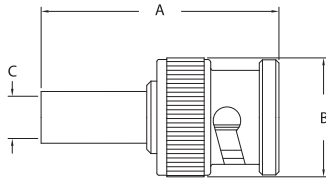


FIGURE 4

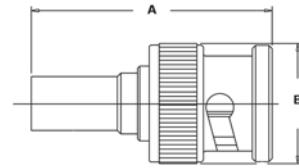


FIGURE 5

Item Number	Military PN	Product Description	Gender	Finish	Dimensions				Cable Group	Cable Procedure	Crimp Die	Mounting Hole	Figure #
					A	B	C	D					
KC-59-482		Plug, Crimp	M	Nickel	1.100	0.570			24	CP-401	KTH-2002		4
KC-59-485		Plug, Crimp	M	Nickel	1.780	0.560			81	CP-5402	KTH-2004		4
755-129-9		Plug, Crimp	M	Nickel	0.910	0.560			B1	CP-406	KTH-2032		4
KC-59-95		Plug, Crimp	M	Silver	0.910	0.560			B1	CP-406	KTH-2032		4
755-63-9		Plug, Crimp	M	Nickel	1.060	0.490			B2	3-483-2	KTH-2021		4
KC-59-107		Plug, Crimp	M	Silver	0.980	0.560	0.180		C	CP-409	KTH-2007		4
755-116-5	M39012/16-0016	Plug, Crimp	M	Silver	1.120	0.570			C1	CP-465	KTH-2007		4
755-119-5	M39012/16-0501	Plug, Crimp	M	Silver	1.120	0.560			C1	CP-465	KTH-2007		4
755-120-5	M39012/16-0502	Plug, Crimp	M	Silver	1.120	0.560			C2	CP-465	KTH-2007		4
755-114-9		Plug, Crimp	M	Nickel	1.120	0.560			D	CP-465	KTH-2001		4
755-114-5	M39012/16-0013	Plug, Crimp	M	Silver	1.120	0.560			D	CP-465	KTH-2001		4
755-122-5	M39012/16-0504	Plug, Crimp	M	Silver	1.120	0.560			D	CP-465	KTH-2001		4
755-112-9		Plug, Crimp	M	Nickel	1.120	0.560			E1	CP-465	KTH-2001		4
755-112-5	M39012/16-0014	Plug, Crimp	M	Silver	1.120	0.560			E1	CP-465	KTH-2001		4
755-121-5	M39012/16-0503	Plug, Crimp	M	Silver	1.120	0.560			E1	CP-465	KTH-2001		4
755-115-5	M39012/16-0015	Plug, Crimp	M	Silver	1.120	0.560			G1	CP-465	KTH-2002		4
755-117-5	M39012/16-0017	Plug, Crimp	M	Silver	1.120	0.560			G2	CP-465	KTH-2002		4
755-118-5	M39012/16-0020	Plug, Crimp	M	Silver	1.120	0.560			H	CP-465	KTH-2002		4
KC-59-577 M06		Plug, Crimp	M	Nickel	1.690	0.590			M1	CP-480	KTH-2004		4
755-128-9		Plug, Crimp, Weatherproof	M	Nickel	1.060	0.560	0.120		B1	CP-402	KTH-2081		5
KC-59-280		Plug, Crimp, Weatherproof	M	Silver	1.080	0.560			B1	CP-402	KTH-2081		5
KC-59-446		Plug, Crimp, Weatherproof	M	Nickel	1.140	0.560			C2	CP-5401	KTH-2067		5
755-127-9		Plug, Crimp, Weatherproof	M	Nickel	1.140	0.560			D	CP-465	KTH-2061		5
KC-59-195	M39012/16B0004	Plug, Crimp, Weatherproof	M	Silver	1.120	0.570			DE	CP-401	KTH-2061		5
KC-59-383		Plug, Crimp, Weatherproof	M	Nickel	1.130	0.570			E1	CP-472	KTH-2061		5
KC-59-232		Plug, Crimp, Weatherproof	M	Nickel	1.140	0.570			G1	CP-401	KTH-2062		5
KC-59-220	M39012/16B0008	Plug, Crimp, Weatherproof	M	Silver	1.110	0.560			G1	CP-401	KTH-2062		5
755-79-9		Plug, Crimp, Weatherproof	M	Nickel	1.330	0.593			15	3-564-1	KTH-2214		5
755-78-9		Plug, Crimp, Weatherproof	M	Nickel	1.110	0.593			16	3-546-1	KTH-2161		5
755-93-9		Plug, Crimp, Weatherproof	M	Nickel	1.140	0.593			17	3-546-1	KTH-2216		5
755-104-9		Plug, Crimp, Weatherproof	M	Nickel	1.100	0.570			19	3-546-2	KTH-2213		5
KC-59-267		Plug, Crimp, Weatherproof	M	Nickel	1.690	0.750	0.630		45	CP-5401	KTH-2161		5



ANGLE PLUG - CONVENTIONAL



FIGURE 6

ANGLE PLUG - K-GRIP, JR.



FIGURE 7

ANGLE PLUG - TAPER GRIP



FIGURE 8

Item Number	Military PN	Product Description	Gender	Finish	Dimensions				Cable Group	Cable Procedure	Crimp Die	Mounting Hole	Figure #
					A	B	C	D					
KC-59-533	M39012/20-0101	Plug, Conventional, Angle	M	Silver	1.130	1.530	0.500	0.880	D	CP-1050	NONE		6
756-10-9		Plug, Crimp, Angle, Weatherproof	M	Nickel	1.030	1.440	0.379	0.840	15	3-546-1	KTH-2214		7
756-16-9		Plug, Crimp, Angle, Weatherproof	M	Nickel	1.130	1.740	0.379	0.890	16	3-546-1	KTH-2161		7
756-18-9		Plug, Crimp, Angle, Weatherproof	M	Nickel	1.130	1.730	0.379	0.890	17	3-546-1	KTH-2216		7
KC-59-447		Plug, Crimp, Angle, Weatherproof	M	Nickel	1.130	1.700	0.370	0.890	45	CP-5401	KTH-2161		7
KC-59-109		Plug, Crimp, Angle	M	Silver	1.030	1.430	0.370	0.840	B1	CP-406	KTH-2032		7
756-6-9		Plug, Crimp, Angle	M	Nickel	0.930	0.790	0.375	0.750	B2	3-483-1	KTH-2021		7
KC-59-408	M39012/20-0501	Plug, Crimp, Angle	M	Silver	1.700	1.130	0.570		C1	CP-465	KTH-2007		7
KC-59-418	M39012/20-0502	Plug, Crimp, Angle	M	Silver	1.130	1.700	0.370	0.890	C2	CP-465	KTH-2007		7
756-21-7	M39012/20-0006	Plug, Crimp, Angle	M	Silver	1.030	1.490	0.379	0.840	D	CP-465	KTH-2001		7
KC-59-420	M39012/20-0504	Plug, Crimp, Angle	M	Silver	1.130	1.700	0.370	0.890	D	CP-465	KTH-2001		7
KC-59-270		Plug, Crimp, Angle	M	Nickel	1.030	1.600	1.320	0.850	E1	CP-401	KTH-2001		7
756-19-7	M39012/20-0007	Plug, Crimp, Angle	M	Silver	1.030	1.490	0.379	0.840	E1	CP-465	KTH-2001		7
KC-59-419	M39012/20-0503	Plug, Crimp, Angle	M	Silver	1.130	1.700	0.370	0.890	E1	CP-465	KTH-2001		7
KC-59-287		Plug, Crimp, Angle, Weatherproof	M	Nickel	1.040	1.400	0.375	0.840	B1	CP-402	KTH-2081		7
KC-59-261		Plug, Crimp, Angle, Weatherproof	M	Nickel	1.125	1.725	0.380	1.440	D	CP-5401	KTH-2061		7
KC-59-246	M39012/20B0003	Plug, Crimp, Angle, Weatherproof	M	Silver	1.040	1.670	0.560	0.760	E1	3-334	KTH-2061		7
KC-59-444		Plug, Crimp, Angle, Weatherproof	M	Nickel	1.140	1.390	0.437	0.890	G1	CP-5401	KTH-2062		7
KC-59-212		Plug, Crimp, Angle, W/P, Polarized	M	Nickel	1.620	1.040	0.570		D	CP-401	KTH-2061		7
756-9-5	M39012/20-0101	Plug, Taper Grip, Angle	M	Silver	1.218	1.750	0.500	0.880	D	3-561	NONE		8
756-12-5	M39012/20-0102	Plug, Taper Grip, Angle	M	Silver	1.600	1.130	0.500	1.330	G1	3-561	NONE		8

**BULKHEAD JACKS**



FIGURE 9



FIGURE 10



FIGURE 11

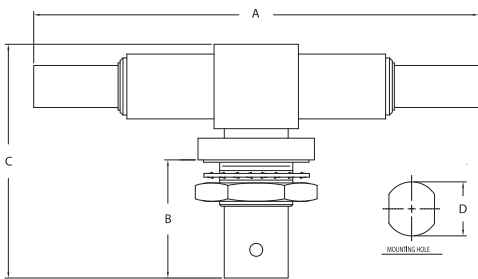


FIGURE 12



FIGURE 13



FIGURE 14

Item Number	Military PN	Product Description	Gender	Finish	Dimensions				Cable Group	Cable Procedure	Crimp Die	Mounting Hole	Figure #
					A	B	C	D					
KC-19-152		Jack, Crimp, Bulkhd	F	Nickel	1.340	0.560	0.500	0.163	B1	CP-430	KTH-2024	C	9
KC-19-258		Jack, Conventional, Bulkhd	F	Nickel	1.140		0.500		50	CP-2101	NONE	B	9
KC-19-110		Jack, Conventional, Bulkhd	F	Silver	1.150	0.810	0.690	0.241	A	CP-1012	NONE	A	10
KC-19-54		Jack, Conventional, Bulkhd	F	Silver	1.150	0.810	0.690		B	CP-1004.1	NONE	A	10
KC-19-50	M39012/19B0003	Jack, Conventional/Crimp, Bulkhd	F	Silver	1.240	0.810	0.690		D	CP-201A	KTH-2001	A	10
752-27-9		Jack, Crimp, Bulkhd	F	Nickel	1.550	0.810	0.630	0.241	24	CP-465	KTH-2002	A	11
KC-19-323 M06		Jack, Crimp, Bulkhd	F	Nickel	1.380	0.910	0.630	0.241	B	CP-5417	KTH-2138	A	11
KC-19-138		Jack, Crimp, Bulkhd, Isolated Ground	F	Nickel	1.265	0.885	0.630	0.173	B1	CP-431	KTH-2032	A	11
KC-19-93		Jack, Crimp, Bulkhd	F	Nickel	1.390	0.810	0.630	0.238	B1	CP-407	KTH-2032	A	11
KC-19-293 M06		Jack, Crimp, Bulkhd	F	Nickel	1.380	0.810	0.630	0.241	B2	CP-5417	KTH-2140	A	11
KC-19-248	M39012/19-0502	Jack, Crimp, Bulkhd	F	Silver	1.400	0.810	0.630	0.241	C2	CP-465	KTH-2007	A	11
KC-19-207	M39012/19-0013	Jack, Crimp, Bulkhd	F	Silver	1.550	0.810	0.690	0.241	D	CP-465	KTH-2001	A	11
KC-19-250	M39012/19-0504	Jack, Crimp, Bulkhd	F	Silver	1.400	0.810	0.690	0.241	D	CP-465	KTH-2001	A	11
KC-19-140		Jack, Crimp, Bulkhd	F	Nickel	1.550	0.810	0.690	0.241	E1	CP-405	KTH-2001	A	11
KC-19-208	M39012/19-0014	Jack, Crimp, Bulkhd	F	Silver	1.550	0.810	0.690	0.241	E1	CP-465	KTH-2001	A	11
KC-19-249	M39012/19-0503	Jack, Crimp, Bulkhd	F	Silver	1.400	0.810	0.630	0.241	E1	CP-465	KTH-2001	A	11
KC-19-212	M39012/19-0020	Jack, Crimp, Bulkhd	F	Silver	1.550	0.806	0.690	0.241	H	CP-465	KTH-2002	A	11
KC-19-122		Jack, Crimp, Bulkhd, Tee	F	Silver	2.680	0.700	1.390	0.500	D	CP-401	KTH-2001		12
KC-19-170		Jack, Crimp, Bulkhd, Weatherproof	F	Nickel	1.580	0.810	0.630	0.241	45	CP-5401	KTH-2161	A	13
KC-19-261		Jack, Crimp, Bulkhd, Weatherproof	F	Nickel	1.580	0.810	0.690	0.241	G1	CP-5401	KTH-2062	A	13
KC-19-175		Jack, Conventional, Bulkhd	F	Nickel	1.150	0.810	0.690	0.241	B1	CP-1004.1	NONE	A	14
752-34-5	M39012/19-0220	Jack, Conventional, Bulkhd	F	Silver	1.250	0.810	0.690		B1	3-562	NONE	A	14
KC-19-282	M39012/19-0101	Jack, Conventional, Bulkhd	F	Silver	1.150	0.810	0.690	0.241	D	CP-1050	NONE	A	14

## JACK - K-GRIP, JR.



FIGURE 15

## PANEL JACK - CONVENTIONAL

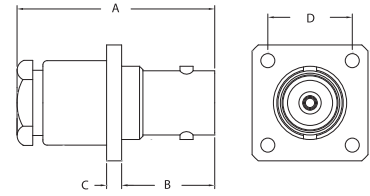


FIGURE 16

## PANEL JACKS - K-GRIP, JR.



FIGURE 17

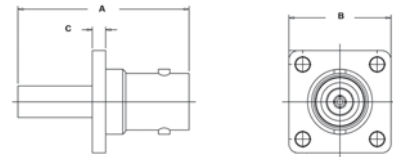


FIGURE 18

Item Number	Military PN	Product Description	Gender	Finish	Dimensions				Cable Group	Cable Procedure	Crimp Die	Mounting Hole	Figure #
					A	B	C	D					
KC-39-50		Jack, Crimp	F	Nickel	0.980	0.560			B1	CP-406	KTH-2032		15
KC-39-105	M39012/17-0502	Jack, Crimp	F	Silver	1.180	0.560			C2	CP-465	KTH-2001		15
KC-39-38		Jack, Crimp	F	Nickel	1.170	0.560			D	CP-401	KTH-2001		15
KC-39-103	M39012/17-0504	Jack, Crimp	F	Silver	1.180	0.560			D	CP-465	KTH-2001		15
KC-39-106	M39012/17-0503	Jack, Crimp	F	Silver	1.180	0.560			E1	CP-465	KTH-2001		15
KC-39-93	M39012/17-0014	Jack, Crimp	F	Silver	1.170	0.560			E1	CP-465	KTH-2001		15
KC-39-45		Jack, Crimp	F	Nickel	1.170	0.560			G1	CP-401	KTH-2002		15
KC-39-98	M39012/17-0020	Jack, Crimp	F	Silver	1.180	0.560			H	CP-465	KTH-2002		15
KC-39-134 M07		Jack, Crimp, Polarized	M	Silver	1.170	0.560			E1	CP-465	KTH-2001		15
KC-19-288 M06		Jack, Conventional, Panel	F	Nickel	1.160	0.550	0.090	0.500	B1	CP-1004.1	NONE		16
KC-19-94		Jack, Conventional, Panel	F	Silver	1.150	0.550	0.090	0.500	B1	CP-1004.1	NONE		16
KC-19-02	M39012/18-0102	Jack, Conventional, Panel	F	Silver	1.150	0.550	0.090	0.500	D	CP-1050	NONE		16
751-11-9		Jack, Crimp, Panel, Weatherproof	F	Nickel	1.540	0.820	0.090		15	3-546-1	KTH-2214		17
751-10-9		Jack, Crimp, Panel, Weatherproof	F	Nickel	1.410	0.820	0.090		16	3-546-1	KTH-2161		17
751-20-9		Jack, Crimp, Panel, Weatherproof	F	Nickel	1.410	0.820	0.090		17	3-546-1	KTH-2216		17
KC-19-129	M39012/18B0007	Jack, Crimp, Panel, Weatherproof	F	Silver	1.180	0.690	0.090		E	CP-401	KTH-2061		17
KC-19-329 M06		Jack, Crimp, Panel, Weatherproof	F	Nickel	1.180	0.690	0.090		C2	CP-5401	KTH-2067		17
KC-19-256		Jack, Crimp, Panel, Weatherproof	F	Nickel	1.440	0.690	0.090		D	CP-5401	KTH-2061		17
KC-19-328 M06		Jack, Crimp, Panel, Weatherproof	F	Nickel	1.440	0.690	0.090		E1	CP-5401	KTH-2061		17
751-26-9		Jack, Crimp, Panel, Weatherproof	F	Nickel	1.810	0.690	0.090		N3	CP-5402	KTH-2105		17
751-22-9		Jack, Crimp, Panel, W/P, Locking Threads	F	Nickel	1.410	0.690	0.090		16	3-546-1	KTH-2161		17
KC-19-244	M39012/18-0502	Jack, Crimp, Panel	F	Silver	1.180	0.690	0.090		C2	CP-465	KTH-2007		18
KC-19-239		Jack, Crimp, Panel	F	Silver	1.410	0.690	0.090		E1	CP-465	KTH-2001		18
KC-19-245	M39012/18-0503	Jack, Crimp, Panel	F	Silver	1.180	0.690	0.090		E1	CP-465	KTH-2001		18



**ACCESSORIES**

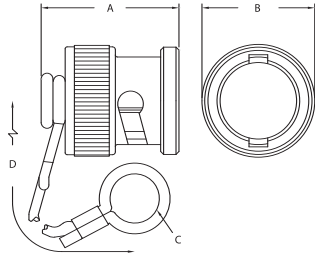


FIGURE 19

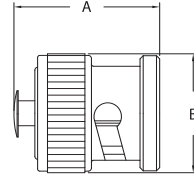


FIGURE 20

**JACK - CONVENTIONAL**

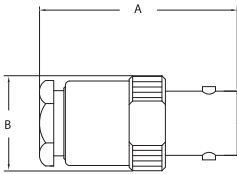


FIGURE 21

**RECEPTACLE**

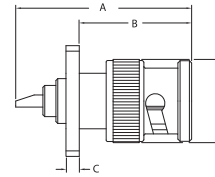


FIGURE 22

Item Number	Military PN	Product Description	Gender	Finish	Dimensions				Cable Group	Cable Procedure	Crimp Die	Mounting Hole	Figure #
					A	B	C	D					
KC-89-59		Dust Cap & Chain	M	Olive Drab	0.700	0.560	0.250	2.000	NONE	NONE	NONE		19
KC-89-87	M39012/25-0006	Dust Cap & Chain	M	Silver	0.670	0.550	0.140	2.250	NONE	NONE	NONE		19
758-42-9		Dust Cap & Nylon Cord	M	Nickel	0.700	0.560	1.250	2.000	NONE	NONE	NONE		19
KC-89-39		Dust Cap & Nylon Cord	M	Olive Drab	0.700	0.560	0.250	2.500	NONE	NONE	NONE		19
758-8-5	M39012/25-0106	Dust Cap & Nylon Cord	M	Silver	0.700	0.560	0.144	4.000	NONE	NONE	NONE		19
758-33-9		Dust Cap & Safety Chain	M	Nickel	0.670	0.570	0.030	2.700	NONE	NONE	NONE		19
758-36-101		Dust Cap & Safety Chain	M	Olive Drab	0.700	0.560	0.050	2.500	NONE	NONE	NONE		19
KC-89-88	M39012/25-0007	Dust Cap & Safety Chain	M	Silver	0.670	0.570	0.520	2.700	NONE	NONE	NONE		19
KC-89-89	M39012/25-0008	Dust Cap & Safety Chain	F	Silver	0.670	0.520	0.280	3.250	NONE	NONE	NONE		N/S
KC-89-180		Dust Cap & Wire Rope	M	Silver	0.700	0.560	0.140	4.000	NONE	NONE	NONE		19
758-42-3		Dust Cap & Wire Rope	M	Stainless	0.700	0.560	0.144	4.000	NONE	NONE	NONE		19
KC-89-93	M39012/25-0016	Shorting Plug & Chain	M	Silver	0.700	0.550	0.140	2.250	NONE	NONE	NONE		19
758-26-5		Shorting Plug	M	Silver	0.700	0.560			NONE	NONE	NONE		20
KC-89-58		Dust Cap	M	Nickel	0.640	0.550			NONE	NONE	NONE		20
KC-89-92	M39012/25-0015	Dust Cap	M	Silver	0.580	0.550			NONE	NONE	NONE		20
KC-39-30		Jack, Conventional	F	Silver	1.150	0.560			B	CP-1004.1	NONE		21
KC-39-03	M39012/17-0101	Jack, Conventional	F	Silver	1.150	0.560			D	CP-1050	NONE		21
KC-79-51		Receptacle, Panel	M	Nickel	1.190	0.760	0.090	0.560	NONE	SOLDER	NONE		22
UG-1104 A/U		Receptacle, Panel	M	Silver	1.180	0.760	0.090	0.560	NONE	SOLDER	NONE		22

RECEPTACLES

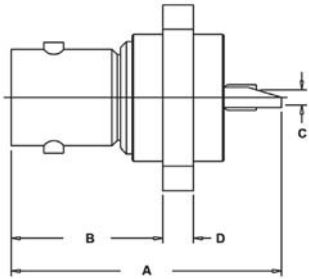


FIGURE 23



FIGURE 24



FIGURE 25



FIGURE 26



FIGURE 27

Item Number	Military PN	Product Description	Gender	Finish	Dimensions				Cable Group	Cable Procedure	Crimp Die	Mounting Hole	Figure #
					A	B	C	D					
KC-79-260 M06		Receptacle, Panel	F	Nickel	1.060	0.630	0.060	0.09	NONE	SOLDER	NONE		23
UG-447 /U		Receptacle, Panel, Rexolite Insulator	F	Silver	1.060	0.630	0.060	0.090	NONE	SOLDER	NONE		23
KC-79-109	M39012/22-0001	Receptacle, Panel, PTFE Insulator	F	Silver	1.060	0.630	0.060	0.090	NONE	SOLDER	NONE		23
KC-79-125		Receptacle, Panel, Iso Grd	F	Nickel	1.060	0.600	0.060	0.090	NONE	SOLDER	NONE		23
757-29-5		Receptacle, Panel, Iso Grd	F	Silver	1.060	0.600	0.060	0.120	NONE	SOLDER	NONE		23
UG-535 /U		Receptacle, Panel, Angle	F	Silver	1.090	0.720			NONE	SOLDER	NONE		24
757-15-9		Receptacle, PCB, Gold Contact	F	Nickel	0.780	0.560	0.090		NONE	SOLDER	NONE		25
KC-79-215		Receptacle, PCB, Gold Contact	F	Nickel	0.900	0.560	0.090		NONE	SOLDER	NONE		25
KC-79-07 M06		Receptacle, PCB, Silver Contact	F	Nickel	0.780	0.560	0.090		NONE	SOLDER	NONE		25
KC-79-168		Receptacle, PCB, Gold Contact	F	Silver	0.780	0.560	0.090		NONE	SOLDER	NONE		25
KC-79-07		Receptacle, PCB, Silver Contact	F	Silver	0.780	0.560	0.090		NONE	SOLDER	NONE		25
KC-79-274 M06		Receptacle, PCB, Gold Contact	F	Nickel	0.780	0.130			NONE	SOLDER	NONE		26
KC-79-237 M06		Receptacle, PCB, Angle	F	Nickel	1.340	0.990			NONE	SOLDER	NONE		27
KC-79-237 M07		Receptacle, PCB, Angle	F	Silver	1.340	0.990			NONE	SOLDER	NONE		27

**BULKHEAD RECEPTACLES**



FIGURE 28

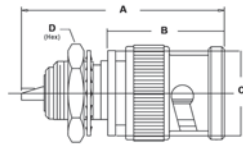


FIGURE 29



FIGURE 30

**TERMINATION**



FIGURE 31

Item Number	Military PN	Product Description	Gender	Finish	Dimensions				Cable Group	Cable Procedure	Crimp Die	Mounting Hole	Figure #
					A	B	C	D					
KC-79-44 QD		Receptacle, Front Mt	F	Nickel	0.680	0.560			NONE	SOLDER	NONE		28
KC-79-59		Receptacle, Bulkhd, Front Mt	M	Nickel	1.190	0.670	0.500	0.500	NONE	SOLDER	NONE	B	29
KC-79-58		Receptacle, Bulkhd, Front Mt	M	Silver	1.190	0.670	0.500	0.500	NONE	SOLDER	NONE	B	29
KC-79-214		Receptacle, Bulkhd, Front Mt, Iso Grnd	F	Nickel	1.080	0.530	0.630	0.560	NONE	SOLDER	NONE	A	30
KC-79-131		Receptacle, Bulkhd, Front Mt	F	Nickel	1.190	0.470	0.500	0.500	NONE	SOLDER	NONE	B	30
KC-79-35		Receptacle, Bulkhd, Front Mt	F	Nickel	1.060	0.470	0.500	0.500	NONE	SOLDER	NONE	B	30
UG-1873 /U		Receptacle, Bulkhd, Front Mt	F	Silver	1.200	0.520	0.600	0.500	NONE	SOLDER	NONE		30
KC-79-106	M39012/21-0002	Receptacle, Bulkhd, Front Mt	F	Silver	1.190	0.470	0.500	0.500	NONE	SOLDER	NONE	B	30
UG-1094 /U		Receptacle, Bulkhd, Front Mt	F	Silver	1.060	0.470	0.500	0.500	NONE	SOLDER	NONE	B	30
KC-79-200		Receptacle, Bulkhd, Front Mt	F	Nickel	0.920	0.500	0.500	0.500	NONE	SOLDER	NONE	C	30
KC-79-48		Receptacle, Bulkhd, Front Mt	F	Nickel	1.060	0.470	0.500	0.500	NONE	SOLDER	NONE	C	30
754-21-5	M39012/128-0001	Receptacle, Bulkhd, Front Mt, Iso Grnd	F	Silver	1.060	0.520	0.560	0.630	NONE	SOLDER	NONE	A	30
KC-79-302 M06		Receptacle, Bulkhd, Front Mt, Iso Grd	F	Nickel	1.380	0.630	0.500	0.500	NONE	SOLDER	NONE	B	30
KC-79-155		Receptacle, Bulkhd, Front Mt, Polarized	F	Nickel	1.250	0.500	0.060		NONE	SOLDER	NONE	B	30
KC-79-110	M39012/23-0001	Receptacle, Bulkhd, Front Mt, Angle	F	Silver	0.910	1.370	0.610	1.150	NONE	SOLDER	NONE	B	N/S
KC-79-111	M39012/23-0002	Receptacle, Bulkhd, Front Mt, Angle	F	Silver	0.910	1.240	0.610	1.020	NONE	SOLDER	NONE	D	N/S
KC-79-179		Receptacle, Bulkhd, Rear Mt	F	Nickel	1.040	0.730	0.630	0.630	NONE	SOLDER	NONE	A	N/S
KC-79-74		Receptacle, Bulkhd, Rear Mt, Hermetic	F	Nickel	1.200	0.830	0.750	0.690	NONE	SOLDER	NONE	A	N/S
KC-79-107	M39012/24-0001	Receptacle, Bulkhd, Rear Mt, Hermetic	F	Silver	1.200	0.830	0.630	0.690	NONE	SOLDER	NONE	A	N/S
KC-79-150		Receptacle, Bulkhd, Rear Mt, Iso Grnd	F	Nickel	1.060	0.730	0.560	0.560	NONE	SOLDER	NONE	A	N/S
KC-79-105	M39012/21-0001	Receptacle, Bulkhd, Front Mt	F	Silver	1.060	0.470	0.500	0.500	NONE	SOLDER	NONE	D	30
KC-79-108 M06		Receptacle, Bulkhd, Front Mt, Hermetic	F	Nickel	1.200	0.530	0.500	0.590	NONE	SOLDER	NONE	B	30
KC-79-108	M39012/24-0002	Receptacle, Bulkhd, Front Mt, Hermetic	F	Silver	1.200	0.520	0.500	0.590	NONE	SOLDER	NONE	B	30
KC-79-197		Receptacle, Bulkhd, Front Mt, Iso Grnd, Gold Contact	F	Nickel	1.060	0.530	0.560	0.630	NONE	SOLDER	NONE	A	30
KC-79-67 QD		Receptacle, Bulkhd, Front Mt, Iso Grnd, Silver Contact	F	Nickel	1.060	0.480	0.560	0.630	NONE	SOLDER	NONE	A	30
1345-3-31		Termination, 50 Ohm, 1%, 1/2 Watt, Gold Contact	M	Nickel	1.000	0.560			NONE	NONE	NONE		31
KC-89-64		Termination, 50 Ohm, 1%, 1/2 Watt, Silver Contact	M	Nickel	1.440	0.560			NONE	NONE	NONE		31
1345-4-31		Termination, 50 Ohm, 1%, 1/2 Watt, w/Chain	M	Nickel	1.000	0.560			NONE	NONE	NONE		N/S
KC-89-42		Termination, 50 Ohm, 1%, 1/2 Watt, w/Chain	M	Silver	1.520	0.560			NONE	NONE	NONE		N/S
KC-89-103		Termination, 50 Ohm, 5%, 1/2 Watt	M	Nickel	1.190	0.560			NONE	NONE	NONE		31
1340-1		Termination, 50 Ohm, 5%, 2 Watt	M-F	Nickel	1.360	0.560			NONE	NONE	NONE		N/S
KC-89-163		Termination, 50 Ohm, 5%, 2 Watt	M	Nickel	1.420	0.560			NONE	NONE	NONE		31



ADAPTERS - WITHIN SERIES



FIGURE 32

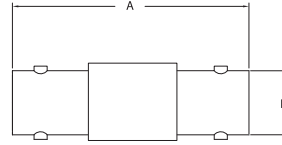


FIGURE 33

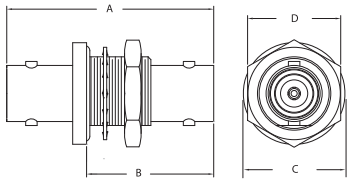


FIGURE 34

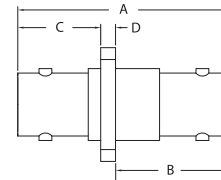


FIGURE 35

Item Number	Military PN	Product Description	Gender	Finish	Dimensions				Cable Group	Cable Procedure	Crimp Die	Mounting Hole	Figure #
					A	B	C	D					
KC-99-32		Adapter, Plug-Plug	M-M	Nickel	1.220	0.560			NONE	NONE	NONE		32
759-5	M55339/15-00491	Adapter, Plug-Plug	M-M	Silver	1.230	0.570			NONE	NONE	NONE		32
KC-99-30		Adapter, Jack-Jack	F-F	Nickel	1.280	0.440			NONE	NONE	NONE		33
759-1	M55339/16-00914	Adapter, Jack-Jack	F-F	Silver	1.280	0.440			NONE	NONE	NONE		33
KC-99-95 M06		Adapter, Bulkhd, Jack-Jack	F-F	Nickel	1.280	0.730	0.680	0.630	NONE	NONE	NONE	A	34
759-9	M55339/13-00001	Adapter, Bulkhd, Jack-Jack	F-F	Silver	1.400	0.860	0.630	0.630	NONE	NONE	NONE	A	34
KC-99-38		Adapter, Bulkhd, Hermetic, Jack-Jack	F-F	Nickel	1.530	0.860	0.690	0.750	NONE	NONE	NONE	A	34
759-2	M55339/13-00492	Adapter, Bulkhd, Hermetic, Jack-Jack	F-F	Silver	1.530	0.860	0.690	0.630	NONE	NONE	NONE	A	34
KC-99-54		Adapter, Bulkhd, Iso Grd, Jack-Jack	F-F	Nickel	1.280	0.800	0.630	0.630	NONE	NONE	NONE	A	34
KC-99-40		Adapter, Bulkhd, Iso Grd, Jack-Jack	F-F	Silver	1.280	0.800	0.630	0.630	NONE	NONE	NONE	A	34
KC-99-56		Adapter, Panel, Jack-Jack	F-F	Nickel	1.280	0.500	0.440	0.090	NONE	NONE	NONE		35

ADAPTERS - WITHIN SERIES

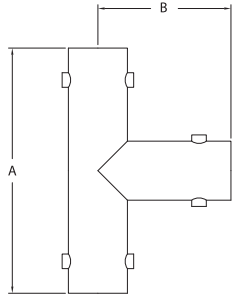


FIGURE 36

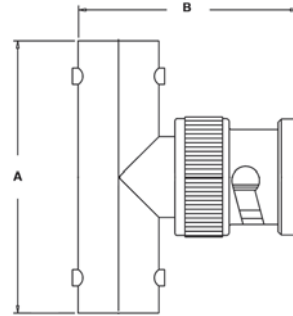


FIGURE 37

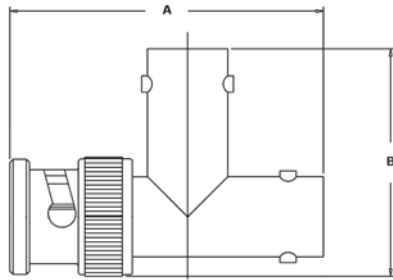


FIGURE 38

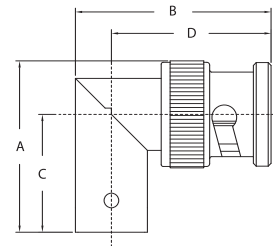


FIGURE 39

Item Number	Military PN	Product Description	Gender	Finish	Dimensions				Cable Group	Cable Procedure	Crimp Die	Mounting Hole	Figure #
					A	B	C	D					
KC-99-37		Adapter, Tee, Jack-Jack-Jack	F-F-F	Nickel	1.281	0.703			NONE	NONE	NONE		36
KC-99-20		Adapter, Tee, Jack-Jack-Jack	F-F-F	Silver	1.280	0.700			NONE	NONE	NONE		36
759-3	M55339/17-00274	Adapter, Tee, Jack-Plug-Jack	F-M-F	Silver	1.280	1.060			NONE	NONE	NONE		37
KC-99-52		Adapter, Tee, Jack-Plug-Jack, Gold Contact	F-M-F	Nickel	1.280	1.060			NONE	NONE	NONE		37
KC-99-31		Adapter, Tee, Jack-Plug-Jack, Silver Contact	F-M-F	Nickel	1.280	1.060			NONE	NONE	NONE		37
KC-99-108 M06		Adapter, Tee, Plug-Jack-Jack, Gold Contact	M-F-F	Nickel	1.480	0.980			NONE	NONE	NONE		38
KC-99-53		Adapter, Tee, Plug-Jack-Jack, Silver Contact	M-F-F	Nickel	1.480	0.980			NONE	NONE	NONE		38
KC-99-35		Adapter, Angle, Jack-Plug	F-M	Nickel	0.900	1.030	0.620	0.840	NONE	NONE	NONE		39
759-4	M55339/14-00306	Adapter, Angle, Jack-Plug	F-M	Silver	0.900	1.030	0.720	0.850	NONE	NONE	NONE		39



## SPECIFICATIONS

### MATERIAL

Body:	Brass
Crimp Sleeves:	Annealed Copper Alloy
Center Contacts:	Brass (Male) Copper Alloy (Female)
Outer Contacts:	Beryllium Copper
Insulators:	PTFE
Gaskets & Seals:	Silicone Rubber

### FINISHES

Body:	Gold
Center Contacts:	Gold

### ELECTRICAL

Impedance:	50 Ohms
Frequency Range:	DC to 18 GHz
Insulation Resistance:	5,000 Megaohms Minimum
Contact Resistance:	2.0 Milliohms Maximum
VSWR:	RG-402 1.02 + .005f (GHz) RG-405 1.02 + .008f (GHz)

- 50 Ohm Nominal Impedance.
- Blind mate design.
- Slide-on, non-locking interface allows multiple connectors to be mated simultaneously.
- Hot-mateable, can be mated while power is on.
- Designed to the interface dimensions of MIL-STD-348.
- Frequency Range: DC to 18 GHz

### MECHANICAL

Life:	500 Cycles
Insertion Force:	3.0 Pounds Maximum
Withdrawal Force:	0.5 Pounds Minimum
Center Contact Retention:	6.0 Pounds Minimum
Allowable Misalignment:	0.020" Radial, 0.060" Axial (Float Mount) 0.008" Radial, 0.015" Axial (Rigid Mount)

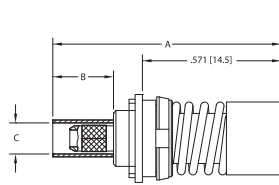
### ENVIRONMENTAL

Temperature Range:	-65° C to +125° C
Vibration:	MIL-STD-202, Method 204, Condition D
Shock:	MIL-STD-202, Method 213, Condition I
Corrosion:	MIL-STD-202, Method 101, Condition B
Moisture Resistance:	MIL-STD-202, Method 106

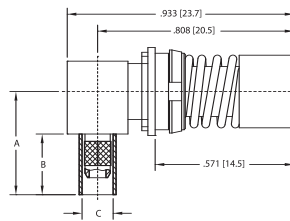
## INTERFACE DIMENSIONS



**CABLE JACKS, CRIMP TYPE - FLEXIBLE CABLE**



**FIGURE 1**



**FIGURE 2**



**FIGURE 3**

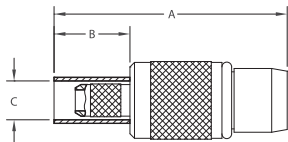


**FIGURE 4**



**FIGURE 5**

**CABLE PLUGS, CRIMP TYPE - FLEXIBLE CABLE**



**FIGURE 6**



**FIGURE 7**



**FIGURE 8**

Item Number	Military PN	Product Description	Gender	Finish	Dimensions				Cable Group	Cable Procedure	Crimp Die	Mounting Hole	Figure #
					A	B	C	T					
361-922-0630H		Jack, Floating, Crimp	F	Gold	0.940	0.250	0.128		B	CAP9-11	KTH-2011	A	1
363-922-0630H		Jack, Angle, Floating, Crimp	F	Gold	0.425	0.250	0.128		B	CAP9-12	KTH-2011	A	2
361-994-0630H		Jack, Floating, Crimp	F	Gold	0.922	0.250	0.128	0.125	B	CAP9-11	KTH-2011	F	3
361-900-0630H		Jack, Crimp	F	Gold	0.880	0.250	0.128		B	CAP9-11	KTH-2011		4
361-995-0630H		Jack, Bulkhead, Crimp	F	Gold	0.885	0.250	0.128	0.125	B	CAP9-11	KTH-2011	G	5
360-900-0630H		Plug, Crimp	M	Gold	0.768	0.250	0.128		B	CAP9-11	KTH-2011		6
360-974-0630H		Plug, Bulkhead, Crimp	M	Gold	0.762	0.250	0.128	0.125	B	CAP9-11	KTH-2011	E	7
362-974-0630H		Plug, Angle, Bulkhead, Crimp	M	Gold	0.425	0.250	0.128	0.125	B	CAP9-12	KTH-2011	E	8

## CABLE JACKS, SOLDER TYPE - SEMI-RIGID CABLE



FIGURE 9



FIGURE 10



FIGURE 11

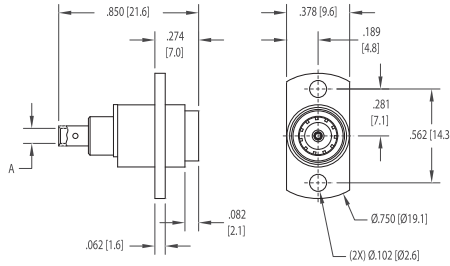


FIGURE 12

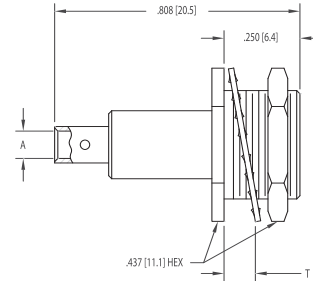


FIGURE 13

## CABLE PLUGS, SOLDER TYPE - SEMI-RIGID CABLE

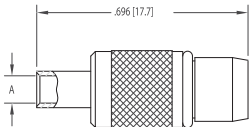


FIGURE 14

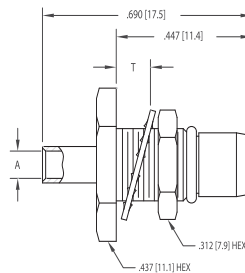


FIGURE 15

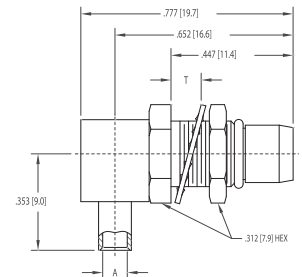


FIGURE 16

Item Number	Military PN	Product Description	Gender	Finish	Dimensions				Cable Group	Cable Procedure	Crimp Die	Mounting Hole	Figure #
					A	B	C	T					
361-500-1410H		Jack, Solder	F	Gold	0.145				49	CAP5-24			9
361-500-0850H		Jack, Solder	F	Gold	0.090				50	CAP5-24			9
361-522-1410H		Jack, Floating, Solder	F	Gold	0.145				49	CAP5-24	A		10
361-522-0850H		Jack, Floating, Solder	F	Gold	0.090				50	CAP5-24	A		10
363-522-1410H		Jack, Angle, Floating, Solder	F	Gold	0.145				49	CAP5-25	A		11
363-522-0850H		Jack, Angle, Floating, Solder	F	Gold	0.090				50	CAP5-25	A		11
361-594-1410H		Jack, Floating, Solder	F	Gold	0.145			0.125	49	CAP5-24	F		12
361-594-0850H		Jack, Floating, Solder	F	Gold	0.090			0.125	50	CAP5-24	F		12
361-595-1410H		Jack, Bulkhead, Solder	F	Gold	0.145			0.125	49	CAP5-24	G		13
361-595-0850H		Jack, Bulkhead, Solder	F	Gold	0.090			0.125	50	CAP5-24	G		13
360-500-1410H		Plug, Solder	M	Gold	0.145				49	CAP5-24			14
360-500-0850H		Plug, Solder	M	Gold	0.090				50	CAP5-24			14
360-574-1410H		Plug, Bulkhead, Solder	M	Gold	0.145			0.125	49	CAP5-24	E		15
360-574-0850H		Plug, Bulkhead, Solder	M	Gold	0.090			0.125	50	CAP5-24	E		15
362-574-1410H		Plug, Angle, Bulkhead, Solder	M	Gold	0.145			0.125	49	CAP5-25	E		16
362-574-0850H		Plug, Angle, Bulkhead, Solder	M	Gold	0.090			0.125	50	CAP5-25	E		16



**PCB PLUGS**

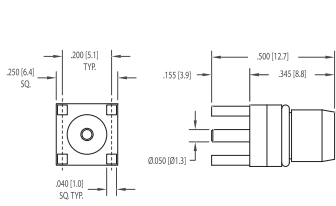


FIGURE 17

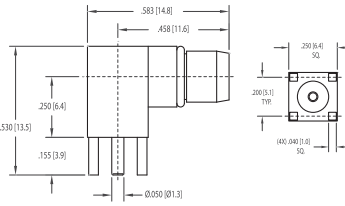


FIGURE 18

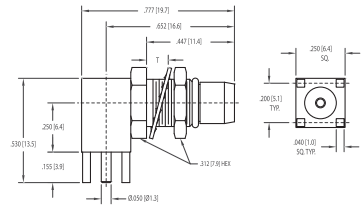


FIGURE 19

**PCB JACKS**

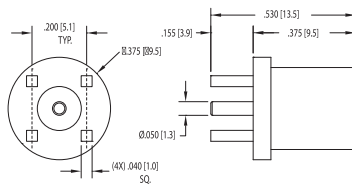


FIGURE 20

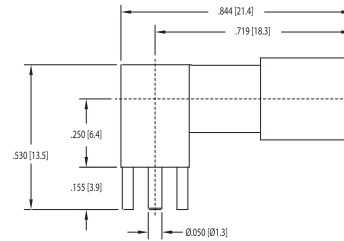


FIGURE 21

**PANEL PLUGS**

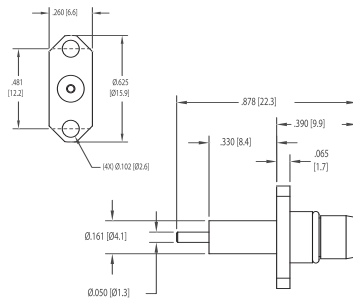


FIGURE 22\_1

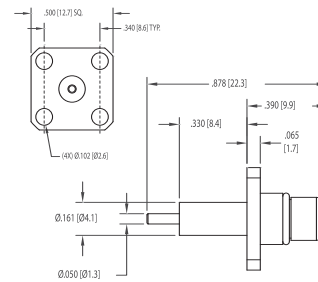


FIGURE 22\_2

**PANEL JACKS**

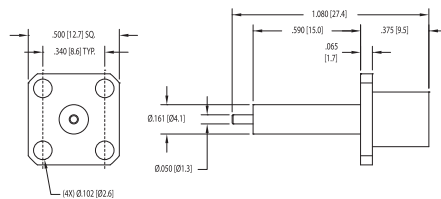


FIGURE 23\_1

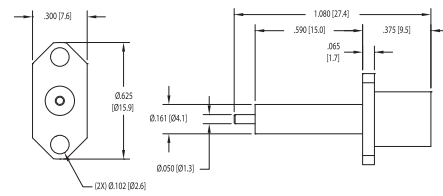
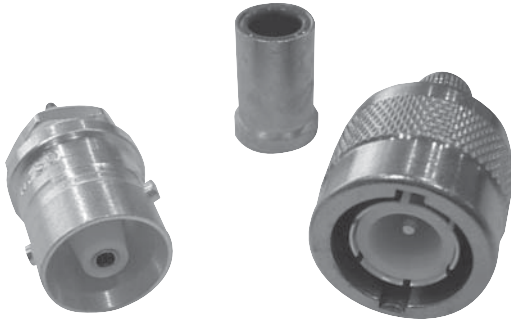


FIGURE 23\_2

Item Number	Military PN	Product Description	Gender	Finish	Dimensions				Cable Group	Cable Procedure	Crimp Die	Mounting Hole	Figure #
					A	B	C	T					
360-060-0040H		Plug, PWB	M	Gold							B	17	
362-060-0040H		Plug, Angle, PWB	M	Gold							B	18	
362-074-6040H		Plug, Angle, Bulkhead, PWB	M	Gold				0.125			B & E	19	
361-060-0040H		Jack, PWB	F	Gold							B	20	
363-060-0040H		Jack, Angle, PWB	F	Gold							B	21	
360-066-0040H		Receptacle, Panel	M	Gold							D	22_1	
360-065-0040H		Receptacle, Panel	M	Gold							C	22_2	
361-065-0040H		Receptacle, Panel	F	Gold							C	23_1	
361-066-0040H		Receptacle, Panel	F	Gold							D	23_2	

## C SERIES



### SPECIFICATIONS

#### MATERIAL

Body:	Brass
Crimp Sleeves:	Commercial Bronze Alloy
Center Contacts:	Brass (Male) Beryllium Copper (Female)
Outer Contacts:	Beryllium Copper (Male)
Insulators:	PTFE
Gaskets & Seals:	Silicone Rubber

#### FINISHES

Body:	Silver or Nickel
Center Contacts:	Gold or Silver

#### ELECTRICAL

Impedance:	50 Ohms
Frequency Range:	DC to 11 GHz
Voltage Rating:	1000 Volts RMS
VSWR:	1.35 Max, DC to 11 GHz
Insertion Loss:	.15 dB Max at 9 GHz

- 50 Ohm Nominal Impedance.
- Standard size connector with bayonet coupling.
- Durable brass bodies with Silver or Nickel plating.
- Overlapping dielectric interface with weatherproof features.
- Commercial and Military-Specified versions available.
- Frequency Range: Up to 11 GHz

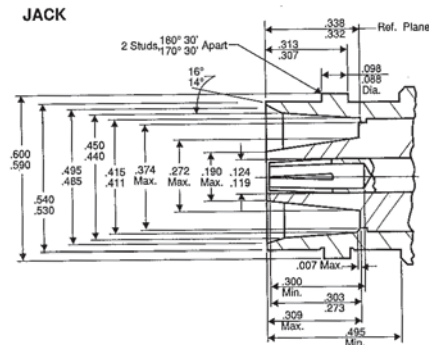
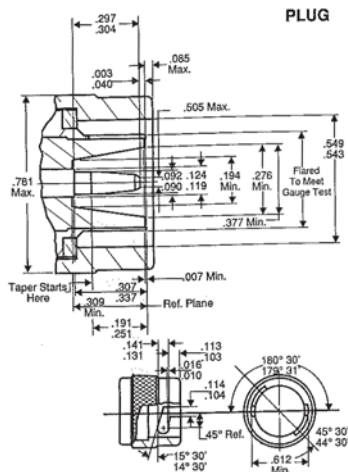
#### MECHANICAL

Life:	500 Cycles
Cable Retention:	50 Pounds Minimum

#### ENVIRONMENTAL

Temperature Range:	-65° C to +165° C
Vibration:	MIL-STD-202, Method 204, Condition B
Shock:	MIL-STD-202, Method 213, Condition I
Corrosion:	MIL-STD-202, Method 101, Condition B
Moisture Resistance:	MIL-STD-202, Method 106

### INTERFACE DIMENSIONS



ANGLE PLUG - CONVENTIONAL

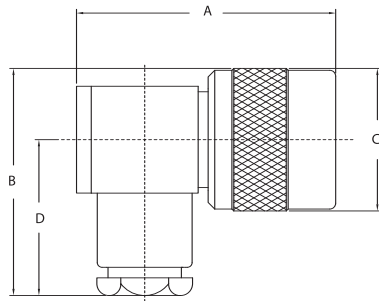


FIGURE 1

ANGLE PLUG - K-GRIP

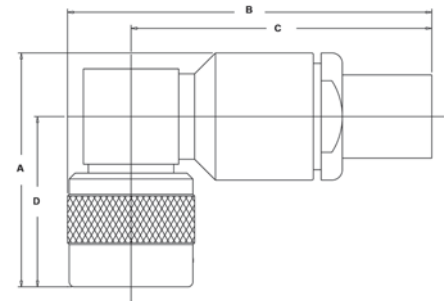


FIGURE 2

ANGLE PLUG - K-GRIP, JR.

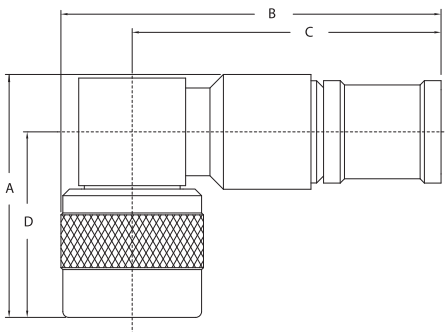


FIGURE 3

ADAPTER - WITHIN SERIES

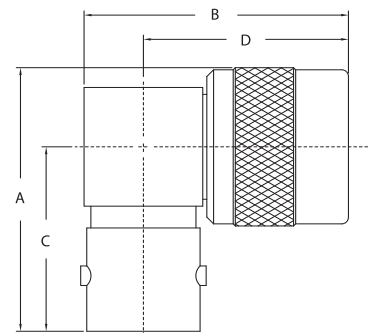


FIGURE 4

Item Number	Military PN	Product Description	Gender	Finish	Dimensions				Cable Group	Cable Procedure	Crimp Die	Mounting Hole	Figure #
					A	B	C	D					
KD-59-47		Plug, Angle, Conventional	M	Silver	1.330	1.200	0.750	0.820	DE	CP-1025			1
KD-59-84		Plug, Angle, Conventional	M	Nickel	1.350	1.620	0.750	0.970	MN	CP-1030			1
KD-59-134	M39012/10-0001	Plug, Angle, Conventional	M	Silver	1.360	1.640	0.780	1.260	N1	D-59-134-5			1
KD-59-26		Plug, Angle, Crimp	M	Silver	1.350	2.110	1.740	0.970	E1	CP-5406	KTH-2004		2
KD-59-110		Plug, Angle, Crimp, Weatherproof	M	Nickel	1.270	2.160	1.780	0.970	2	CP-5402	KTH-1079		3
KD-59-126		Plug, Angle, Crimp, Weatherproof	M	Nickel	1.300	2.080	1.720	0.970	45	CP-5406	KTH-2103		3
KD-59-187 M06		Plug, Angle, Crimp, Weatherproof	M	Nickel	1.270	1.910	1.540	0.970	12	CP-5402	KTH-2127		3
796-15-9		Plug, Angle, Crimp, Weatherproof	M	Nickel	1.300	2.090	1.710	0.970	16	3-546-2	KTH-2211		3
796-17-9		Plug, Angle, Crimp, Weatherproof	M	Nickel	1.300	2.050	1.670	0.970	17	3-546-2	KTH-2231		3
796-18-9		Plug, Angle, Crimp, Weatherproof	M	Nickel	1.300	2.150	1.770	0.970	18	3-546-2	KTH-2212		3
KD-59-110 M07		Plug, Angle, Crimp, Weatherproof	M	Silver	1.270	2.000	1.630	0.970	2	CP-5402	KTH-1079		3
796-11-9		Plug, Angle, Crimp, Weatherproof	M	Nickel	1.300	2.340	1.960	0.970	9	3-440-2	KTH-2062		3
KD-59-129		Plug, Angle, Crimp, Weatherproof	M	Nickel	1.300	2.110	1.740	0.970	D	CP-5406	KTH-2101		3
KD-59-202 M06		Plug, Angle, Crimp, Weatherproof	M	Nickel	1.300	2.110	1.740	0.970	E	CP-5406	KTH-2101		3
KD-59-193 M06		Plug, Angle, Crimp, Weatherproof	M	Nickel	1.270	2.000	1.630	0.970	N3	S-89-24-6	KTH-2105		3
799-5	M55339/10-00567	Adapter, Angle	M-F	Silver	1.250	1.270	0.880	0.970					4
798-7-9		Dust Cap	M	Nickel	0.685	0.781							N/S
KD-89-08	M39012/25-0002	Dust Cap & Safety Chain	M	Silver	0.910	0.750	3.500						N/S

PLUGS - CONVENTIONAL

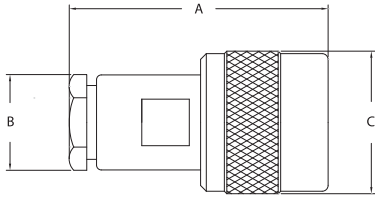


FIGURE 5

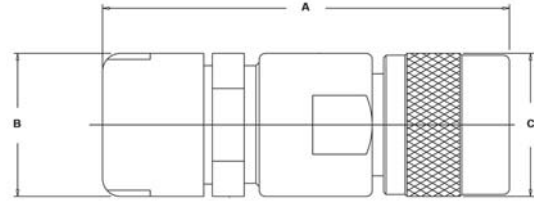


FIGURE 6

PLUGS - K-GRIP, JR.

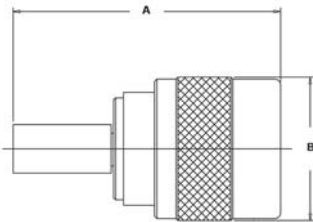


FIGURE 7

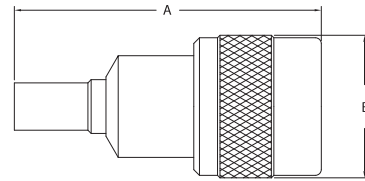


FIGURE 8

Item Number	Military PN	Product Description	Gender	Finish	Dimensions				Cable Group	Cable Procedure	Crimp Die	Mounting Hole	Figure #
					A	B	C	D					
KD-59-130	M39012/15-0002	Plug, Conventional	M	Silver	1.340	0.500	0.750		DE	CP-1015			5
KD-59-135	M39012/15-0001	Plug, Conventional	M	Silver	1.360	0.500	0.750		G1	CP-1013-3			5
KD-59-132	M39012/16-0001	Plug, Conventional	M	Silver	1.300	0.750	0.750		K1	CP-1022			5
795-10-5	M39012/06-0014	Plug, Conventional	M	Silver	1.470	0.750	0.750		K1	CP-1016			5
KD-59-119	M39012/06-0002	Plug, Conventional	M	Silver	1.470	0.750	0.750		MN	CP-1022			5
795-9-5	M39012/06-0015	Plug, Conventional	M	Silver	1.450	0.750	0.750		N1	CP-1016			5
KD-59-133	M39012/06-0003	Plug, Conventional	M	Silver	1.630	0.880	0.750		R	CP-1040			5
UG-943 B/U		Plug, Conventional	M	Silver	2.130	0.750	0.750		U	CP-1040			6
KD-59-63		Plug, Crimp	M	Silver	1.400	0.750			E1	CP-403	KTH-2001		7
KD-59-125		Plug, Crimp, Weatherproof	M	Nickel	1.630	0.750			45	CP-5406	KTH-2103		8
KD-59-186 M06		Plug, Crimp, Weatherproof	M	Nickel	1.500	0.750			12	CP-5402	KTH-2127		8
795-15-9		Plug, Crimp, Weatherproof	M	Nickel	1.615	0.781			16	3-546-2	KTH-2211		8
795-21-9		Plug, Crimp, Weatherproof	M	Nickel	1.660	0.781			17	3-546-2	KTH-2231		8
795-16-9		Plug, Crimp, Weatherproof	M	Nickel	1.400	0.781			18	3-546-2	KTH-2212		8
795-23-9		Plug, Crimp, Weatherproof	M	Nickel	1.500	0.781			18	3-546-2	KTH-2213		8
KD-59-164		Plug, Crimp, Weatherproof	M	Nickel	1.500	0.750			2	CP-5402	KTH-1079		8
795-20-9		Plug, Crimp, Weatherproof	M	Nickel	1.800	0.781			20	3-546-2	KTH-2229		8
795-13-9		Plug, Crimp, Weatherproof	M	Nickel	1.310	0.750			9	3-440-2	KTH-2062		8
KD-59-161		Plug, Crimp, Weatherproof	M	Nickel	1.660	0.750			D	CP-5406	KTH-2101		8
KD-59-201 M06		Plug, Crimp, Weatherproof	M	Nickel	1.660	0.750			E1	CP-5406	KTH-2101		8
795-30-9		Plug, Crimp, Weatherproof	M	Nickel	1.500	0.750			E1	CP-5402	KTH-2105		8
KD-59-180 M06		Plug, Crimp, Weatherproof	M	Nickel	1.500	0.750			N3	CP-5402	KTH-2105		8

**BULKHEAD JACKS - CONVENTIONAL**

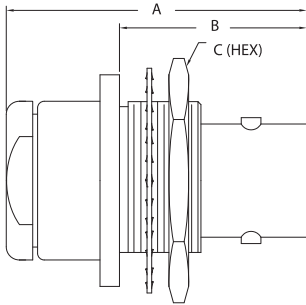


FIGURE 9

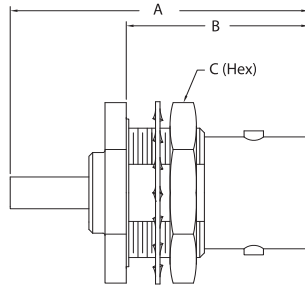


FIGURE 10

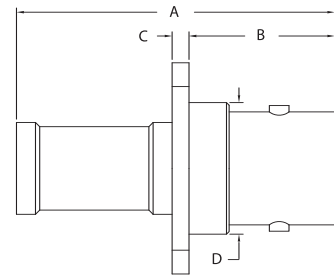


FIGURE 11

**PANEL RECEPTACLE**

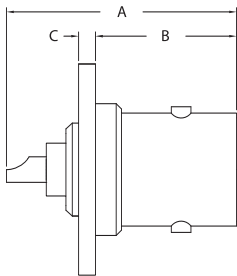


FIGURE 12

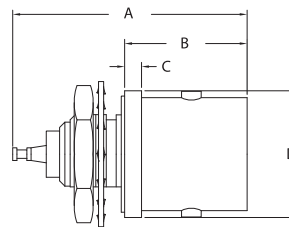


FIGURE 13

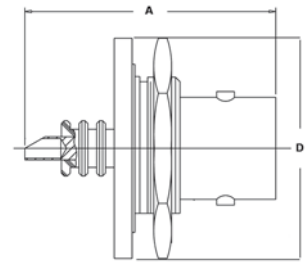


FIGURE 14

**BULKHEAD RECEPTACLES**

Item Number	Military PN	Product Description	Gender	Finish	Dimensions				Cable Group	Cable Procedure	Crimp Die	Mounting Hole	Figure #
					A	B	C	D					
KD-19-65	M39012/09-0002	Jack, Bulkhd, Conventional, Front Mt.	F	Silver	1.270	0.590			DE	704C-1	I	N/S	
KD-19-61	M39012/11-0001	Jack, Bulkhd, Conventional, Rear Mt.	F	Silver	1.420	0.890			K	573C-1	J	9	
KD-19-73	M39012/11-0002	Jack, Bulkhd, Conventional, Rear Mt.	F	Silver	1.420	0.890			MN	573C-1	I	9	
KD-19-72	M39012/08-0001	Jack, Panel, Conventional	F	Silver	1.375	0.688	0.078	0.630	MN	CP-1002		N/S	
KD-19-110		Jack, Bulkhd, Crimp, Rear Mt.	F	Silver	1.500	0.860	0.880		B2	CP-5458	KTH-2021	I	10
KD-19-93		Jack, Bulkhd, Crimp, Rear Mt.	F	Silver	1.470	0.750			D	CP-412	KTH-2001	J	10
KD-19-101		Jack, Bulkhd, Crimp, Rear Mt.	F	Silver	1.810	0.890			N	CP-480	KTH-2004	J	10
KD-19-69		Jack, Panel, Crimp, Weatherproof	F	Nickel	1.390	0.490	0.080	0.500	45	CP-5406	KTH-2103		11
KD-19-105 M06		Jack, Panel, Crimp, Weatherproof	F	Nickel	1.510	0.690	0.080	0.620	12	CP-5402	KTH-2127		11
791-9-9		Jack, Panel, Crimp, Weatherproof	F	Nickel	1.360	0.690	0.080	0.620	16	3-546-2	KTH-2211		11
791-8-9		Jack, Panel, Crimp, Weatherproof	F	Nickel	1.390	0.690	0.080	0.620	17	3-546-2	KTH-2231		11
791-6-9		Jack, Panel, Crimp, Weatherproof	F	Nickel	1.410	0.690	0.080	0.620	18	3-546-2	KTH-2212		11
KD-19-66		Jack, Panel, Crimp, Weatherproof	F	Nickel	1.510	0.690	0.080	0.620	2	CP-5402	KTH-1079		11
KD-19-68		Jack, Panel, Crimp, Weatherproof	F	Nickel	1.390	0.530	0.080	0.500	D	CP-5406	KTH-2101		11
KD-19-67		Jack, Panel, Crimp, Weatherproof	F	Nickel	1.390	0.490	0.080	0.500	E1	CP-5406	KTH-2101		11
KD-19-104 M06		Jack, Panel, Crimp, Weatherproof	F	Nickel	1.510	0.690	0.080	0.620	N3	CP-5402	KTH-2105		11
791-10-9		Jack, Panel, Crimp, Locking Thread, W/P	F	Nickel	1.410	0.690	0.080	0.620	18	3-546-2	KTH-2212		11
KD-79-19		Receptacle, Panel	F	Nickel	1.080	0.670	0.080			SOLDER			12
KD-79-14	M39012/12-0001	Receptacle, Panel	F	Silver	1.080	0.670	0.080			SOLDER			12
794-3-9		Receptacle, Bulkhd, Front Mt	F	Nickel	1.110	0.580	0.080	0.690		SOLDER		H	13
KD-79-13	M39012/13-0001	Receptacle, Bulkhd, Front Mt	F	Silver	1.110	0.580	0.800	0.600		SOLDER		H	13
794-4-9		Receptacle, Bulkhd, Rear Mt	F	Silver	1.310			1.000		SOLDER		J	14





**STRAIGHT PLUGS - K-GRIP, JR.**



FIGURE 1



FIGURE 2

**RECEPTACLES**



FIGURE 3



FIGURE 4

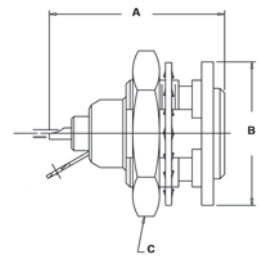


FIGURE 5

**ADAPTER - WITHIN SERIES**

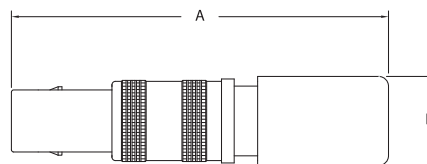


FIGURE 6

Item Number	Military PN	Product Description	Gender	Finish	Dimensions				Cable Group	Cable Procedure	Crimp Die	Mounting Hole	Figure #
					A	B	C	D					
1075-2		Plug, Crimp	M	Nickel	1.440	0.270			D	CP-458	KTH-2027		1
1075-1		Plug, Weatherproof Crimp	M	Nickel	1.370	0.270			B	CP-459	KTH-2082		2
1075-13-9		Plug, Weatherproof Crimp	M	Nickel	1.430	0.270			16	3-644-1	KTH-2232		2
1074-5		Receptacle	F	Nickel	0.610	0.310	0.040			SOLDER		K	3
1074-1 QD		Receptacle, Bulkhd, Front Mt	F	Nickel	0.610	0.310	0.340			SOLDER		L	4
1074-4		Receptacle, Bulkhd, Iso Ground	F	Nickel	0.610	0.500	0.500			SOLDER		M	5
1725-1		Termination, 50 Ohm, 1%	M	Nickel	1.190	0.280							6
1079-7		Within Series Adapter, Bulkhd	F-F	Nickel	0.820	0.400	0.340	0.040				L	N/S



- Snap-on interface.
- 1/3 smaller than the SMB connector series.
- Available in 50 and 75 Ohm versions.
- Straight, right angle, and PCB styles available.
- Durable brass bodies with Gold or Nickel plating.
- Small & lightweight.
- Frequency Range: Up to 6 GHz

## SPECIFICATIONS

### MATERIAL

Body:	Brass
Crimp Sleeves:	Annealed Copper Alloy
Center Contacts:	Brass (Male) Copper Alloy (Female)
Insulators:	PTFE

### FINISHES

Body:	Gold or Nickel
Center Contacts:	Gold

### ELECTRICAL

Impedance:	50 Ohms
Frequency Range:	DC to 6 GHz
VSWR for RG 316/U or similar:	1.30 Maximum
Insertion Loss:	0.1 dB at 1 GHz
Insulation Resistance:	1,000 Megohms Minimum
Contact Resistance:	Center Contact: 5.0 Milliohms Max Outer Contact: 1.0 Milliohms Maximum

### MECHANICAL

Life:	500 Cycles
Engagement Force:	5.6 Pounds Maximum
Disengagement Force:	1.8 Pounds Minimum 4.5 Pounds Maximum
Contact Captivation :	2.3 Pounds Minimum

### ENVIRONMENTAL

Temperature Range:	-65° C to +165° C
Vibration:	MIL-STD-202, Method 204, Condition B
Shock:	MIL-STD-202, Method 102, Condition C
Corrosion:	MIL-STD-202, Method 101, Condition B

## INTERFACE DIMENSIONS



**CABLE PLUGS, SOLDER TYPE - SEMI-RIGID CABLE**



FIGURE 1



FIGURE 2

**CABLE PLUGS, CRIMP TYPE - FLEXIBLE CABLE**



FIGURE 3

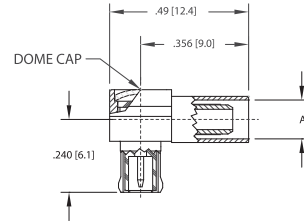


FIGURE 4

**CABLE JACK, SOLDER TYPE SEMI-RIGID CABLE**

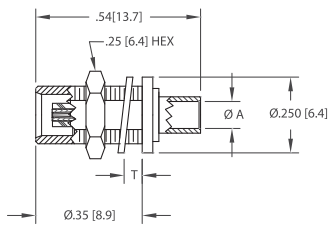


FIGURE 5

**CABLE JACK, CRIMP TYPE FLEXIBLE CABLE**



FIGURE 6

Item Number	Military PN	Product Description	Gender	Finish	Dimensions				Cable Group	Cable Procedure	Crimp Die	Mounting Hole	Figure #
					A	B	C	T					
450-500-0850H		Plug, Solder	M	Gold	0.090				48	CAP5-11			1
450-500-1410H		Plug, Solder	M	Gold	0.144				49	CAP5-11			1
450-500-0470H		Plug, Solder	M	Gold	0.052				51	CAP5-11			1
452-500-0850H		Plug, Angle, Solder	M	Gold	0.090				48	CAP5-12			2
452-500-1410H		Plug, Angle, Solder	M	Gold	0.144				49	CAP5-12			2
452-500-0470H		Plug, Angle, Solder	M	Gold	0.052				51	CAP5-12			2
450-900-0631H		Plug, Crimp	M	Gold	0.142				3	CAP9-08	KTH-2015		3
450-900-0360H		Plug, Crimp	M	Gold	0.091				A	CAP9-08	KTH-2008		3
450-900-0630H		Plug, Crimp	M	Gold	0.128				B	CAP9-08	KTH-2011		3
452-900-0631H		Plug, Angle, Crimp	M	Gold	0.142				3	CAP9-09	KTH-2015		4
452-900-0360H		Plug, Angle, Crimp	M	Gold	0.091				A	CAP9-09	KTH-2008		4
452-900-0630H		Plug, Angle, Crimp	M	Gold	0.128				B	CAP9-09	KTH-2011		4
451-580-0850H		Jack, Bulkhead, Solder	F	Gold	0.090			0.196	48	CAP5-11		P	5
451-580-1410H		Jack, Bulkhead, Solder	F	Gold	0.144			0.196	49	CAP5-11		P	5
451-580-0470H		Jack, Bulkhead, Solder	F	Gold	0.052			0.196	51	CAP5-11		P	5
451-980-0631H		Jack, Bulkhead, Crimp	F	Gold	0.142			0.196	3	CAP9-08	KTH-2015		6
451-980-0360H		Jack, Bulkhead, Crimp	F	Gold	0.091			0.196	A	CAP9-08	KTH-2008		6
451-980-0630H		Jack, Bulkhead, Crimp	F	Gold	0.128			0.196	B	CAP9-08	KTH-2011		6

\* For Nickel Plated Version, Change H to N in Part Number

## PCB PLUGS

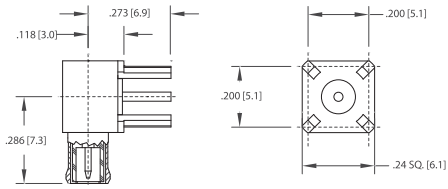


FIGURE 7



FIGURE 8

## PCB JACKS

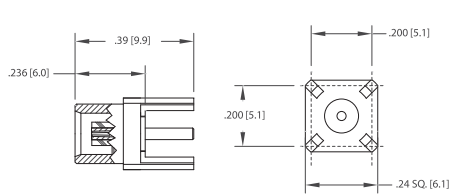


FIGURE 9



FIGURE 10\_1



FIGURE 10\_2

## SURFACEMOUNT JACKS



FIGURE 11

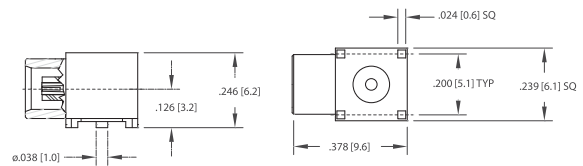


FIGURE 12

Item Number	Military PN	Product Description	Gender	Finish	Dimensions				Cable Group	Cable Procedure	Crimp Die	Mounting Hole	Figure #
					A	B	C	T					
452-060-0046H		Plug, Angle, PCB	M	Gold							0	7	
450-060-0046H		Plug, PCB	M	Gold							0	8	
451-060-0046H		Jack, PCB	F	Gold							0	9	
453-040-0046H		Jack, Angle, PCB	F	Gold							N	10_1	
453-060-0046H		Jack, Angle, PCB	F	Gold							0	10_2	
451-061-0040H		Jack, PCB, Surface Mt	F	Gold								11	
453-060-0041H		Jack, Angle, PCB, Surface Mt	F	Gold								12	



- 50 Ohm Nominal Impedance.
- Snap-on interface for quick connect & disconnect.
- 1/3 smaller than the MCX series.
- Cable, right angle, and edge card styles available.
- Frequency Range: Up to 6 GHz

**SPECIFICATIONS**

**MATERIAL**

Body:	Brass
Crimp Sleeves:	Annealed Copper Alloy
Contacts:	Copper Alloy (Female) Brass (Male)
Spring Rings:	Copper Alloy
Insulators:	PTFE

**FINISHES**

Body:	Gold or Nickel
Center Contacts:	Gold

**ENVIRONMENTAL**

Temperature Range:	-65° C to +165° C
Vibration:	MIL-STD-202, Method 204, Condition D
Shock:	MIL-STD-202, Method 102, Condition C
Corrosion:	MIL-STD-202, Method 101, Condition B

**ELECTRICAL**

Impedance:	50 Ohms
Frequency Range:	DC to 6 GHz
Contact Resistance:	Center Contact: 5.0 Milliohms Maximum Outer Contact: 2.5 Milliohms Maximum
Insulation Resistance:	1,000 Megohms Minimum

**MECHANICAL**

Life:	500 Cycles
Engagement Force:	3.4 Pounds Maximum
Disengagement Force:	1.4 Pounds Minimum
Contact Captivation:	2.3 Pounds Minimum

**INTERFACE DIMENSIONS**



## CABLE PLUGS, CRIMP TYPE - FLEXIBLE CABLE

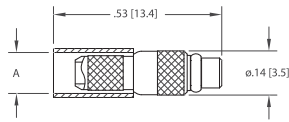


FIGURE 1

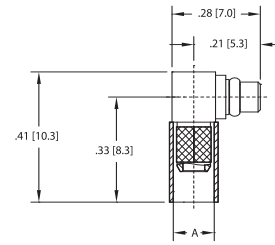


FIGURE 2

## CABLE PLUGS, SOLDER TYPE - SEMI-RIGID CABLE

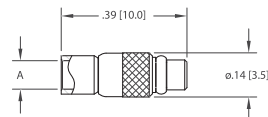


FIGURE 3

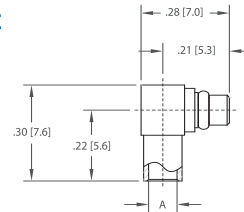


FIGURE 4

## CABLE JACK, SOLDER TYPE SEMI-RIGID CABLE



FIGURE 5

## CABLE JACK, CRIMP TYPE FLEXIBLE CABLE



FIGURE 6

Item Number	Military PN	Product Description	Gender	Finish	Dimensions				Cable Group	Cable Procedure	Crimp Die	Mounting Hole	Figure #
					A	B	C	D					
470-900-0631H		Plug, Crimp	M	Gold	0.142				3	CAP9-17	KTH-2015		1
470-900-0361H		Plug, Crimp	M	Gold	0.106				52	CAP9-17	KTH-2011		1
470-900-1000H		Plug, Crimp	M	Gold	0.128				82	CAP9-17	KTH-2011		1
470-900-0360H		Plug, Crimp	M	Gold	0.091				A	CAP9-17	KTH-2008		1
470-900-0630H		Plug, Crimp	M	Gold	0.128				B	CAP9-17	KTH-2011		1
472-900-0631H		Plug, Angle, Crimp	M	Gold	0.142				3	CAP9-18	KTH-2015		2
472-900-0361H		Plug, Angle, Crimp	M	Gold	0.106				52	CAP9-18	KTH-2011		2
472-900-1000H		Plug, Angle, Crimp	M	Gold	0.128				82	CAP9-18	KTH-2011		2
472-900-0360H		Plug, Angle, Crimp	M	Gold	0.091				A	CAP9-18	KTH-2008		2
472-900-0630H		Plug, Angle, Crimp	M	Gold	0.128				B	CAP9-18			2
471-900-0631H		Jack, Crimp	F	Gold	0.142				3	CAP9-17	KTH-2015		3
471-900-0361H		Jack, Crimp	F	Gold	0.106				52	CAP9-17	KTH-2011		3
471-900-1000H		Jack, Crimp	F	Gold	0.128				82	CAP9-17	KTH-2011		3
471-900-0360H		Jack, Crimp	F	Gold	0.091				A	CAP9-17	KTH-2008		3
471-900-0630H		Jack, Crimp	F	Gold	0.128				B	CAP9-17	KTH-2011		3
472-900-0850H		Plug, Angle, Solder	M	Gold	0.090				50	CAP5-18			4
472-900-0470H		Plug, Angle, Solder	M	Gold	0.052				51	CAP5-18			4
470-500-0850H		Plug, Solder	M	Gold	0.090				50	CAP5-17			5
470-500-0470H		Plug, Solder	M	Gold	0.052				51	CAP5-17			5
471-500-0850H		Jack, Solder	F	Gold	0.090				50	CAP5-17			6
471-500-0470H		Jack, Solder	F	Gold	0.052				51	CAP5-17			6

\* For Nickel Plated Version, Change H to N in Part Number



PCB JACKS

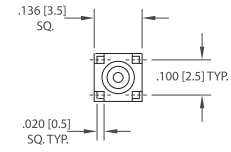
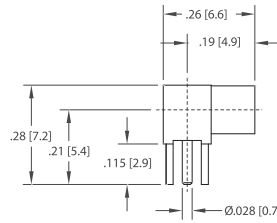
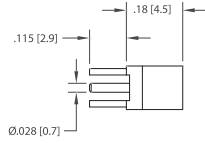
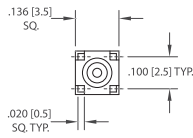


FIGURE 7

FIGURE 8

PCB PLUG

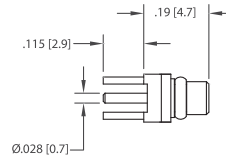
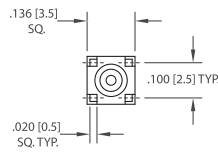


FIGURE 9

END LAUNCH JACK

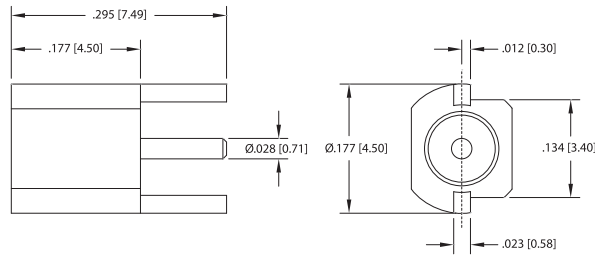
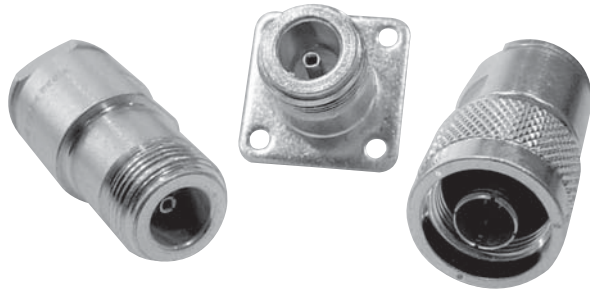


FIGURE 10

Item Number	Military PN	Product Description	Gender	Finish	Dimensions				Cable Group	Cable Procedure	Crimp Die	Mounting Hole	Figure #
					A	B	C	D					
471-040-0040H		Jack, PCB	F	Gold							Q	7	
473-040-0040H		Jack, Angle, PCB	F	Gold							Q	8	
473-040-0040N		Jack, Angle, PCB	F	Nickel							Q	8	
470-040-0040H		Plug, PCB	M	Gold							Q	9	
471-086-0040H		Jack, End Launch	F	Gold								10	
471-086-0040N		Jack, End Launch	F	Nickel								10	



## SPECIFICATIONS

### MATERIAL

Body:	Brass or Stainless Steel
Crimp Sleeves:	Commercial Bronze Alloy
Center Contacts:	Brass (Male) Beryllium Copper (Female)
Outer Contacts:	Phosphor Bronze (Male)
Insulators:	PTFE
Gaskets & Seals:	Silicone Rubber

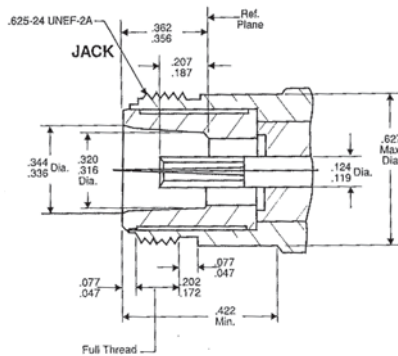
### FINISHES

Body:	Silver or Nickel
Center Contacts:	Gold

### ELECTRICAL

Impedance:	50 Ohms
Frequency Range:	DC to 11 GHz
Voltage Rating:	1000 Volts RMS
VSWR:	1.30 Max, DC to 11 GHz
Insertion Loss:	.15 dB Max at 9 GHz

## INTERFACE DIMENSIONS



- 50 Ohm Nominal Impedance.
- Threaded coupling withstands shock and vibration.
- Durable brass bodies with Silver or Nickel plating.
- Keyed versions available to prevent mismatching in critical applications.
- Commercial and Military-Specified versions available.
- Frequency Range: Up to 11 GHz

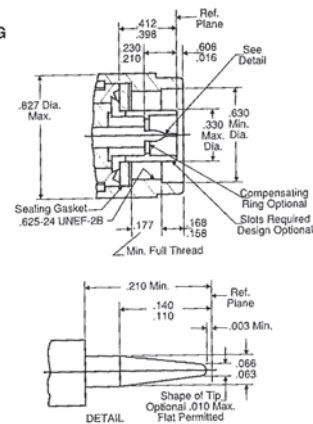
### MECHANICAL

Life:	500 Cycles
Cable Retention:	75 Pounds Minimum

### ENVIRONMENTAL

Temperature Range:	-65° C to +165° C
Vibration:	MIL-STD-202, Method 204, Condition B
Shock:	MIL-STD-202, Method 213, Condition I
Corrosion:	MIL-STD-202, Method 101, Condition B
Moisture Resistance:	MIL-STD-202, Method 106

### PLUG



JACK - CONVENTIONAL

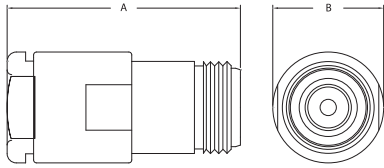


FIGURE 1

BULKHEAD JACK - K-GRIP, JR.

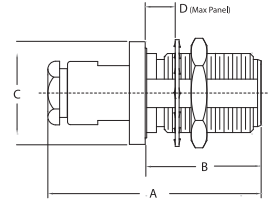


FIGURE 2

JACKS - K-GRIP, JR.

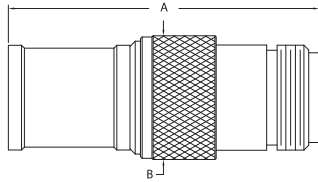


FIGURE 3

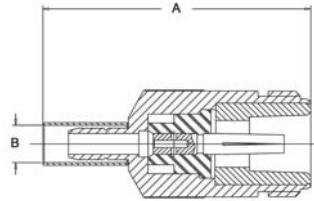


FIGURE 4

Item Number	Military PN	Product Description	Gender	Finish	Dimensions				Cable Group	Cable Procedure	Crimp Die	Mounting Hole	Figure #
					A	B	C	D					
KN-39-68	M39012/02-0003	Jack, Conventional	F		1.580	0.750			MN	CP-1016			1
UG-1186 /U		Jack, Conventional	F		1.580	0.750			MN	CP-1016			1
KN-39-102	M39012/02-0131	Jack, Conventional	F		2.310	0.750			N3	CP-1608			N/S
1203-18-5		Jack, Conventional, Bulkhd, Rear Mt.	F		2.470	0.930	0.750	0.286	22	3-260		A	N/S
UG-160 C/U		Jack, Conventional, Bulkhd, Rear Mt.	F		1.780	0.920	0.880	0.340	MN	CP-1024		A	2
1202-16-5		Jack, Conventional, Bulkhd, Rear Mt.	F		1.680	0.930	0.810	0.320	B1	3-571		A	2
KN-19-187 M07		Jack, Conventional, Bulkhd, Rear Mt.	F	Silver	1.670	0.920	0.880	0.340	B1	CP-1052		A	2
1202-15-5		Jack, Conventional, Bulkhd, Rear Mt.	F		1.680	0.930	0.500	0.320	DE	3-561		A	2
UG-556 B/U		Jack, Conventional, Bulkhd, Rear Mt.	F		1.680	0.920	0.810	0.320	DE	CP-1019		A	2
KN-19-42		Jack, Conventional, Bulkhd, Rear Mt.	F		1.430	0.920	0.880	0.340	E1	CP-1021		A	2
KN-19-114	M39012/03-0012	Jack, Conventional, Bulkhd, Rear Mt.	F		1.770	0.920	0.880	0.340	MN	CP-1016		A	2
KN-39-93		Jack, Crimp, Weatherproof	F	Nickel	1.730	0.630			2	CP-5402	KTH-1079		3
1203-13-9		Jack, Crimp, Weatherproof	F	Nickel	1.840	0.730			5	CP-5402	KTH-2177		3
KN-39-114 M06		Jack, Crimp, Weatherproof	F	Nickel	1.640	0.630			12	CP-5402	KTH-2127		3
1203-14-9		Jack, Crimp, Weatherproof	F	Nickel	1.570	0.650			16	3-546-2	KTH-2211		3
1203-19-9		Jack, Crimp, Weatherproof	F		1.600	0.650			17	3-546-2	KTH-2231		3
1203-20-9		Jack, Crimp, Weatherproof	F		1.630	0.650			18	3-546-2	KTH-2212		3
1203-16-9		Jack, Crimp, Weatherproof	F		1.730	0.650			19	3-546-2	KTH-2213		3
1203-21-9		Jack, Crimp, Weatherproof	F		1.840	0.740			20	3-546-2	KTH-2229		3
KN-39-72		Jack, Crimp, Weatherproof	F		1.580	0.630			45	CP-5406	KTH-2103		3
1203-4-9		Jack, Crimp, Weatherproof	F		1.730	0.630			N3	CP-5402	KTH-2105		3
KN-39-75		Jack, Crimp, Weatherproof	F		1.620	0.630			P	CP-444	KTH-1079		3
KN-39-86	M39012/02-0503	Jack, Crimp	F		1.580	0.630			E1	CP-489	KTH-2042		4
KN-39-52		Jack, Crimp	F		1.410	0.630			M1	CP-433	KTH-2003		4
KN-39-92		Jack, Crimp	F		1.610	0.630			M1	CP-480	KTH-2004		4
KN-39-83	M39012/02-0501	Jack, Crimp	F		1.610	0.630			N1-3	CP-480	KTH-2004		4
KN-39-97		Jack, Crimp	F		1.690	0.720				CP-480	KTH-2043		4
1203-23-9		Jack, Crimp	F		1.610	0.680			86	CP-480	KTH-2135		4
1203-24-9		Jack, Crimp	F		1.750	0.730			88	CP-480	KTH-2259		4

## PANEL JACK - CONVENTIONAL

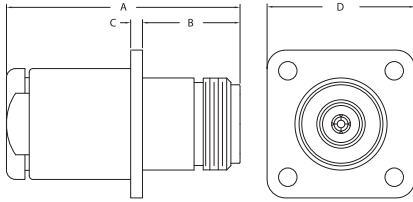


FIGURE 5

## ANGLE JACK - K-GRIP, JR.

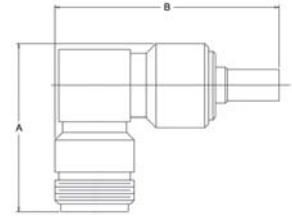


FIGURE 6

## BULKHEAD JACKS - K-GRIP, JR.

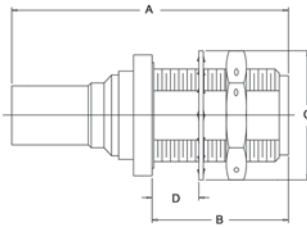


FIGURE 7

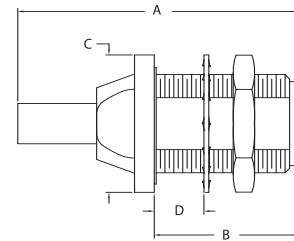


FIGURE 8

Item Number	Military PN	Product Description	Gender	Finish	Dimensions				Cable Group	Cable Procedure	Crimp Die	Mounting Hole	Figure #
					A	B	C	D					
1201-9-5	M39012/02-0006	Jack, Conventional, Panel, Panel Mt.	F		1.670	0.660	0.080	1.000	MN	3-539			5
KN-19-110	M39012/02-0006	Jack, Conventional, Panel	F		1.580	0.660	0.080	1.000	MN	3-66			5
UG-1095 B/U		Jack, Panel	F	Silver	1.420	0.660	0.080	1.000	D	CP-1015			5
1203-15-9		Jack, Crimp, Weatherproof, Angle	F		1.350	1.760			16	3-546-2	KTH-2211		6
1202-20-9		Jack, Crimp, Bulkhd, Weatherproof	F		1.850	0.920	0.880	0.324	18	3-546-2	KTH-2212	A	7
1202-26-9		Jack, Crimp, Bulkhd, Weatherproof	F		1.940	0.920	0.880	0.324	19	3-546-2	KTH-2213	A	7
1202-23-9		Jack, Crimp, Bulkhd, Weatherproof	F		2.090	0.920	0.810	0.324	20	3-546-2	KTH-2229	A	7
KN-19-151	M39012/03-0503	Jack, Crimp, Bulkhd	F		1.780	0.920	0.880	0.324	E1	CP-489	KTH-2042	A	8
KN-19-150	M39012/03-0502	Jack, Crimp, Bulkhd	F		1.820	0.920	0.880	0.324	M1	CP-480	KTH-2004	A	8
KN-19-145		Jack, Crimp, Bulkhd	F		1.820	0.920	0.880	0.250	N	CP-480	KTH-2004	A	8
KN-19-149	M39012/03-0501	Jack, Crimp, Bulkhd	F	Silver	1.820	0.920	0.880	0.125	NP	CP-480	KTH-2004	A	8
KN-19-186 M07		Jack, Crimp, Bulkhd	F	Silver	1.820	0.920	0.880	0.187	NP	CP-480	KTH-2004	A	8
KN-19-196 M06		Jack, Crimp, Bulkhd, Weatherproof	F	Nickel	1.950	0.920	0.880		N3	CP-5402	KTH-2105	A	N/S
1202-35-9		Jack, Crimp, Bulkhd	F	Nickel	1.770	0.625	0.880			3-440-2	KTH-2002	N/S	N/S
1202-25-5		Jack, Crimp, Bulkhd	F	Silver	1.900	0.920	0.900	0.324		3-597	KTH-2005	A	8
1202-21-5		Jack, Crimp, Bulkhd	F	Silver	2.090	0.920	0.880	0.324		CP-5402	KTH-2012	A	8
1202-22-5		Jack, Crimp, Bulkhd	F	Silver	2.090	0.920	0.880	0.360		CP-5402	KTH-2012	A	8
1202-2-5	M39012/03-0504	Jack, Crimp, Bulkhd	F	Silver	1.780	0.920	0.880		D	CP-489	KTH-2042	A	8

PANEL JACKS - K-GRIP, JR.

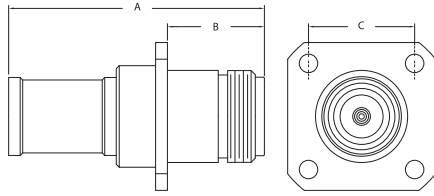


FIGURE 9

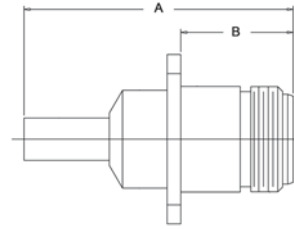


FIGURE 10

Item Number	Military PN	Product Description	Gender	Finish	Dimensions				Cable Group	Cable Procedure	Crimp Die	Mounting Hole	Figure #
					A	B	C	D					
2971-3-1		Jack, Crimp, Panel, Weatherproof	F	Nickel	1.710	0.950	0.800		1	CP-5406	KTH-2101		9
2971-3-11		Jack, Crimp, Panel, Weatherproof	F	Nickel	1.710	0.950	0.800		1	CP-5406	KTH-2101		9
2971-3-16		Jack, Crimp, Panel, Weatherproof	F	Nickel	1.710	0.950	0.800		1	CP-5406	KTH-2101		9
2971-3-6		Jack, Crimp, Panel, Weatherproof	F	Nickel	1.710	0.950	0.800		1	CP-5406	KTH-2101		9
KN-19-162		Jack, Crimp, Panel, Weatherproof	F	Nickel	1.730	0.660	0.720		2	CP-5402	KTH-1079		9
1201-6-9		Jack, Crimp, Panel, Weatherproof	F	Nickel	1.840	0.660	0.800		5	CP-5402	KTH-2177		9
KN-19-198 M06		Jack, Crimp, Panel, Weatherproof	F	Nickel	1.730	0.660	0.720		12	CP-5402	KTH-2127		9
1201-12-9		Jack, Crimp, Panel, Weatherproof	F	Nickel	1.570	0.660	0.720		16	3-546-2	KTH-2211		9
1201-22-9		Jack, Crimp, Panel, Weatherproof	F	Nickel	1.570	0.660	0.720		16	3-546-2	KTH-2211		9
2971-8-1		Jack, Crimp, Panel, Weatherproof	F	Nickel	1.700	0.945	0.720		16	3-546-2	KTH-2211		9
2971-8-11		Jack, Crimp, Panel, Weatherproof	F	Nickel	1.700	0.945	0.720		16	3-546-2	KTH-2211		9
2971-8-16		Jack, Crimp, Panel, Weatherproof	F	Nickel	1.700	0.945	0.720		16	3-546-2	KTH-2211		9
2971-8-6		Jack, Crimp, Panel, Weatherproof	F	Nickel	1.700	0.945	0.720		16	3-546-2	KTH-2211		9
1201-25-9		Jack, Crimp, Panel, Weatherproof	F	Nickel	1.600	0.660	0.720		17	3-546-2	KTH-2231		9
1201-13-9		Jack, Crimp, Panel, Weatherproof	F	Nickel	1.630	0.660	0.720		18	3-546-2	KTH-2212		9
1201-23-9		Jack, Crimp, Panel, Weatherproof	F	Nickel	1.630	0.660	0.720		18	3-546-2	KTH-2212		9
2971-7-1		Jack, Crimp, Panel, Weatherproof	F	Nickel	1.650	0.945	0.800		18	3-546-2	KTH-2212		9
2971-7-11		Jack, Crimp, Panel, Weatherproof	F	Nickel	1.650	0.945	0.800		18	3-546-2	KTH-2212		9
2971-7-16		Jack, Crimp, Panel, Weatherproof	F	Nickel	1.650	0.945	0.800		18	3-546-2	KTH-2212		9
2971-7-6		Jack, Crimp, Panel, Weatherproof	F	Nickel	1.650	0.945	0.800		18	3-546-2	KTH-2212		9
1201-14-9		Jack, Crimp, Panel, Weatherproof	F	Nickel	1.730	0.660	0.720		19	3-546-2	KTH-2213		9
1201-24-9		Jack, Crimp, Panel, Weatherproof	F	Nickel	1.730	0.660	0.720		19	3-546-2	KTH-2213		9
1201-21-9		Jack, Crimp, Panel, Weatherproof	F	Nickel	1.840	0.660	0.800		20	3-546-2	KTH-2229		9
KN-19-205 M06		Jack, Crimp, Panel, Weatherproof	F	Nickel	1.600	0.660	0.720		D	CP-5406	KTH-2101		9
KN-19-115		Jack, Crimp, Panel, Weatherproof	F	Nickel	1.580	0.660	0.720		E1	CP-5406	KTH-2101		9
KN-19-118		Jack, Crimp, Panel, Weatherproof	F	Nickel	1.600	0.660	0.720		G1	CP-5402	KTH-2062		9
KN-19-208 M06		Jack, Crimp, Panel, Weatherproof	F	Nickel	1.730	0.660	0.720		M1	CP-5402	KTH-1078		9
KN-19-195 M06		Jack, Crimp, Panel, Weatherproof	F	Nickel	1.720	0.660	0.720		N3	CP-5402	KTH-2105		9
2971-2-1		Jack, Crimp, Panel, Weatherproof	F	Nickel	1.750	0.950	0.800		N3	CP-5450	KTH-2105		9
2971-2-11		Jack, Crimp, Panel, Weatherproof	F	Nickel	1.750	0.950	0.800		N3	CP-5450	KTH-2105		9
2971-2-16		Jack, Crimp, Panel, Weatherproof	F	Nickel	1.750	0.950	0.800		N3	CP-5450	KTH-2105		9
KN-19-199 M06		Jack, Crimp, Panel, Weatherproof	F	Nickel	1.910	0.660	0.720			CP-5401	KTH-2128		9
KN-19-148	M39012/02-0513	Jack, Crimp, Panel	F	Silver	1.580	0.660	0.720		E1	CP-489	KTH-2042		10

## PLUGS

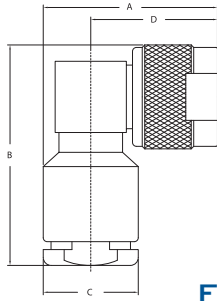


FIGURE 11

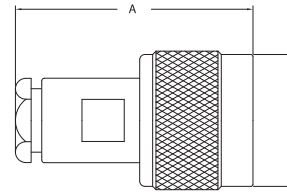


FIGURE 12

## PLUG, SOLDER TYPE - SEMI-RIGID CABLE

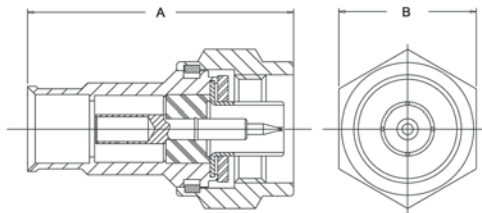


FIGURE 13

Item Number	Military PN	Product Description	Gender	Finish	Dimensions				Cable Group	Cable Procedure	Crimp Die	Mounting Hole	Figure #
					A	B	C	D					
KN-59-271		Plug, Conventional, Angle	M	Nickel	1.370	1.230	0.500	1.010	DE	CP-1025			11
1206-35-5		Plug, Conventional, Angle	M	Silver	1.380	1.720	0.750	1.010	MN	CP-1022			11
KN-59-298	M39012/05-0101	Plug, Conventional, Angle	M	Silver	1.380	1.720	0.750	1.000	MN	CP-1022			11
UG-594 B/U		Plug, Conventional, Angle	M	Silver	1.380	1.720	0.750	1.010	MN	CP-1022			11
KN-59-06		Plug, Conventional, Angle	M	Silver	1.370	1.250	0.500	1.010	DE	CP-1025			11
UG-536 B/U		Plug, Conventional	M	Silver	1.400	0.780			DE	CP-1014			12
UG-536 C/U		Plug, Conventional	M	Silver	1.410	0.780			DE	CP-1014			12
KN-59-57		Plug, Crimp	M	Silver	1.520	0.780			L	CP-213A	KTH-2004		12
KN-59-48		Plug, Crimp	M	Silver	1.500	0.790			N1	CP-230A	KTH-2004		12
KN-59-53		Plug, Crimp, Angle	M	Silver	1.380	1.660	0.750	1.010	N1	CP-211A	KTH-2004		12
UG-536 A/U		Plug, Conventional	M	Silver	1.390	0.780			DE	CP-1014			12
1205-45-5		Plug, Conventional	M	Silver	1.600	0.780			E1	3-526			12
1205-43-5		Plug, Conventional	M	Silver	1.500	0.780			Y	CP-708			12
KN-59-294	M39012/01-0101	Plug, Conventional	M	Silver	1.500	0.790			K2	CP-1016			12
1205-35-5		Plug, Conventional	M	Silver	1.630	0.780			MN	3-539			12
1205-64-3		Plug, Conventional	M		1.500	0.780			MN	CP-1016			12
KN-59-176	M39012/01-0005	Plug, Conventional	M	Silver	1.500	0.790			MN	CP-1016			12
KN-59-173		Plug, Conventional	M	Silver	1.500	0.780			MN	CP-1024			12
KN-59-226		Plug, Conventional	M	Silver	1.520	0.780			P	CP-1016			12
1205-37-5	M39012/01-0015	Plug, Conventional	M	Silver	1.875	0.780			R	3-539			12
KN-59-295	M39012/01-0104	Plug, Conventional	M	Silver	2.210	0.780			T	CP-1018			12
KN-59-296	M39012/01-0125	Plug, Conventional	M	Silver	2.110	0.780			U	CP-1608			12
1205-78-101		Plug, Direct Solder	M		1.570	0.812				3-692			13
1205-79-101		Plug, Direct Solder	M		1.570	0.812				3-692			13
KN-59-344 MAF		Plug, Conventional	M		1.820	0.780			22	3-171			N/S
1200-2-5		Plug, Angle, Antenna	M		1.370	2.790	0.860	1.150					N/S



ANGLE PLUGS - K-GRIP, JR.

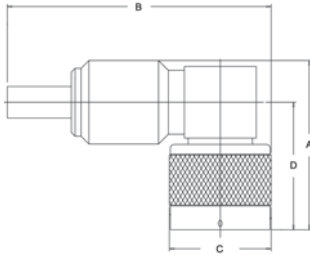


FIGURE 14

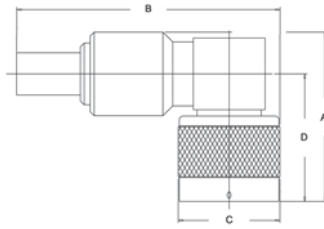


FIGURE 15

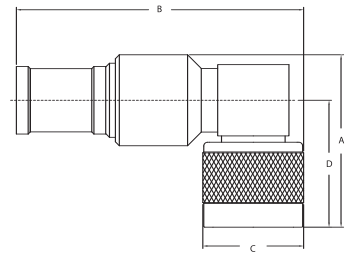


FIGURE 16

PLUGS - K-GRIP, JR.

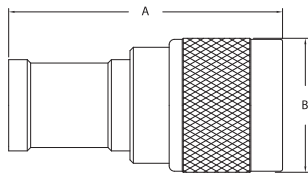


FIGURE 17

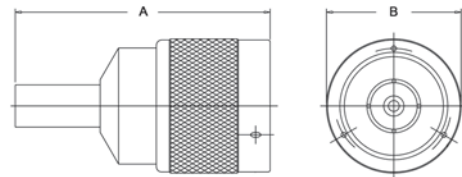


FIGURE 18

Item Number	Military PN	Product Description	Gender	Finish	Dimensions				Cable Group	Cable Procedure	Crimp Die	Mounting Hole	Figure #
					A	B	C	D					
1206-37-9		Plug, Crimp, Angle	M	Nickel	1.350	2.050	0.812	1.010	19	3-546-2	KTH-2266		14
KN-59-245	M39012/05-0503	Plug, Crimp, Angle	M	Silver	1.340	2.100	0.790	1.010	E1	CP-489	KTH-2042		14
1206-5-5	M39012/05-0504	Plug, Crimp, Angle	M	Silver	1.340	2.100	0.790	1.010	D	CP-489	KTH-2042		14
KN-59-92		Plug, Crimp, Angle	M	Silver	1.700	1.300	0.790	1.010	G1	CP-414	KTH-2002		14
KN-59-244	M39012/05-0502	Plug, Crimp, Angle	M	Silver	1.340	2.140	0.790	1.010	M1	CP-480	KTH-2004		15
KN-59-243	M39012/05-0501	Plug, Crimp, Angle	M	Silver	1.340	2.140	0.790	1.010	N1	CP-480	KTH-2004		15
KN-59-264		Plug, Crimp, Angle, Weatherproof	M	Nickel	1.340	2.260	0.790	1.010	N3	CP-5402	KTH-2105		15
1206-31-5		Plug, Crimp, Angle	M	Silver	1.500	2.370	0.827	1.010		3-597	KTH-2005		15
KN-59-263		Plug, Crimp, Angle, Weatherproof	M	Nickel	1.300	2.260	0.780	1.010	2	CP-5402	KTH-1079		16
KN-59-263 M07		Plug, Crimp, Angle, Weatherproof	M	Silver	1.300	2.260	0.780	1.010	2	CP-5402	KTH-1079		16
1206-11-9		Plug, Crimp, Angle, Weatherproof	M	Nickel	1.370	2.380	0.780	1.010	5	CP-5402	KTH-2177		16
1206-16-9		Plug, Crimp, Angle, Weatherproof	M	Nickel	1.370	2.380	0.790	1.010	7	3-440-2	KTH-2180		16
KN-59-332 M06		Plug, Crimp, Angle, Weatherproof	M	Nickel	1.300	2.170	0.780	1.010	12	CP-5402	KTH-2127		16
1206-21-9		Plug, Crimp, Angle, Weatherproof	M	Nickel	1.340	2.100	0.827	1.010	16	3-546-2	KTH-2211		16
1206-29-9		Plug, Crimp, Angle, Weatherproof	M	Nickel	1.340	2.060	0.827	1.010	17	3-546-2	KTH-2231		16
1206-22-9		Plug, Crimp, Angle, Weatherproof	M	Nickel	1.340	2.180	0.827	1.010	18	3-546-2	KTH-2212		16
1206-26-9		Plug, Crimp, Angle, Weatherproof	M	Nickel	1.340	2.280	0.827	1.010	19	3-546-2	KTH-2213		16
KN-59-158		Plug, Crimp, Angle, Weatherproof	M	Nickel	1.300	1.750	0.790	1.005	D	CP-403	KTH-2061		16
1206-30-9		Plug, Crimp, Angle, Weatherproof	M	Nickel	1.370	2.380	0.827	1.010	20	3-546-2	KTH-2229		16
KN-59-313 M06		Plug, Crimp, Angle, Weatherproof	M	Nickel	1.340	2.100	0.827	1.010	E1	CP-489	KTH-2101		16
2975-5-11		Plug, Crimp, Weatherproof, Keyed	M	Nickel	2.050	0.970			19	3-546-2	KTH-2213		17
2975-5-16		Plug, Crimp, Weatherproof, Keyed	M	Nickel	2.050	0.970			19	3-546-2	KTH-2213		17
2975-5-6		Plug, Crimp, Weatherproof, Keyed	M	Nickel	2.050	0.970			19	3-546-2	KTH-2213		17
1205-61-9		Plug, Crimp, Weatherproof	M	Nickel	1.750	0.827			20	3-546-2	KTH-2229		17
KN-59-148		Plug, Crimp, Weatherproof	M	Nickel	1.480	0.780			D	CP-415	KTH-2061		17
KN-59-183		Plug, Crimp, Weatherproof	M	Nickel	1.500	0.780			E1	CP-489	KTH-2101		17
KN-59-261		Plug, Crimp, Weatherproof	M	Nickel	1.650	0.780			M1	CP-5402	KTH-1078		17

Item Number	Military PN	Product Description	Gender	Finish	Dimensions				Cable Group	Cable Procedure	Crimp Die	Mounting Hole	Figure #
					A	B	C	D					
KN-59-329 M06		Plug, Crimp, Weatherproof	M	Nickel	1.710	0.780			N3	CP-5402	KTH-2105		17
KN-59-247		Plug, Crimp, Weatherproof	M	Nickel	1.530	0.780			D	CP-5406	KTH-2101		17
KN-59-185		Plug, Crimp, Weatherproof	M	Nickel	1.500	0.780			45	CP-5406	KTH-2103		17
2975-2-1		Plug, Crimp, Weatherproof, Keyed	M	Nickel	1.900	0.960			1	CP-489	KTH-2101		17
2975-2-11		Plug, Crimp, Weatherproof, Keyed	M	Nickel	1.900	0.960			1	CP-489	KTH-2101		17
2975-2-16		Plug, Crimp, Weatherproof, Keyed	M	Nickel	1.900	0.960			1	CP-489	KTH-2101		17
2975-2-6		Plug, Crimp, Weatherproof, Keyed	M	Nickel	1.900	0.960			1	CP-489	KTH-2101		17
KN-59-220		Plug, Crimp, Weatherproof	M	Nickel	1.650	0.780			2	CP-5402	KTH-1079		17
KN-59-220 M07		Plug, Crimp, Weatherproof	M	Silver	1.650	0.780			2	CP-5402	KTH-1079		17
1205-31-9		Plug, Crimp, Weatherproof	M	Nickel	1.750	0.780			5	CP-5402	KTH-2177		17
1205-30-9		Plug, Crimp, Weatherproof	M	Nickel	1.650	0.780			7	3-440-2	KTH-2180		17
KN-59-330 M06		Plug, Crimp, Weatherproof	M	Nickel	1.550	0.780			12	CP-5402	KTH-2127		17
1205-47-9		Plug, Crimp, Weatherproof	M	Nickel	1.500	0.827			16	3-546-2	KTH-2211		17
2975-4-1		Plug, Crimp, Weatherproof, Keyed	M	Nickel	1.900	0.970			16	3-546-2	KTH-2211		17
2975-4-11		Plug, Crimp, Weatherproof, Keyed	M	Nickel	1.900	0.970			16	3-546-2	KTH-2211		17
2975-4-16		Plug, Crimp, Weatherproof, Keyed	M	Nickel	1.900	0.970			16	3-546-2	KTH-2211		17
2975-4-6		Plug, Crimp, Weatherproof, Keyed	M	Nickel	1.900	0.970			16	3-546-2	KTH-2211		17
1205-62-7		Plug, Crimp, Weatherproof	M	Nickel	1.530	0.827			17	3-546-2	KTH-2231		17
1205-62-9		Plug, Crimp, Weatherproof	M	Nickel	1.530	0.827			17	3-546-2	KTH-2231		17
1205-48-9		Plug, Crimp, Weatherproof	M	Nickel	1.550	0.827			18	3-546-2	KTH-2212		17
2975-6-1		Plug, Crimp, Weatherproof, Keyed	M	Nickel	1.960	0.970			18	3-546-2	KTH-2212		17
2975-6-11		Plug, Crimp, Weatherproof, Keyed	M	Nickel	1.960	0.970			18	3-546-2	KTH-2212		17
2975-6-16		Plug, Crimp, Weatherproof, Keyed	M	Nickel	1.960	0.970			18	3-546-2	KTH-2212		17
2975-6-6		Plug, Crimp, Weatherproof, Keyed	M	Nickel	1.960	0.970			18	3-546-2	KTH-2212		17
1205-49-9		Plug, Crimp, Weatherproof	M	Nickel	1.650	0.827			19	3-546-2	KTH-2213		17
2975-5-1		Plug, Crimp, Weatherproof, Keyed	M	Nickel	2.050	0.970			19	3-546-2	KTH-2213		17
KN-59-160		Plug, Crimp, Weatherproof	M	Nickel	1.450	0.780				CP-460	KTH-2101		17
KN-59-361 M06		Plug, Crimp, Weatherproof	M	Nickel	1.520	0.780			G1	CP-5402	KTH-2062		17
KN-59-266		Plug, Crimp	M	Silver	1.610	0.780				CP-480	KTH-2043		N/S
KN-59-118		Plug, Crimp	M	Nickel	1.450	0.780			D	CP-415	KTH-2001		18
1205-19-5	M39012/01-0504	Plug, Crimp	M	Silver	1.500	0.780			D	CP-489	KTH-2042		18
KN-59-122		Plug, Crimp	M	Nickel	1.440	0.780			E1	CP-415	KTH-2001		18
KN-59-242	M39012/01-0503	Plug, Crimp	M	Silver	1.500	0.780			E1	CP-489	KTH-2042		18
KN-59-242 M06		Plug, Crimp	M	Nickel	1.500	0.780			E1	CP-489	KTH-2042		18
KN-59-260		Plug, Crimp	M	Silver	1.530	0.780				CP-480	KTH-2004		18
KN-59-132		Plug, Crimp	M	Nickel	1.320	0.780			M1	CP-402	KTH-2003		18
1205-68-5	M39012/01-0017	Plug, Crimp	M	Silver	2.000	0.827			M1	3-610	KTH-2004		18
KN-59-201		Plug, Crimp	M	Nickel	1.530	0.780			M1	CP-480	KTH-2004		18
KN-59-202	M39012/01-0502	Plug, Crimp	M	Silver	1.530	0.780			M1	CP-480	KTH-2004		18
KN-59-104		Plug, Crimp	M	Nickel	1.320	0.780			N1	CP-402	KTH-2004		18
KN-59-68		Plug, Crimp	M	Silver	1.320	0.780			N1	CP-402	KTH-2004		18
1205-69-5	M39012/01-0018	Plug, Crimp	M	Silver	1.530	0.780			N1	CP-480	KTH-2004		18
KN-59-239	M39012/01-0501	Plug, Crimp	M	Silver	1.530	0.780			N1	CP-480	KTH-2004		18
1205-67-9		Plug, Crimp	M	Nickel	1.500	0.780				CP-5455	KTH-2118		18
1205-4-9		Plug, Crimp	M	Nickel	1.610	0.780				CP-480	KTH-2135		18
1205-77-9		Plug, Crimp	M	Nickel	1.630	0.820			88	CP-480	KTH-2259		18
1205-65-5		Plug, Crimp	M	Silver	1.500	0.780				3-597	KTH-2005		18
1205-59-5		Plug, Crimp	M	Silver	1.828	0.827				CP-5402	KTH-2012		18

RECEPTACLES

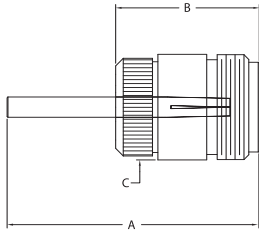


FIGURE 19

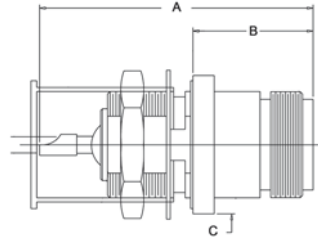


FIGURE 20

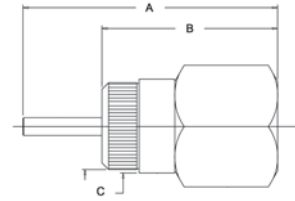


FIGURE 21

PANEL RECEPTACLES

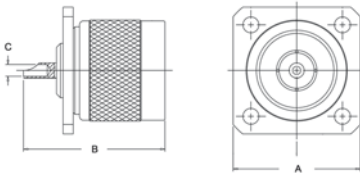


FIGURE 22

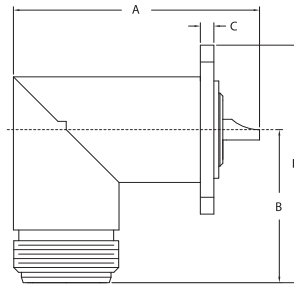


FIGURE 23

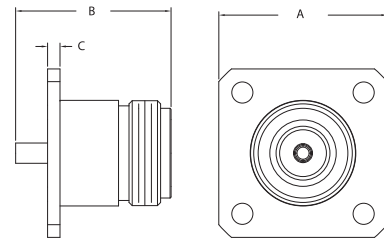


FIGURE 24

TERMINATION

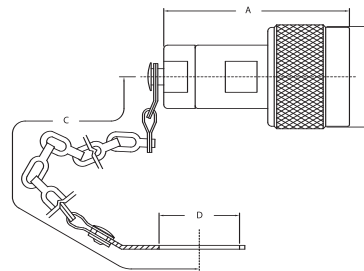


FIGURE 25

Item Number	Military PN	Product Description	Gender	Finish	Dimensions				Cable Group	Cable Procedure	Crimp Die	Mounting Hole	Figure #
					A	B	C	D					
1204-12-5		Receptacle	F	Silver	1.480	0.850	0.630					19	
1204-20-9		Receptacle	F	Nickel	1.340	0.780	0.630					19	
KN-79-69	M39012/04-0001	Receptacle	F	Silver	1.610	0.710	0.810					20	
1204-17-5		Receptacle	M		1.710	1.180	0.810					21	
KN-79-45 M06		Receptacle, Panel	M	Nickel	1.000	1.110	0.080	0.780				22	
1207-27-5		Receptacle, Panel, Angle	F	Silver	1.880	1.050	0.080	1.570				23	
UG-997 A/U		Receptacle, Panel, Angle	F	Silver	1.520	0.910	0.080	1.410				23	
1207-14-9		Receptacle, Panel	F	Nickel	1.000	0.916	0.080					24	
1207-29-9		Receptacle, Panel	F	Nickel	0.690	1.177	0.080					24	
KN-79-70	M39012/04-0002	Receptacle, Panel	F	Silver	1.000	1.130	0.080	0.630				24	
1208-10-5		Termination	M	Silver	1.590	0.780	3.750	0.640				25	
1208-28-5		Termination	M	Silver	1.590	0.780	8.000	0.640				25	
1385-13-9		Termination	M	Nickel	1.530	0.780	3.750	0.640				25	
1385-17-9		Termination	M	Nickel	1.530	0.780	N/A	N/A				25	

## ADAPTERS - WITHIN SERIES

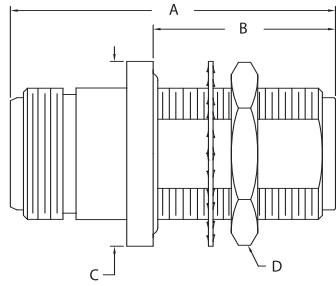


FIGURE 26

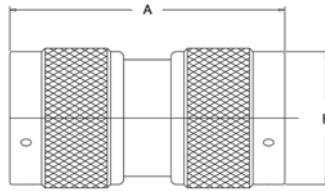


FIGURE 27

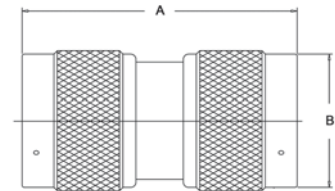


FIGURE 28

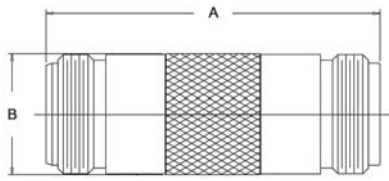


FIGURE 29

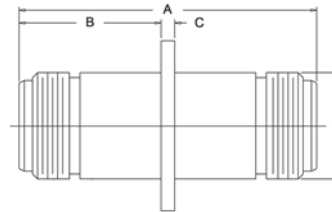


FIGURE 30

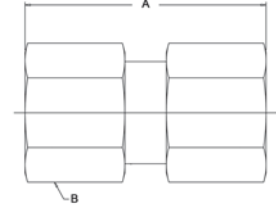


FIGURE 31

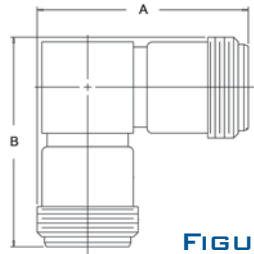


FIGURE 32

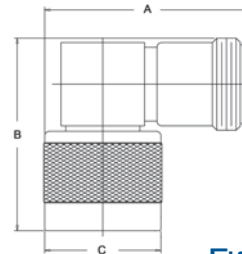


FIGURE 33

Item Number	Military PN	Product Description	Gender	Finish	Dimensions				Cable Group	Cable Procedure	Crimp Die	Mounting Hole	Figure #
					A	B	C	D					
1209-12	M55339/04-00030	Within Series Adapter	F-F	Silver	1.540	0.860	0.880	0.750				A0	26
UG-30 E/U		Within Series Adapter	F-F	Silver	1.540	0.860	0.880	0.930				A0	26
KN-99-34		Within Series Adapter	F-F	Silver	1.750	0.860	0.880	0.750				A0	26
KN-99-34 M06		Within Series Adapter	F-F	Nickel	1.750	0.860	0.880	0.750				A0	26
KN-99-58		Within Series Adapter	F-F	Nickel	1.540	0.860	0.880	0.750				A0	26
1209-19	M55339/04-00001	Within Series Adapter	F-F	Silver	1.540	0.860	0.880	0.750				A0	26
1209-9	M55339/05-00057	Within Series Adapter	M-M	Silver	1.620	0.790							27
KN-99-44		Within Series Adapter	M-M	Nickel	1.600	0.780							27
UG-57 B/U		Within Series Adapter	M-M	Silver	1.600	0.780							28
KN-99-50		Within Series Adapter	F-F	Nickel	1.750	0.630							29
1209-13	M55339/07-00029	Within Series Adapter	F-F	Silver	1.750	0.630							29
1209-44-5		Within Series Adapter	F-F	Silver	1.750	0.810	0.080	0.630					30
KN-99-102 M06		Within Series Adapter	F-F	Nickel	1.750	0.810	0.080	0.630					30
KN-99-14		Within Series Adapter	F-F	Silver	1.750	0.810	0.080	0.630					30
1209-74-22		Within Series Adapter	M-M		1.620	0.810							31
KN-99-30		Within Series Adapter	F-F	Silver	1.300	1.300							32
1209-10	M55339/03-00027	Within Series Adapter	M-F	Silver	1.370	1.320	0.780						33
UG-27 C/U		Within Series Adapter	M-F	Silver	1.370	1.320	0.780						33
UG-27 D/U		Within Series Adapter	M-F	Silver	1.370	1.320	0.780						33

ACCESSORIES

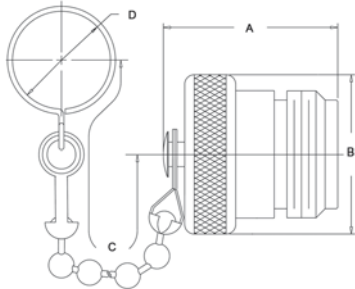


FIGURE 34

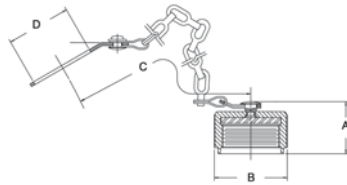


FIGURE 35

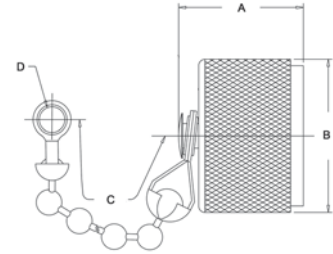


FIGURE 36

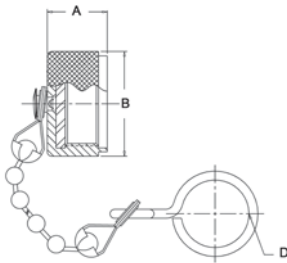


FIGURE 37

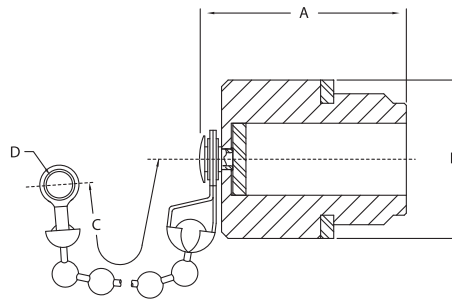


FIGURE 38

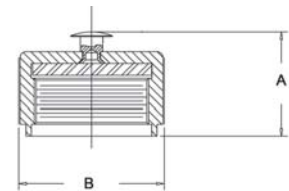


FIGURE 39

Item Number	Military PN	Product Description	Gender	Finish	Dimensions				Cable Group	Cable Procedure	Crimp Die	Mounting Hole	Figure #
					A	B	C	D					
KN-89-12		Dust Cap & Chain	F		0.840	0.780	4.500	0.480					34
KN-89-13		Dust Cap	F		0.812	0.781							N/S
1208-45-5		Dust Cap & Chain	M		0.550	0.750	3.750	0.675					35
KN-89-31	M39012/25-0012	Dust Cap & Chain	M		0.550	0.750	3.750	0.640					35
KN-89-14		Dust Cap & Chain	M		0.550	0.750	5.000	0.140					36
KN-89-30	M39012/25-0011	Dust Cap & Chain	M		0.550	0.750	2.500	0.140					36
KN-89-87 M07		Dust Cap & Chain	M	Silver	0.430	0.750	5.000	0.480					37
KN-89-05		Dust Cap & Chain	F		0.950	0.750	4.380	0.140					38
1208-46-5		Dust Cap	M		0.550	0.750							39



- 50 Ohm Nominal Impedance.
- Push/Pull connection system allows for quicker mating.
- When mated, the connectors can rotate 360 degrees.
- Mates with standard N Series jacks with a thread length of .1879 +/- .0159.
- Frequency Range: Up to 11 GHz

**SPECIFICATIONS**

**MATERIAL**

Body:	Brass
Crimp Sleeves:	Copper Alloy
Center Contacts:	Brass (Male) Copper Alloy (Female)
Outer Contacts:	Copper Alloy
Insulators:	PTFE

**FINISHES**

Body:	TriMetal
Center Contacts:	Gold

**ELECTRICAL**

Impedance:	50 Ohms
Frequency Range:	DC to 11 GHz
Voltage Rating:	1000 Volts RMS
VSWR:	1.20 Maximum
Return Loss:	-20.8 dB Minimum
Insulation Resistance:	5,000 Megohms Minimum
Contact Resistance:	Center Contact: 3.0 Milliohms Maximum Outer Contact: 3.0 Milliohms Maximum

**MECHANICAL**

Life:	500 Cycles
Mating Force:	20 Pounds Maximum
Unmating Force:	20 Pounds Maximum
Connector Retention:	50 Pounds Minimum

**ENVIRONMENTAL**

Temperature Range:	-65° C to +165° C
Vibration:	MIL-STD-202, Method 204, Condition B
Shock:	MIL-STD-202, Method 213, Condition I
Thermal Shock:	MIL-STD-202, Method 107, Condition B
Corrosion:	MIL-STD-202, Method 101, Condition B
Moisture Resistance:	MIL-STD-202, Method 106

**CABLE PLUG, CRIMP TYPE - FLEXIBLE CABLE**

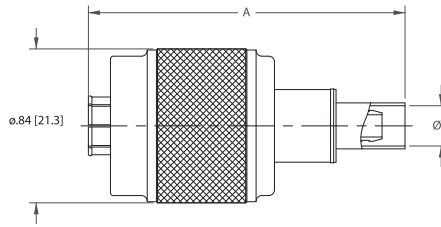


FIGURE 1

**ADAPTERS**

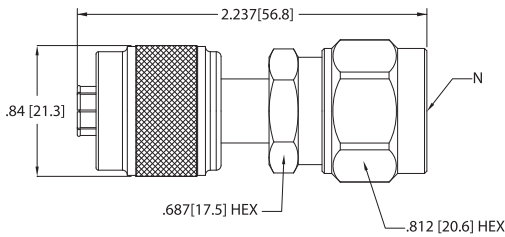


FIGURE 2

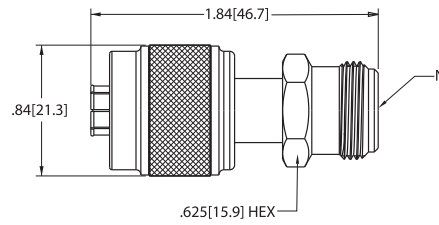


FIGURE 3

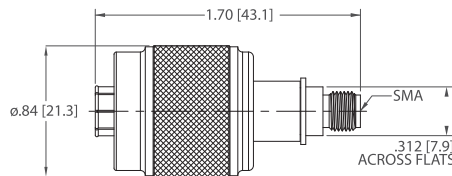


FIGURE 4

Item Number	Military PN	Product Description	Gender	Finish	Dimensions				Cable Group	Cable Procedure	Crimp Die	Mounting Hole	Figure #
					A	B	C	D					
120-900-2000R		Plug, Crimp	M	Trimetal	1.947	0.206			84		KTH-2001		1
120-900-2400R		Plug, Crimp	M	Trimetal	1.947	0.262			89		KTH-2002		1
120-900-1160R		Plug, Crimp	M	Trimetal	1.720	0.206			D		KTH-2001		1
120-900-1161R		Plug, Crimp	M	Trimetal	1.720	0.219			E		KTH-2001		1
120-600-0000R		Adapter, QC-N (M) to N (M)	M-M	Trimetal									2
120-601-0000R		Adapter, QC-N (M) to N (F)	M-F	Trimetal									3
120-351-000R		Adapter, QC-N (M) to SMA (F)	M-F	Trimetal									4



## SC SERIES



- 50 Ohm Nominal Impedance.
- Threaded version of the C Series connector.
- Durable and weatherproof—ideal for harsh environments.
- Keyed versions available to prevent mismatching and misalignment in critical applications.
- Frequency Range: Up to 11 GHz

### SPECIFICATIONS

#### MATERIAL

Body:	Brass
Crimp Sleeves:	Commercial Bronze Alloy
Center Contacts:	Brass (Male) Beryllium Copper (Female)
Outer Contacts:	Beryllium Copper (Male)
Insulators:	PTFE
Gaskets & Seals:	Silicone Rubber

#### FINISHES

Body:	Silver or Nickel
Center Contacts:	Gold or Silver

#### MECHANICAL

Life:	500 Cycles
Cable Retention:	50 Pounds Minimum

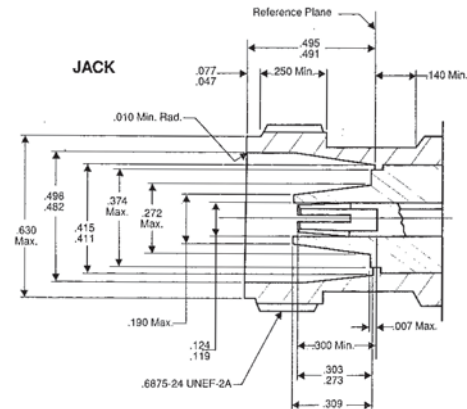
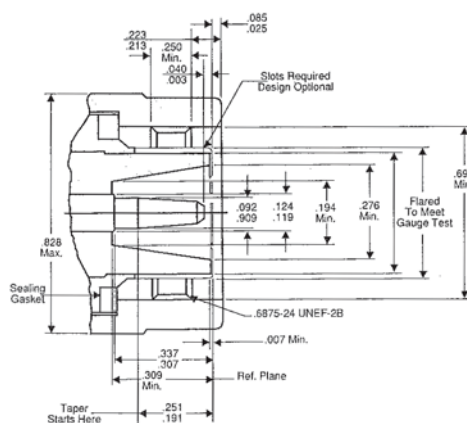
#### ELECTRICAL

Impedance:	50 Ohms
Frequency Range:	DC to 11 GHz
Voltage Rating:	1000 Volts RMS
VSWR:	1.30 Max, DC to 11 GHz
Insertion Loss:	.15 dB Max at 9 GHz

#### ENVIRONMENTAL

Temperature Range:	-65° C to +165° C
Vibration:	MIL-STD-202, Method 204, Condition B
Shock:	MIL-STD-202, Method 213, Condition I
Corrosion:	MIL-STD-202, Method 101, Condition B
Moisture Resistance:	MIL-STD-202, Method 106

### INTERFACE DIMENSIONS



**PLUG - K-GRIP, JR.**

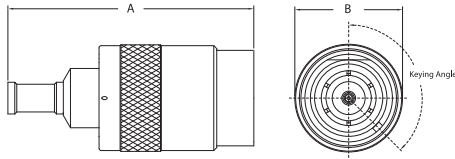


FIGURE 1

**JACK - K-GRIP, JR.**

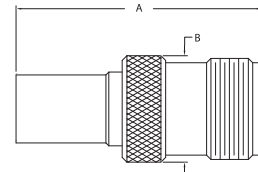


FIGURE 2

**ANGLE PLUG - K-GRIP, JR.**

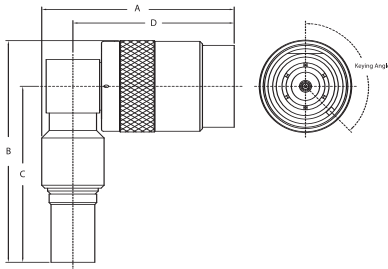


FIGURE 3

**PANEL JACK - K-GRIP, JR.**

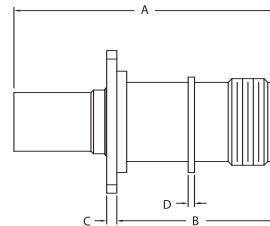
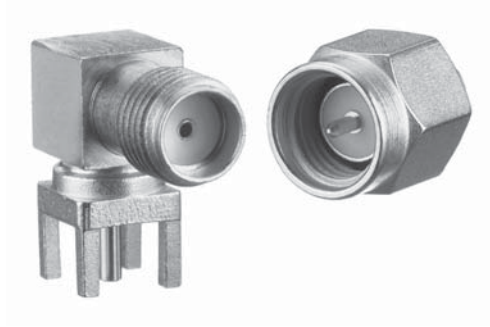


FIGURE 4

Item Number	Military PN	Product Description	Gender	Finish	Dimensions				Cable Group	Cable Procedure	Crimp Die	Mounting Hole	Figure #
					A	B	C	D					
825-10-9		Plug, Crimp	M	Nickel	1.620	0.828			16	3-546-2	KTH-2211		1
825-11-9		Plug, Crimp	M	Nickel	1.695	0.828			18	3-546-2	KTH-2212		1
825-12-9		Plug, Crimp	M	Nickel	1.790	0.828			19	3-546-2	KTH-2213		1
825-14-9		Plug, Crimp	M	Nickel	1.790	0.828			20	3-546-2	KTH-2229		1
KG-59-34 M06		Plug, Crimp	M	Nickel	1.720	0.780			N3	CP-5402	KTH-2105		1
2985-2-1		Plug, Crimp, Keyed 42°	M	Nickel	2.180	0.960			1	CP-489	KTH-2101		1
2985-2-11		Plug, Crimp, Keyed 162°	M	Nickel	2.180	0.960			1	CP-489	KTH-2101		1
2985-2-16		Plug, Crimp, Keyed 222°	M	Nickel	2.180	0.960			1	CP-489	KTH-2101		1
2985-2-6		Plug, Crimp, Keyed 102°	M	Nickel	2.180	0.960			1	CP-489	KTH-2101		1
2985-3-1		Plug, Crimp, Keyed 42°	M	Nickel	2.180	0.980			16	3-546-2	KTH-2211		1
2985-3-11		Plug, Crimp, Keyed 162°	M	Nickel	2.180	0.980			16	3-546-2	KTH-2211		1
2985-3-16		Plug, Crimp, Keyed 222°	M	Nickel	2.180	0.980			16	3-546-2	KTH-2211		1
2985-3-6		Plug, Crimp, Keyed 102°	M	Nickel	2.180	0.980			16	3-546-2	KTH-2211		1
2985-6-1		Plug, Crimp, Keyed 42°	M	Nickel	2.480	0.970			20	3-546-2	KTH-2229		1
2985-6-11		Plug, Crimp, Keyed 162°	M	Nickel	2.480	0.970			20	3-546-2	KTH-2229		1
2985-6-16		Plug, Crimp, Keyed 222°	M	Nickel	2.480	0.970			20	3-546-2	KTH-2229		1
2985-6-6		Plug, Crimp, Keyed 102°	M	Nickel	2.480	0.970			20	3-546-2	KTH-2229		1
2985-7-1		Plug, Crimp, Keyed 42°	M	Nickel	2.290	0.960			17	3-546-2	KTH-2231		1
2985-7-11		Plug, Crimp, Keyed 162°	M	Nickel	2.290	0.960			17	3-546-2	KTH-2231		1
2985-7-16		Plug, Crimp, Keyed 222°	M	Nickel	2.290	0.960			17	3-546-2	KTH-2231		1
2985-7-6		Plug, Crimp, Keyed 102°	M	Nickel	2.290	0.960			17	3-546-2	KTH-2231		1
823-2-9		Jack, Crimp	F	Nickel	1.670	0.730			19	3-546-2	KTH-2213		2
KG-81-02		Dust Cap & Chain	F	Silver	1.060	0.750	3.500	0.144					N/S

Item Number	Military PN	Product Description	Gender	Finish	Dimensions				Cable Group	Cable Procedure	Crimp Die	Mounting Hole	Figure #
					A	B	C	D					
826-10-9		Plug, Crimp, Angle	M	Nickel	1.470	2.250	1.861	1.140	19	3-546-2	KTH-2213		3
826-12-9		Plug, Crimp, Angle	M	Nickel	1.500	2.300	1.850	1.200	20	3-546-2	KTH-2229		3
826-8-9		Plug, Crimp, Angle	M	Nickel	1.470	2.090	1.710	1.140	16	3-546-2	KTH-2211		3
826-9-9		Plug, Crimp, Angle	M	Nickel	1.470	2.150	1.710	1.140	18	3-546-2	KTH-2212		3
2986-1-16		Plug, Crimp, Angle, Keyed 222°	M	Nickel	2.060	2.470	1.990	1.700	5	CP-5402	KTH-2177		3
2986-1-6		Plug, Crimp, Angle, Keyed 102°	M	Nickel	2.060	2.470	1.990	1.700	5	CP-5402	KTH-2177		3
2986-3-1		Plug, Crimp, Angle, Keyed 42°	M	Nickel	2.030	2.340	1.860	1.700	19	3-546-2	KTH-2213		3
2986-3-11		Plug, Crimp, Angle, Keyed 162°	M	Nickel	2.030	2.340	1.860	1.700	19	3-546-2	KTH-2213		3
2986-3-16		Plug, Crimp, Angle, Keyed 222°	M	Nickel	2.030	2.340	1.860	1.700	19	3-546-2	KTH-2213		3
2986-3-6		Plug, Crimp, Angle, Keyed 102°	M	Nickel	2.030	2.340	1.860	1.700	19	3-546-2	KTH-2213		3
2986-4-1		Plug, Crimp, Angle, Keyed 42°	M	Nickel	2.100	2.310	1.860	1.700	20	3-546-2	KTH-2229		3
2986-4-11		Plug, Crimp, Angle, Keyed 162°	M	Nickel	2.100	2.310	1.860	1.700	20	3-546-2	KTH-2229		3
2986-4-16		Plug, Crimp, Angle, Keyed 222°	M	Nickel	2.100	2.310	1.860	1.700	20	3-546-2	KTH-2229		3
2986-4-6		Plug, Crimp, Angle, Keyed 102°	M	Nickel	2.100	2.310	1.860	1.700	20	3-546-2	KTH-2229		3
821-2-9		Jack, Panel	F	Nickel	1.550	0.650	0.800	N/A	E1	CP-5406	KTH-2102		4
821-3-9		Jack, Panel	F	Nickel	1.740	0.840	0.690	N/A	5	CP-5402	KTH-2177		4
821-4-9		Jack, Panel	F	Nickel	1.570	0.846	0.685	N/A	18	3-546-2	KTH-2212		4
821-5-9		Jack, Panel	F	Nickel	1.670	0.846	0.685	N/A	19	3-546-2	KTH-2213		4
821-6-9		Jack, Panel	F	Nickel	1.740	0.845	0.685	N/A	20	3-546-2	KTH-2229		4
821-7-9		Jack, Panel	F	Nickel	1.520	0.790	0.685	N/A	16	3-546-2	KTH-2211		4
2981-1-1		Jack, Panel, Keyed 42°	F	Nickel	2.110	1.250	0.080	0.050	5	CP-5402	KTH-2177		4
2981-1-11		Jack, Panel, Keyed 162°	F	Nickel	2.110	1.250	0.080	0.050	5	CP-5402	KTH-2177		4
2981-11-1		Jack, Panel, Keyed 42°	F	Nickel	2.150	1.250	0.080	0.050	20	3-546-2	KTH-2229		4
2981-11-11		Jack, Panel, Keyed 162°	F	Nickel	2.150	1.250	0.080	0.050	20	3-546-2	KTH-2229		4
2981-11-16		Jack, Panel, Keyed 222°	F	Nickel	2.150	1.250	0.080	0.050	20	3-546-2	KTH-2229		4
2981-1-16		Jack, Panel, Keyed 222°	F	Nickel	2.110	1.250	0.080	0.050	5	CP-5402	KTH-2177		4
2981-11-6		Jack, Panel, Keyed 102°	F	Nickel	2.150	1.250	0.080	0.050	20	3-546-2	KTH-2229		4
2981-1-6		Jack, Panel, Keyed 102°	F	Nickel	2.110	1.250	0.080	0.050	5	CP-5402	KTH-2177		4
2981-3-1		Jack, Panel, Keyed 42°	F	Nickel	2.010	1.250	0.080	0.050	1	CP-5402	KTH-2101		4
2981-3-11		Jack, Panel, Keyed 162°	F	Nickel	2.010	1.250	0.080	0.050	1	CP-5402	KTH-2101		4
2981-3-16		Jack, Panel, Keyed 222°	F	Nickel	2.010	1.250	0.080	0.050	1	CP-5402	KTH-2101		4
2981-3-6		Jack, Panel, Keyed 102°	F	Nickel	2.010	1.250	0.080	0.050	1	CP-5402	KTH-2101		4
2981-5-1		Jack, Panel, Keyed 42°	F	Nickel	2.065	1.250	0.080	0.050	19	3-546-2	KTH-2213		4
2981-5-11		Jack, Panel, Keyed 162°	F	Nickel	2.065	1.250	0.080	0.050	19	3-546-2	KTH-2213		4
2981-5-16		Jack, Panel, Keyed 222°	F	Nickel	2.065	1.250	0.080	0.050	19	3-546-2	KTH-2213		4
2981-5-6		Jack, Panel, Keyed 102°	F	Nickel	2.065	1.250	0.080	0.050	19	3-546-2	KTH-2213		4
2981-7-1		Jack, Panel, Keyed 42°	F	Nickel	2.065	1.250	0.080	0.050	19	3-546-2	KTH-2213		4
2981-7-11		Jack, Panel, Keyed 162°	F	Nickel	2.065	1.250	0.080	0.050	19	3-546-2	KTH-2213		4
2981-7-16		Jack, Panel, Keyed 222°	F	Nickel	2.065	1.250	0.080	0.050	19	3-546-2	KTH-2213		4
2981-7-6		Jack, Panel, Keyed 102°	F	Nickel	2.065	1.250	0.080	0.050	19	3-546-2	KTH-2213		4
2981-8-1		Jack, Panel, Keyed 42°	F	Nickel	2.010	1.250	0.080	0.050	16	3-546-2	KTH-2211		4
2981-8-11		Jack, Panel, Keyed 162°	F	Nickel	2.010	1.250	0.080	0.050	16	3-546-2	KTH-2211		4
2981-8-16		Jack, Panel, Keyed 222°	F	Nickel	2.010	1.250	0.080	0.050	16	3-546-2	KTH-2211		4
2981-8-6		Jack, Panel, Keyed 102°	F	Nickel	2.010	1.250	0.080	0.050	16	3-546-2	KTH-2211		4



- 50 Ohm Nominal Impedance.
- Semi-precision, sub-miniature connectors with threaded interface.
- Excellent electrical performance.
- Commercial and Military-Specified versions.
- Available for semi-rigid, standard, flexible cables and receptacles.
- Frequency Range: Up to 18 GHz

## SPECIFICATIONS

### MATERIAL

Body:	Brass or Stainless Steel
Crimp Sleeves: Copper Alloy	Commercial Bronze or Copper Alloy
Center Contacts:	Brass (Male) Copper Alloy (Female)
Insulators:	PTFE
Gaskets & Seals:	Silicone Rubber

### FINISHES

Body:	Gold or Passivated
Center Contacts:	Gold

### ELECTRICAL

Impedance:	50 Ohms
Frequency Range:	DC to 18 GHz
Voltage Rating:	355 to 500 Volts RMS
VSWR:	Dependent on Cable
Insertion Loss:	Dependent on Cable

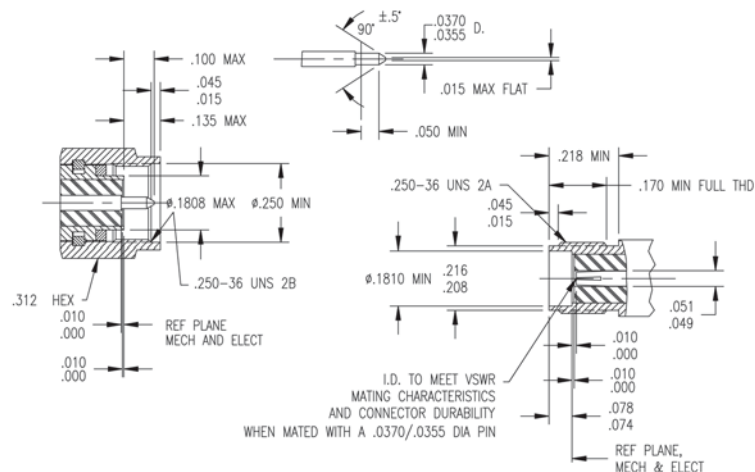
### MECHANICAL

Life:	500 Cycles
Cable Retention:	10 to 60 Pounds (Dependent on Cable)

### ENVIRONMENTAL

Temperature Range:	-65° C to +165° C -65° C to +125° C (Epoxy Connectors)
Vibration:	MIL-STD-202, Method 204, Condition D
Shock:	MIL-STD-202, Method 213, Condition I
Corrosion:	MIL-STD-202, Method 101, Condition B
Moisture Resistance:	MIL-STD-202, Method 106

## INTERFACE DIMENSIONS



# SMA SERIES

## CABLE JACKS, SOLDER TYPE - SEMI-RIGID CABLE

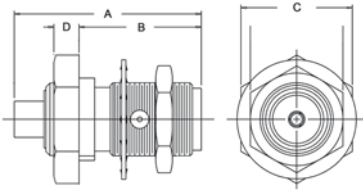


FIGURE 1

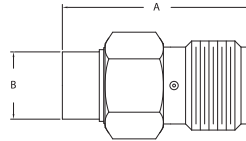


FIGURE 2

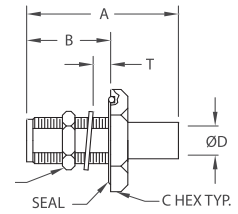


FIGURE 3

## CABLE PLUGS, SOLDER TYPE - SEMI-RIGID CABLE

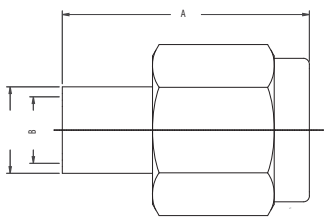


FIGURE 4

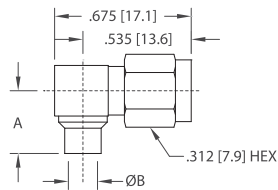


FIGURE 5

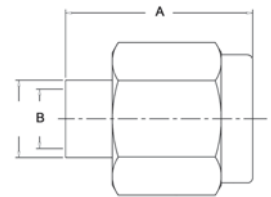


FIGURE 6

## CABLE JACKS, CLAMP TYPE - FLEXIBLE CABLE

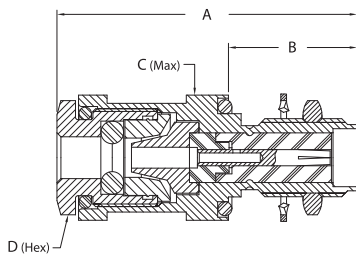


FIGURE 7

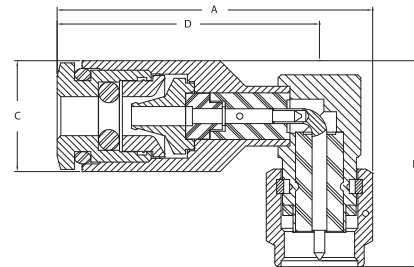
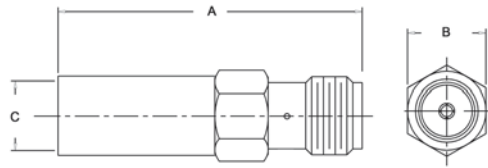


FIGURE 8

Item Number	Military PN	Product Description	Gender	Finish	Dimensions					Cable Group	Cable Procedure	Crimp Die	Mounting Hole	Figure #
					A	B	C	D	T					
872-57-3		Jack, Direct Solder, Bulkhd	F	Passivated	0.640	0.410	0.380	0.090	0.113	50	3-481		AN	1
872-37-3	M39012/83-3008	Jack, Direct Solder, Bulkhd	F	Passivated	0.640	0.410	0.440	0.144	0.250	49	3-482		AN	1
872-56-2		Jack, Direct Solder, Bulkhd	F	Gold	0.640	0.410	0.440	0.144	0.113	49	3-482		AN	1
872-36-3	M39012/83-3007	Jack, Direct Solder, Bulkhd	F	Passivated	0.640	0.410	0.440	0.090	0.113	50	CP-3800-1		AN	1
878-2-3		Dust Cap & Chain	M	Passivated	0.430	0.302	0.140	2.250						N/S
351-500-0850H		Jack, Solder	F	Gold/Brass	0.500	0.120				48	CAP5-02			2
351-500-1410H		Jack, Solder	F	Gold/Brass	0.500	0.180				49	CAP5-02			2
873-19-3	M39012/81-3008	Jack, Direct Solder	F	Passivated	0.520	0.180				49	3-482			2
251-575-0850G		Jack, Bulkhd, Solder	F	Gold	0.750	0.415	0.437	0.090	0.093	48	CAP5-02		R	3
351-575-0850H		Jack, Bulkhd, Solder	F	Gold/Brass	0.750	0.450	0.312	0.090	0.093	48	CAP5-02		R	3
251-575-1410G		Jack, Bulkhd, Solder	F	Gold	0.750	0.415	0.437	0.144	0.093	49	CAP5-02		R	3
351-575-1410H		Jack, Bulkhd, Solder	F	Gold/Brass	0.750	0.450	0.312	0.144	0.093	49	CAP5-02		R	3
872-47-3		Jack, Clamp, Bulkhd	F	Gold	0.960	0.406	0.390	0.066	0.113	3	3-515		AN	7

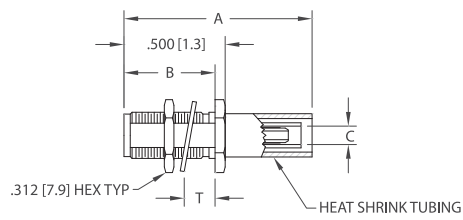
Item Number	Military PN	Product Description	Gender	Finish	Dimensions				Cable Group	Cable Procedure	Crimp Die	Mounting Hole	Figure #
					A	B	C	D					
250-500-0850G		Plug, Solder	M	Gold	0.440	0.090			48	CAP5-02			4
250-500-0853G		Plug, Solder	M	Gold	0.330	0.090			48	CAP5-02			4
250-500-0858G		Plug, Solder, Insulator Assembled	M	Gold	0.440	0.090			48	CAP5-02			4
350-500-0850H		Plug, Solder	M	Gold	0.440	0.090			48	CAP5-02			4
350-500-0858H		Plug, Solder, Insulator Assembled	M	Gold	0.440	0.090			48	CAP5-02			4
250-500-0850P		Plug, Solder	M	Passivated	0.440	0.090			48	CAP5-02			4
250-500-0853P		Plug, Solder	M	Passivated	0.330	0.090			48	CAP5-02			4
250-500-0858P		Plug, Solder, Insulator Assembled	M	Passivated	0.440	0.090			48	CAP5-02			4
250-500-1410G		Plug, Solder, w/o Center Contact	M	Gold	0.330	0.144			49	CAP5-01			4
350-500-1410H		Plug, Solder, w/o Center Contact	M	Gold	0.330	0.144			49	CAP5-01			4
250-500-1411G		Plug, Solder, w/o Center Contact	M	Gold	0.440	0.144			49	CAP5-02			4
250-500-1412G		Plug, Solder	M	Gold	0.440	0.144			49	CAP5-02			4
250-500-1413G		Plug, Solder	M	Gold	0.330	0.144			49	CAP5-02			4
250-500-1418G		Plug, Solder, Insulator Assembled	M	Gold	0.440	0.144			49	CAP5-02			4
350-500-1411H		Plug, Solder, w/o Center Contact	M	Gold	0.440	0.144			49	CAP5-02			4
350-500-1412H		Plug, Solder	M	Gold	0.440	0.144			49	CAP5-02			4
350-500-1418H		Plug, Solder, Insulator Assembled	M	Gold	0.440	0.144			49	CAP5-02			4
250-500-1410P		Plug, Solder, w/o Center Contact	M	Passivated	0.330	0.144			49	CAP5-01			4
250-500-1411P		Plug, Solder, w/o Center Contact	M	Passivated	0.440	0.144			49	CAP5-02			4
250-500-1412P		Plug, Solder	M	Passivated	0.440	0.144			49	CAP5-02			4
250-500-1413P		Plug, Solder	M	Passivated	0.330	0.144			49	CAP5-02			4
250-500-1418P		Plug, Solder, Insulator Assembled	M	Passivated	0.440	0.144			49	CAP5-02			4
875-81-17	M39012/55-3007	Plug, Conventional	M	Passivated	0.990	0.312	0.400		B1	3-559			4
875-82-17	M39012/55-3009	Plug, Conventional	M	Passivated	0.990	0.312	0.400		DE	3-519			4
875-82-3	M39012/55-3109	Plug, Conventional	M	Passivated	0.990	0.312	0.400		DE	3-519			4
875-86-3	M39012/55-3130	Plug, Conventional	M	Passivated	0.990	0.312	0.400		3	3-519			4
252-500-1410G		Plug, Angle, Solder	M	Gold	0.310	0.144			49	CAP5-03			5
352-500-1410H		Plug, Angle, Solder	M	Gold	0.310	0.144			49	CAP5-03			5
252-500-1410P		Plug, Angle, Solder	M	Passivated	0.310	0.144			49	CAP5-03			5
252-500-0850G		Plug, Angle, Solder	M	Gold	0.310	0.090			48	CAP5-03			5
352-500-0850H		Plug, Angle, Solder	M	Gold	0.310	0.090			48	CAP5-03			5
252-500-0850P		Plug, Angle, Solder	M	Passivated	0.310	0.090			48	CAP5-03			5
875-59-3		Plug, Direct Solder	M	Passivated	0.440	0.312			49	3-302			6
875-107-3		Plug, Direct Solder	M	Passivated	0.440	0.312			49	3-303			6
875-58-3		Plug, Direct Solder	M	Passivated	0.440	0.312			49	3-303			6
875-69-3	M39012/79-3107	Plug, Direct Solder	M	Passivated	0.430	0.310			50	3-481			6
875-70-17	M39012/79-3008	Plug, Direct Solder	M	Passivated	0.430	0.310			49	3-482			6
875-70-3	M39012/79-3108	Plug, Direct Solder	M	Passivated	0.430	0.310			49	3-482			6
876-62-17	M39012/56-3030	Plug, Conventional, Angle	M	Passivated	1.040	0.700	0.380	0.860	3	3-519			8
876-60-3	M39012/56-3107	Plug, Conventional, Angle	M		1.040	0.700	0.380	0.860	B1	3-559			8
876-49-3	M39012/80-3108	Plug, Direct Solder, Angle	M	Passivated	0.650	0.540	0.180	0.510	49	3-482			N/S
876-62-3	M39012/56-3130	Plug, Conventional, Angle	M	Passivated	1.040	0.700	0.380	0.860	3	3-519			8
876-61-17	M39012/56-3009	Plug, Angle, Conventional	M	Passivated	1.040	0.700	0.380	0.860	DE	3-519			8

**JACK**



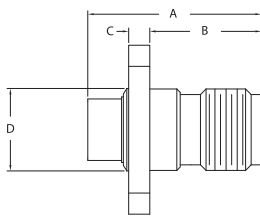
**FIGURE 9**

**BULKHEAD JACK**

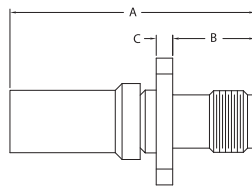


**FIGURE 10**

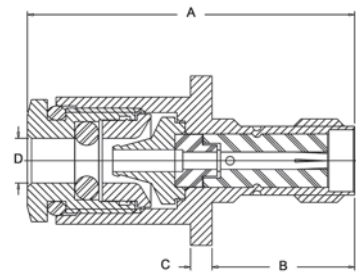
**PANEL JACKS**



**FIGURE 11**



**FIGURE 12**



**FIGURE 13**

Item Number	Military PN	Product Description	Gender	Finish	Dimensions				Cable Group	Cable Procedure	Crimp Die	Mounting Hole	Figure #
					A	B	C	D					
351-900-0631H		Jack, Crimp	F	Gold	1.125	0.142			3	CAP9-04	KTH-2015		9
351-900-0631N		Jack, Crimp	F	Nickel	1.125	0.142			3	CAP9-04	KTH-2015		9
351-900-0630H		Jack, Crimp	F	Gold	1.125	0.128			B	CAP9-04	KTH-2011		9
351-900-0630N		Jack, Crimp	F	Nickel	1.125	0.128			B	CAP9-04	KTH-2011		9
351-900-1160H		Jack, Crimp	F	Gold	1.125	0.206			D	CAP9-04	KTH-2001		9
351-900-1160N		Jack, Crimp	F	Nickel	1.125	0.206			D	CAP9-04	KTH-2001		9
873-1-3	M39012/56B3114	Jack, Crimp	F	Passivated	0.950	0.250	0.210		D	CP-432	KTH-2001		9
351-900-1161H		Jack, Crimp	F	Gold	1.125	0.219			E	CAP9-04	KTH-2001		9
351-900-1161N		Jack, Crimp	F	Nickel	1.125	0.219			E	CAP9-04	KTH-2001		9
873-3-1		Jack, Crimp	F	Gold	0.950	0.250	0.220		E	CP-432	KTH-2001		9
873-18	M39012/57-4502	Jack, Crimp	F	Gold	0.970	0.220			E1	CP-493	KTH-2113		9
873-18-3	M39012/57-3502	Jack, Crimp	F	Passivated	0.970	0.220			E2	CP-493	KTH-2113		9
251-975-0631G		Jack, Crimp, Bulkhd	F	Gold	0.875	0.450	0.142		3	CAP9-04	KTH-2015	R	10
351-975-0631H		Jack, Crimp, Bulkhd	F	Gold	0.875	0.450	0.142		3	CAP9-04	KTH-2015	R	10
351-975-0631N		Jack, Crimp, Bulkhd	F	Nickel	0.875	0.450	0.142		3	CAP9-04	KTH-2015	R	10
251-975-0631P		Jack, Crimp, Bulkhd	F	Passivated	0.875	0.450	0.142		3	CAP9-04	KTH-2015	R	10
251-975-0630G		Jack, Crimp, Bulkhd	F	Gold	0.875	0.450	0.128		B	CAP9-04	KTH-2011	R	10
351-975-0630H		Jack, Crimp, Bulkhd	F	Gold	0.875	0.450	0.128		B	CAP9-04	KTH-2011	R	10
351-975-0630N		Jack, Crimp, Bulkhd	F	Nickel	0.875	0.450	0.128		B	CAP9-04	KTH-2011	R	10
251-975-0630P		Jack, Crimp, Bulkhd	F	Passivated	0.875	0.450	0.128		B	CAP9-04	KTH-2011	R	10
251-975-1160G		Jack, Crimp, Bulkhd	F	Gold	0.875	0.450	0.206		D	CAP9-04	KTH-2001	R	10
351-975-1160H		Jack, Crimp, Bulkhd	F	Gold	0.875	0.450	0.206		D	CAP9-04	KTH-2001	R	10
351-975-1160N		Jack, Crimp, Bulkhd	F	Nickel	0.875	0.450	0.206		D	CAP9-04	KTH-2001	R	10
251-975-1160P		Jack, Crimp, Bulkhd	F	Passivated	0.875	0.450	0.206		D	CAP9-04	KTH-2001	R	10
251-975-1161G		Jack, Crimp, Bulkhd	F	Gold	0.875	0.450	0.219		E	CAP9-04	KTH-2001	R	10
351-975-1161H		Jack, Crimp, Bulkhd	F	Gold	0.875	0.450	0.219		E	CAP9-04	KTH-2001	R	10
351-975-1161N		Jack, Crimp, Bulkhd	F	Nickel	0.875	0.450	0.219		E	CAP9-04	KTH-2001	R	10
251-975-1161P		Jack, Crimp, Bulkhd	F	Passivated	0.875	0.450	0.219		E	CAP9-04	KTH-2001	R	10
871-38-3	M39012/82-3008	Jack, Direct Solder, Panel	F	Passivated	0.520	0.330	0.070	0.250	49	3-482		C	11
871-68-1		Jack, Direct Solder, Panel	F	Gold	0.530	0.300	0.075	0.375		3-652		C	11
871-59-3		Jack, Crimp, Panel, W/P	F	Passivated	0.967	0.325	0.070		16	3-515	KTH-2207	C	12
871-13	M39012/58B4012	Jack, Crimp, Panel	F		0.890	0.330	0.070		B1	CP-439	KTH-2081		12
871-57-3		Jack, Conventional, Panel	F	Passivated	0.950	0.420	0.060	0.130	3	3-515		C	13



## PANEL JACKS

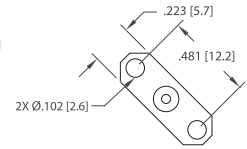
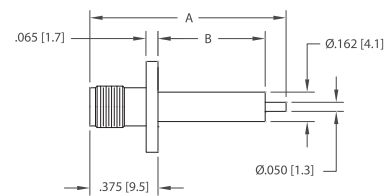
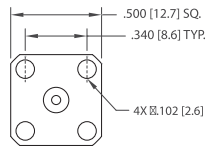
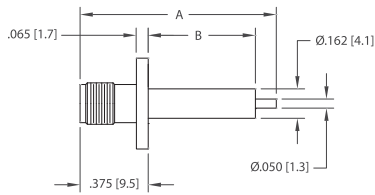


FIGURE 14

FIGURE 15

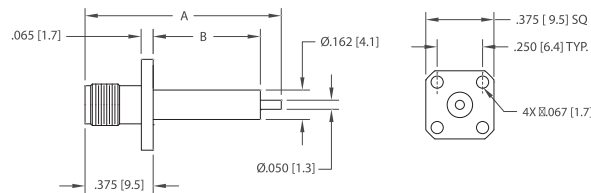


FIGURE 16

Item Number	Military PN	Product Description	Gender	Finish	Dimensions				Cable Group	Cable Procedure	Crimp Die	Mounting Hole	Figure #
					A	B	C	D					
251-065-0040G		Captured, Jack, Panel	F	Gold	1.080	0.590						C	14
251-065-0041G		Non-Captured, Jack, Panel	F	Gold	1.080	0.590						C	14
351-065-0040H		Captured, Jack, Panel	F	Gold	1.080	0.590						C	14
351-065-0041H		Non-Captured, Jack, Panel	F	Gold	1.080	0.590						C	14
351-065-0040N		Captured, Jack, Panel	F	Nickel	1.080	0.590						C	14
351-065-0041N		Non-Captured, Jack, Panel	F	Nickel	1.080	0.590						C	14
251-065-0040P		Captured, Jack, Panel	F	Passivated	1.080	0.590						C	14
251-065-0041P		Non-Captured, Jack, Panel	F	Passivated	1.080	0.590						C	14
251-066-0040G		Captured, Jack, Panel	F	Gold	1.080	0.590						D	15
251-066-0041G		Non-Captured, Jack, Panel	F	Gold	1.080	0.590						D	15
351-066-0040H		Captured, Jack, Panel	F	Gold	1.080	0.590						D	15
351-066-0041H		Non-Captured, Jack, Panel	F	Gold	1.080	0.590						D	15
351-066-0040N		Captured, Jack, Panel	F	Nickel	1.080	0.590						D	15
351-066-0041N		Non-Captured, Jack, Panel	F	Nickel	1.080	0.590						D	15
251-066-0040P		Captured, Jack, Panel	F	Passivated	1.080	0.590						D	15
251-066-0041P		Non-Captured, Jack, Panel	F	Passivated	1.080	0.590						D	15
251-055-0040G		Captured, Jack, Panel	F	Gold	1.080	0.590						S	16
251-055-0041G		Non-Captured, Jack, Panel	F	Gold	1.080	0.590						S	16
351-055-0040H		Captured, Jack, Panel	F	Gold	1.080	0.590						S	16
351-055-0041H		Non-Captured, Jack, Panel	F	Gold	1.080	0.590						S	16
351-055-0040N		Captured, Jack, Panel	F	Nickel	1.080	0.590						S	16
351-055-0041N		Non-Captured, Jack, Panel	F	Nickel	1.080	0.590						S	16
251-055-0040P		Captured, Jack, Panel	F	Passivated	1.080	0.590						S	16
251-055-0041P		Non-Captured, Jack, Panel	F	Passivated	1.080	0.590						S	16

ANGLE PLUGS

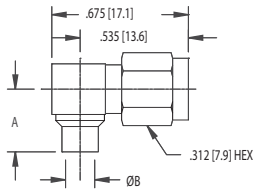


FIGURE 17

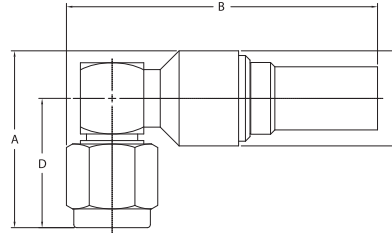


FIGURE 18

Item Number	Military PN	Product Description	Gender	Finish	Dimensions				Cable Group	Cable Procedure	Crimp Die	Mounting Hole	Figure #
					A	B	C	D					
252-900-0631G		Plug, Crimp, Angle	M	Gold	1.00max	0.142			3	CAP9-05	KTH-2015	17	
352-900-0631H		Plug, Crimp, Angle	M	Gold	1.00max	0.142			3	CAP9-05	KTH-2015	17	
352-900-0631N		Plug, Crimp, Angle	M	Nickel	1.00max	0.142			3	CAP9-05	KTH-2015	17	
252-900-0631P		Plug, Crimp, Angle	M	Passivated	1.00max	0.142			3	CAP9-05	KTH-2015	17	
252-900-0630G		Plug, Crimp, Angle	M	Gold	1.00max	0.128			B	CAP9-05	KTH-2011	17	
352-900-0630H		Plug, Crimp, Angle	M	Gold	1.00max	0.128			B	CAP9-05	KTH-2011	17	
352-900-0630N		Plug, Crimp, Angle	M	Nickel	1.00max	0.128			B	CAP9-05	KTH-2011	17	
252-900-0630P		Plug, Crimp, Angle	M	Passivated	1.00max	0.128			B	CAP9-05	KTH-2011	17	
252-900-1160G		Plug, Crimp, Angle	M	Gold	1.00max	0.206			D	CAP9-05	KTH-2001	17	
352-900-1160H		Plug, Crimp, Angle	M	Gold	1.00max	0.206			D	CAP9-05	KTH-2001	17	
352-900-1160N		Plug, Crimp, Angle	M	Nickel	1.00max	0.206			D	CAP9-05	KTH-2001	17	
252-900-1160P		Plug, Crimp, Angle	M	Passivated	1.00max	0.206			D	CAP9-05	KTH-2001	17	
252-900-1161G		Plug, Crimp, Angle	M	Gold	1.00max	0.219			E	CAP9-05	KTH-2001	17	
352-900-1161H		Plug, Crimp, Angle	M	Gold	1.00max	0.219			E	CAP9-05	KTH-2001	17	
352-900-1161N		Plug, Crimp, Angle	M	Nickel	1.00max	0.219			E	CAP9-05	KTH-2001	17	
252-900-1161P		Plug, Crimp, Angle	M	Passivated	1.00max	0.219			E	CAP9-05	KTH-2001	17	
876-64-3		Plug, Crimp, Angle, Weatherproof	M	Passivated	0.690	1.230	0.375	0.510	16	3-546-1	KTH-2207	18	
876-72-3		Plug, Crimp, Angle, Weatherproof	M	Passivated	0.750	1.300	0.380		17	3-546-1	KTH-2242	18	

Part # beginning with 25\* - Stainless Steel Plating  
 Part # beginning with 35\* - Brass Plating

## ANGLE JACKS

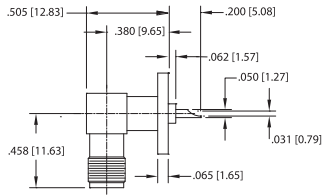


FIGURE 19

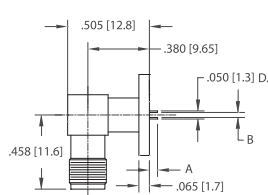


FIGURE 20

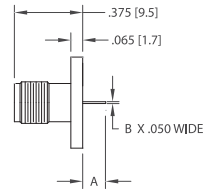


FIGURE 21

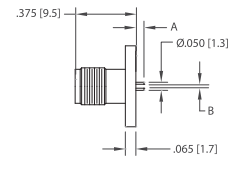


FIGURE 22

## ADAPTERS

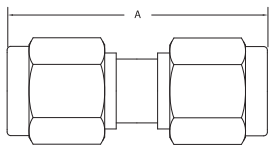


FIGURE 24

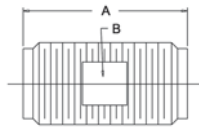


FIGURE 25

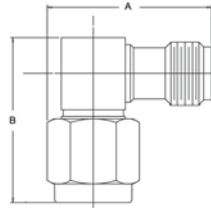


FIGURE 26

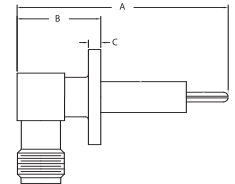
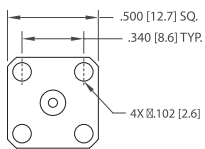
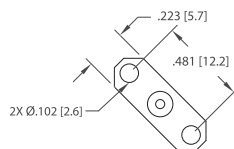


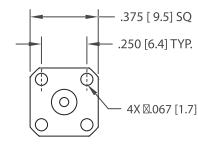
FIGURE 23



\_1



\_2



\_3

Item Number	Military PN	Product Description	Gender	Finish	Dimensions				Cable Group	Cable Procedure	Crimp Die	Mounting Hole	Figure #
					A	B	C	D					
253-065-0000G		Jack, Angle, Panel	F	Gold	0.200	0.062						C	19
353-065-0000H		Jack, Angle, Panel	F	Gold	0.200	0.062						C	19
353-065-0000N		Jack, Angle, Panel	F	Nickel	0.200	0.062						C	19
253-065-0000P		Jack, Angle, Panel	F	Passivated	0.200	0.062						C	19
253-065-0024G		Jack, Angle, Panel	F	Gold	0.050	0.028						C	20_1
253-065-0025G		Jack, Angle, Panel	F	Gold	0.050	0.036						C	20_1
253-065-0023P		Jack, Angle, Panel	F	Passivated	0.050	0.018						C	20_1
253-065-0024P		Jack, Angle, Panel	F	Passivated	0.050	0.028						C	20_1
253-065-0025P		Jack, Angle, Panel	F	Passivated	0.050	0.036						C	20_1
253-066-0022G		Jack, Angle, Panel	F	Gold	0.050	0.012						D	20_2
253-066-0023G		Jack, Angle, Panel	F	Gold	0.050	0.018						D	20_2
253-066-0024G		Jack, Angle, Panel	F	Gold	0.050	0.028						D	20_2
253-066-0025G		Jack, Angle, Panel	F	Gold	0.050	0.036						D	20_2
253-066-0022P		Jack, Angle, Panel	F	Passivated	0.050	0.012						D	20_2
253-066-0023P		Jack, Angle, Panel	F	Passivated	0.050	0.018						D	20_2
253-066-0024P		Jack, Angle, Panel	F	Passivated	0.050	0.028						D	20_2
253-066-0025P		Jack, Angle, Panel	F	Passivated	0.050	0.036						D	20_2
253-055-0022G		Jack, Angle, Panel	F	Gold	0.050	0.012						S	20_3
253-055-0023G		Jack, Angle, Panel	F	Gold	0.050	0.018						S	20_3
253-055-0024G		Jack, Angle, Panel	F	Gold	0.050	0.028						S	20_3
253-055-0025G		Jack, Angle, Panel	F	Gold	0.050	0.036						S	20_3
253-055-0022P		Jack, Angle, Panel	F	Passivated	0.050	0.012						S	20_3
253-055-0023P		Jack, Angle, Panel	F	Passivated	0.050	0.018						S	20_3
253-055-0024P		Jack, Angle, Panel	F	Passivated	0.050	0.028						S	20_3

Item Number	Military PN	Product Description	Gender	Finish	Dimensions				Cable Group	Cable Procedure	Crimp Die	Mounting Hole	Figure #
					A	B	C	D					
253-055-0025P		Jack, Angle, Panel	F	Passivated	0.050	0.036					S	20_3	
251-065-0030G		Captured, Jack, Panel	F	Gold	0.100	0.005					C	21_1	
251-065-0031G		Non-Captured, Jack, Panel	F	Gold	0.100	0.005					C	21_1	
251-065-0030P		Captured, Jack, Panel	F	Passivated	0.100	0.005					C	21_1	
251-065-0031P		Non-Captured, Jack, Panel	F	Passivated	0.100	0.005					C	21_1	
251-066-0030G		Captured, Jack, Panel	F	Gold	0.100	0.005					D	21_2	
251-066-0031G		Non-Captured, Jack, Panel	F	Gold	0.100	0.005					D	21_2	
251-066-0030P		Captured, Jack, Panel	F	Passivated	0.100	0.005					D	21_2	
251-066-0031P		Non-Captured, Jack, Panel	F	Passivated	0.100	0.005					D	21_2	
251-055-0030G		Captured, Jack, Panel	F	Gold	0.100	0.005					S	21_3	
251-055-0031G		Non-Captured, Jack, Panel	F	Gold	0.100	0.005					S	21_3	
251-055-0030P		Captured, Jack, Panel	F	Passivated	0.100	0.005					S	21_3	
251-055-0031P		Non-Captured, Jack, Panel	F	Passivated	0.100	0.005					S	21_3	
251-065-0023G		Jack, Panel	F	Gold	0.050	0.018					C	22_1	
251-065-0024G		Jack, Panel	F	Gold	0.050	0.028					C	22_1	
251-065-0025G		Jack, Panel	F	Gold	0.050	0.036					C	22_1	
251-065-0023P		Jack, Panel	F	Passivated	0.050	0.018					C	22_1	
251-065-0024P		Jack, Panel	F	Passivated	0.050	0.028					C	22_1	
251-065-0025P		Jack, Panel	F	Passivated	0.050	0.036					C	22_1	
251-065-0022G		Jack, Panel	F	Gold	0.050	0.012					C	22_1	
251-065-0022P		Jack, Panel	F	Passivated	0.050	0.012					C	22_1	
251-066-0022G		Jack, Panel	F	Gold	0.050	0.012					D	22_2	
251-066-0023G		Jack, Panel	F	Gold	0.050	0.018					D	22_2	
251-066-0024G		Jack, Panel	F	Gold	0.050	0.028					D	22_2	
251-066-0025G		Jack, Panel	F	Gold	0.050	0.036					D	22_2	
251-066-0022P		Jack, Panel	F	Passivated	0.050	0.012					D	22_2	
251-066-0023P		Jack, Panel	F	Passivated	0.050	0.018					D	22_2	
251-066-0024P		Jack, Panel	F	Passivated	0.050	0.028					D	22_2	
251-066-0025P		Jack, Panel	F	Passivated	0.050	0.036					D	22_2	
251-055-0022G		Jack, Panel	F	Gold	0.050	0.012					S	22_3	
251-055-0023G		Jack, Panel	F	Gold	0.050	0.018					S	22_3	
251-055-0024G		Jack, Panel	F	Gold	0.050	0.028					S	22_3	
251-055-0025G		Jack, Panel	F	Gold	0.050	0.036					S	22_3	
251-055-0022P		Jack, Panel	F	Passivated	0.050	0.012					S	22_3	
251-055-0023P		Jack, Panel	F	Passivated	0.050	0.018					S	22_3	
251-055-0024P		Jack, Panel	F	Passivated	0.050	0.028					S	22_3	
251-055-0025P		Jack, Panel	F	Passivated	0.050	0.036					S	22_3	
253-065-0022G		Jack, Panel	F	Gold	0.050	0.012					C	23_1	
253-065-0023G		Jack, Panel	F	Gold	0.050	0.018					C	23_1	
253-065-0022P		Jack, Panel	F	Passivated	0.050	0.012					C	23_1	
877-120-5		Jack, Panel	F	Silver	1.111	0.440	0.065				E	23	
879-2-1		Within Series Adapter	M-M	Gold	0.880							24	
879-2-3		Within Series Adapter	M-M	Passivated	0.880							24	
879-3		Within Series Adapter	F-F	Gold	0.500	0.250						25	
879-3-3		Within Series Adapter	F-F	Passivated	0.500	0.220						25	
879-1-3		Within Series Adapter	M-F	Passivated	0.650	0.630						26	
879-1-9		Within Series Adapter	M-F	Nickel	0.630	0.650						26	

JACK

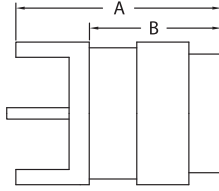


FIGURE 27

ANGLE JACKS

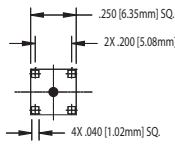
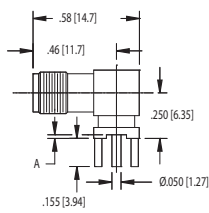


FIGURE 28

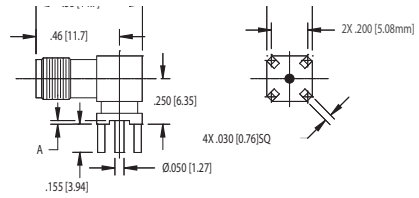


FIGURE 29

BULKHEAD RECEPTACLE

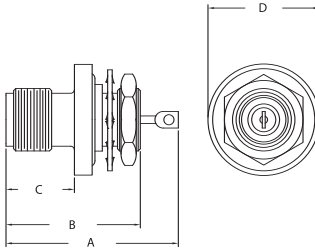


FIGURE 30

RECEPTACLE

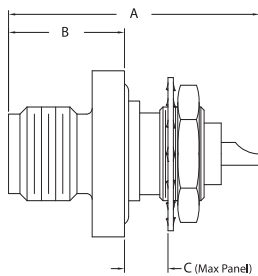


FIGURE 31

ANGLE RECEPTACLE

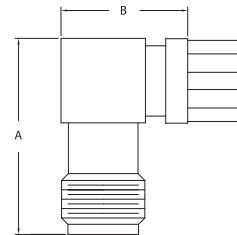


FIGURE 32

Item Number	Military PN	Product Description	Gender	Finish	Dimensions				Cable Group	Cable Procedure	Crimp Die	Mounting Hole	Figure #
					A	B	C	D					
351-085-0030H		Jack, End Launch	F	Gold	0.068	0.073							N/S
351-085-0040H		Jack, End Launch	F	Gold	0.068	0.083							N/S
351-060-0046H		Jack, PCB	F	Gold	0.550	0.395	0.020					O	27
251-060-0040G		Jack, PCB	F	Gold	0.530	0.375						T	27
351-060-0040H		Jack, PCB	F	Gold	0.530	0.375						T	27
877-114-4		Receptacle, PCB	F	Nickel	0.565	0.425							27
877-86-1	M39012/93-3001	Receptacle, PCB	F	Passivated	0.540	0.380						D	27
877-92-1	M39012/93-3002	Receptacle, PCB	F	Gold	0.500	0.380						D	27
253-060-0040G		Jack, PCB, Angle	F	Gold								T	28
353-060-0040H		Jack, PCB, Angle	F	Gold								T	28
353-060-0046H		Jack, PCB, Angle	F	Gold	0.020							O	29
351-060-7540H		Jack, PCB, Bulkhd	F	Gold	0.562	0.415						T	N/S
251-075-0000G		Receptacle, Bulkhd	F	Gold	0.668	0.450	0.312					R	30
251-075-0004G		Receptacle, Bulkhd	F	Gold	0.668	0.415	0.437					R	30
251-075-0000P		Receptacle, Bulkhd	F	Passivated	0.668	0.450	0.312					R	30
251-075-0004P		Receptacle, Bulkhd	F	Passivated	0.668	0.415	0.437					R	30
874-1	M39012/61-4001	Receptacle, Bulkhd	F	Gold	0.670	0.500	0.312	0.430					N/S
874-11-3	M39012/61-3002	Receptacle, Bulkhd	F	Passivated	0.660	0.290	0.290	0.060					30
874-4		Receptacle, Bulkhd	F	Gold	0.680	0.530	0.270	0.440					30
874-2-3	M39012/61-3002	Receptacle	F	Passivated	0.660	0.310	0.180						31
877-93-1	M39012/93-3003	Receptacle	F	Gold	0.470	0.380						D	N/S
877-95-1	M39012/94-3003	Receptacle	F	Gold	0.590	0.460						D	32
877-87-1	M39012/94-3001	Receptacle, Angle, PCB	F	Passivated	0.590	0.370						D	32
877-94-1	M39012/94-3002	Receptacle, Angle, PCB	F	Gold	0.590	0.380						D	32

## PLUGS

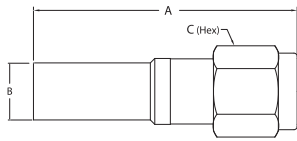


FIGURE 33

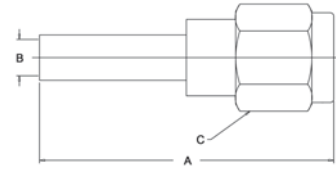


FIGURE 34

Item Number	Military PN	Product Description	Gender	Finish	Dimensions				Cable Group	Cable Procedure	Crimp Die	Mounting Hole	Figure #
					A	B	C	D					
250-900-0631G		Plug, Crimp	M	Gold	1.187 <sub>max</sub>	0.142			3	CAP9-04	KTH-2015		33
350-900-0631H		Plug, Crimp	M	Gold	1.187 <sub>max</sub>	0.142			3	CAP9-04	KTH-2015		33
350-900-0631N		Plug, Crimp	M	Nickel	1.187 <sub>max</sub>	0.142			3	CAP9-04	KTH-2015		33
250-900-0631P		Plug, Crimp	M	Passivated	1.187 <sub>max</sub>	0.142			3	CAP9-04	KTH-2015		33
875-92-3		Plug, Crimp, Weatherproof	M	Passivated	1.040	0.215	0.310		15	3-546-1	KTH-2214		33
875-91-3		Plug, Crimp, Weatherproof	M	Passivated	1.010	0.248	0.312		16	3-546-1	KTH-2207		33
875-100-3		Plug, Crimp, Weatherproof	M	Passivated	1.010	0.299	0.312		17	3-546-1	KTH-2242		33
875-101-3		Plug, Crimp, Weatherproof	M	Passivated	0.930	0.147	0.312		21	3-546	KTH-2244		33
250-900-0630G		Plug, Crimp	M	Gold	1.187 <sub>max</sub>	0.128			B	CAP9-04	KTH-2011		33
350-900-0630H		Plug, Crimp	M	Gold	1.187 <sub>max</sub>	0.128			B	CAP9-04	KTH-2011		33
350-900-0630N		Plug, Crimp	M	Nickel	1.187 <sub>max</sub>	0.128			B	CAP9-04	KTH-2011		33
250-900-0630P		Plug, Crimp	M	Passivated	1.187 <sub>max</sub>	0.128			B	CAP9-04	KTH-2011		33
875-105-3		Plug, Crimp, Weatherproof	M	Passivated	0.944	0.120	0.310		B1	3-546-8	KTH-2081		33
250-900-1160G		Plug, Crimp	M	Gold	1.187 <sub>max</sub>	0.206			D	CAP9-04	KTH-2001		33
350-900-1160H		Plug, Crimp	M	Gold	1.187 <sub>max</sub>	0.206			D	CAP9-04	KTH-2001		33
350-900-1160N		Plug, Crimp	M	Nickel	1.187 <sub>max</sub>	0.206			D	CAP9-04	KTH-2001		33
250-900-1160P		Plug, Crimp	M	Passivated	1.187 <sub>max</sub>	0.206			D	CAP9-04	KTH-2001		33
250-900-1161G		Plug, Crimp	M	Gold	1.187 <sub>max</sub>	0.219			E	CAP9-04	KTH-2001		33
350-900-1161H		Plug, Crimp	M	Gold	1.187 <sub>max</sub>	0.219			E	CAP9-04	KTH-2001		33
350-900-1161N		Plug, Crimp	M	Nickel	1.187 <sub>max</sub>	0.219			E	CAP9-04	KTH-2001		33
250-900-1161P		Plug, Crimp	M	Passivated	1.187 <sub>max</sub>	0.219			E	CAP9-04	KTH-2001		33
875-3-3	M39012/55B3116	Plug, Crimp	M	Passivated	0.990	0.220	0.310		E1	CP-432	KTH-2001		34
875-21-17	M39012/55-3502	Plug, Crimp	M	Passivated	0.990	0.220	0.310		E2	CP-432	KTH-2113		34
875-21-18	M39012/55-4502	Plug, Crimp	M	Passivated	0.990	0.220	0.310		E1	CP-493	KTH-2113		34
875-21-3	M39012/55-3602	Plug, Crimp	M	Passivated	0.990	0.220	0.310		E2	CP-432	KTH-2113		34
875-110-4		Plug, Crimp	M	Nickel	1.210	0.210	0.400		84	3-712	KTH-2026		N/S
875-57-1		Plug, Crimp	M	Gold	0.990	0.120	0.310		B1	CP-439	KTH-2021		34
875-9 M09		Plug, Crimp	M	Gold	0.870	0.120	0.310		B1	CP-439	KTH-2021		34
875-9-3	M39012/55B3112	Plug, Crimp	M	Passivated	0.930	0.120	0.310		B1	CP-439	KTH-2021		34
875-1-3	M39012/55B3114	Plug, Crimp	M	Passivated	0.990	0.210	0.310		D	CP-432	KTH-2001		34



- 50 Ohm Nominal Impedance.
- Push/Pull connection system does not require special tooling for mating/unmating.
- When mated, connectors can rotate 360 degrees.
- Mate with standard SMA jacks with thread lengths of .200" +/- .005".
- Designs available for flexible and semi-rigid cables.
- Frequency Range: Up to 6 GHz

**SPECIFICATIONS**

**MATERIAL**

Body:	Brass
Crimp Sleeves:	Copper Alloy
Center Contacts:	Brass (Male) Copper Alloy (Female)
Outer Contacts:	Copper Alloy
Insulators:	PTFE

**FINISHES**

Body:	Gold or Nickel
Center Contacts:	Gold

**ELECTRICAL**

Impedance:	50 Ohms
Frequency Range:	DC to 6 GHz
VSWR:	1.25 Max
Return Loss:	-19.1 dB Minimum
Insulation Resistance:	5,000 Megohms Minimum

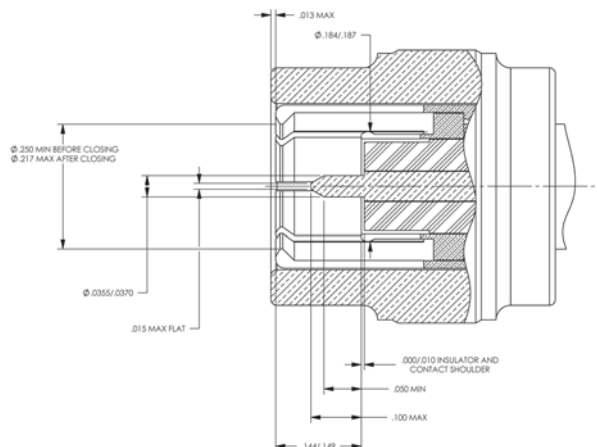
**MECHANICAL**

Life:	500 Cycles
Mating Force:	10 Pounds Maximum
Unmating Force:	10 Pounds Maximum
Connector Retention:	30 Pounds Minimum

**ENVIRONMENTAL**

Temperature Range:	-65° C to +165° C
Vibration:	MIL-STD-202, Method 204, Condition B
Shock:	MIL-STD-202, Method 213, Condition A
Thermal Shock:	MIL-STD-202, Method 107, Condition B
Corrosion:	MIL-STD-202, Method 101, Condition B
Moisture Resistance:	MIL-STD-202, Method 106

**INTERFACE DIMENSIONS**





CABLE PLUGS, SOLDER TYPE - SEMI-RIGID CABLE

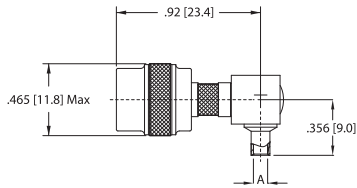


FIGURE 1

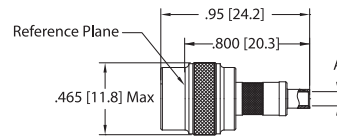


FIGURE 2

CABLE PLUGS, CRIMP TYPE - FLEXIBLE CABLE

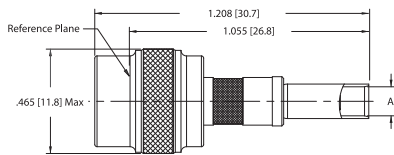


FIGURE 3

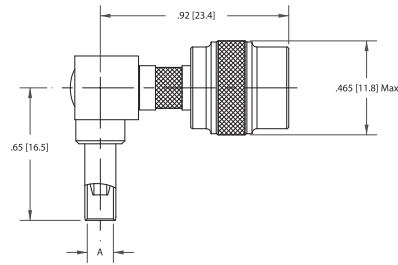
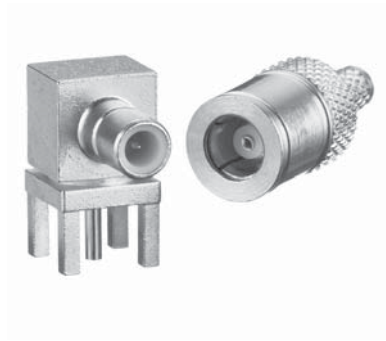


FIGURE 4

Item Number	Military PN	Product Description	Gender	Finish	Dimensions				Cable Group	Cable Procedure	Crimp Die	Mounting Hole	Figure #
					A	B	C	D					
152-500-1410N		Plug, Solder	M	Gold	0.145				49				1
152-500-0850N		Plug, Solder	M	Gold	0.090				50				1
150-500-0850N		Plug, Solder	M	Gold	0.090				50				2
150-500-1410N		Plug, Solder	M	Gold	0.145				49				2
150-900-0631N		Plug, Crimp	M	Nickel	0.142				3		KTH-2015		3
150-900-0630N		Plug, Crimp	M	Nickel	0.128				B		KTH-2011		3
152-900-0631N		Plug, Crimp	M	Nickel	0.142				3		KTH-2015		4
152-900-0630N		Plug, Crimp	M	Nickel	0.128				B		KTH-2011		4



- Available in 50 Ohm and 75 Ohm versions.
- Snap-on interface reduces installation time.
- Self-cleaning outer spring withstands moderate vibration.
- Small & lightweight.
- Frequency Range: Up to 4 GHz

**SPECIFICATIONS**

**MATERIAL**

Body:	Brass
Crimp Sleeves:	Annealed Copper Alloy
Contacts:	Brass (Male) Copper Alloy (Female)
Insulators:	PTFE
Lockwashers:	Phosphor Bronze

**FINISHES**

Body:	Gold or Nickel
Center Contacts:	Gold

**MECHANICAL**

Life:	500 Cycles
Engagement Force:	14 Pounds Maximum
Disengagement Force:	2 Pounds Minimum 14 Pounds Maximum

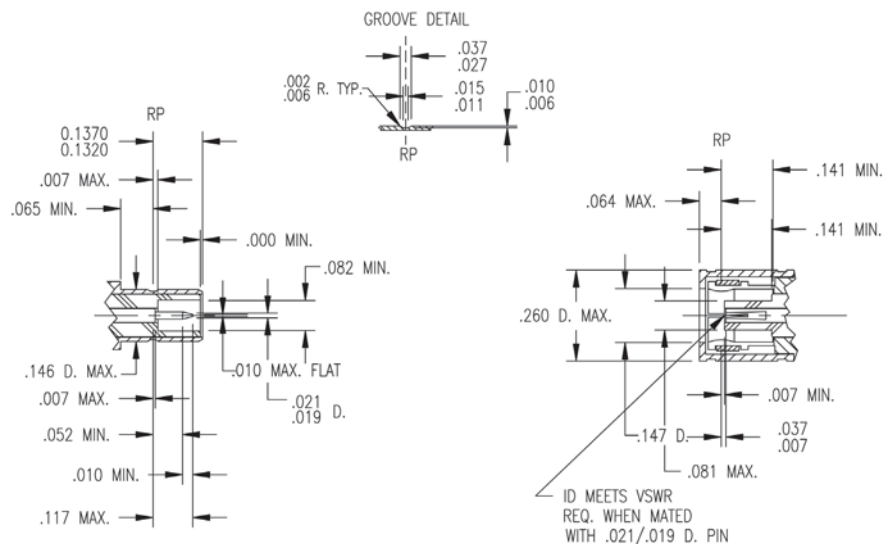
**ELECTRICAL**

Impedance:	50 Ohms
Frequency Range:	DC to 4 GHz
VSWR:	
RG196 or similar	Straight: 1.30 + .04F Right Angle: 1.45 + .06F
RG 316 or similar	Straight: 1.25 + .04F Right Angle: 1.35 + .04F
Insertion Loss:	.25 dB Max at 4 GHz

**ENVIRONMENTAL**

Temperature Range:	-65° C to +165° C
Vibration:	MIL-STD-202, Method 204, Condition B
Shock:	MIL-STD-202, Method 213, Condition B
Corrosion:	MIL-STD-202, Method 101, Condition B
Temperature Cycling:	MIL-STD-202, Method 102, Condition C

**INTERFACE DIMENSIONS**



## CABLE PLUGS, CRIMP TYPE - FLEXIBLE CABLE

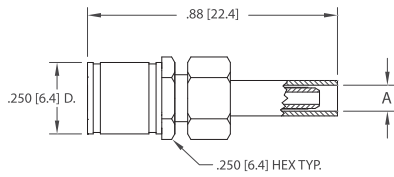


FIGURE 1

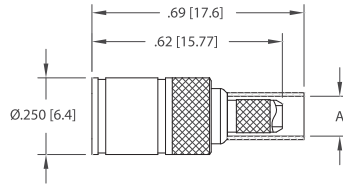


FIGURE 2

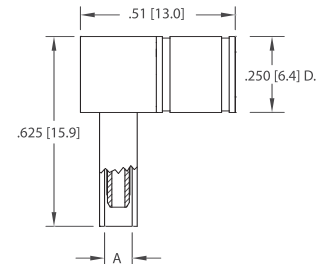


FIGURE 3

## CABLE JACKS, CRIMP TYPE - FLEXIBLE CABLE

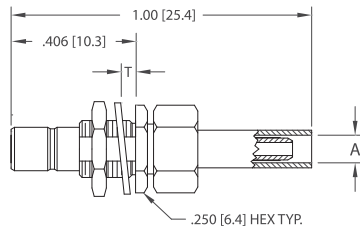


FIGURE 4

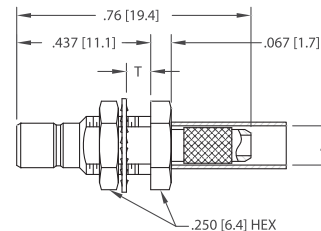


FIGURE 5

Item Number	Military PN	Product Description	Gender	Finish	Dimensions				Cable Group	Cable Procedure	Crimp Die	Mounting Hole	Figure #
					A	B	C	T					
510-800-0631H		Plug, Crimp/Clamp	F	Gold	0.142				3	CAP8-02	KTH-2015		1
510-800-0631N		Plug, Crimp/Clamp	F	Nickel	0.142				3	CAP8-02	KTH-2015		1
510-800-0360H		Plug, Crimp/Clamp	F	Gold	0.091				A	CAP8-02	KTH-2008		1
510-800-0360N		Plug, Crimp/Clamp	F	Nickel	0.091				A	CAP8-02	KTH-2008		1
510-800-0630H		Plug, Crimp/Clamp	F	Gold	0.128				B	CAP8-02	KTH-2011		1
510-800-0630N		Plug, Crimp	F	Nickel	0.128				B	CAP8-02	KTH-2011		1
510-900-0360H		Plug, Crimp	F	Gold	0.091				A	CAP9-08	KTH-2008		2
510-900-0360N		Plug, Crimp	F	Nickel	0.091				A	CAP9-08	KTH-2008		2
510-900-0630H		Plug, Crimp	F	Gold	0.128				B	CAP9-08	KTH-2011		2
510-900-0630N		Plug, Crimp	F	Nickel	0.128				B	CAP9-08	KTH-2011		2
512-900-0631H		Plug, Angle, Crimp	F	Gold	0.142				3	CAP9-06	KTH-2015		3
512-900-0631N		Plug, Angle, Crimp	F	Nickel	0.142				3	CAP9-06	KTH-2015		3
512-900-0360H		Plug, Angle, Crimp	F	Gold	0.091				A	CAP9-06	KTH-2008		3
512-900-0360N		Plug, Angle, Crimp	F	Nickel	0.091				A	CAP9-06	KTH-2008		3
512-900-0630H		Plug, Angle, Crimp	F	Gold	0.128				B	CAP9-06	KTH-2011		3
512-900-0630N		Plug, Angle, Crimp	F	Nickel	0.128				B	CAP9-06	KTH-2011		3
511-880-0631H		Jack, Bulkhd, Crimp/Clamp	M	Gold	0.142			0.093	3	CAP8-02	KTH-2015	P	4
511-880-0631N		Jack, Bulkhd	M	Nickel	0.142			0.093	3	CAP8-02	KTH-2015	P	4
511-880-0360H		Jack, Bulkhd, Crimp/Clamp	M	Gold	0.091			0.093	A	CAP8-02	KTH-2008	P	4
511-880-0360N		Jack, Bulkhd, Crimp/Clamp	M	Nickel	0.091			0.093	A	CAP8-02	KTH-2008	P	4
511-880-0630H		Jack, Bulkhd, Crimp/Clamp	M	Gold	0.128			0.093	B	CAP8-02	KTH-2011	P	4
511-880-0630N		Jack, Bulkhd, Crimp/Clamp	M	Nickel	0.128			0.093	B	CAP8-02	KTH-2011	P	4
511-980-0631H		Jack, Bulkhd, Crimp	M	Gold	0.142			0.093	3	CAP9-08	KTH-2015	P	5
511-980-0631N		Jack, Bulkhd, Crimp	M	Nickel	0.142			0.093	3	CAP9-08	KTH-2015	P	5
511-980-0360H		Jack, Bulkhd, Crimp	M	Gold	0.091			0.093	A	CAP9-08	KTH-2008	P	5
511-980-0360N		Jack, Bulkhd, Crimp	M	Nickel	0.091			0.093	A	CAP9-08	KTH-2008	P	5
511-980-0630H		Jack, Bulkhd, Crimp	M	Gold	0.128			0.093	B	CAP9-08	KTH-2011	P	5
511-980-0630N		Jack, Bulkhd, Crimp	M	Nickel	0.128			0.093	B	CAP9-08	KTH-2011	P	5

CABLE PLUGS, SOLDER TYPE - SEMI-RIGID CABLE

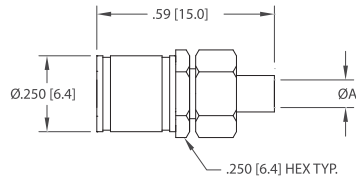


FIGURE 6

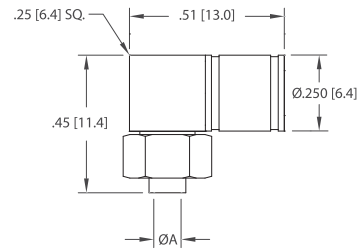


FIGURE 7

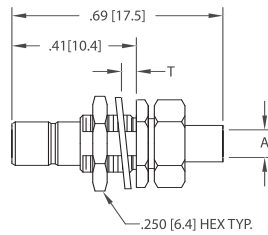
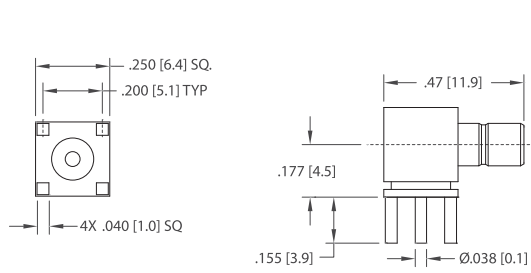


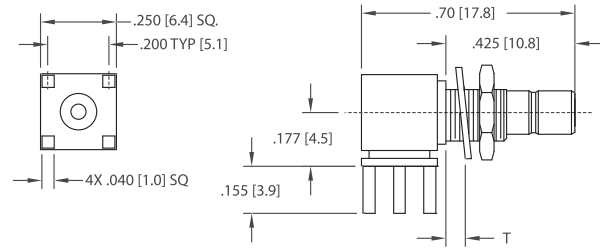
FIGURE 8

Item Number	Military PN	Product Description	Gender	Finish	Dimensions				Cable Group	Cable Procedure	Crimp Die	Mounting Hole	Figure #
					A	B	C	T					
510-600-0850N		Plug, Solder/Clamp	F	Nickel	0.090				48	CAP6-01			6
510-600-1410H		Plug, Solder/Clamp	F	Gold	0.144				49	CAP6-01			6
510-600-1410N		Plug, Solder/Clamp	F	Nickel	0.144				49	CAP6-01			6
510-600-0850H		Plug, Solder/Clamp	F	Gold	0.090				48	CAP6-01			6
512-600-0850H		Plug, Angle, Solder/Clamp	F	Gold	0.090				48	CAP6-02			7
512-600-0850N		Plug, Angle, Solder/Clamp	F	Nickel	0.090				48	CAP6-02			7
512-600-1410H		Plug, Angle, Solder/Clamp	F	Gold	0.144				49	CAP6-02			7
512-600-1410N		Plug, Angle, Solder/Clamp	F	Nickel	0.144				49	CAP6-02			7
511-680-0850H		Jack, Bulkhd, Solder/Clamp	M	Gold	0.090			0.093	48	CAP6-01		P	8
511-680-1410H		Jack, Bulkhd, Solder/Clamp	M	Gold	0.144			0.093	B	CAP6-01		P	8

**PCB JACK**

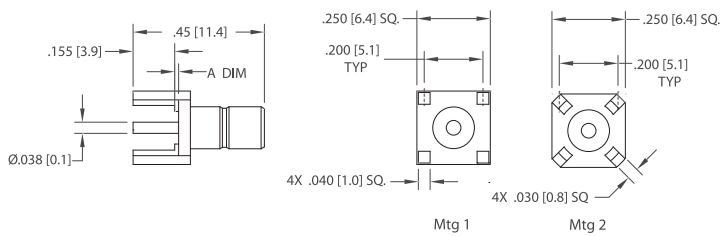


**FIGURE 9**



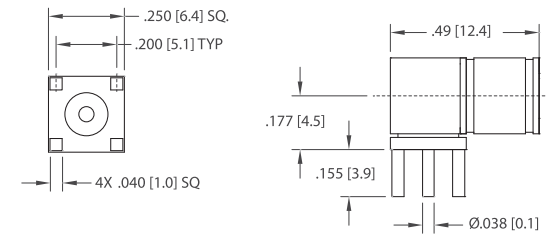
**FIGURE 10**

**PCB JACK**

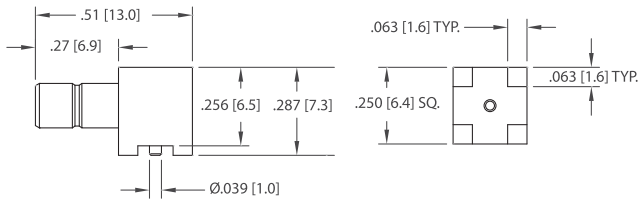


**FIGURE 11**

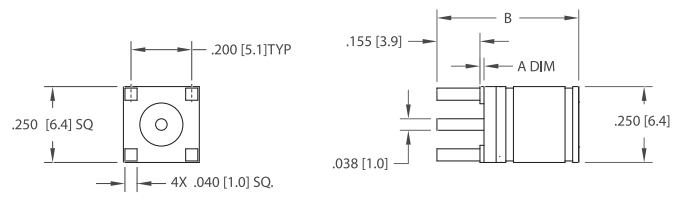
**PCB PLUG**



**FIGURE 13**

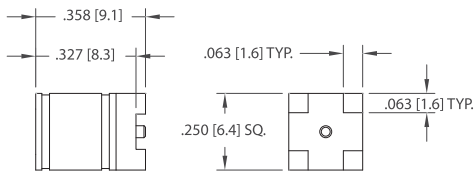


**FIGURE 12**



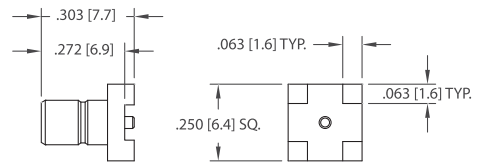
**FIGURE 14**

**SURFACE MOUNT PLUG**



**FIGURE 15**

**SURFACE MOUNT JACK**



**FIGURE 16**

CABLE JACKS, SOLDER TYPE

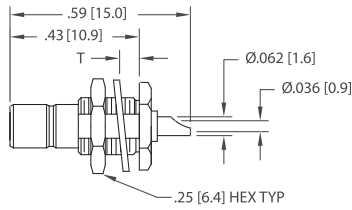


FIGURE 17

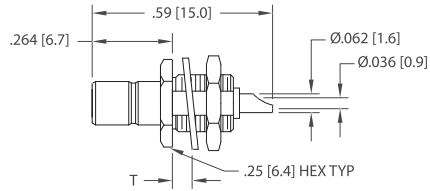


FIGURE 18

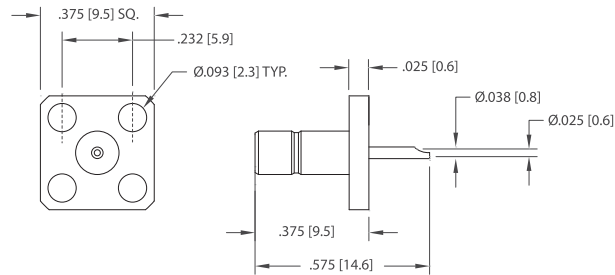
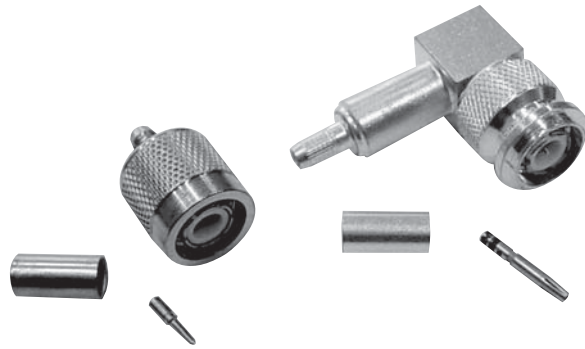


FIGURE 19

Item Number	Military PN	Product Description	Gender	Finish	Dimensions				Cable Group	Cable Procedure	Crimp Die	Mounting Hole	Figure #
					A	B	C	T					
513-060-0040H		Jack, Angle, PCB	M	Gold							U	9	
513-060-0040N		Jack, Angle, PCB	M	Nickel							U	9	
513-060-0080H		Jack, Angle, Bulkhd, PCB	M	Gold				0.093			U & P	10	
513-060-0080N		Jack, Angle, Bulkhd, PCB	M	Nickel				0.093			U & P	10	
511-060-0040H		Jack, PCB	M	Gold	0.000						U	11_1	
511-060-0040N		Jack, PCB	M	Nickel	0.000						U	11_1	
511-060-0047H		Jack, PCB	M	Gold	0.000						0	11_2	
511-060-0048H		Jack, PCB	M	Gold	0.020						0	11_2	
511-060-0047N		Jack, PCB	M	Nickel	0.000						0	11_2	
511-060-0048N		Jack, PCB	M	Nickel	0.020						0	11_2	
513-077-0040H		Jack, Angle, PCB, Surface Mt	M	Gold								12	
512-060-0040H		Plug, Angle, PCB	F	Gold							U	13	
512-060-0040N		Plug, Angle, PCB	F	Nickel							U	13	
510-060-0040H		Plug, PCB	F	Gold	0.000	0.470					U	14	
510-060-0047H		Plug, PCB	F	Gold	0.020	0.490					U	14	
510-060-0040N		Plug, PCB	F	Nickel	0.000	0.470					U	14	
510-060-0047N		Plug, PCB	F	Nickel	0.020	0.490					U	14	
510-077-0040H		Plug, PCB, Surface Mt	F	Gold								15	
511-077-0040H		Jack, PCB, Surface Mt	M	Gold								16	
511-080-0000H		Receptacle, Bulkhd	M	Gold				0.093			P	17	
511-080-0001H		Receptacle, Bulkhd	M	Gold				0.093			P	17	
511-080-0000N		Receptacle, Bulkhd	M	Nickel				0.093			P	17	
511-080-0001N		Receptacle, Bulkhd	M	Nickel				0.093			P	17	
511-082-0000H		Receptacle, Bulkhd	M	Gold				0.093			P	18	
511-082-0000N		Receptacle, Bulkhd	M	Nickel				0.093			P	18	
511-071-0000H		Receptacle, Panel	M	Gold							V	19	
511-071-0000N		Receptacle, Panel	M	Nickel							V	19	



- 50 Ohm & 75 Ohm versions available.
- Miniature size connector with threaded coupling.
- Withstands shock & vibration, ideal for harsh environments.
- Keyed versions available to prevent mismatching and misalignment in critical applications.
- Commercial and Military-Specified versions available.
- Frequency Range: Up to 11 GHz

## SPECIFICATIONS

### MATERIAL

Body:	Brass
Crimp Sleeves:	Commercial Bronze Alloy
Center Contacts:	Brass (Male) Beryllium Copper (Female)
Outer Contacts:	Beryllium Copper (Male)
Insulators:	PTFE
Gaskets & Seals:	Silicone Rubber

### FINISHES

Body:	Silver or Nickel
Center Contacts:	Gold

### ELECTRICAL

Impedance:	50 Ohms or 75 Ohms
Frequency Range:	DC to 11 GHz
Voltage Rating:	500 Volts RMS
VSWR:	1.30 Max, DC to 11 GHz
Insertion Loss:	.18 dB Max at 9 GHz

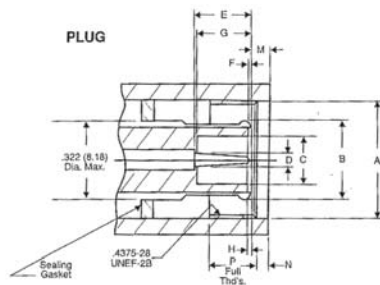
### MECHANICAL

Life:	500 Cycles
Cable Retention:	40 Pounds Minimum

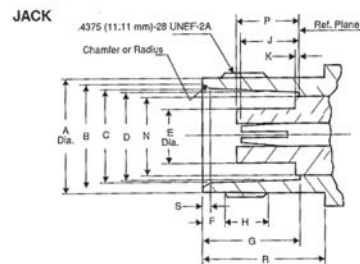
### ENVIRONMENTAL

Temperature Range:	-65° C to +165° C
Vibration:	MIL-STD-202, Method 204, Condition B
Shock:	MIL-STD-202, Method 213, Condition I
Corrosion:	MIL-STD-202, Method 101, Condition B
Moisture Resistance:	MIL-STD-202, Method 106

## INTERFACE DIMENSIONS



Dim Ltr	Inches (mm)		Dim Ltr	Inches (mm)	
	Minimum	Maximum		Minimum	Maximum
A	.440 (11.18)		G	.208 (5.28)	.228 (5.79)
B	Gauge Test		H	.003 (0.08)	.040 (1.02)
C	.190 (4.83)		M		.078 (1.98)
D	.052 (1.32)	.054 (1.37)	N	.063 (1.60)	
E	.210 (5.33)	.230 (5.84)	P	.156 (3.96)	
F	.006 (0.15)				



Dim Ltr	Inches (mm)		Dim Ltr	Inches (mm)	
	Minimum	Maximum		Minimum	Maximum
A	.378 (9.60)	.381 (9.68)	H	.187 (4.75)	
B	.346 (8.79)	.356 (9.04)	J	.186 (4.72)	.206 (5.23)
C	.327 (8.31)	.333 (8.46)	K		.006 (0.15)
D	.319 (8.10)	.321 (8.15)	N		.256 (6.50)
E		.186 (4.72)	P	.188 (4.78)	.208 (5.28)
F	.068 (1.73)	.088 (2.24)	R	.414 (10.52)	
G	.327 (8.31)	.335 (8.51)	S	.015 (0.38)	.030 (0.76)

**JACK - CONVENTIONAL**

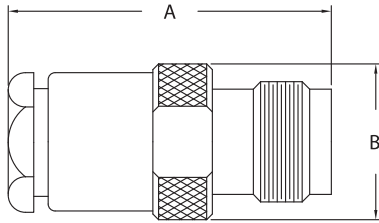


FIGURE 1

**PANEL JACK - CONVENTIONAL**

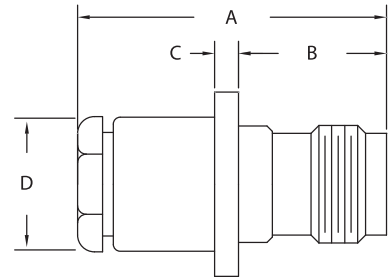


FIGURE 2

**JACKS - K-GRIP, JR.**

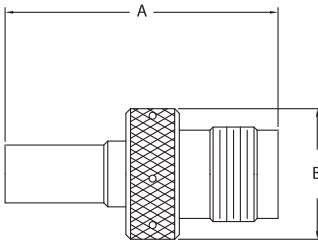


FIGURE 3

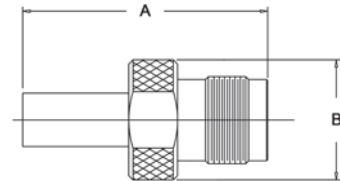


FIGURE 4

Item Number	Military PN	Product Description	Gender	Finish	Dimensions				Cable Group	Cable Procedure	Crimp Die	Mounting Hole	Figure #
					A	B	C	D					
KA-39-87	M39012/27-0101	Jack, Conventional	F	Silver	1.150	0.560			DE	CP-1050			1
121-25-5		Jack, Conventional, Panel	F	Silver	1.250	0.560	0.090	0.500	3	CP-1050		*	2
KA-19-181	M39012/29-0018	Jack, Conventional, Panel	F	Silver	1.150	0.550	0.090	0.500	B1	CP-1050		*	2
KA-19-176	M39012/29-0101	Jack, Conventional, Panel	F	Silver	1.150	0.550	0.090	0.500	DE	CP-1050		*	2
2431-78-10		Jack, Conventional, Panel, Keyed	F		1.160	1.000	0.090	0.210		3-355			N/S
2431-78-5		Jack, Conventional, Panel, Keyed	F		1.160	1.000	0.090	0.210		3-355			N/S
123-22-5		Jack, Crimp, Weatherproof	F	Silver	1.170	0.580			16	3-546-1	KTH-2121		3
123-23-9		Jack, Crimp, Weatherproof	F	Nickel	1.720	0.590			18	3-546-2	KTH-2212		3
123-27-9		Jack, Crimp, Weatherproof	F	Nickel	1.800	0.730			20	3-546-2	KTH-2229		3
KA-39-82		Jack, Crimp, Weatherproof	F	Nickel	1.200	0.580			D	CP-5401	KTH-2061		3
KA-39-85		Jack, Crimp, Weatherproof	F	Nickel	1.200	0.560			E1	CP-5401	KTH-2061		3
KA-39-100 M06		Jack, Crimp, Weatherproof	F	Nickel	1.810	0.500			N3	CP-5402	KTH-2105		3
KA-39-79	M39012/27-0503	Jack, Crimp	F	Silver	1.180	0.580			E1	CP-465	KTH-2001		4
KA-39-76	M39012/27-0504	Jack, Crimp	F	Silver	1.170	0.560			D	CP-465	KTH-2001		4

\*Please Contact Customer Service for Additional Information



**BULKHEAD JACK - CONVENTIONAL**

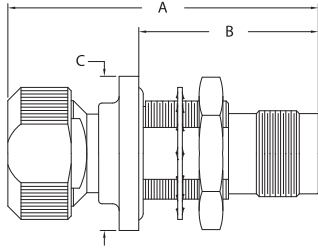


FIGURE 5

**ANGLE JACK - K-GRIP, JR.**

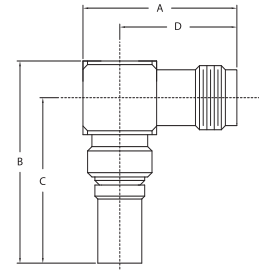


FIGURE 6

**BULKHEAD JACKS - K-GRIP, JR.**

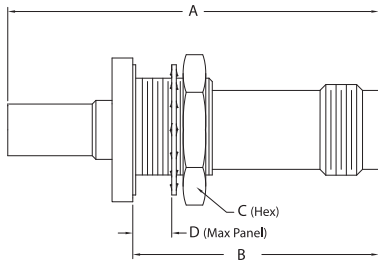


FIGURE 7

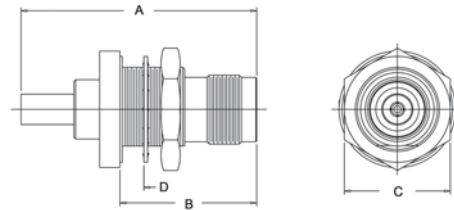


FIGURE 8

Item Number	Military PN	Product Description	Gender	Finish	Dimensions				Cable Group	Cable Procedure	Crimp Die	Mounting Hole	Figure #
					A	B	C	D					
KA-11-07		Jack, Conventional, Bulkhd	F		1.580	0.220				CP-1006		X	5
KA-19-142		Jack, Conventional, Bulkhd	F	Nickel	1.470	0.860	0.730		B1	CP-1004.1			5
122-32-5	M39012/28-0018	Jack, Conventional, Bulkhd	F	Silver	1.250	0.810	0.690		B1	3-527		X	5
122-50-5		Jack, Conventional, Bulkhd	F	Silver	1.250	0.810	0.690		B1	3-527		X	5
KA-19-171	M39012/28-0018	Jack, Conventional, Bulkhd	F	Silver	1.150	0.810	0.690		B1	CP-1050		X	5
KA-19-19	M39012/28-0101	Jack, Conventional, Bulkhd	F	Silver	1.150	0.810	0.690		D	CP-1004		X	5
122-27-5	M39012/28-0101	Jack, Conventional, Bulkhd	F	Silver	1.250	0.810	0.690		E1	3-526		X	5
KA-19-172	M39012/28-0102	Jack, Conventional, Bulkhd	F	Silver	1.160	0.690	0.260		G	CP-1050		X	5
123-24-9		Jack, Crimp, Angle, Weatherproof	F	Nickel	1.050	1.370	1.100	0.800	17	3-546-1	KTH-2216		6
123-28-9		Jack, Crimp, Angle, Weatherproof	F	Nickel	1.050	1.930	1.680	0.800	20	3-546-2	KTH-2229		6
122-37-9		Jack, Crimp, Bulkhd	F	Nickel	1.780	1.180	0.690		16	3-546-1	KTH-2161	X	7
122-3-5	M39012/28-0022	Jack, Crimp, Bulkhd	F	Silver	1.620	0.810	0.690		B1	CP-465	KTH-2011	X	7
122-55-9		Jack, Crimp, Bulkhd	F	Nickel	1.490	0.810	0.630	0.242	B1	3-646	KTH-2021	X	8
KA-19-42		Jack, Crimp, Bulkhd	F	Silver	1.390	0.800	0.630	0.242	B1	CP-407	KTH-2032	X	8
KA-19-60		Jack, Crimp, Bulkhd	F	Nickel	1.390	0.800	0.630	0.242	B1	CP-407	KTH-2032	X	8
KA-19-151	M39012/28-0502	Jack, Crimp, Bulkhd	F	Silver	1.400	0.810	0.630	0.241	C2	CP-465	KTH-2007	X	8
KA-19-101	M39012/28-0010	Jack, Crimp, Bulkhd	F	Silver	1.550	0.810	0.630	0.241	D	CP-465	KTH-2001	X	8
KA-19-153	M39012/28-0504	Jack, Crimp, Bulkhd	F	Silver	1.400	0.810	0.630	0.241	D	CP-465	KTH-2001	X	8
KA-19-102	M39012/28-0011	Jack, Crimp, Bulkhd	F	Silver	1.550	0.810	0.630	0.241	E1	CP-465	KTH-2001	X	8
KA-19-152	M39012/28-0503	Jack, Crimp, Bulkhd	F	Silver	1.400	0.810	0.630	0.241	E1	CP-465	KTH-2001	X	8
KA-19-146	M39012/28-0021	Jack, Crimp, Bulkhd	F	Silver	1.550	0.810	0.630	0.241	H	CP-465	KTH-2002	X	8

ANGLE PANEL JACK - K-GRIP, JR.

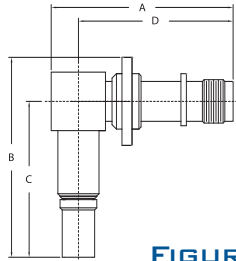


FIGURE 9

PANEL JACK - K-GRIP

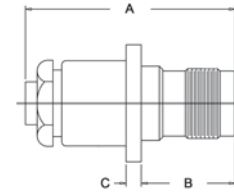


FIGURE 10

PANEL JACKS - K-GRIP, JR.

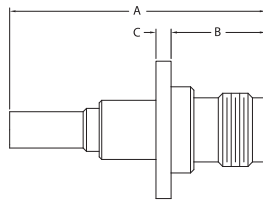


FIGURE 11

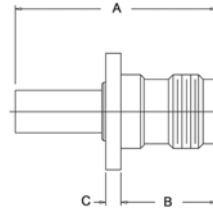


FIGURE 12

Item Number	Military PN	Product Description	Gender	Finish	Dimensions				Cable Group	Cable Procedure	Crimp Die	Mounting Hole	Figure #
					A	B	C	D					
2430-2-16		Jack, Crimp, Angle, Panel, Weatherproof	F	Nickel	1.670	1.840	1.430	1.420	17	3-546-2	KTH-2216	*	9
KA-19-25		Jack, Crimp, Panel	F	Silver	1.240	0.640	0.090		D	CP-201A	KTH-2001	*	10
KA-19-51		Jack, Crimp, Panel	F	Silver	1.240	0.640	0.090		D	CP-201A	KTH-2001	*	10
KA-39-93 M07		Jack, Crimp, Panel, Tee	F	Silver	2.080	0.720	1.800			3-86	KTH-2024		N/S
121-11-9		Jack, Crimp, Panel	F	Nickel	1.330	0.560	0.080		A	CP-1901	KTH-2008	*	N/S
611-1-9		75 Ohm, Jack, Crimp, Panel, W/P	F	Nickel	1.590	0.651	0.089		B2	3-661-4	KTH-2277	*	11
KA-19-195 M06		Jack, Crimp, Panel, W/P	F	Nickel	1.810	0.560	0.090		2	CP-480	KTH-1079	*	11
121-35-9		Jack, Crimp, Panel, W/P	F	Nickel	1.520	0.560	0.090		15	3-546-1	KTH-2214	*	11
121-36-9		Jack, Crimp, Panel, W/P	F	Nickel	1.400	0.560	0.090		16	3-546-1	KTH-2161	*	11
121-44-9		Jack, Crimp, Panel, W/P	F	Nickel	1.400	0.560	0.090		16	3-546-1	KTH-2161	*	11
2431-84-6		Jack, Crimp, Panel, W/P, Keyed	F	Nickel	1.520	0.930	0.090		16	3-546-1	KTH-2161	*	11
121-39-7		Jack, Crimp, Panel, W/P	F	Nickel	1.430	0.560	0.090		17	3-546-1	KTH-2216	*	11
121-39-9		Jack, Crimp, Panel, W/P	F	Nickel	1.430	0.560	0.090		17	3-546-1	KTH-2216	*	11
121-46-9		Jack, Crimp, Panel, W/P	F	Nickel	1.430	0.560	0.090		17	3-546-1	KTH-2216	*	11
121-38-9		Jack, Crimp, Panel, W/P	F	Nickel	1.800	0.560	0.090		19	3-546-2	KTH-2213	*	11
KA-19-143		Jack, Crimp, Panel, W/P	F	Nickel	1.440	0.560	0.090		D	CP-5401	KTH-2061	*	11
KA-19-216 M06		Jack, Crimp, Panel, W/P	F	Nickel	1.180	0.560	0.090		E1	CP-5401	KTH-2061	*	11
KA-19-213 M06		Jack, Crimp, Panel, W/P	F	Nickel	1.810	0.560	0.090		N3	CP-5402	KTH-2105	*	11
KA-19-198 M06		Jack, Crimp, Panel, W/P	F	Nickel	1.440	0.560	0.090			CP-5401	KTH-2128	*	11
KA-19-83		Jack, Crimp, Panel, W/P	F	Nickel	1.410	0.560	0.090		45	CP-5041	KTH-2161	*	11
121-52-9		Jack, Crimp, Panel, Iso Grnd, W/P	F	Nickel	1.520	0.790	0.090		15	3-546-1	KTH-2214	*	11
121-40-9		Jack, Crimp, Panel, Iso Grnd, W/P	F	Nickel	1.410	0.790	0.090		16	3-546-1	KTH-2161	*	11
121-37-9		Jack, Crimp, Panel, W/P	F	Nickel	1.710	0.560	0.090		18	3-546-2	KTH-2212	*	12
121-45-9		Jack, Crimp, Panel, W/P	F	Nickel	1.710	0.560	0.090		18	3-546-2	KTH-2212	*	12
KA-19-214	M39012/29-0022	Jack, Crimp, Panel	F	Silver	1.310	0.560	0.090		B1	CP-465	KTH-2011	*	12
KA-19-155	M39012/29-0502	Jack, Crimp, Panel	F	Silver	1.180	0.560	0.090		C2	CP-465	KTH-2007	*	12
KA-19-157	M39012/29-0504	Jack, Crimp, Panel	F	Silver	1.180	0.560	0.090		D	CP-465	KTH-2001	*	12
KA-19-156	M39012/29-0503	Jack, Crimp, Panel	F	Silver	1.180	0.560	0.090		E1	CP-465	KTH-2001	*	12
KA-19-110	M39012/29-0014	Jack, Crimp, Panel	F	Silver	1.410	0.260			G2	CP-465	KTH-2002	*	12

\*Please Contact Customer Service for Additional Information

KEYED PANEL JACK - K-GRIP, JR.

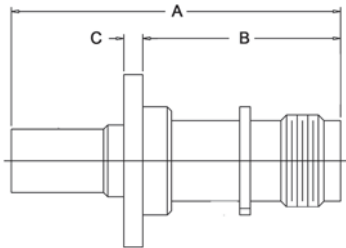


FIGURE 13

Item Number	Military PN	Product Description	Gender	Finish	Dimensions				Cable Group	Cable Procedure	Crimp Die	Mounting Hole	Figure #
					A	B	C	D					
2431-76-1		Jack, Crimp, Panel, W/P, Keyed	F	Nickel	2.030	0.930	0.090		2	CP-5402	KTH-1079	*	13
2431-76-11		Jack, Crimp, Panel, W/P, Keyed	F	Nickel	2.030	0.930	0.090		2	CP-5402	KTH-1079	*	13
2431-76-16		Jack, Crimp, Panel, W/P, Keyed	F	Nickel	2.030	0.930	0.090		2	CP-5402	KTH-1079	*	13
2431-76-6		Jack, Crimp, Panel, W/P, Keyed	F	Nickel	2.030	0.930	0.090		2	CP-5402	KTH-1079	*	13
2431-81-1		Jack, Crimp, Panel, W/P, Keyed	F	Nickel	1.550	0.930	0.090		15	3-546-1	KTH-2214	*	13
2431-81-11		Jack, Crimp, Panel, W/P, Keyed	F	Nickel	1.550	0.930	0.090		15	3-546-1	KTH-2214	*	13
2431-81-16		Jack, Crimp, Panel, W/P, Keyed	F	Nickel	1.550	0.930	0.090		15	3-546-1	KTH-2214	*	13
2431-81-2		Jack, Crimp, Panel, W/P, Keyed	F	Nickel	1.550	0.930	0.090		15	3-546-1	KTH-2214	*	13
2431-81-6		Jack, Crimp, Panel, W/P, Keyed	F	Nickel	1.550	0.930	0.090		15	3-546-1	KTH-2214	*	13
2431-81-9		Jack, Crimp, Panel, W/P, Keyed	F	Nickel	1.550	0.930	0.090		15	3-546-1	KTH-2214	*	13
2431-80-1		Jack, Crimp, Panel, W/P, Keyed	F	Nickel	1.520	0.930	0.090		16	3-546-1	KTH-2161	*	13
2431-80-11		Jack, Crimp, Panel, W/P, Keyed	F	Nickel	1.520	0.930	0.090		16	3-546-1	KTH-2161	*	13
2431-80-16		Jack, Crimp, Panel, W/P, Keyed	F	Nickel	1.520	0.930	0.090		16	3-546-1	KTH-2161	*	13
2431-80-20		Jack, Crimp, Panel, W/P, Keyed	F	Nickel	1.520	0.930	0.090		16	3-546-1	KTH-2161	*	13
2431-80-6		Jack, Crimp, Panel, W/P, Keyed	F	Nickel	1.520	0.930	0.090		16	3-546-1	KTH-2161	*	13
2431-84-1		Jack, Crimp, Panel, W/P, Keyed	F	Nickel	1.520	0.930	0.090		16	3-546-1	KTH-2161	*	13
2431-84-11		Jack, Crimp, Panel, W/P, Keyed	F	Nickel	1.520	0.930	0.090		16	3-546-1	KTH-2161	*	13
2431-84-16		Jack, Crimp, Panel, W/P, Keyed	F	Nickel	1.520	0.930	0.090		16	3-546-1	KTH-2161	*	13
2431-84-2		Jack, Crimp, Panel, W/P, Keyed	F	Nickel	1.520	0.930	0.090		16	3-546-1	KTH-2161	*	13
2431-84-5		Jack, Crimp, Panel, W/P, Keyed	F	Nickel	1.520	0.930	0.090		16	3-546-1	KTH-2161	*	13
2431-85-1		Jack, Crimp, Panel, W/P, Keyed	F	Nickel	1.550	0.930	0.090		17	3-546-1	KTH-2216	*	13
2431-85-11		Jack, Crimp, Panel, W/P, Keyed	F	Nickel	1.550	0.930	0.090		17	3-546-1	KTH-2216	*	13
2431-85-16		Jack, Crimp, Panel, W/P, Keyed	F	Nickel	1.550	0.930	0.090		17	3-546-1	KTH-2216	*	13
2431-85-6		Jack, Crimp, Panel, W/P, Keyed	F	Nickel	1.550	0.930	0.090		17	3-546-1	KTH-2216	*	13
2431-87-1		Jack, Crimp, Panel, W/P, Keyed	F	Nickel	1.550	0.930	0.090		17	3-546-1	KTH-2216	*	13

\*Please Contact Customer Service for Additional Information

Item Number	Military PN	Product Description	Gender	Finish	Dimensions				Cable Group	Cable Procedure	Crimp Die	Mounting Hole	Figure #
					A	B	C	D					
2431-87-11		Jack, Crimp, Panel, W/P, Keyed	F	Nickel	1.550	0.930	0.090		17	3-546-1	KTH-2216	*	13
2431-87-16		Jack, Crimp, Panel, W/P, Keyed	F	Nickel	1.550	0.930	0.090		17	3-546-1	KTH-2216	*	13
2431-87-3		Jack, Crimp, Panel, W/P, Keyed	F	Nickel	1.550	0.930	0.090		17	3-546-1	KTH-2216	*	13
2431-87-6		Jack, Crimp, Panel, W/P, Keyed	F	Nickel	1.550	0.930	0.090		17	3-546-1	KTH-2216	*	13
2431-83-1		Jack, Crimp, Panel, W/P, Keyed	F	Nickel	1.930	0.930	0.090		18	3-546-2	KTH-2212	*	13
2431-83-11		Jack, Crimp, Panel, W/P, Keyed	F	Nickel	1.930	0.930	0.090		18	3-546-2	KTH-2212	*	13
2431-83-16		Jack, Crimp, Panel, W/P, Keyed	F	Nickel	1.930	0.930	0.090		18	3-546-2	KTH-2212	*	13
2431-88-1		Jack, Crimp, Panel, W/P, Keyed	F	Nickel	1.930	0.930	0.090		18	3-546-2	KTH-2212	*	13
2431-88-11		Jack, Crimp, Panel, W/P, Keyed	F	Nickel	1.930	0.930	0.090		18	3-546-2	KTH-2212	*	13
2431-88-16		Jack, Crimp, Panel, W/P, Keyed	F	Nickel	1.930	0.930	0.090		18	3-546-2	KTH-2212	*	13
2431-88-6		Jack, Crimp, Panel, W/P, Keyed	F	Nickel	1.930	0.930	0.090		18	3-546-2	KTH-2212	*	13
2431-89-1		Jack, Crimp, Panel, W/P, Keyed	F	Nickel	2.030	0.930	0.090		19	3-546-2	KTH-2213	*	13
2431-89-11		Jack, Crimp, Panel, W/P, Keyed	F	Nickel	2.030	0.930	0.090		19	3-546-2	KTH-2213	*	13
2431-89-16		Jack, Crimp, Panel, W/P, Keyed	F	Nickel	2.030	0.930	0.090		19	3-546-2	KTH-2213	*	13
2431-89-6		Jack, Crimp, Panel, W/P, Keyed	F	Nickel	2.030	0.930	0.090		19	3-546-2	KTH-2213	*	13
2431-74-1		Jack, Crimp, Panel, W/P, Keyed	F	Nickel	1.520	0.930	0.090		1	CP-465	KTH-2061	*	13
2431-74-11		Jack, Crimp, Panel, W/P, Keyed	F	Nickel	1.520	0.930	0.090		1	CP-465	KTH-2061	*	13
2431-74-16		Jack, Crimp, Panel, W/P, Keyed	F	Nickel	1.520	0.930	0.090		1	CP-465	KTH-2061	*	13
2431-74-2		Jack, Crimp, Panel, W/P, Keyed	F	Nickel	1.520	0.930	0.090		1	CP-465	KTH-2061	*	13
2431-74-3		Jack, Crimp, Panel, W/P, Keyed	F	Nickel	1.520	0.930	0.090		1	CP-465	KTH-2061	*	13
2431-74-4		Jack, Crimp, Panel, W/P, Keyed	F	Nickel	1.520	0.930	0.090		1	CP-465	KTH-2061	*	13
2431-74-6		Jack, Crimp, Panel, W/P, Keyed	F	Nickel	1.520	0.930	0.090		1	CP-465	KTH-2061	*	13
2431-90-1		Jack, Crimp, Panel, W/P, Keyed	F	Nickel	1.460	0.930	0.090		B1	3-546-8	KTH-2081	*	13
2431-90-11		Jack, Crimp, Panel, W/P, Keyed	F	Nickel	1.460	0.930	0.090		B1	3-546-8	KTH-2081	*	13
2431-90-16		Jack, Crimp, Panel, W/P, Keyed	F	Nickel	1.460	0.930	0.090		B1	3-546-8	KTH-2081	*	13
2431-90-6		Jack, Crimp, Panel, W/P, Keyed	F	Nickel	1.460	0.930	0.090		B1	3-546-8	KTH-2081	*	13
2431-91-1		Jack, Crimp, Panel, W/P, Keyed	F	Nickel	1.550	0.930	0.090		89	3-546-1	KTH-2062	*	13
2431-91-11		Jack, Crimp, Panel, W/P, Keyed	F	Nickel	1.550	0.930	0.090		89	3-546-1	KTH-2062	*	13
2431-91-6		Jack, Crimp, Panel, W/P, Keyed	F	Nickel	1.550	0.930	0.090		89	3-546-1	KTH-2062	*	13
2431-82-1		Jack, Crimp, Panel, Iso Grnd, W/P, Keyed	F	Nickel	1.720	1.130	0.090		16	3-546-1	KTH-2161	*	13
2431-82-11		Jack, Crimp, Panel, Iso Grnd, W/P, Keyed	F	Nickel	1.720	1.130	0.090		16	3-546-1	KTH-2161	*	13
2431-82-16		Jack, Crimp, Panel, Iso Grnd, W/P, Keyed	F	Nickel	1.720	1.130	0.090		16	3-546-1	KTH-2161	*	13
2431-82-2		Jack, Crimp, Panel, Iso Grnd, W/P, Keyed	F	Nickel	1.720	1.130	0.090		16	3-546-1	KTH-2161	*	13
2431-82-5		Jack, Crimp, Panel, Iso Grnd, W/P, Keyed	F	Nickel	1.720	1.130	0.090		16	3-546-1	KTH-2161	*	13
2431-82-6		Jack, Crimp, Panel, Iso Grnd, W/P, Keyed	F	Nickel	1.720	1.130	0.090		16	3-546-1	KTH-2161	*	13

\*Please Contact Customer Service for Additional Information

## ANGLE PLUGS - K-GRIP, JR.

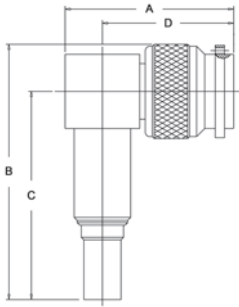


FIGURE 14

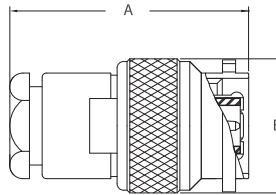


FIGURE 15

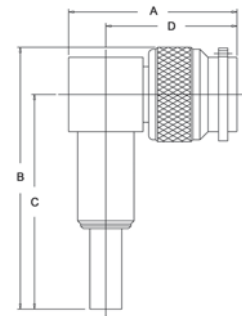


FIGURE 16

Item Number	Military PN	Product Description	Gender	Finish	Dimensions				Cable Group	Cable Procedure	Crimp Die	Mounting Hole	Figure #
					A	B	C	D					
KA-59-189		Plug, Crimp, Angle, W/P	M	Nickel	1.130	1.730	0.640	0.890	45	CP-5401	KTH-2161		14
KA-59-186		Plug, Crimp, Angle, W/P	M	Nickel	1.190	1.900	1.590	0.880	2	CP-5402	KTH-1079		14
126-35-9		Plug, Crimp, Angle, W/P	M	Nickel	1.190	1.870	1.550	0.880	8	3-440-2	KTH-1077		14
126-58-9		Plug, Crimp, Angle, W/P, Hex Nut	M	Nickel	1.130	1.740	1.420	0.880	16	3-546-1	KTH-2161		14
126-71-7		Plug, Crimp, Angle, W/P	M	Nickel	1.130	1.770	1.450	0.880	17	3-546-1	KTH-2216		14
126-71-9		Plug, Crimp, Angle, W/P, Hex Clpg Nut	M	Nickel	1.130	1.770	1.450	0.880	17	3-546-1	KTH-2216		14
126-59-9		Plug, Crimp, Angle, W/P	M	Nickel	1.190	1.870	1.550	0.880	18	3-546-2	KTH-2212		14
126-70-9		Plug, Crimp, Angle, W/P	M	Nickel	3.050	1.810	1.500	2.740	18	3-546-2	KTH-2212		14
126-85-9		Plug, Crimp, Angle, W/P	M	Nickel	1.220	1.920	1.550	0.880	18	3-546-2	KTH-2212		14
126-73-9		Plug, Crimp, Angle, W/P	M	Nickel	1.190	1.960	1.640	0.880	19	3-546-2	KTH-2213		14
126-74-9		Plug, Crimp, Angle, W/P	M	Nickel	1.190	1.960	1.640	0.880	20	3-546-2	KTH-2229		14
KA-59-304		Plug, Crimp, Angle, W/P	M	Nickel	1.130	1.820	1.450	0.890	D	CP-5401	KTH-2061		14
KA-59-439 M06		Plug, Crimp, Angle, W/P	M	Nickel	1.120	1.740	1.420	0.880	E1	CP-5401	KTH-2061		14
126-63-9		Plug, Crimp, Angle, W/P	M	Nickel	1.130	1.740	1.420	0.880	E1	CP-5402	KTH-2061		14
126-64-9		Plug, Crimp, Angle, W/P	M	Nickel	3.050	1.900	1.590	2.740	N3	CP-5402	KTH-2105		14
KA-59-138		Plug, Crimp, Angle	M	Silver	1.250	1.790	0.750	1.490	N1	CP-209A	KTH-2004		15
KA-59-318		Plug, Crimp, Angle	M	Silver	1.250	1.810	0.750	1.490	N1,P	CP-209A	KTH-2004		15
KA-59-96		Plug, Crimp, Angle	M	Nickel	1.220	1.810	0.750	1.490	N1	CP-209A	KTH-2004		15
KA-59-281		Plug, Angle, Preassembled	M	Silver	1.120	1.630	1.320	0.870	B	CP-465	KTH-2011		16
126-8-5	M39012/30-0022	Preassembled	M	Silver	1.120	1.630	1.320	0.870	B1	CP-465	KTH-2011		16
KA-59-70 M06		Plug, Crimp, Angle	M	Nickel	1.040	1.450	1.150	0.850	B1	CP-406	KTH-2032		16
KA-59-295	M39012/30-0502	Plug, Crimp, Angle	M	Silver	1.130	1.790	1.420	0.890	C2	CP-465	KTH-2007		16
KA-59-235	M39012/30-0010	Plug, Crimp, Angle	M	Silver	1.120	1.400	1.080	0.870	D	CP-465	KTH-2001		16
KA-59-297	M39012/30-0504	Plug, Crimp, Angle	M	Silver	1.130	1.790	1.420	0.890	D	CP-465	KTH-2001		16
126-79-5		Plug, Crimp, Angle	M	Silver	1.210	1.850	1.460	0.880	E1	CP-465	KTH-2001		16
KA-59-236	M39012/30-0011	Plug, Crimp, Angle	M	Silver	1.120	1.400	1.080	0.870	E1	CP-465	KTH-2001		16
KA-59-296	M39012/30-0503	Plug, Crimp, Angle	M	Silver	1.130	1.790	1.420	0.890	E1	CP-465	KTH-2001		16
KA-59-72		Plug, Crimp, Angle	M	Silver	1.040	1.630	1.340	0.850	E1	CP-401	KTH-2001		16
KA-59-237	M39012/30-0012	Plug, Crimp, Angle	M	Silver	1.120	1.400	1.080	0.870	G1	CP-465	KTH-2002		16
KA-59-208		Plug, Crimp, Angle	M	Nickel	1.110	1.690	1.390	0.840	M1	CP-416	KTH-2003		16
126-14-5		Plug, Crimp, Angle	M	Nickel	1.190	1.900	1.590	0.880	N3	CP-5402	KTH-2105		16
126-68-5		Plug, Crimp, Angle	M	Silver	1.210	1.870	1.420	0.690		CP-465	KTH-2001		16
126-12-5		Plug, Crimp, Angle	M	Silver	1.130	1.790	1.420	0.880		CP-465	KTH-2007		16
126-86-3		Plug, Crimp, Angle, Hex	M		1.120	1.740	1.420	0.880		CP-465	KTH-2007		16
126-69-5		Plug, Crimp, Angle	M	Silver	1.190	2.510	1.500	0.880		CP-5402	KTH-2012		16

**PLUGS - CONVENTIONAL, K-GRIP**

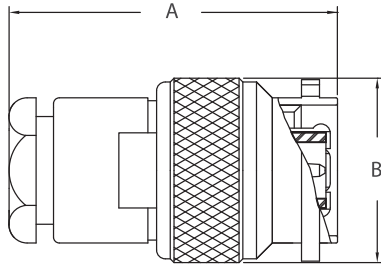


FIGURE 17

**ANGLE PLUG - CONVENTIONAL**

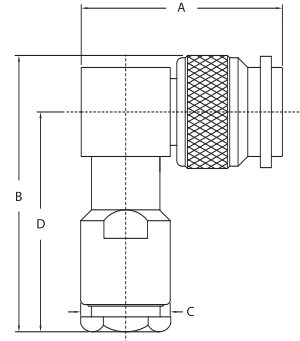


FIGURE 18

**ATTENUATOR**

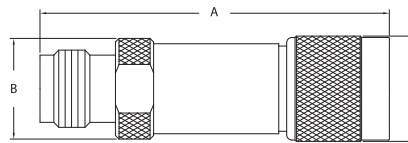


FIGURE 19

Item Number	Military PN	Product Description	Gender	Finish	Dimensions				Cable Group	Cable Procedure	Crimp Die	Mounting Hole	Figure #
					A	B	C	D					
KA-59-289	M39012/26-0013	Plug, Conventional	M	Silver	1.080	0.630			B1	CP-1050			17
KA-51-18		Plug, Conventional	M	Silver	1.090	0.590	0.590		DE	CP-1004			17
KA-59-22	M39012/26-0101	Plug, Conventional	M	Silver	1.080	0.630	0.630		DE	CP-1050			17
125-67-5	M39012/26-0101	Plug, Conventional	M	Silver	1.120	0.630			DE	CP-1050			17
KA-59-18	M39012/26-0102	Plug, Conventional	M	Silver	1.090	0.630			G1	CP-1050			17
KA-51-19		Plug, Conventional	M	Silver	1.670	0.590	0.590		MN	CP-1005			17
125-25-5		Plug, Conventional	M	Silver	1.090	0.640				CP-465			17
KA-59-29		Plug, Crimp	M	Silver	1.180	0.630			D	CP-201A	KTH-2001		17
KA-59-435		Plug, Crimp	M	Nickel	1.690	0.750			N1	CP-230A	KTH-2004		17
KA-59-146		Plug, Crimp	M	Silver	1.680	0.750			N3	CP-209A	KTH-2004		17
KA-59-267		Plug, Crimp	M	Silver	1.690	0.630			P	CP-230A	KTH-2004		17
KA-59-85 M07		Plug, Crimp, Angle, Hex Cplg Nut	M	Silver	1.490	1.250	0.750	0.560	K3	CP-209A	KTH-2012		17
KA-59-348	M39012/30-0118	Plug, Conventional, Angle	M	Silver	1.130	1.560	0.500	1.250	B1	CP-1050			18
KA-59-343	M39012/30-0101	Plug, Conventional, Angle	M	Silver	1.130	1.560	0.500	1.250	DE	CP-1050			18
126-55-5	M39012/30-0101	Plug, Conventional, Angle	M	Silver	1.218	1.750		1.330	DE	3-526			18
126-54-5	M39012/30-0102	Plug, Conventional, Angle	M	Silver	1.218	1.750	0.440	1.330	G1	3-526			18
1800-10		Attenuator	M-F	Nickel	1.950	0.560	0.590						19
1800-11		Attenuator	M-F	Nickel	1.950	0.560	0.590						19
1800-4		Attenuator	M-F	Nickel	1.950	0.560	0.590						19
1800-6		Attenuator	M-F	Nickel	1.950	0.560	0.590						19
1800-7		Attenuator	M-F	Nickel	1.950	0.560	0.590						19

## ANGLE PLUGS - K-GRIP, JR., KEYED

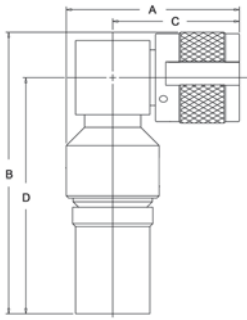


FIGURE 20

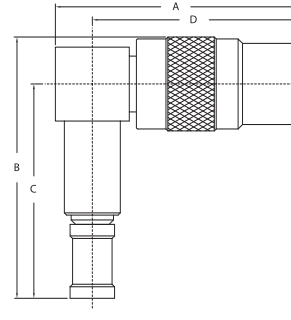


FIGURE 21

## PLUGS - K-GRIP, JR., KEYED

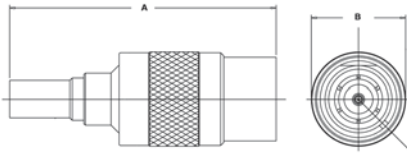


FIGURE 22

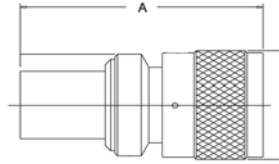


FIGURE 23

Item Number	Military PN	Product Description	Gender	Finish	Dimensions				Cable Group	Cable Procedure	Crimp Die	Mounting Hole	Figure #
					A	B	C	D					
KA-59-324		Plug, Crimp, Angle, W/P, Keyed	M	Silver	1.160	1.900	0.850	1.590	N3	CP-5402	KTH-2105		20
2436-80-1		Plug, Crimp, Angle, W/P, Keyed	M		1.550	1.760	1.450	1.300	1	CP-465	KTH-2061		21
2436-81-1		Plug, Crimp, Angle, W/P, Keyed	M	Nickel	1.600	1.740	1.410	1.350	16	3-546-1	KTH-2161		21
2436-81-11		Plug, Crimp, Angle, W/P, Keyed	M	Nickel	1.600	1.740	1.410	1.350	16	3-546-1	KTH-2161		21
2436-81-16		Plug, Crimp, Angle, W/P, Keyed	M	Nickel	1.600	1.740	1.410	1.350	16	3-546-1	KTH-2161		21
2436-81-2		Plug, Crimp, Angle, W/P, Keyed	M	Nickel	1.600	1.740	1.410	1.350	16	3-546-1	KTH-2161		21
2436-81-21		Plug, Crimp, Angle, W/P, Keyed	M	Nickel	1.600	1.740	1.410	1.350	16	3-546-1	KTH-2161		21
2436-81-6		Plug, Crimp, Angle, W/P, Keyed	M	Nickel	1.600	1.740	1.410	1.350	16	3-546-1	KTH-2161		21
2436-83-1		Plug, Crimp, Angle, W/P, Keyed	M	Nickel	1.660	1.870	1.550	1.350	18	3-546-2	KTH-2212		21
2436-83-11		Plug, Crimp, Angle, W/P, Keyed	M	Nickel	1.660	1.870	1.550	1.350	18	3-546-2	KTH-2212		21
2436-83-16		Plug, Crimp, Angle, W/P, Keyed	M	Nickel	1.660	1.870	1.550	1.350	18	3-546-2	KTH-2212		21
2436-83-24		Plug, Crimp, Angle, W/P, Keyed	M	Nickel	1.660	1.870	1.550	1.350	18	3-546-2	KTH-2212		21
2436-83-6		Plug, Crimp, Angle, W/P, Keyed	M	Nickel	1.660	1.870	1.550	1.350	18	3-546-2	KTH-2212		21
2436-83-9		Plug, Crimp, Angle, W/P, Keyed	M	Nickel	1.660	1.870	1.550	1.350	18	3-546-2	KTH-2212		21
2436-85-1		Plug, Crimp, Angle, W/P, Keyed	M	Nickel	1.660	1.930	1.640	1.350	19	3-546-2	KTH-2213		21
2436-85-6		Plug, Crimp, Angle, W/P, Keyed	M	Nickel	1.660	1.930	1.640	1.350	19	3-546-2	KTH-2213		21
2436-82-1		Plug, Crimp, Angle, W/P, Keyed	M	Silver	1.650	1.900	1.590	1.340	N3	CP-5402	KTH-2105		21
2436-82-10		Plug, Crimp, Angle, W/P, Keyed	M	Silver	1.650	1.900	1.590	1.340	N3	CP-5402	KTH-2105		21
2436-82-5		Plug, Crimp, Angle, W/P, Keyed	M	Silver	1.650	1.900	1.590	1.340	N3	CP-5402	KTH-2105		21
2436-6-3		Plug, Crimp, Angle, Keyed	M		1.540	1.740	1.420	1.290		CP-465	KTH-2007		N/S
126-1-2		Plug, Crimp, Angle, Keyed	M	Silver	1.210	2.000	1.420	0.850	E1	CP-465	KTH-2001		N/S
126-4-1		Plug, Crimp, Angle, Keyed	M	Silver	1.210	2.000	1.420	0.850	C2	CP-465	KTH-2007		N/S
2435-77-1		Plug, Crimp, W/P, Keyed	M	Nickel	2.220	0.640			2	CP-5402	KTH-1079		22
2435-77-11		Plug, Crimp, W/P, Keyed	M	Nickel	2.220	0.640			2	CP-5402	KTH-1079		22
2435-77-16		Plug, Crimp, W/P, Keyed	M	Nickel	2.220	0.640			2	CP-5402	KTH-1079		22
2435-77-6		Plug, Crimp, W/P, Keyed	M	Nickel	2.220	0.640			2	CP-5402	KTH-1079		22

Item Number	Military PN	Product Description	Gender	Finish	Dimensions				Cable Group	Cable Procedure	Crimp Die	Mounting Hole	Figure #
					A	B	C	D					
2435-82-1		Plug, Crimp, W/P, Keyed	M	Nickel	1.800	0.650			15	3-546-1	KTH-2214	22	
2435-82-6		Plug, Crimp, W/P, Keyed	M	Nickel	1.800	0.650			15	3-546-1	KTH-2214	22	
2435-81-1		Plug, Crimp, W/P, Keyed	M	Nickel	1.580	0.650			16	3-546-1	KTH-2161	22	
2435-81-11		Plug, Crimp, W/P, Keyed	M	Nickel	1.580	0.650			16	3-546-1	KTH-2161	22	
2435-81-16		Plug, Crimp, W/P, Keyed	M	Nickel	1.580	0.650			16	3-546-1	KTH-2161	22	
2435-81-2		Plug, Crimp, W/P, Keyed	M	Nickel	1.580	0.650			16	3-546-1	KTH-2161	22	
2435-81-20		Plug, Crimp, W/P, Keyed	M	Nickel	1.580	0.650			16	3-546-1	KTH-2161	22	
2435-81-5		Plug, Crimp, W/P, Keyed	M	Nickel	1.580	0.650			16	3-546-1	KTH-2161	22	
2435-81-6		Plug, Crimp, W/P, Keyed	M	Nickel	1.580	0.650			16	3-546-1	KTH-2161	22	
2435-81-9		Plug, Crimp, W/P, Keyed	M	Nickel	1.580	0.650			16	3-546-1	KTH-2161	22	
2435-84-1		Plug, Crimp, Weatherproof, Keyed	M	Nickel	1.610	0.650			17	3-546-1	KTH-2216	22	
2435-84-11		Plug, Crimp, Weatherproof, Keyed	M	Nickel	1.610	0.650			17	3-546-1	KTH-2216	22	
2435-84-16		Plug, Crimp, Weatherproof, Keyed	M	Nickel	1.610	0.650			17	3-546-1	KTH-2216	22	
2435-84-3		Plug, Crimp, Weatherproof, Keyed	M	Nickel	1.610	0.650			17	3-546-1	KTH-2216	22	
2435-84-5		Plug, Crimp, Weatherproof, Keyed	M	Nickel	1.610	0.650			17	3-546-1	KTH-2216	22	
2435-84-6		Plug, Crimp, Weatherproof, Keyed	M	Nickel	1.610	0.650			17	3-546-1	KTH-2216	22	
2435-83-1		Plug, Crimp, Weatherproof, Keyed	M	Nickel	2.130	0.650			18	3-546-2	KTH-2212	22	
2435-83-11		Plug, Crimp, Weatherproof, Keyed	M	Nickel	2.130	0.650			18	3-546-2	KTH-2212	22	
2435-83-16		Plug, Crimp, Weatherproof, Keyed	M	Nickel	2.130	0.650			18	3-546-2	KTH-2212	22	
2435-83-6		Plug, Crimp, Weatherproof, Keyed	M	Nickel	2.130	0.650			18	3-546-2	KTH-2212	22	
2435-87-1		Plug, Crimp, Weatherproof, Keyed	M	Nickel	2.215	0.650			19	3-546-2	KTH-2213	22	
2435-87-11		Plug, Crimp, Weatherproof, Keyed	M	Nickel	2.215	0.650			19	3-546-2	KTH-2213	22	
2435-87-16		Plug, Crimp, Weatherproof, Keyed	M	Nickel	2.215	0.650			19	3-546-2	KTH-2213	22	
2435-87-6		Plug, Crimp, Weatherproof, Keyed	M	Nickel	2.215	0.650			19	3-546-2	KTH-2213	22	
2435-89-1		Plug, Crimp, Weatherproof, Keyed	M	Nickel	2.330	0.650			20	3-546-2	KTH-2229	22	
2435-89-11		Plug, Crimp, Weatherproof, Keyed	M	Nickel	2.330	0.650			20	3-546-2	KTH-2229	22	
2435-89-16		Plug, Crimp, Weatherproof, Keyed	M	Nickel	2.330	0.650			20	3-546-2	KTH-2229	22	
2435-89-6		Plug, Crimp, Weatherproof, Keyed	M	Nickel	2.330	0.650			20	3-546-2	KTH-2229	22	
2435-74-1		Plug, Crimp, Weatherproof, Keyed	M	Nickel	1.580	0.650			E1	CP-465	KTH-2061	22	
2435-74-11		Plug, Crimp, Weatherproof, Keyed	M	Nickel	1.580	0.650			E1	CP-465	KTH-2061	22	
2435-74-16		Plug, Crimp, Weatherproof, Keyed	M	Nickel	1.580	0.650			E1	CP-465	KTH-2061	22	
2435-74-3		Plug, Crimp, Weatherproof, Keyed	M	Nickel	1.580	0.650			E1	CP-465	KTH-2061	22	
2435-74-6		Plug, Crimp, Weatherproof, Keyed	M	Nickel	1.580	0.650			E1	CP-465	KTH-2061	22	
2435-88-1		Plug, Crimp, W/P, Keyed	M	Nickel	1.580	0.640			89	3-440-3	KTH-2062	22	
2435-88-11		Plug, Crimp, W/P, Keyed	M	Nickel	1.580	0.640			89	3-440-3	KTH-2062	22	
2435-88-16		Plug, Crimp, W/P, Keyed	M	Nickel	1.580	0.640			89	3-440-3	KTH-2062	22	
2435-88-6		Plug, Crimp, W/P, Keyed	M	Nickel	1.580	0.640			89	3-440-3	KTH-2062	22	
125-4-1		Plug, Crimp, Keyed	M	Silver	1.500	0.610			C2	CP-465		N/S	
125-4-2		Plug, Crimp, Keyed	M	Silver	1.500	0.610			C2	CP-465	KTH-2007	N/S	
125-86-1		Plug, Crimp, Keyed	M	Silver	1.240	0.610			D	CP-465	KTH-2001	N/S	
125-1-1		Plug, Crimp, Keyed	M	Silver	1.240	0.610			E1	CP-465	KTH-2001	N/S	
125-1-6		Plug, Crimp, Keyed	M	Silver	1.500	0.610			E1	CP-465	KTH-2001	N/S	
125-52-1		Plug, Crimp, Keyed	M	Silver	2.000	0.610			11	CP-5402	KTH-2012	23	
125-52-2		Plug, Crimp, Keyed	M	Silver	2.000	0.610			11	CP-5402	KTH-2012	23	
125-52-3		Plug, Crimp, Keyed	M	Silver	2.000	0.610			11	CP-5402	KTH-2012	23	
125-52-4		Plug, Crimp, Keyed	M	Silver	2.000	0.610			11	CP-5402	KTH-2012	23	



PLUG - K-GRIP, JR.

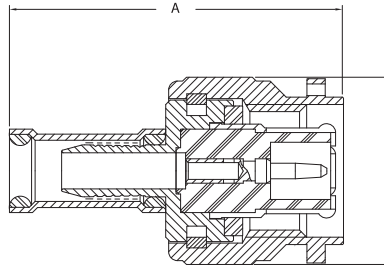


FIGURE 24

Item Number	Military PN	Product Description	Gender	Finish	Dimensions				Cable Group	Cable Procedure	Crimp Die	Mounting Hole	Figure #
					A	B	C	D					
KA-59-167		Plug, Crimp, W/P	M	Nickel	1.110	0.590					KTH-2062		24
KA-59-185		Plug, Crimp, W/P	M	Nickel	1.830	0.630			2	CP-5402	KTH-1079		24
KA-59-185 MC7		Plug, Crimp, W/P	M	Silver	1.830	0.630			2	CP-5402	KTH-1079		24
125-57-9		Plug, Crimp, W/P	M	Nickel	1.740	0.640			8	3-440-2	KTH-1077		24
125-58-9		Plug, Crimp, W/P	M	Nickel	1.140	0.640			10	3-440-3	KTH-2061		24
KA-59-391 M06		Plug, Crimp, W/P	M	Nickel	1.740	0.630			12	CP-5402	KTH-2127		24
125-89-9		Plug, Crimp, W/P	M	Nickel	1.330	0.560			15	3-546-1	KTH-2214		24
125-88-9		Plug, Crimp, W/P	M	Nickel	1.110	0.560			16	3-546-1	KTH-2161		24
125-94-9		Plug, Crimp, W/P	M	Gold	1.110	0.500			16	3-546-1	KTH-2161		24
125-95-7		Plug, Crimp, W/P	M	Nickel	1.140	0.640			17	3-546-1	KTH-2216		24
125-95-9		Plug, Crimp, W/P	M	Nickel	1.140	0.560			17	3-546-1	KTH-2216		24
125-96-9		Plug, Crimp, Weatherproof	M	Gold	1.140	0.500			17	3-546-1	KTH-2216		24
125-101-9		Plug, Crimp, Weatherproof	M	Nickel	1.660	0.560			18	3-546-2	KTH-2212		24
125-117-9		Plug, Crimp, Weatherproof	M	Nickel	1.660	0.760			18	3-546-2	KTH-2212		24
125-91-9		Plug, Crimp, Weatherproof	M	Nickel	1.690	0.560			18	3-546-2	KTH-2212		24
125-92-9		Plug, Crimp, Weatherproof	M	Nickel	2.000	0.640			19	3-546-2	KTH-2213		24
125-105-9		Plug, Crimp, Weatherproof	M	Nickel	1.840	0.640			20	3-546-2	KTH-2229		24
KA-59-260		Plug, Crimp, Weatherproof	M	Nickel	1.040	0.590			B1	CP-402	KTH-2081		24
615-11-9		Plug, Crimp, Weatherproof, 75 Ohm	M	Nickel	1.210	0.570			B2	3-661-4	KTH-2277		24
125-69-9		Plug, Crimp, Weatherproof	M	Nickel	1.110	0.640			C2	CP-5401	KTH-2067		24
KA-59-277		Plug, Crimp, Weatherproof	M	Nickel	1.140	0.630			D	CP-5401	KTH-2061		24
KA-59-438 M06		Plug, Crimp, W/P	M	Nickel	1.110	0.630			E1	CP-465	KTH-2061		24
KA-59-251		Plug, Crimp, W/P	M	Nickel	1.120	0.630			E1	CP-472	KTH-2061		24
125-98-9		Plug, Crimp, W/P, Hex Cplg Nut	M	Nickel	1.110	0.610			E1	CP-5401	KTH-2061		24
KA-59-353 M06		Plug, Crimp, W/P	M	Nickel	1.830	0.630			N3	CP-5402	KTH-2105		24
125-61-9		Plug, Crimp, W/P	M	Nickel	1.250	0.640				CP-402	KTH-2081		24
KA-59-375 M07		Plug, Crimp, W/P	M	Silver	1.110	0.630				CP-465	KTH-2120		24
KA-59-392 M06		Plug, Crimp, W/P	M	Nickel	1.140	0.630				CP-5401	KTH-2128		24
KA-59-188		Plug, Crimp, W/P	M	Nickel	1.100	0.630			45	CP-5401	KTH-2161		24

**PLUG - K-GRIP, JR.**

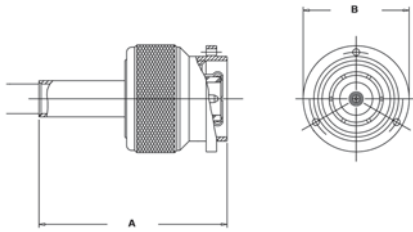


FIGURE 25

**TERMINATION**

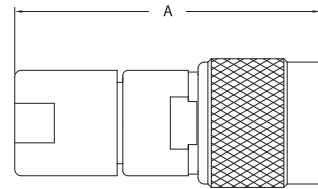


FIGURE 26

**ANGLE RECEPTACLE**

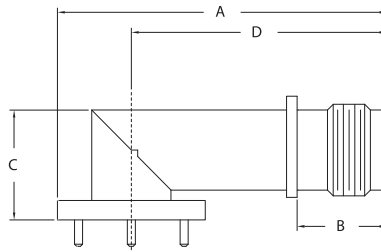


FIGURE 27

Item Number	Military PN	Product Description	Gender	Finish	Dimensions				Cable Group	Cable Procedure	Crimp Die	Mounting Hole	Figure #
					A	B	C	D					
KA-59-290	M39012/26-0501	Plug, Crimp	M	Silver	1.110	0.630			C1	CP-465	KTH-2007		25
125-19-5	M39012/26-0022	Plug, Crimp	M	Silver	1.460	0.640			B1	CP-465	KTH-2011		25
KA-59-69		Plug, Crimp	M	Silver	0.940	0.590			B1	CP-406	KTH-2032		25
KA-59-291	M39012/26-0502	Plug, Crimp	M	Silver	1.110	0.630			C2	CP-465	KTH-2007		25
KA-59-103		Plug, Crimp	M	Nickel	1.100	0.590			D	CP-401	KTH-2001		25
KA-59-220		Plug, Crimp, Polarized	M	Nickel	1.080	0.590			D	CP-401	KTH-2001		25
KA-59-406 M06		Plug, Crimp	M	Nickel	1.100	0.590			D	CP-401	KTH-2001		25
KA-59-231	M39012/26-0010	Plug, Crimp	M	Silver	1.080	0.630			D	CP-465	KTH-2001		25
KA-59-287	M39012/26-0504	Plug, Crimp	M	Silver	1.110	0.630			D	CP-465	KTH-2001		25
125-114-5		Plug, Crimp	M	Silver	1.180	0.640			E1	CP-465	KTH-2001		25
KA-59-230	M39012/26-0011	Plug, Crimp	M	Silver	1.080	0.630			E1	CP-465	KTH-2001		25
KA-59-263		Plug, Crimp	M	Nickel	1.080	0.630			E1	CP-465	KTH-2001		25
KA-59-292	M39012/26-0503	Plug, Crimp	M	Silver	1.110	0.630			E1	CP-465	KTH-2001		25
KA-59-232	M39012/26-0012	Plug, Crimp	M	Silver	1.060	0.630			G1	CP-465	KTH-2002		25
KA-59-279	M39012/26-0021	Plug, Crimp	M	Silver	1.080	0.630			H	CP-465	KTH-2002		25
125-80-9		Plug, Crimp	M	Nickel	1.090	0.590				3-491	KTH-2002		25
128-30-9		Plug, Crimp, W/O Pin	M	Nickel	0.930	0.590				3-491	KTH-2002		25
125-103-5		Plug, Crimp	M	Silver	2.030	0.640				CP-5402	KTH-2012		25
125-104-5		Plug, Crimp	M	Silver	2.030	0.640				CP-5402	KTH-2012		25
KA-89-15		Termination	M	Nickel	1.420								26
127-26-9		Receptacle, PCB, Angle	F	Nickel	1.520	N/A	0.520	0.990					N/S
2437-4-5		Receptacle, PCB, Angle	F	Nickel	1.520	0.431	0.520	1.180					27

## BULKHEAD RECEPTACLES

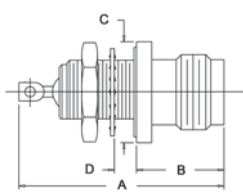


FIGURE 28

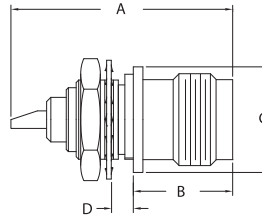


FIGURE 29

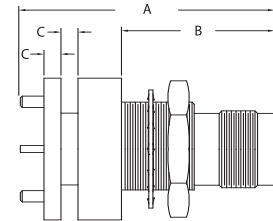


FIGURE 30

## PANEL RECEPTACLES

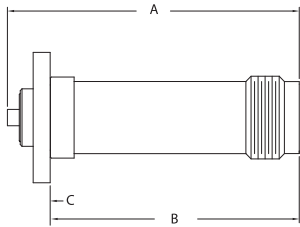


FIGURE 31

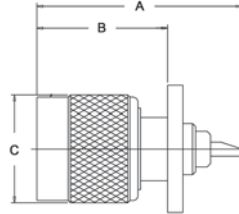


FIGURE 32

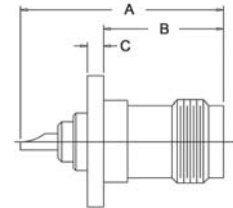


FIGURE 33

Item Number	Military PN	Product Description	Gender	Finish	Dimensions				Cable Group	Cable Procedure	Crimp Die	Mounting Hole	Figure #
					A	B	C	D					
KA-71-04	M39012/34-0002	Receptacle, Bulkhd, Hermetic	F	Silver	1.210	0.520	0.590	0.273			H	28	
KA-79-28		Receptacle, Bulkhead	F	Nickel	1.060	0.470	0.500	0.132			H	29	
KA-79-56		Receptacle, Bulkhead	M	Nickel	1.190	0.670	0.590				H	N/S	
KA-79-59		Receptacle, Iso Ground, Bulkhead	F	Nickel	1.060	0.520	0.560	0.174			X	29	
KA-71-02	M39012/31-0001	Receptacle, Bulkhd	F	Silver	1.050	0.480	0.500	0.135			AB	29	
KA-71-08	M39012/31-0002	Receptacle, Bulkhd	F	Silver	1.190	0.470	0.500	0.260			H	29	
KA-71-03	M39012/34-0001	Receptacle, Bulkhd, Hermetic	F	Silver	1.210	0.830	0.680				X	N/S	
KA-79-165 M06		Receptacle, PCB, Bulkhd	F	Nickel	1.450	0.810	0.090	0.090			X	30	
127-15		Receptacle, Panel	F	Nickel	1.560	1.300	0.090				*	31	
127-19-9		Receptacle, Panel	F	Nickel	1.540	1.310	0.090				*	31	
127-20-9		Receptacle, Panel	F	Nickel	1.600	1.310	0.090				*	31	
KA-79-161 MC9		Receptacle, Panel, Hermetic	F	Gold	0.830	0.530						31	
2437-2-0		Receptacle, Panel	F	Nickel	1.590	1.530	0.110				*	31	
KA-71-09		Receptacle, Panel	M	Silver	1.170	0.750	0.590				*	32	
KA-79-157 M06		Receptacle, Panel	M	Nickel	1.170	0.750	0.090				*	32	
KA-79-118		Receptacle, Panel	F	Nickel	1.060	0.620	0.090				*	33	
KA-79-156 M06		Receptacle, Panel	F	Nickel	0.860	0.430	0.090				*	33	
KA-79-39	M39012/32-0001	Receptacle, Panel	F	Silver	1.060	0.620	0.090				*	33	
K-4944		Body Assembly	M	Nickel	1.080	0.480			E1	CP-5401	KTH-2061	N/S	

\*Please Contact Customer Service for Additional Information

ADAPTERS - WITHIN SERIES

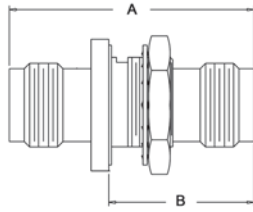


FIGURE 34

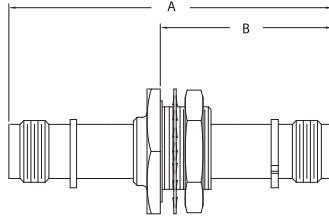


FIGURE 35

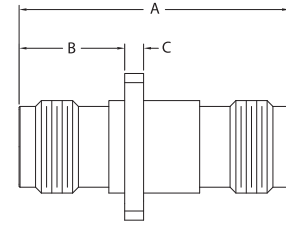


FIGURE 36

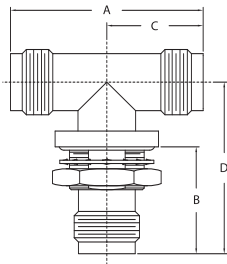


FIGURE 37

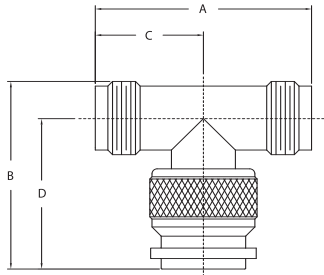


FIGURE 38

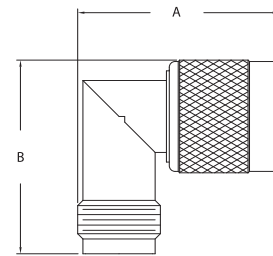


FIGURE 39

Item Number	Military PN	Product Description	Gender	Finish	Dimensions				Cable Group	Cable Procedure	Crimp Die	Mounting Hole	Figure #
					A	B	C	D					
KA-99-56		Within Series Adapter, Bulkhd, Hermetic	F-F	Nickel	1.390	0.730					X	34	
KA-91-02		Within Series Adapter, Bulkhd, Hermetic	F-F	Silver	1.390	0.730					X	34	
KA-99-79		Within Series Adapter, Bulkhd, Iso Grd	F-F	Silver	1.280	0.430	0.630	0.440			X	34	
129-26-9		Within Series Adapter, Bulkhd	F-F	Nickel	1.280	0.812					*	34	
KA-99-114 M06		Within Series Adapter, Bulkhd	F-F	Nickel	1.280	0.730					X	34	
129-29-9		Within Series Adapter, Bulkhd	F-F	Nickel	1.281	0.760					X	34	
2439-5-1		W/I Series Adapt, Bulkhd, Hermetic, Keyed	F-F	Nickel	2.290	1.210					I	35	
2439-5-16		W/I Series Adapt, Bulkhd, Hermetic, Keyed	F-F	Nickel	2.290	0.890					I	35	
2439-5-6		W/I Series Adapt, Bulkhd, Hermetic, Keyed	F-F	Nickel	2.290	1.210					I	35	
2439-6-1		W/I Series Adapt, Bulkhd, Hermetic, Keyed	F-F	Nickel	2.500	1.410					I	35	
2439-5-9		W/I Series Adapt, Bulkhd, Hermetic, Keyed	F-F	Nickel	2.290	1.210					X	35	
2439-6-6		W/I Series Adapt, Bulkhd, Hermetic, Keyed	F-F	Nickel	2.500	1.410					I	35	
2439-6-9		W/I Series Adapt, Bulkhd, Hermetic, Keyed	F-F	Nickel	2.500	1.410					I	35	
129-23-9		Within Series Adapter, Panel	F-F	Nickel	1.280	0.500	0.090				*	36	
2439-1-1		Within Series Adapter, Panel, Keyed	F-F	Nickel	1.870	0.930	0.090				*	N/S	
2439-1-11		Within Series Adapter, Panel, Keyed	F-F	Nickel	1.870	0.930	0.090				*	N/S	
2439-1-16		Within Series Adapter, Panel, Keyed	F-F	Nickel	1.870	0.930	0.090				*	N/S	
2439-1-6		Within Series Adapter, Panel, Keyed	F-F	Nickel	1.870	0.930	0.090				*	N/S	
KA-99-74		Within Series Adapter, Panel	F-F	Nickel	1.280	0.496	0.090				*	36	
129-6	M55339/50-00001	Within Series Adapter, Bulkhd, Tee	F-F-F	Silver	1.280	0.710	0.440	1.140			X	37	
129-6 M06		Within Series Adapter, Bulkhd, Tee	F-F-F	Nickel	1.280	0.710	0.440	1.140			X	37	
129-4	M55339/35-00001	Within Series Adapter, Tee	F-M-F	Silver	1.280	1.110	0.630	0.890				38	
KA-91-16		Within Series Adapter, Tee	F-M-F	Silver	1.280	1.110	0.640	0.890				38	
KA-99-125 M06		Within Series Adapter, Tee	F-M-F	Nickel	1.280	1.110	0.630	0.890				38	
KA-99-98		Within Series Adapter, Tee	M-F-F	Silver	1.530	1.060	0.640	0.760				N/S	
KA-91-15		Within Series Adapter, Angle	M-F	Silver	1.060	1.020						39	
KA-99-65		Within Series Adapter, Angle	M-F	Nickel	1.040	1.060						39	

\* Please Contact Customer Service for Additional Information

## ACCESSORIES

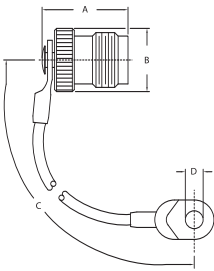


FIGURE 40

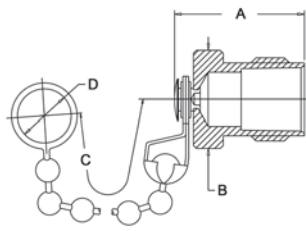


FIGURE 41

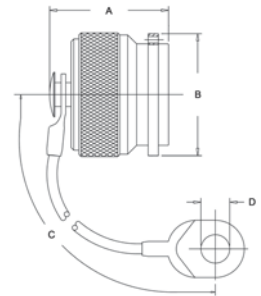


FIGURE 42

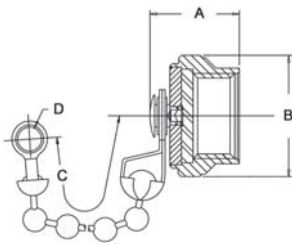


FIGURE 43

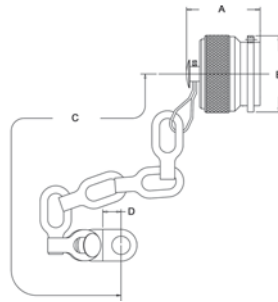


FIGURE 44

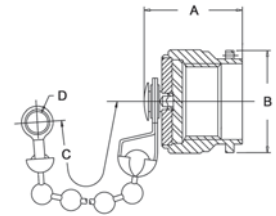


FIGURE 45

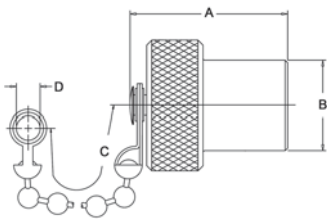


FIGURE 46

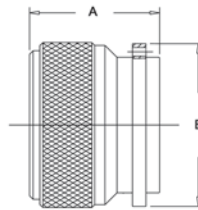


FIGURE 47

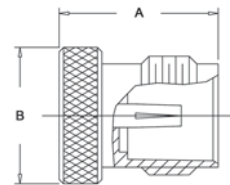
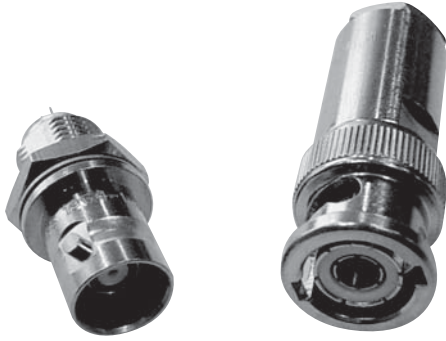


FIGURE 48

Item Number	Military PN	Product Description	Gender	Finish	Dimensions				Cable Group	Cable Procedure	Crimp Die	Mounting Hole	Figure #
					A	B	C	D					
128-17-5		Dust Cap & Rope	F	Silver	0.680	0.500	7.000	0.140					40
128-26-5	M39012/25-0118	Dust Cap & Rope	F	Silver	0.680	0.500	4.000	0.140					40
128-32-9		Dust Cap & Chain	F	Nickel	0.680	0.500	3.250	0.280					41
KA-81-02	M39012/25-0018	Dust Cap & Chain	F	Silver	0.680	0.500	3.000	0.280					41
KA-81-07		Dust Cap & Chain	F	Silver	0.690	0.500	3.730	0.440					41
128-25-5	M39012/25-0120	Dust Cap & Rope	M	Silver	0.710	0.650	4.000	0.140					42
128-31-5		Dust Cap & Chain	M	Silver	0.500	0.630	2.250	0.140					43
128-33-5		Dust Cap & Chain	M	Silver	0.718	0.650	2.500						44
KA-89-82	M39012/25-0021	Dust Cap & Chain	M	Silver	0.718	0.650	0.030	2.700					44
KA-81-05		Dust Cap & Chain	M	Silver	0.550	0.600	2.250	0.140					45
KA-89-18		Dust Cap & Chain	M	Nickel	0.580	0.650	0.144	2.250					45
KA-81-01	M39012/25-0020	Dust Cap & Chain	M	Silver	0.580	0.630	2.250	0.140					45
128-3-5		Dust Cap & Chain	M	Silver	0.950	0.550	2.250						46
KA-81-04		Dust Cap	M	Silver	0.480	0.630							47
KA-81-04 M06		Dust Cap & Chain	M	Nickel	0.480	0.630							47
KA-81-03		Shorting Cap	F	Silver	0.580	0.500							48



- Triaxial version of the popular BNC style connector.
- Miniature size with bayonet coupling.
- 3 Stud design meets MIL-STD-49142.
- Commercial versions also available with 2, 3, or 4 Stud coupling.
- Frequency Range: Up to 500 MHz

**SPECIFICATIONS**

**MATERIAL**

Body:	Brass
Crimp Sleeves: Alloy	Commercial Bronze
Center Contacts:	Brass (Male) Beryllium Copper (Female)
Intermediate Contacts:	Beryllium Copper (Male) Beryllium Copper (Female)
Insulators:	PTFE
Gaskets & Seals:	Silicone Rubber

**FINISHES**

Body:	Silver or Nickel
Center Contacts:	Gold
Intermediate Contacts:	Silver or Gold

**MECHANICAL**

Life:	500 Cycles
Cable Retention:	40 Pounds Minimum

**ELECTRICAL**

Impedance:	Non-Constant
Frequency Range:	DC to 500 MHz
Voltage Rating:	400 Volts RMS
Insulation Resistance:	5000 Megohms
Contact Resistance:	
Center Contact:	2.0 Milliohms
Intermediate & Outer Contacts:	.5 Milliohms

**ENVIRONMENTAL**

Temperature Range:	-65° C to +165° C
Vibration:	MIL-STD-1344, Method 2005.1, Condition III
Shock:	MIL-STD-1344, Method 2004.1, Condition E
Corrosion:	MIL-STD-202, Method 101, Condition B
Moisture Resistance:	MIL-STD-1344, Method 1002

**INTERFACE DIMENSIONS**

Per MIL-C-49142 or MIL-STD-348 as applicable

**TRB PLUG**

Ltr	Inches		Millimeters	
	Min.	Max.	Min.	Max.
A	.123	—	3.12	—
C	Gauge Test			
D	Gauge Test			
E	.385	.390	9.78	9.91
F	.213	.242	5.41	6.15
G	.001	—	0.03	—
H	.007	.033	0.18	0.84
J	.008	.042	0.20	1.07
R	.213	—	5.41	—

**TRB JACK**

Ltr	Inches		Millimeters	
	Min.	Max.	Min.	Max.
A	.414	—	10.52	—
AA	.206	.213	5.23	5.41
B	.204	.208	5.18	5.28
C	.075	.081	1.90	2.06
D	.015	.030	0.38	0.76
F	.117	.122	2.97	3.10
G	.169	.171	4.29	4.34
H	.178	.182	4.52	4.62
J	.195	.199	4.95	5.05
K	.319	.321	8.10	8.15
L	.327	.333	8.31	8.46
M	.346	.356	8.79	9.04
N	.378	.382	9.60	9.70
S	.001	—	0.03	—
T	.327	.335	8.31	8.51
W	.187	.213	4.75	5.41
Y	—	.213	—	5.41
Z	.165	.203	4.19	5.16

# TRB SERIES

## PLUGS

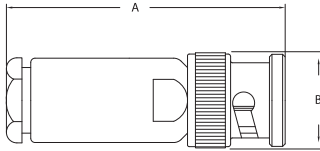


FIGURE 1

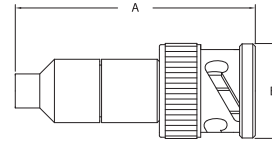


FIGURE 2

## ANGLE PLUG

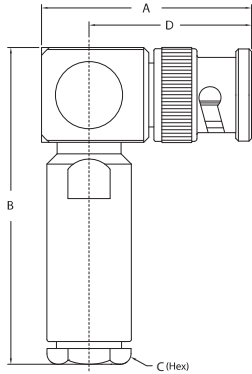


FIGURE 3

## ADAPTER

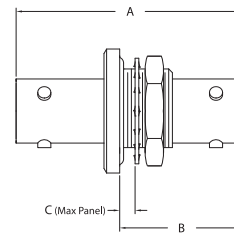


FIGURE 4

## ACCESSORIES

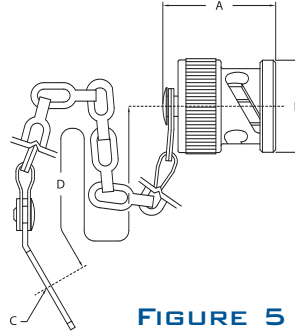


FIGURE 5

Item Number	Military PN	Product Description	Gender	Finish	Dimensions				Cable Group	Cable Procedure	Crimp Die	Mounting Hole	Figure #
					A	B	C	D					
1965-28-5		Plug, Conventional, 2 Stud	M	Silver	1.650	0.560			28	3-392			1
1995-12-5	M49142/03-0004	Plug, Conventional, 3 Stud	M	Silver	1.650	0.560			29	3-392			1
1965-2		Plug, Conventional, 2 Stud	M	Silver	1.460	0.560			46	CP-1301A			1
1965-12-9		Plug, Conventional, 2 Stud	M	Nickel	1.500	0.560			47	CP-1301			1
1995-11-5	M49142/03-0007	Plug, Conventional, 3 Stud	M	Silver	1.710	0.560			P	3-446			1
1965-5-9		Plug, Conventional, 2 Stud	M	Nickel	1.500	0.560			V	CP-1301			1
1995-3-9		Plug, Conventional, 3 Stud	M	Nickel	1.500	0.560			V	CP-1303			1
1995-14-5	M49142/03-0008	Plug, Conventional, 3 Stud	M	Silver	1.520	0.560			W	3-395			1
1995-26-102		Plug, Crimp, 3 Stud	M	Silver	2.000	0.590			W	3-400	KTH-2175		2
1966-6-5		Plug, Conventional, Rt Angle, 2 Stud	M	Silver	1.400	2.100	0.440	0.900	Z	CP-1306			3
1996-14-5		Plug, Conventional, Rt Angle, 3 Stud	M	Silver	1.400	2.100	0.440	0.900	Z	CP-1306			3
1999-1-4		Within Series Adapter, Bulkhd, 3 Stud	F-F	Gold	1.350	0.750	0.163					X	4
1998-2-9		Cap & Chain, 3 Stud	M	Nickel	0.670	0.550	0.520	2.500					5
1998-6-5		Cap & Wire Rope, 3 Stud	M	Nickel	0.670	0.550	0.140	4.000					5

**BULKHEAD JACK**

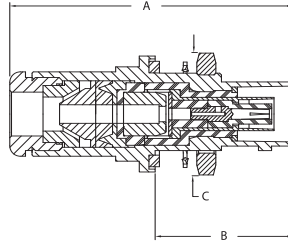


FIGURE 6

**RECEPTACLES**

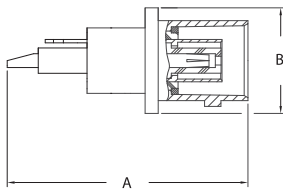


FIGURE 7

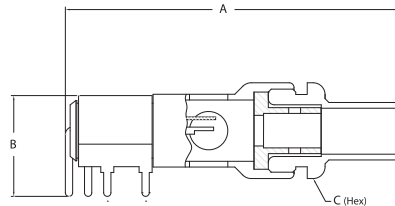


FIGURE 8

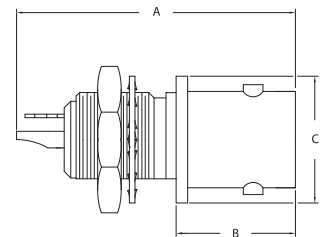


FIGURE 9

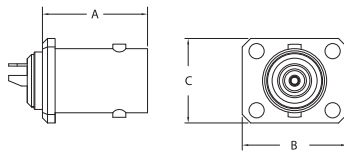


FIGURE 10

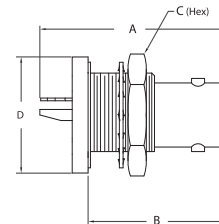
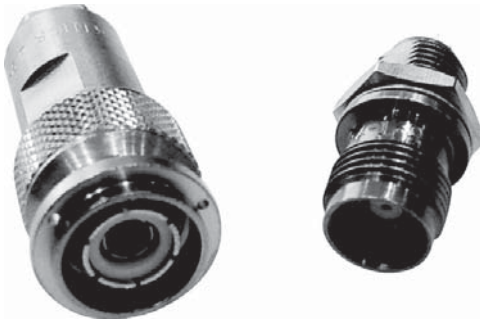


FIGURE 11

Item Number	Military PN	Product Description	Gender	Finish	Dimensions				Cable Group	Cable Procedure	Crimp Die	Mounting Hole	Figure #
					A	B	C	D					
1992-9-5	M49142/05-0004	Jack, Bulkhd, 3 Stud	F	Silver	1.750	0.810	0.630		29	3-392		X	6
1962-2		Jack, Bulkhd, 2 Stud	F	Silver	1.480	0.680	0.630		46	CP-1301A		X	6
1962-7-9		Jack, Bulkhd, 2 Stud	F	Nickel	1.530	0.680	0.630		47	CP-1301		X	6
1992-12-102		Jack, Bulkhd, 3 Stud	F	Nickel	1.530	0.680	0.630		W	3-400	KTH-2175	X	N/S
1994-12-9		Receptacle, 3 Stud	F	Nickel	1.140	0.500				SOLDER			7
1960-1-9		Receptacle, Angle, PCB, 2 Stud	F	Silver	1.760	0.520	0.440			3-734			8
1964-1-9		Receptacle, Bulkhd, Front Mt, 2 Stud	F	Nickel	1.100	0.470	0.500			SOLDER		H	9
1994-1-9		Receptacle, Bulkhd, Front Mt, 3 Stud	F	Nickel	1.140	0.490	0.500			SOLDER		W	9
1967-4-3		Receptacle, Panel, 2 Stud	F	Gold	0.622	0.620	0.500			SOLDER			10
1964-3-9		Receptacle, Bulkhd, Rear Mt, 2 Stud	F	Silver	1.340	0.820	0.630	0.680		SOLDER		X	11
1994-3-5	M49142/04-0004	Receptacle, Bulkhd, Rear Mt, 3 Stud	F	Silver	1.100	0.820	0.630	0.690		SOLDER		X	11
2724-2-5		Receptacle, Bulkhd, Rear Mt, Hermetic, 3 Stud	F	Silver	1.240	0.831	0.625	0.687		SOLDER		X	11
1994-4-5	M49142/04-0005	Receptacle, Bulkhd, Rear Mt, Hermetic, 3 Stud	F	Silver	1.240	1.090	0.630	0.690		SOLDER		X	11
2954-1-5		Receptacle, Bulkhd, Rear Mt, Hermetic, 3 Stud	F	Silver	1.240	0.831	0.625	0.687		SOLDER		X	11
1998-8-5		Receptacle, Bulkhd, Front Mt, Dummy, 3 Stud	F	Silver	0.910	0.500				SOLDER		H	N/S



# TRT SERIES



- Triaxial version of the popular TNC style connector.
- Miniature size with threaded coupling.
- Designed to meet MIL-STD-49142.
- Feature weatherproof taper grip construction, utilizing metal to metal cable clamping.

## SPECIFICATIONS

### MATERIAL

Body:	Brass
Crimp Sleeves:	Commercial Bronze Alloy
Male Center Contacts:	Brass
Female Center Contacts:	Beryllium Copper
Male Intermediate Contacts:	Beryllium Copper
Female Intermediate Contacts:	Beryllium Copper
Insulators:	PTFE
Gaskets & Seals:	Silicone Rubber

### FINISHES

Body:	Silver or Nickel
Center Contacts:	Gold
Intermediate Contacts:	Silver or Gold

### MECHANICAL

Life:	500 Cycles
Cable Retention:	40 Pounds Minimum

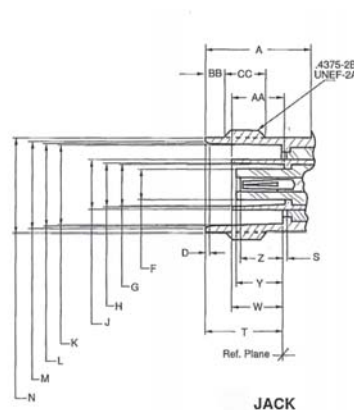
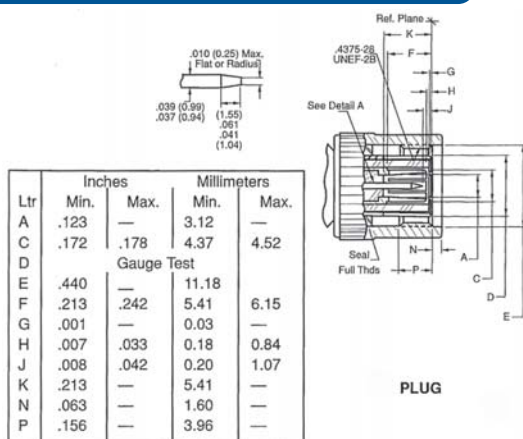
### ELECTRICAL

Impedance:	Non-Constant
Frequency Range:	DC to 500 MHz
Voltage Rating:	400 Volts RMS
Insulation Resistance:	5000 Megohms
Contact Resistance:	
Center Contact:	2.0 Milliohms
Intermediate & Outer Contacts:	.5 Milliohms

### ENVIRONMENTAL

Temperature Range:	-65° C to +165° C
Vibration:	MIL-STD-1344, Method 2005.1, Condition III
Shock:	MIL-STD-1344, Method 2004.1, Condition E
Corrosion:	MIL-STD-202, Method 101, Condition B
Moisture Resistance:	MIL-STD-1344, Method 1002

## INTERFACE DIMENSIONS



**PLUGS**

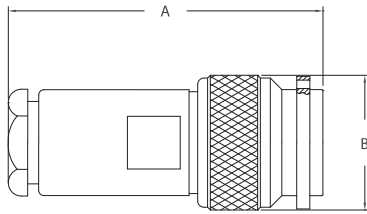


FIGURE 1

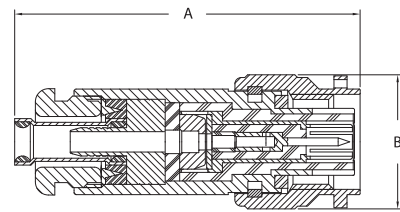


FIGURE 2

**BULKHEAD & PANEL JACKS**

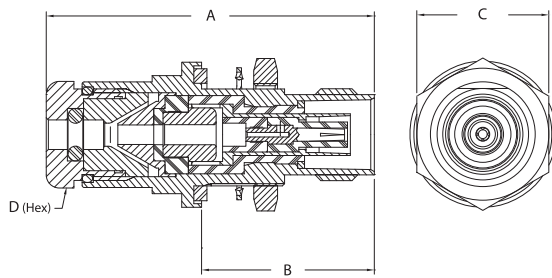


FIGURE 3

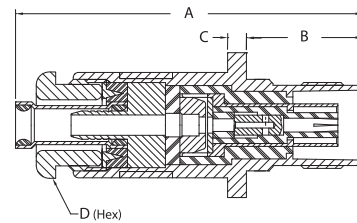


FIGURE 4

**BULKHEAD RECEPTACLES**

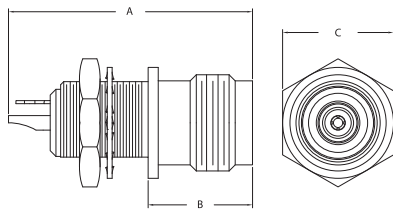


FIGURE 5

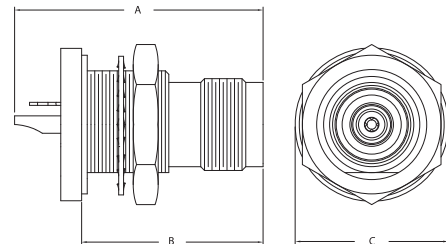
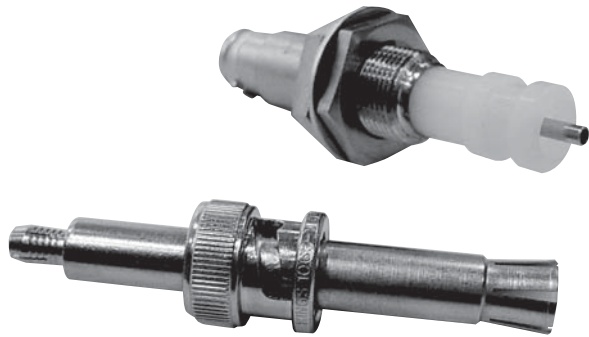


FIGURE 6

Item Number	Military PN	Product Description	Gender	Finish	Dimensions				Cable Group	Cable Procedure	Crimp Die	Mounting Hole	Figure #
					A	B	C	D					
1945-13-5	M49142/08-0002	Plug, Conventional	M	Silver	1.490	0.640			V	3-391			1
1945-19-102		Plug, Crimp	M	Silver	2.000	0.650			W	3-400	KTH-2175		2
1945-35-9		Plug, Crimp	M	Nickel	1.640	0.640			44	3-645	KTH-2120		2
1942-7-5	M49142/09-0006	Jack, Bulkhd	F	Silver	1.750	0.810	0.630	0.440	W	3-395		X	3
1941-6-9		Jack, Panel	F	Nickel	1.640	0.550	0.090	0.440	44	3-645	KTH-2120		4
1944-1-9		Receptacle, Bulkhd, Front Mt	F	Nickel	1.100	0.470	0.500			SOLDER		H	5
1944-3-5	M49142/10-0001	Receptacle, Bulkhd, Rear Mt	F	Silver	1.100	0.820	0.690			SOLDER		X	6
1947-5-9		Receptacle, Bulkhd, Rear Mt	F	Nickel	1.390	0.630				SOLDER		X	6
1944-8-5	M49142/10-0002	Receptacle, Bulkhd, Rear Mt, Hermetic	F	Silver	1.240	0.690	0.264			SOLDER		X	6

## 10 KV SERIES



- Non-constant impedance.
- Ideally suited for pulse applications.
- Durable Brass bodies with Nickel plating.
- Feature polyethylene high density insulators.
- Operating voltage rating of 10 KV DC.

## SPECIFICATIONS

### MATERIAL

Body:	Brass
Crimp Sleeves:	Commercial Bronze Alloy
Male Center Contacts:	Brass
Female Center Contacts:	Beryllium Copper
Outer Contacts:	Beryllium Copper
Insulators:	Polyethylene
Gaskets & Seals:	Silicone Rubber

### FINISHES

Body:	Nickel
Center Contacts:	Gold

### MECHANICAL

Mating:	2 Stud Bayonet Coupling
---------	-------------------------

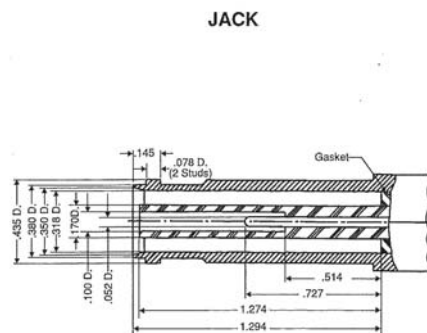
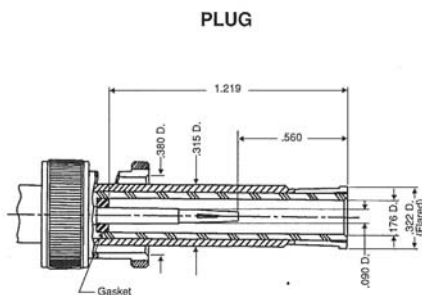
### ELECTRICAL

Impedance:	Non-Constant
Voltage Rating:	Operating: 10 KV DC Test: 15 KV DC
Insulation Resistance:	10 <sup>6</sup> Megaohms

### ENVIRONMENTAL

Temperature Range:	-55° C to +85° C
Polyethylene Insulators	-65° C to +165° C
PTFE Insulators	MIL-STD-202, Method 204, Condition A
Vibration:	MIL-STD-202, Method 213, Condition I
Shock:	MIL-STD-202, Method 101, Condition B
Corrosion:	MIL-STD-202, Method 101, Condition B

## INTERFACE DIMENSIONS



**PLUG - K-GRIP, JR.**

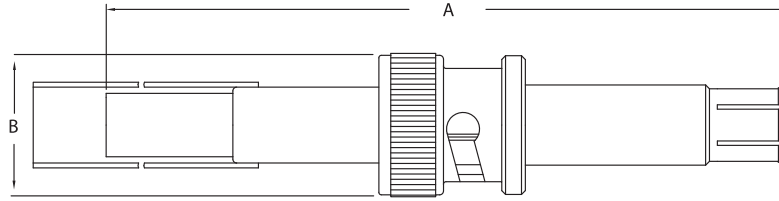


FIGURE 1

**BULKHEAD RECEPTACLE**

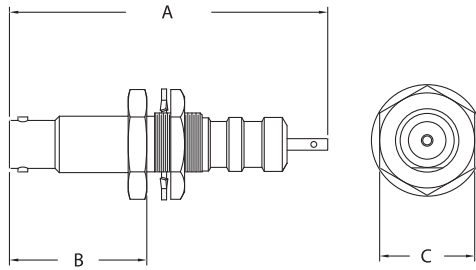


FIGURE 2

**ADAPTER - WITHIN SERIES**

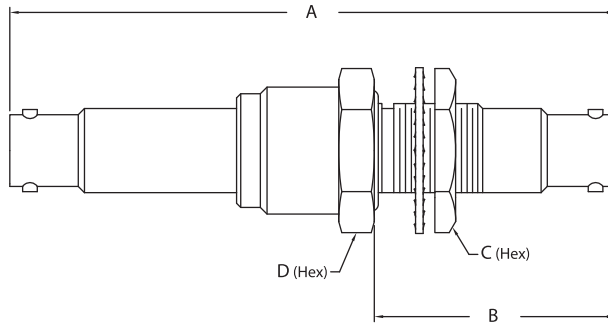


FIGURE 3

Item Number	Military PN	Product Description	Gender	Finish	Dimensions				Cable Group	Cable Procedure	Crimp Die	Mounting Hole	Figure #
					A	B	C	D					
1065-1 QD		Plug, Crimp	M	Nickel	2.710	0.560			D	3-7-1	KTH-2001		1
1065-2		Plug, Crimp	M	Nickel	2.710	0.560			40	CP-419	KTH-2001		1
1064-1 QD		Receptacle, Bulkhd, Front Mt	F	Nickel	2.500	1.080	0.750	0.750		SOLDER		X	2
1069-1		Within Series Adapter, Bulkhd	F-F	Nickel	3.180	1.270	0.750	0.750				X	3

## 20 KV SERIES



- Non-constant impedance.
- Ideally suited for pulse applications.
- Durable Brass bodies with Nickel plating.
- Feature polyethylene high density insulators.
- Operating voltage rating of 20 KV DC.

## SPECIFICATIONS

### MATERIAL

Body:	Brass
Crimp Sleeves:	Commercial Bronze Alloy
Male Center Contacts:	Brass
Female Center Contacts:	Beryllium Copper
Outer Contacts:	Brass
Insulators:	Polyethylene
Gaskets & Seals:	Silicone Rubber

### FINISHES

Body:	Nickel
Center Contacts:	Gold

### MECHANICAL

Mating:	2 Stud Bayonet Coupling
---------	-------------------------

### ELECTRICAL

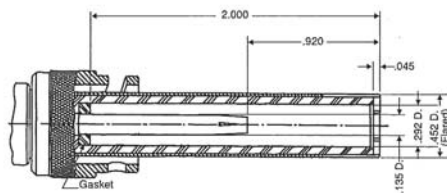
Impedance:	Non-Constant
Voltage Rating:	Operating: 20 KV DC Test: 30 KV DC
Insulation Resistance:	10 <sup>6</sup> Megaohms

### ENVIRONMENTAL

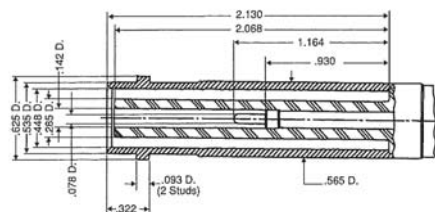
Temperature Range:	
Polyethylene Insulators	-55° C to +85° C
Vibration:	MIL-STD-202, Method 204, Condition A
Shock:	MIL-STD-202, Method 213, Condition I
Corrosion:	MIL-STD-202, Method 101, Condition B

## INTERFACE DIMENSIONS

PLUG



JACK



**PLUG - K-GRIP, JR.**

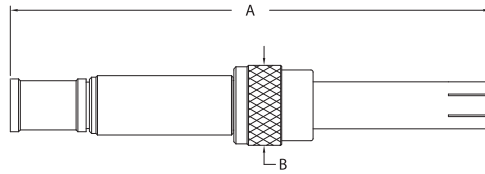


FIGURE 1

**BULKHEAD RECEPTACLE**

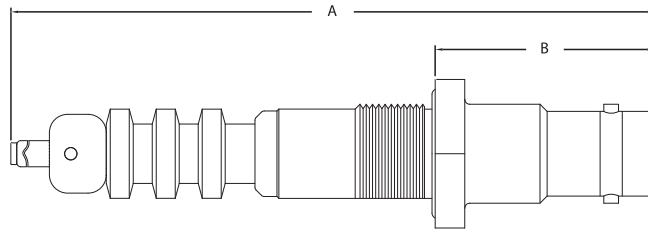


FIGURE 2

Item Number	Military PN	Product Description	Gender	Finish	Dimensions				Cable Group	Cable Procedure	Crimp Die	Mounting Hole	Figure #
					A	B	C	D					
1765-1		Plug, Crimp	M		4.520	0.750			M	3-7-2	KTH-1078		1
1764-2		Receptacle, Bulkhd, Front Mt	F		4.390	1.390				SOLDER		Y	2
1764-1		Receptacle, Bulkhd, Front Mt	F		3.910	1.390				SOLDER		I	2

# HN SERIES



- 50 Ohm Nominal Impedance.
- Standard size connector with threaded coupling.
- High-voltage version of the Type N connector.
- Overlapping dielectric interface with weatherproof features.
- Frequency Range: Up to 4 GHz

## SPECIFICATIONS

### MATERIAL

Body:	Brass
Crimp Sleeves:	Commercial Bronze Alloy
Male Center Contacts:	Brass
Female Center Contacts:	Beryllium Copper
Male Outer Contacts:	Brass
Insulators:	PTFE or Rexolite®
Gaskets & Seals:	Silicone Rubber

### FINISHES

Body:	Silver or Nickel
Center Contacts:	Gold or Silver

### ELECTRICAL

Impedance:	50 Ohms
Frequency Range:	DC to 4 GHz
Voltage Rating:	1500 Volts RMS
Insulation Resistance:	5000 Megohms

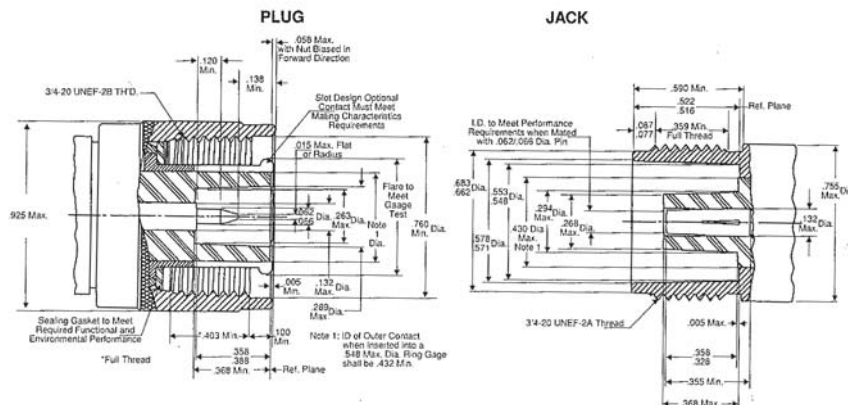
### MECHANICAL

Mating:	3/4 - 20 Threaded Coupling
---------	----------------------------

### ENVIRONMENTAL

Temperature Range:	PTFE Insulator: -65° C to +165° C Rexolite Insulator: -55° C to +85° C
Corrosion:	MIL-STD-202, Method 101, Condition B

## INTERFACE DIMENSIONS



**PLUG - K-GRIP, JR.**

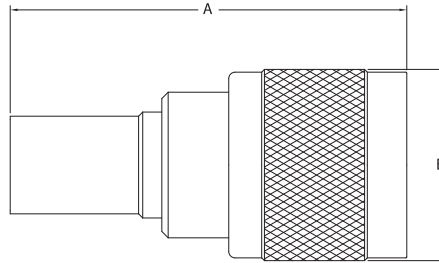


FIGURE 1

**ANGLE PLUG - K-GRIP, JR.**

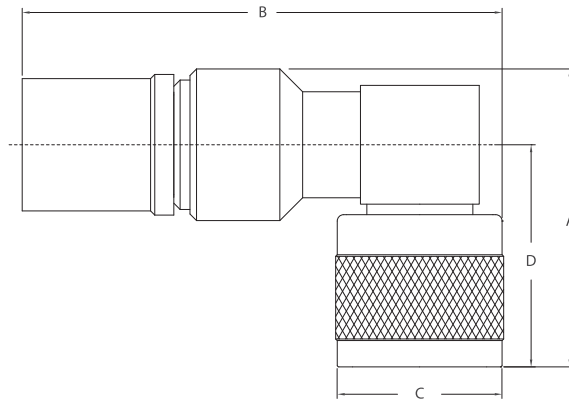


FIGURE 2

Item Number	Military PN	Product Description	Gender	Finish	A	Dimensions B	C	D	Cable Group	Cable Procedure	Crimp Die	Mounting Hole	Figure #
KH-59-05		Plug, Conventional	M	Silver	1.610	0.880			G1	CP-1021.3			N/S
KH-59-72		Plug, Conventional	M	Silver	1.625	0.500			DE	CP-1004			N/S
UG-59 E/U		Plug, Conventional	M	Silver	2.218	0.875			MN	60D-5			N/S
KH-59-78		Plug, Conventional/Crimp	M	Silver	2.230	0.450			N1	CP-239A	KTH-2004		N/S
845-10-9		Plug, Crimp, Weatherproof	M	Nickel	1.930	0.890			19	3-546-2	KTH-2213		1
845-13-9		Plug, Crimp, Weatherproof	M	Nickel	1.830	0.890			18	3-546-4	KTH-2212		1
845-9-9		Plug, Crimp, Weatherproof	M	Nickel	1.890	0.890			20	3-546-2	KTH-2229		1
KH-59-63		Plug, Crimp, Weatherproof	M	Nickel	1.930	0.880			M1	CP-5403	KTH-1078		1
KH-59-65		Plug, Crimp, Weatherproof	M	Nickel	1.930	0.880			N1	CP-5403	KTH-1079		1
KH-59-26		Plugs, Rt Angle, Conventional	M	Silver	1.560	2.370	0.750	1.190	MN	60D-5			N/S
KH-59-84		Plugs, Rt Angle, Conventional	M	Silver	1.540	2.380	0.750	1.190	N3	CP-1031			N/S
846-5-9		Plugs, Rt Angle, Crimp, Weatherproof	M	Nickel	1.510	2.250	0.880	1.190	18	3-546-7	KTH-2212		2
846-7-9		Plugs, Rt Angle, Crimp, Weatherproof	M	Nickel	1.550	2.310	0.880	1.190	20	3-546-2	KTH-2229		2
KH-59-24		Plugs, Rt Angle, Crimp	M	Silver	1.500	2.810	0.750	1.180	N1	CP-208A	KTH-2004		N/S
KH-59-64		Plugs, Rt Angle, Crimp, Weatherproof	M	Nickel	1.500	2.400	0.880	1.190	M1	CP-5403	KTH-1078		2
KH-59-66		Plugs, Rt Angle, Crimp, Weatherproof	M	Nickel	1.500	2.400	0.690	1.190	2	CP-5403	KTH-1079		2



## ADAPTERS

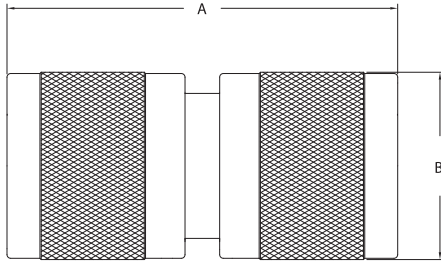


FIGURE 3

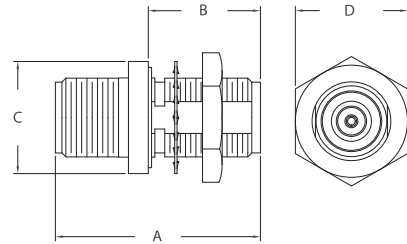


FIGURE 4

## JACKS, RECEPTACLES, & ACCESSORIES

Item Number	Military PN	Product Description	Gender	Finish	Dimensions				Cable Group	Cable Procedure	Crimp Die	Mounting Hole	Figure #
					A	B	C	D					
KH-99-10		Within Series Adapter	M-M	Silver	1.850	0.880							3
849-5-9		Within Series Adapter, Bulkhead, Hermetic	F-F	Nickel	1.930	1.060	1.060	1.060				Z	4
KH-39-11		Jack, Conventional/Crimp	F	Silver	2.050	0.750			M1	CP-208A	KTH-2003		N/S
KH-39-12		Jack, Conventional/Crimp	F	Silver	2.040	0.750			N1	CP-208A	KTH-2004		N/S
KH-39-25 M06		Jack, Crimp, Weatherproof	F	Nickel	1.910	0.750			12	CP-5403	KTH-2127		N/S
KH-79-15		Receptacle, Bulkhead	F	Nickel	1.720	1.060	1.130			SOLDER			N/S
UG-496/U		Receptacle, Panel	F	Silver	1.530	1.180				SOLDER			N/S
848-3-5		Dust Cap & Chain	M	Silver	0.560	0.875	3.250						N/S



- 5 KV voltage rating.
- Non-constant impedance.
- Quick connect & disconnect bayonet coupling.
- Originally designed for high-voltage BNC applications.
- Meet the requirements of MIL-PRF-39012.

**SPECIFICATIONS**

MATERIAL

Body:	Brass
Crimp Sleeves:	Commercial Bronze Alloy
Male Center Contacts:	Brass
Female Center Contacts:	Beryllium Copper
Outer Contacts:	Brass
Insulators:	PTFE
Gaskets & Seals:	Silicone Rubber

FINISHES

Body:	Silver
Center Contacts:	Gold

ELECTRICAL

Impedance:	Non-Constant
Voltage Rating:	Operating: 3500 VRMS Test: 5000 VRMS
Insulation Resistance:	5000 Megohms

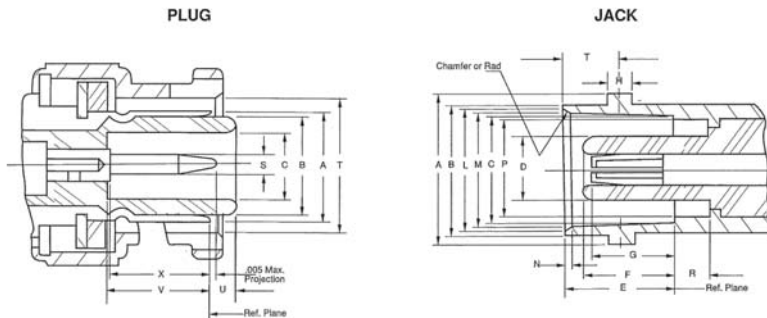
MECHANICAL

Mating:	2 Stud Bayonet Coupling
---------	-------------------------

ENVIRONMENTAL

Temperature Range:	-65° C to +165° C
Vibration:	MIL-STD-202, Method 204, Condition A
Shock:	MIL-STD-202, Method 213, Condition I
Corrosion:	MIL-STD-202, Method 101, Condition B

**INTERFACE DIMENSIONS**



Plug

Dim	Inches (mm)	
	Minimum	Maximum
Ltr		
A	Gauge Test	
B	.278 (7.06)	.282 (7.16)
C	.190 (4.83)	.194 (4.93)
S	.052 (1.32)	.054 (1.37)
T	.385 (9.78)	.390 (9.91)
U		.086 (2.18)
V	.302 (7.67)	
X	.300 (7.62)	
Z	.045 (1.14)	.049 (1.24)

Jack

Dim	Inches (mm)	
	Minimum	Maximum
Ltr		
A	.432 (10.97)	.436 (11.07)
B	.378 (9.60)	.382 (9.70)
C	.319 (8.10)	.321 (8.15)
D		.186 (4.72)
E	.327 (8.31)	.335 (8.51)
F	.289 (7.34)	.311 (7.90)
G	.253 (6.43)	.280 (7.11)
H	.075 (1.91)	.081 (2.06)
L	.346 (8.79)	.356 (9.04)
M	.327 (8.31)	.333 (8.46)
N	.015 (0.38)	.030 (0.76)
P	.284 (7.21)	.290 (7.37)
R	.086 (2.18)	
T	.165 (4.19)	.169 (4.29)

## PLUG - CONVENTIONAL

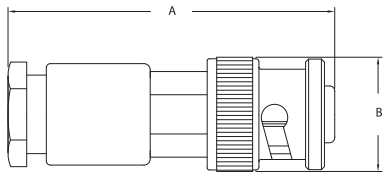


FIGURE 1

## PLUG - K-GRIP, JR.

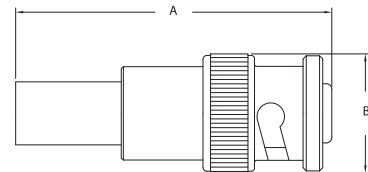


FIGURE 2

## ADAPTERS - WITHIN SERIES

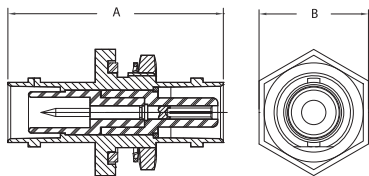


FIGURE 3

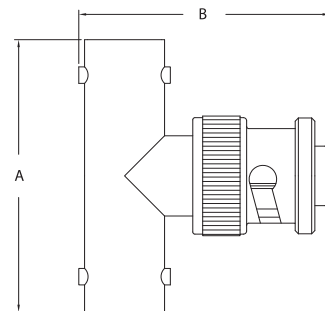
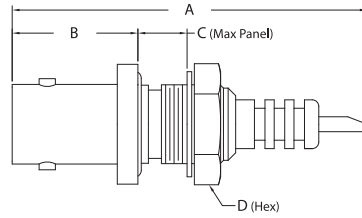


FIGURE 4

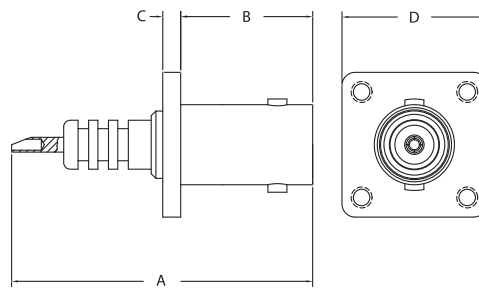
Item Number	Military PN	Product Description	Gender	Finish	Dimensions				Cable Group	Cable Procedure	Crimp Die	Mounting Hole	Figure #
					A	B	C	D					
1685-2-5		Plug, Conventional	M	Silver	1.560	0.560			G1	CP-1002			1
KV-59-04		Plug, Conventional	M	Silver	1.560	0.560			DE	CP-1002			1
KV-59-26		Plug, Conventional	M	Nickel	1.560	0.560			G1	CP-1002			1
KV-59-70		Plug, Conventional	M	Nickel	1.540	0.560			B1	CP-1002			1
KV-59-56		Plug, Conventional, Polarized	M	Silver	1.630	0.560			DE	CP-1002			1
KV-59-23		Plug, Crimp	M	Nickel	1.500	0.560			G1	CP-417	KTH-2002		2
KV-59-37		Plug, Crimp	M	Nickel	1.500	0.560			D	CP-417	KTH-2001		2
KV-99-45		W/I Series, Bkhd, Polarized to Stand	F-F	Silver	1.360	0.690						X	3
KV-99-46		Within Series Adapter, Tee	F-M-F	Nickel	1.280	1.140							4

**BULKHEAD RECEPTACLE**



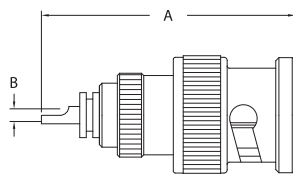
**FIGURE 5**

**PANEL RECEPTACLE**



**FIGURE 6**

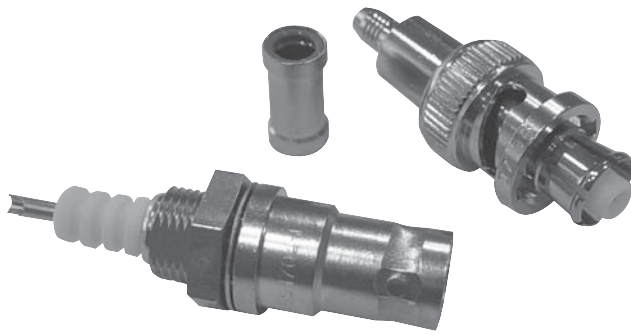
**RECEPTACLE - OTHER**



**FIGURE 7**

Item Number	Military PN	Product Description	Gender	Finish	Dimensions				Cable Group	Cable Procedure	Crimp Die	Mounting Hole	Figure #
					A	B	C	D					
KV-79-11		Receptacle, Bulkhd, Front Mt	F	Silver	1.420	0.470	0.112			SOLDER			5
KV-79-15		Receptacle, Bulkhd, Front Mt	F	Nickel	1.690	0.590	0.234			SOLDER		AA	5
KV-79-12		Receptacle, Panel	F	Nickel	1.430	0.630	0.085	0.690		SOLDER			6
KV-79-21		Receptacle	M	Nickel	1.190	0.060				SOLDER			7

# SHV SERIES



- 5 KV voltage rating.
- Non-constant impedance.
- Quick connect & disconnect bayonet coupling design.
- Outer contact ground connection is maintained through the center contact mating cycle.
- Recessed center contacts prevent shock hazards while unmated.

## SPECIFICATIONS

### MATERIAL

Body:	Brass
Crimp Sleeves:	Commercial Bronze Alloy
Male Center Contacts:	Brass
Female Center Contacts:	Beryllium Copper
Outer Contacts:	Beryllium Copper
Insulators:	PTFE or Rexolite®
Gaskets & Seals:	Silicone Rubber

### FINISHES

Body:	Nickel
Center Contacts:	Gold

### ELECTRICAL

Impedance:	Non-Constant
Voltage Rating:	Operating: 3500 VRMS Test: 5000 VRMS
Insulation Resistance:	10 <sup>6</sup> Megaohms

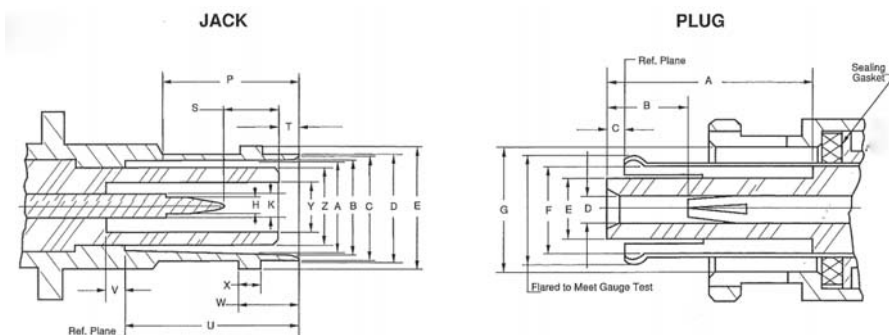
### MECHANICAL

Mating: 2 Stud Bayonet Coupling

### ENVIRONMENTAL

Temperature Range:	PTFE -65° C to +165° C Rexolite® -55° C to +85° C
Vibration:	MIL-STD-202, Method 204, Condition A MIL-STD-202, Method 213, Condition I
Shock:	MIL-STD-202, Method 101, Condition B
Corrosion:	

## INTERFACE DIMENSIONS



Jack

Dim	Inches		Millimeters	
	Min	Max	Min	Max
A	.319	.321	8.10	8.15
B	.328	.333	8.33	8.46
C	.347	.357	8.81	9.07
D	.378	.382	9.60	9.70
E	.432	.436	10.97	11.07
H	.052	.054	1.32	1.37
K	.081	.083	2.06	2.11
P	.427		10.85	
S	.188	.208	4.78	5.28
T	.061	.078	1.55	1.98
U	.626	.630	15.90	16.00
V	.064	.086	1.63	2.18
W	.204	.208	5.18	5.28
X	.075	.081	1.90	2.06
Y	.190	.196	4.83	4.98
Z		.280		6.80

Plug

Dim	Inches		Millimeters	
	Min	Max	Min	Max
A	.628	.632	15.95	16.05
B	.238	.262	6.05	6.65
C	.046	.064	1.17	1.63
D	.082		2.08	
E	.180	.186	4.57	4.72
F	.264		6.71	
G	.385	.390	9.78	9.91

**BULKHEAD RECEPTACLES**

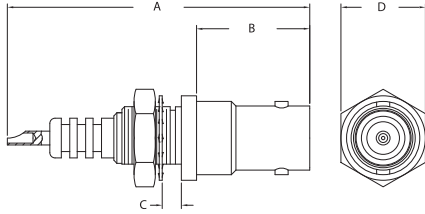


FIGURE 1

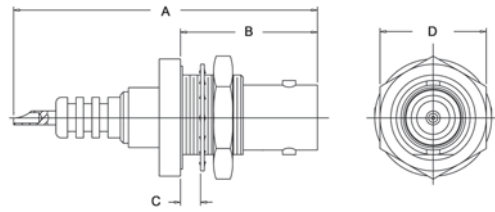


FIGURE 2

**ADAPTERS - WITHIN SERIES**

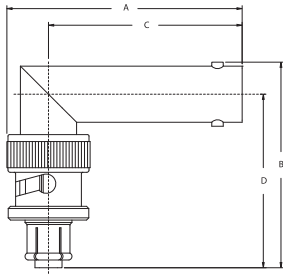


FIGURE 3

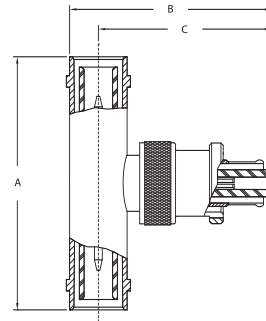


FIGURE 4

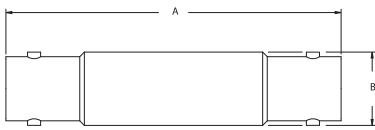


FIGURE 5

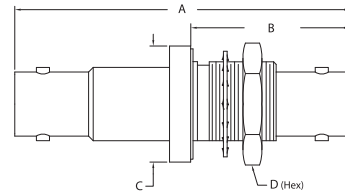


FIGURE 6

Item Number	Military PN	Product Description	Gender	Finish	Dimensions				Cable Group	Cable Procedure	Crimp Die	Mounting Hole	Figure #
					A	B	C	D					
1704-1 QD		Receptacle, Bulkhd, Front Mt, PTFE Insl	F	Nickel	1.790	0.670	0.182	0.500		SOLDER		H	1
1704-3-9		Receptacle, Bulkhd, Front Mt	F	Nickel	1.780	0.670	0.182	0.500		SOLDER			1
1704-1-11 M06		Recept, Bulkhd, Front Mt, Rexolite Insl	F	Nickel	1.780	0.670	0.182	0.500		SOLDER		H	1
1704-2		Receptacle, Bulkhd, Rear Mt	F	Nickel	1.790	0.810	0.235	0.630		SOLDER		X	2
1709-12 M06		Within Series Adapter, Rt Angle	F-M	Nickel	1.590	1.390	1.310	1.170					3
1709-3		Within Series Adapter, Tee	M-F-M	Nickel	1.710	1.370	1.170						4
1709-5		Within Series Adapter	F-F	Nickel	1.990	0.440							5
1709-1		Within Series Adapter, Bulkhd, PTFE Insl	M-M	Nickel	1.990	0.950	0.690	0.630				X	6
1709-1-11		Within Series Adapter, Bulkhd, Rexolite Insl	M-M	Nickel	1.990	0.950	0.690	0.630				X	6
1709-2		Within Series Adapter, Bulkhd, Hermetic	F-F	Nickel	2.250	1.150	0.690	0.630				X	6

# SHV SERIES

## PLUGS - K-GRIP, JR.

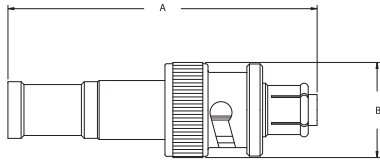


FIGURE 7

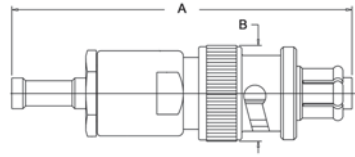


FIGURE 8

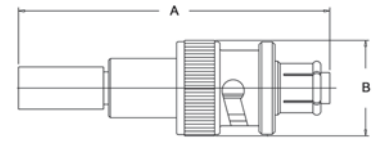


FIGURE 9

## PLUG - CONVENTIONAL

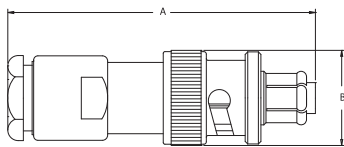


FIGURE 10

## BULKHEAD JACK - K-GRIP, JR.

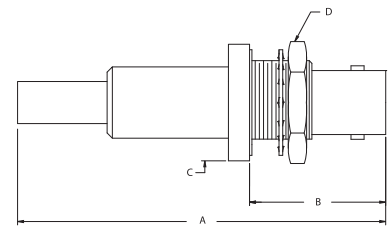


FIGURE 11

## PANEL RECEPTACLE

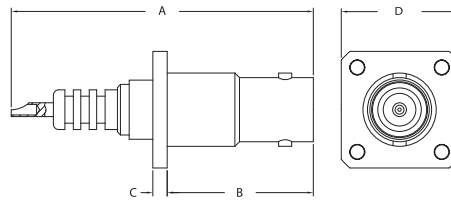


FIGURE 12

Item Number	Military PN	Product Description	Gender	Finish	A	Dimensions B	C	D	Cable Group	Cable Procedure	Crimp Die	Mounting Hole	Figure #
1705-1		Plug, Weatherproof Crimp, PTFE Insl	M	Nickel	1.830	0.560			G1	CP-441	KTH-2062		7
1705-2		Plug, Weatherproof Crimp, PTFE Insl	M	Nickel	1.750	0.560			D	CP-441	KTH-2061		7
1705-2-1		Plug, Weatherproof Crimp, Rexolite Insl	M	Nickel	1.730	0.560			D	CP-441	KTH-2061		7
1705-21-9		Plug, Weatherproof Crimp, 6KV	M	Nickel	1.710	0.560			G1	CP-441	KTH-2062		7
1705-4		Plug, Weatherproof Crimp	M	Nickel	2.140	0.630			N1	CP-457	KTH-1079		7
1705-3		Plug, Weatherproof Crimp	M	Nickel	2.010	0.560			B1	CP-447	KTH-2071		8
1705-16 M06		Plug, Crimp, PTFE Insl	M	Nickel	1.790	0.560			40	CP-441	KTH-2001		9
1705-16-11		Plug, Crimp, Rexolite Insl	M	Nickel	1.770	0.560			40	CP-441	KTH-2001		9
1705-14		Plug, Conventional	M	Nickel	1.810	0.560			G1	CP-1001.3			10
1702-1		Jack, Bulkhd, Rear Mt	F	Nickel	2.200	0.810	0.690	0.630	G1	CP-441	KTH-2062	X	11
1702-2		Jack, Bulkhd, Rear Mt	F	Nickel	2.200	0.810	0.690	0.630	D	CP-441	KTH-2061	X	11
1702-4-11		Jack, Bulkhd, Rear Mt	F	Nickel	2.200	0.810	0.690	0.630	40	CP-441	KTH-2001	X	11
1707-1		Receptacle, Panel	M	Nickel	1.790	0.870	0.090	0.690		SOLDER			12



- 75 Ohm performance suitable for Analog, Serial Digital and HDTV applications.
- Meets or exceeds SMPTE 292 requirements.
- Several configurations available to fit a variety of cables.
- Simple, full crimp design for easy field installation.
- Quick connect and disconnect with Bayonet coupling.
- A Mini BNC version is also available - contact Customer Service for additional information.

**SPECIFICATIONS**

MATERIAL

Body: Brass  
 Outer Contact: Beryllium Copper  
 Insulator: PTFE  
 K-Grip Sleeve: Commercial Bronze

FINISHES

Body: Nickel  
 Contacts: Gold

ELECTRICAL

Impedance: 75 Ohms  
 Voltage Rating: 500 Volts RMS  
 Return Loss: Up to 1 GHz, -36 dB min  
 Up to 2 GHz, -25 dB min  
 Up to 3 GHz, -23 dB min  
 Up to 4 GHz, -20 dB min

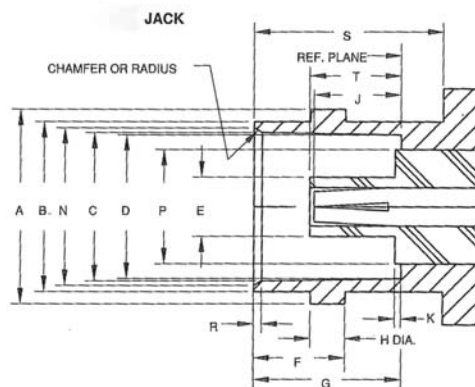
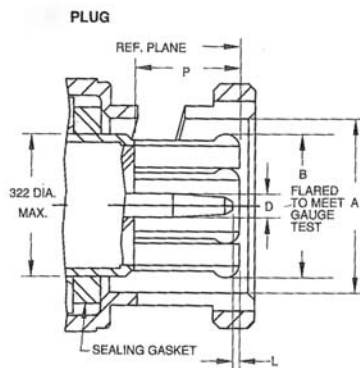
MECHANICAL

Life: 500 cycles minimum  
 Cable Retention: 10 lbs to 40 lbs, Depending on Cable Size  
 Engagement Force: 2.5 lbs maximum, Torque  
 3.0 lbs maximum, Longitudinal

ENVIRONMENTAL

Temperature: -65°C to +165°C  
 Moisture: 0 to 95%  
 MIL-STD-202 Method 106  
 Corrosion: MIL-STD-202 Method 101,  
 Test Condition B  
 Flammability: UL 94-VO Rated  
 Vibration: MIL-STD-202 Method 204,  
 Test Condition B

**INTERFACE DIMENSIONS**



Dim. Ltr.	Min.	Max.	Dim. Ltr.	Min.	Max.
A	.432 (10.97)	.436 (11.07)	H	.075 (1.91)	.081 (2.06)
B	.378 (9.60)	.382 (9.70)	J	.186 (4.72)	.206 (5.23)
C	.327 (8.31)	.333 (8.46)	K		.006 (0.15)
D	.319 (8.10)	.321 (8.15)	N	.346 (8.79)	.356 (9.04)
E 75ohm	.128 (3.25)	.136 (3.45)	R	.015 (0.38)	.030 (0.76)
F	.204 (5.18)		S	.414 (10.52)	
G	.327 (8.31)		T	.188 (4.78)	.208 (5.28)

Dimensions in inches with metric equivalents (mm) in parentheses.



## ADAPTERS

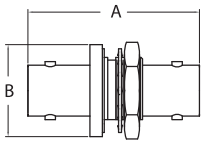


FIGURE 1

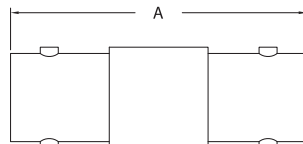


FIGURE 2

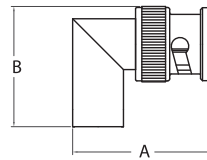


FIGURE 3

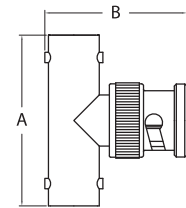


FIGURE 4

## TERMINATION

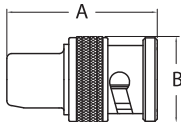


FIGURE 5

## BULKHEAD JACK

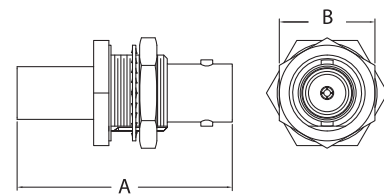


FIGURE 6

## RECEPTACLES

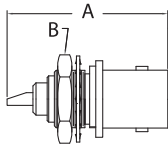


FIGURE 7

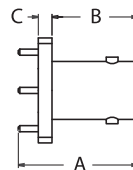


FIGURE 8

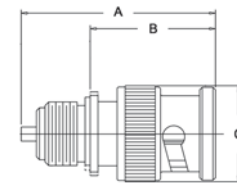


FIGURE 9

Item Number	Military PN	Product Description	Gender	Finish	Dimensions				Cable Group	Cable Procedure	Crimp Die	Mounting Hole	Figure #
					A	B	C	D					
2029-9-9		Adapter, Bulkhd, Jk-Jk	F-F	Nickel	1.280	0.690					X	1	
2029-17-9 QD		Adapter, Bulkhd, Jk-Jk, Iso Gd, Hex	F-F	Nickel	1.280	0.630					X	1	
2029-33-9		Adapter, Bulkhd, Jk-Jk, Iso Gd, Spanner	F-F	Nickel	1.280	0.630					X	1	
2029-15-9		Adapter, Jk-Jk	F-F	Nickel	1.280							2	
2029-20-9		Adapter, Rt Angle, Jk-Plg	F-M	Nickel	1.030	0.900						3	
2029-16-9		Adapter, Tee, Jk-Plg-Jk	F-M-F	Nickel	1.280	1.060						4	
2555-3-32		Termination, 0.1%, 1/2 Watt	M	Nickel	1.000	0.570						5	
2022-29-9		Jack, Bulkhd, Rear Mt	F	Nickel	1.400	0.630			25	CP-465	KTH-2010	X	6
2022-32-9		Jack, Bulkhd, Rear Mt	F	Nickel	1.220	0.500			26	3-661-1	KTH-2185	AB	6
2022-17-29		Jack, Bulkhd, Rear Mt	F	Nickel	1.610	0.690			30	3-661-5	KTH-2186	X	6
2022-18-29		Jack, Bulkhd, Rear Mt	F	Nickel	1.610	0.630			31	3-661-5	KTH-2185	X	6
2022-28-9		Jack, Bulkhd, Rear Mt	F	Nickel	1.400	0.241			Q	CP-465	KTH-2010	X	6
2024-7-9		Receptacle, Bulkhd, Jack	F	Nickel	1.060	0.500				SOLDER		H	7
2027-17-29		Receptacle, PCB	F	Nickel	0.780	0.560	0.090			SOLDER			8
2024-16-9		Receptacle, Bulkhd, Plug	M	Nickel	1.130	0.723	0.573			SOLDER		AB	9

ANGLE PLUGS

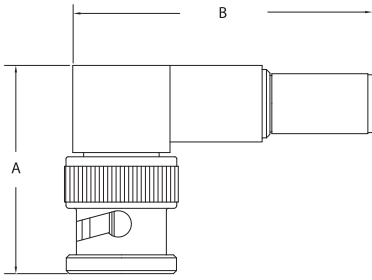


FIGURE 10

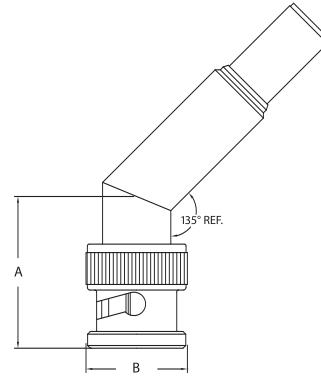


FIGURE 11

PLUGS

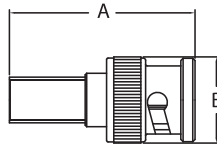


FIGURE 12

Item Number	Military PN	Product Description	Gender	Finish	Dimensions				Cable Group	Cable Procedure	Crimp Die	Mounting Hole	Figure #
					A	B	C	D					
2026-16-9		Plug, Crimp, Rt Angle	M	Nickel	1.030	1.330			30	3-661-5	KTH-2186		10
2026-17-9		Plug, Crimp, Rt Angle	M	Nickel	1.030	1.330			31	3-661-5	KTH-2185		10
2026-33-9		Plug, Crimp, Rt Angle	M	Nickel	1.030	1.480			25	3-661-5	KTH-2255		10
2026-34-9		Plug, Crimp, Rt Angle	M	Nickel	1.030	1.480			Q	3-661-5	KTH-2119		10
2026-35-9		Plug, Crimp, 45 Deg Angle	M	Nickel	0.840	0.570			30	3-661-5	KTH-2186		11
2026-35-9 M66		Plug, Crimp, 45 Deg Angle, Bulk Pkg	M	Nickel	0.840	0.570			30	3-661-5	KTH-2186		11
2026-36-9		Plug, Crimp, 45 Deg Angle	M	Nickel	0.840	0.570			31	3-661-5	KTH-2185		11
2026-36-9 M66		Plug, Crimp, 45 Deg Angle, Bulk Pkg	M	Nickel	0.840	0.570			31	3-661-5	KTH-2185		11
2025-44-9		Plug, Crimp	M	Nickel	1.200	0.570			31	3-661-5	KTH-2185		12
2025-44-9 M66		Plug, Crimp, Bulk Pkg	M	Nickel	1.200	0.570			31	3-682	KTH-2185		12
2025-76-9		Plug, Crimp	M	Nickel	1.200	0.570			30	3-661-5	KTH-2186		12
2065-1-9		Plug, Crimp	M	Nickel	1.220	0.570			27	3-661-1	KTH-2261		12
2065-1-9 M66		Plug, Crimp, Bulk Pkg	M	Nickel	1.220	0.570			27	3-661-1	KTH-2261		12
2065-2-9		Plug, Crimp	M	Nickel	1.220	0.570			24	3-661-1	KTH-2261		12
2065-2-9 M66		Plug, Crimp, Bulk Pkg	M	Nickel	1.220	0.570			24	3-661-1	KTH-2261		12
2065-7-9		Plug, Crimp	M	Nickel	1.220	0.570			G1	3-661-1	KTH-2261		12
2065-7-9 M66		Plug, Crimp, Bulk Pkg	M	Nickel	1.220	0.570			G1	3-661-1	KTH-2261		12
2065-8-9		Plug, Crimp	M	Nickel	1.220	0.570			81	3-661-3	KTH-2004		12
2065-8-9 M66		Plug, Crimp, Bulk Pkg	M	Nickel	1.220	0.570			81	3-661-3	KTH-2004		12
2065-10-9		Plug, Crimp	M	Nickel	1.220	0.570			25	3-661-4	KTH-2255		12
2065-10-9 M66		Plug, Crimp, Bulk Pkg	M	Nickel	1.220	0.570			25	3-661-4	KTH-2255		12
2065-11-9		Plug, Crimp	M	Nickel	1.220	0.570			26	3-661-1	KTH-2025		12
2065-11-9 M66		Plug, Crimp, Bulk Pkg	M	Nickel	1.220	0.570			26	3-661-1	KTH-2025		12
2065-15-9		Plug, Crimp	M	Nickel	1.220	0.570			Q	3-661-4	KTH-2119		12
2065-15-9 M66		Plug, Crimp, Bulk Pkg	M	Nickel	1.220	0.570			Q	3-661-4	KTH-2119		12
2065-28-9		Plug, Crimp	M	Nickel	1.210	0.560			23B	3-661-1	KTH-2258		12
2065-29-9		Plug, Crimp	M	Nickel	1.210	0.560			23A	3-764-1	KTH-2276		12

# LONG BARREL BNC



- 75 Ohm performance suitable for Analog, Serial Digital and HDTV applications.
- Meets or exceeds SMPTE 424M (3G-SDI) requirements.
- Several configurations available to fit a variety of cables.
- Simple, full crimp design for easy field installation.
- Quick connect and disconnect with Bayonet coupling.
- Ergonomic Design - longer grip

## SPECIFICATIONS

### MATERIAL

Body: Brass  
 Outer Contact: Beryllium Copper  
 Insulator: PTFE  
 K-Grip Sleeve: Commercial Bronze

### FINISHES

Body: Nickel  
 Contacts: Gold

### ELECTRICAL

Impedance: 75 Ohms  
 Voltage Rating: 500 Volts RMS  
 Return Loss: 1.5 GHz, < -31 dB min  
 3 GHz, < -24 dB min  
 6 GHz, < -20 dB min  
 Contact Resistance: Center 0.0014 Ohms  
 Outer 0.002 Ohms  
 Insulation Resistance: 5000 megohms

### MECHANICAL

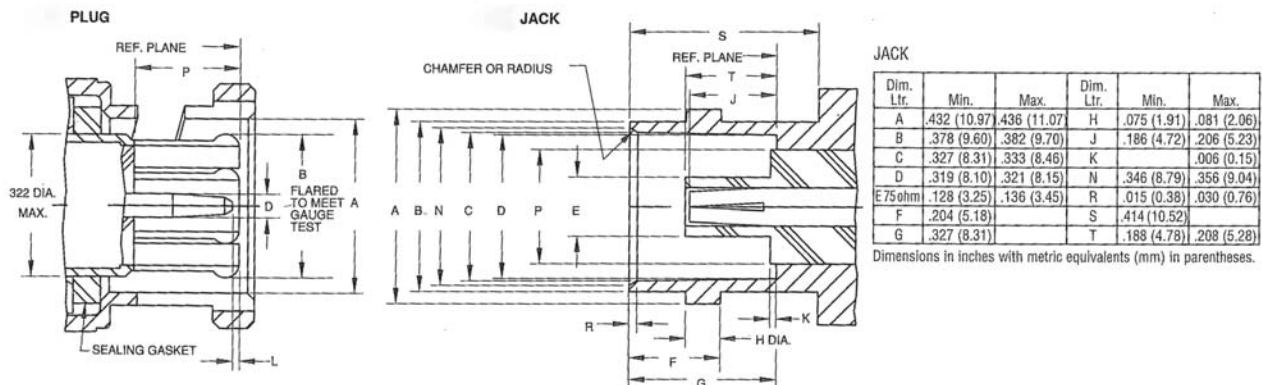
Life: 500 cycles minimum  
 Cable Retention: 10 lbs to 40 lbs, Depending on Cable Size

Engagement Force: 2.5 lbs maximum, Torque  
 3.0 lbs maximum, Longitudinal

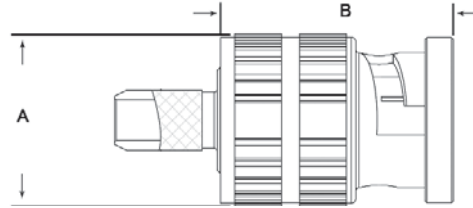
### ENVIRONMENTAL

Temperature: -65°C to +165°C  
 Moisture: 0 to 95%  
 MIL-STD-202 Method 106  
 Corrosion: MIL-STD-202 Method 101, Test Condition B  
 Flammability: UL 94-VO Rated  
 Vibration: MIL-STD-202 Method 204, Test Condition B  
 Solvent Resistance: MIL-STD-202 Method 215

## INTERFACE DIMENSIONS



**PLUGS**



**FIGURE 1**

Item Number	Military PN	Product Description	Gender	Finish	Dimensions		Contact Hex	Ferrule Hex	Cable Group	Cable Procedure	Crimp Die	Mounting Hole	Figure #
					A	B							
2065-E00-C7202N		Plug, 75 Ohm	M	Nickel	0.572	0.771	0.041	0.178	26	3-661-1	KTH-5003		1
2065-E00-C7102N		Plug, 75 Ohm	M	Nickel	0.572	0.771	0.041	0.255	24	3-661-1	KTH-5003		1
2065-E00-C9004N		Plug, 75 Ohm	M	Nickel	0.572	0.771	0.046	0.278	25	3-661-1	KTH-5003		1

## PATCH PLUGS



- 75 Ohm Impedance, HDTV capable.
- Made to fit a variety of industry leading cables.
- Simple crimp style design allows for quick and easy field installation.
- Standard Size patch plugs mate with Standard Size video jacks (.090( Pin Size)
- Mid-Size patch plugs mate with Mid-Size video jacks (.050( Pin Size)

## SPECIFICATIONS

### MATERIAL

Body:	Brass
Contacts:	Brass
Insulators:	PTFE
Crimp Sleeves:	Commercial Bronze

### FINISHES

Body:	Nickel
Contacts:	Gold

### ELECTRICAL

Impedance:	75 Ohms
Frequency Range:	DC to 2.5 GHz
Voltage Rating:	500 VRMS

### PATCH PLUG TERMINATION

- 75 Ohm Impedance, operates to 2.5 GHz.
- Durable construction.
- Eliminates open circuits by matching impedance of the connected line.
- Prevents signal reflection and possible associated equipment malfunction.

### MECHANICAL

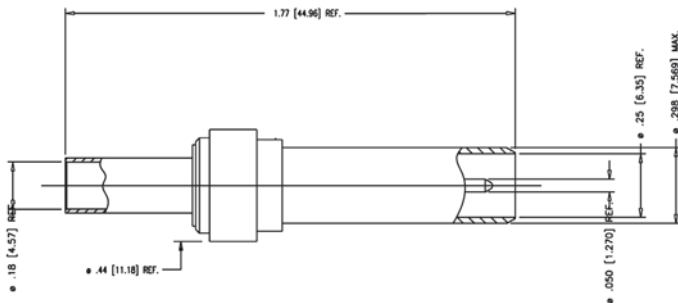
Life:	500 cycles minimum
-------	--------------------

### ENVIRONMENTAL

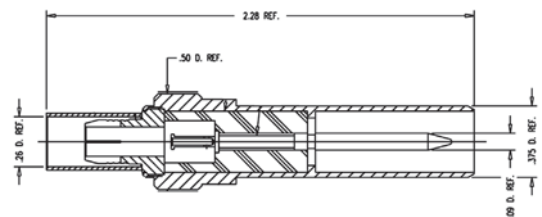
Moisture:	MIL-STD-202 Method 106
Corrosion:	MIL-STD-202 Method 101

## INTERFACE DIMENSIONS

Mid-Size



Standard



**PLUGS**

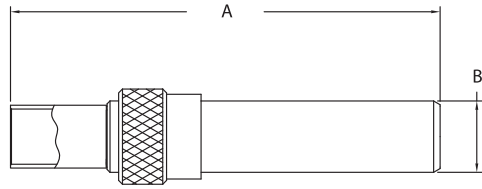


FIGURE 1

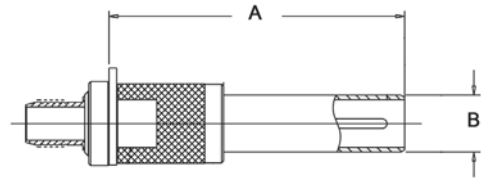


FIGURE 2

**TERMINATION**

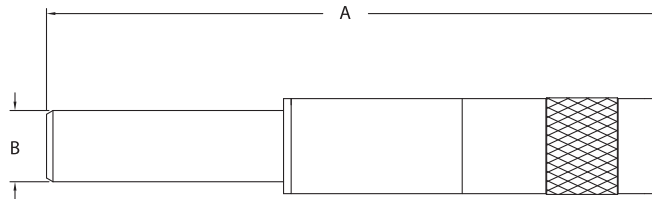
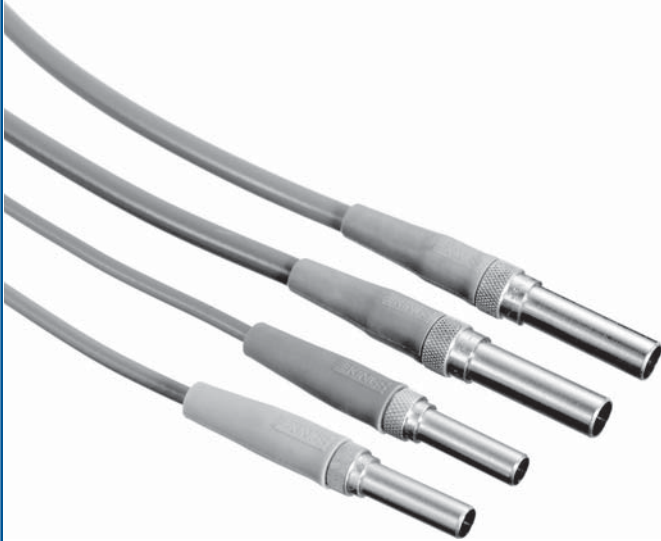


FIGURE 3

Item Number	Military PN	Product Description	Gender	Finish	Dimensions				Cable Group	Cable Procedure	Crimp Die	Mounting Hole	Figure #
					A	B	C	D					
7410-10 QD		Patch Plug, Mid-Size	M	Nickel	1.770	0.298			26	CP-401	KTH-2025		1
7410-16		Patch Plug, Mid-Size	M	Nickel	1.790	0.298			25	CP-401	KTH-2255		1
7410-20		Patch Plug, Mid-Size	M	Nickel	1.790	0.298			24	CP-401	KTH-2261		1
7510-1		Patch Plug, Standard Size	M	Nickel	2.280	0.375			G1	CP-470	KTH-2002		1
7510-16 QD		Patch Plug, Standard Size	M	Nickel	2.280	0.375			25	CP-470	KTH-2267		1
7510-21		Patch Plug, Standard Size	M	Nickel	2.280	0.375			24	CP-470	KTH-2261		1
7510-4		Patch Plug, Standard Size	M	Nickel	2.280	0.375			Q	CP-470	KTH-2012		1
7410-14		Patch Plug, Mid-Size	M	Nickel	1.550	0.300			30	3-661-5	KTH-2286		2
7410-15		Patch Plug, Mid-Size	M	Nickel	1.610	0.300			31	3-680	KTH-2185		2
7510-7		Patch Termination, 75 Ohm	M	Nickel	3.250	0.375							3



**	COLOR
-01	BROWN
-02	RED
-03	ORANGE
-04	YELLOW
-05	GREEN
-06	BLUE
-07	VIOLET
-08	GREY
-09	WHITE
-10	BLACK

- Pre-assembled for quick and easy installation.
- Available in 10 popular colors for visual signal identification or other personalization.
- Matching protective boots also included.

#### STANDARD SIZE:

- Each assembly contains two KINGS® Standard Size 75 Ohm patch plugs (7510-16).
- Terminated to Belden 1694A or equivalent cable in a variety of lengths.

#### MID-SIZE:

- Each assembly contains two KINGS® Mid-Size 75 Ohm patch plugs (7410-10).
- Terminated to Belden 1855A or equivalent cable in a variety of lengths.

CORDS

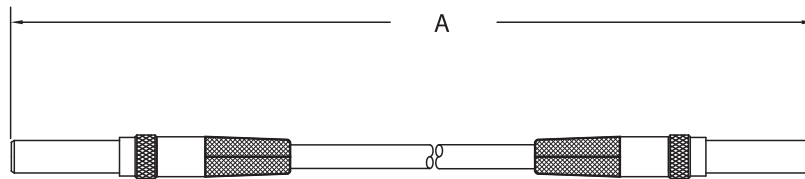
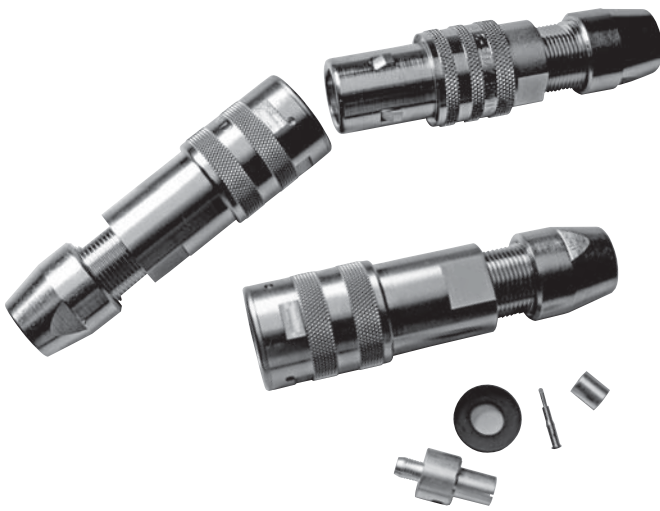


FIGURE 1

Item Number	Military PN	Product Description	Gender	Finish	Dimensions				Cable Group	Cable Procedure	Crimp Die	Mounting Hole	Figure #
					A	B	C	D					
K-8845-012-**		Standard Size, Belden 1694A, 12"	PATCH(M-M)		12.000								1
K-8845-120-**		Standard Size, Belden 1694A, 120"	PATCH(M-M)		120.000								1
K-8845-018-**		Standard Size, Belden 1694A, 18"	PATCH(M-M)		18.000								1
K-8845-024-**		Standard Size, Belden 1694A, 24"	PATCH(M-M)		24.000								1
K-8845-036-**		Standard Size, Belden 1694A, 36"	PATCH(M-M)		36.000								1
K-8845-048-**		Standard Size, Belden 1694A, 48"	PATCH(M-M)		48.000								1
K-8845-060-**		Standard Size, Belden 1694A, 60"	PATCH(M-M)		60.000								1
K-8845-072-**		Standard Size, Belden 1694A, 72"	PATCH(M-M)		72.000								1
K-8845-084-**		Standard Size, Belden 1694A, 84"	PATCH(M-M)		84.000								1
K-8845-096-**		Standard Size, Belden 1694A, 96"	PATCH(M-M)		96.000								1
K-8846-012-**		Mid-Size, Belden 1855A, 12"	PATCH(M-M)		12.000								1
K-8846-120-**		Mid-Size, Belden 1855A, 120"	PATCH(M-M)		120.000								1
K-8846-144-**		Mid-Size, Belden 1855A, 144"	PATCH(M-M)		144.000								1
K-8846-024-**		Mid-Size, Belden 1855A, 24"	PATCH(M-M)		24.000								1
K-8846-288-**		Mid-Size, Belden 1855A, 288"	PATCH(M-M)		288.000								1
K-8846-036-**		Mid-Size, Belden 1855A, 36"	PATCH(M-M)		36.000								1
K-8846-048-**		Mid-Size, Belden 1855A, 48"	PATCH(M-M)		48.000								1
K-8846-060-**		Mid-Size, Belden 1855A, 60"	PATCH(M-M)		60.000								1
K-8846-072-**		Mid-Size, Belden 1855A, 72"	PATCH(M-M)		72.000								1
K-8846-096-**		Mid-Size, Belden 1855A, 96"	PATCH(M-M)		96.000								1





**SPECIFICATIONS**

**MATERIAL**

Body:	Brass
Center Contacts:	Brass (Male) Beryllium Copper (Female)
Insulators:	PTFE
Spring Member:	Beryllium Copper

**FINISHES**

Body:	Nickel
Center Contacts:	Gold over Nickel
Outer Contacts:	Silver

**ELECTRICAL**

Impedance:	75 Ohms
Return Loss:	Up to 500 MHz, -20 dB minimum Up to 750 MHz, -17 dB minimum
Operating Freq:	DC to 2.5 GHz

**MECHANICAL**

Life:	30,000 cycles minimum
Cable Retention:	140 lbs minimum, 1/2" diameter cable 100 lbs minimum, 3/8" diameter cable

**ENVIRONMENTAL**

Moisture:	0 to 98% MIL-STD-202 Method 106
Temperature:	-20° to +70° C
Corrosion:	MIL-STD-202 Method 101

- Durable weatherproof construction— Ideal for outdoor use.
- Performs in even the harshest environments.
- Easy, two-crimp installation of plugs and jacks.
- Push-on, pull-apart mating.
- Non-conductive anti-shock safety tip on contacts.
- 75 Ohm Impedance.
- Adapters are available in a variety of configurations.
- Inspection gauges allow for quick and easy verification of interface dimensions and proper mating.
- Inexpensive retrofit kits for field replacement of damaged or non-functioning internal Tri-Loc® parts.

**STANDARD PLUG**

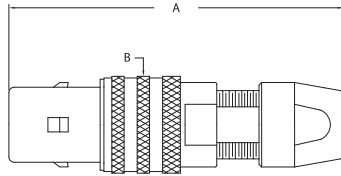


FIGURE 1

**ANGLE PLUG**

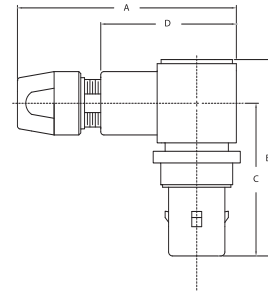


FIGURE 2

**BULKHEAD PLUG - FRONT MOUNT**

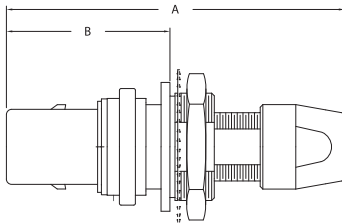


FIGURE 3

**STANDARD JACK**

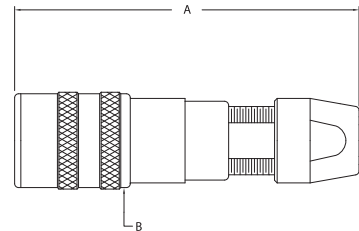
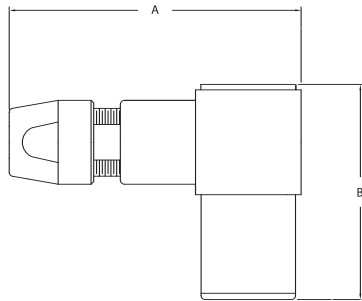


FIGURE 4

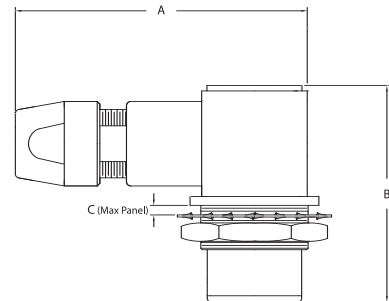
Item Number	Military PN	Product Description	Gender	Finish	A	Dimensions B	C	D	Cable Group	Cable Procedure	Crimp Die	Mounting Hole	Figure #
7705-1		Plug	M	Nickel	3.880	1.140			70	KAI-8010	KTH-2040		1
7705-2		Plug	M	Nickel	3.880	1.140			73	KAI-8010	KTH-2002		1
7705-3		Plug	M	Nickel	3.880	1.140			74	KAI-8010	KTH-2041		1
7705-9		Plug	M	Nickel	3.880	1.140			76	KAI-8010	KTH-2002		1
7705-4		Plug	M	Nickel	3.880	1.140			78	KAI-8010	KTH-2002		1
7705-6		Plug	M	Nickel	3.880	1.140			79	KAI-8010	KTH-2040		1
7705-5		Plug	M	Nickel	3.880	1.140			80	KAI-8010	KTH-2012		1
7706-1		Plug, Angle	M	Nickel	3.440	3.100	2.410	2.140	73	3-499			2
7706-2		Plug, Angle	M	Nickel	3.440	3.100	2.410	2.140	74	3-499			2
7702-1		Plug, Bulkhd, Front Mt	M	Nickel	3.880	1.950			70	KAI-8010	KTH-2040	AH	3
7702-2		Plug, Bulkhd, Front Mt	M	Nickel	3.880	1.950			73	KAI-8010	KTH-2002	AH	3
7702-3		Plug, Bulkhd, Front Mt	M	Nickel	3.880	1.950			74	KAI-8010	KTH-2041	AH	3
KP-8012-767-400		Plug, Bulkhd, Front Mt	M	Nickel	3.880	1.950			76	KAI-8010	KTH-2002	AH	3
7702-14		Plug, Bulkhd, Front Mt	M	Nickel	3.880	1.950			79	KAI-8011	KTH-2040	AH	3
7703-1		Jack	F	Nickel	4.000	1.120			70	KAI-8010	KTH-2040		4
7703-2		Jack	F	Nickel	4.000	1.120			73	KAI-8010	KTH-2002		4
7703-3		Jack	F	Nickel	4.000	1.120			74	KAI-8010	KTH-2041		4
7703-9		Jack	F	Nickel	4.000	1.120			76	KAI-8010	KTH-2002		4
7703-6		Jack	F	Nickel	4.000	1.120			78	KAI-8010	KTH-2002		4
7703-8		Jack	F	Nickel	4.000	1.120			79	KAI-8010	KTH-2040		4
7703-7		Jack	F	Nickel	4.000	1.120			80	KAI-8010	KTH-2012		4

**ANGLE JACK**



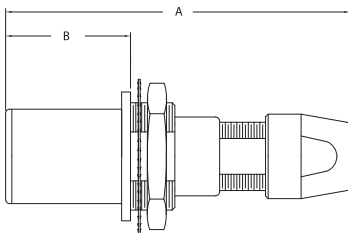
**FIGURE 5**

**ANGLE BULKHEAD JACK  
REAR MOUNT**



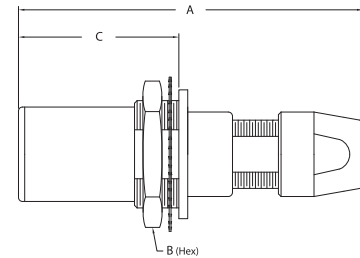
**FIGURE 6**

**BULKHEAD JACK - FRONT MOUNT**



**FIGURE 7**

**BULKHEAD JACK - REAR MOUNT**



**FIGURE 8**

Item Number	Military PN	Product Description	Gender	Finish	Dimensions				Cable Group	Cable Procedure	Crimp Die	Mounting Hole	Figure #
					A	B	C	D					
7703-4		Jack, Angle	F	Nickel	3.440	2.490			73	3-499			5
7703-5		Jack, Angle	F	Nickel	3.440	2.490			74	3-499			5
7702-10		Jack, Angle, Bulkhd, Rear Mt	F	Nickel	3.440	2.490	0.250		70	3-499		AG	6
7702-11		Jack, Angle, Bulkhd, Rear Mt	F	Nickel	3.440	2.490	0.250		73	3-499		AG	6
7702-12		Jack, Angle, Bulkhd, Rear Mt	F	Nickel	3.440	2.490	0.250		74	3-499		AG	6
7702-4		Jack, Bulkhd, Front Mt	F	Nickel	4.000	1.480			70	KAI-8010	KTH-2040	AH	7
7702-5		Jack, Bulkhd, Front Mt	F	Nickel	4.000	1.480			73	KAI-8010	KTH-2002	AH	7
7702-6		Jack, Bulkhd, Front Mt	F	Nickel	4.000	1.480			74	KAI-8010	KTH-2041	AH	7
7702-13		Jack, Bulkhd, Front Mt	F	Nickel	4.000	1.480			76	KAI-8010	KTH-2002	AH	7
7702-17		Jack, Bulkhd, Front Mt	F	Nickel	4.000	1.480			78	KAI-8010	KTH-2002	AH	7
7702-15		Jack, Bulkhd, Front Mt	F	Nickel	4.000	1.480			79	KAI-8011	KTH-2040	AH	7
7702-7		Jack, Bulkhd, Rear Mt	F	Nickel	4.000	1.500	1.830		70	KAI-8010	KTH-2040	AH	8
7702-8		Jack, Bulkhd, Rear Mt	F	Nickel	4.000	1.500	1.830		73	KAI-8010	KTH-2002	AH	8
7702-9		Jack, Bulkhd, Rear Mt	F	Nickel	4.000	1.500	1.830		74	KAI-8010	KTH-2041	AH	8
KP-8021-767-400		Jack, Bulkhd, Rear Mt	F	Nickel	4.000	1.500	1.830		76	KAI-8010	KTH-2002	AH	8

ADAPTERS

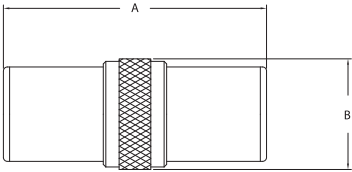


FIGURE 9

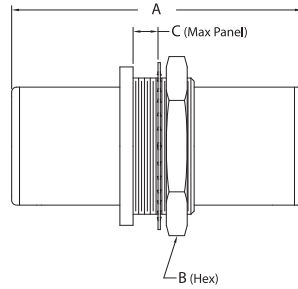


FIGURE 10

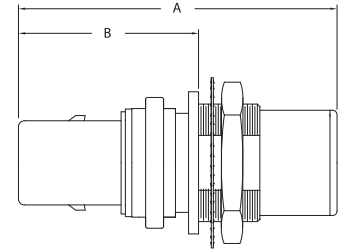


FIGURE 11

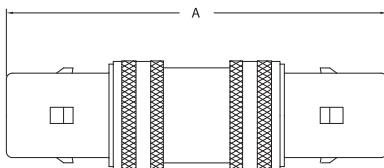


FIGURE 12

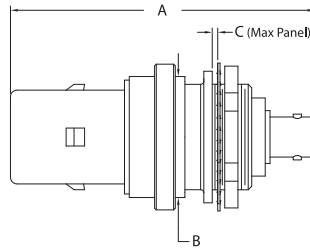


FIGURE 13

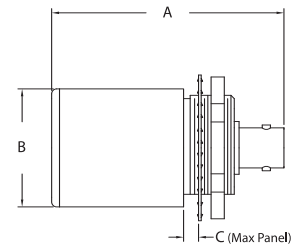


FIGURE 14

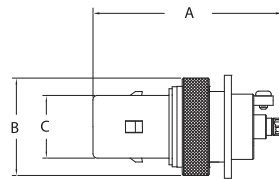
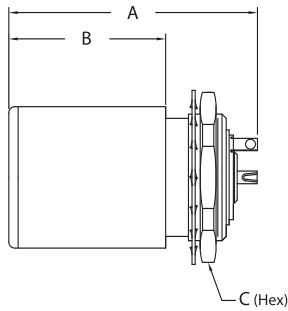


FIGURE 15

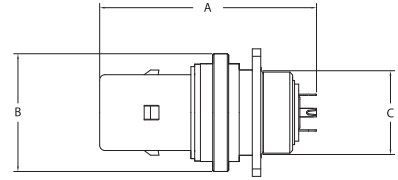
Item Number	Military PN	Product Description	Gender	Finish	A	B	Dimensions C	D	Cable Group	Cable Procedure	Crimp Die	Mounting Hole	Figure #
7709-1		Adapter, Jack-Jack	F-F	Nickel	2.750	1.260							9
7709-2		Adapter, Jack-Jack, Blkhd	F-F	Nickel	2.750	1.500	0.250					AG	10
7709-3		Adapter, Jack-Jack, Blkhd	F-F	Nickel	2.750	1.500	0.250					AH	10
7709-5		Adapter, Jack-Plug, Blkhd	F-M	Nickel	3.350	1.950						AH	11
7709-6		Adapter, Plug-Plug	M-M	Nickel	4.000								12
KP-8001-001-012		Adapter, Bulkhd, Tri-Loc® to BNC	TLOC(M)-BNC(F)	Nickel	2.880	1.120	0.233					AD	13
KP-8001-002-012		Adapter, Bulkhd, Tri-Loc® to BNC	TLOC(M)-BNC(F)	Nickel	2.880	1.120	0.233					AE	13
KP-8002-002-012		Adapter, Bulkhd, Tri-Loc® to BNC	TLOC(F)-BNC(F)	Nickel	2.150	1.120	0.318					AE	14
7709-8		Adapter, Panel, Tri-Loc® to SMB	TLOC(M)-SMB (F)	Nickel	2.690	1.380	0.890					AJ	15

**BULKHEAD RECEPTACLE  
FRONT MOUNT**



**FIGURE 16**

**PANEL RECEPTACLE  
FRONT MOUNT**



**FIGURE 17**

**RETRO-FIT KITS, INSPECTION GAUGES**

Item Number	Military PN	Product Description	Gender	Finish	Dimensions				Cable Group	Cable Procedure	Crimp Die	Mounting Hole	Figure #
					A	B	C	D					
7704-1		Receptacle, Bulkhd, Front Mt	F	Nickel	1.970	1.250	1.250			SOLDER		AD	16
7704-2		Receptacle, Bulkhd, Front Mt	F	Nickel	1.970	1.250	1.250			SOLDER		AE	16
7704-3		Receptacle, Bulkhd, Front Mt	F	Nickel	1.970	1.250	1.250			SOLDER		AF	16
7704-4		Receptacle, Bulkhd, Front Mt	F	Nickel	1.970	1.250	1.250			SOLDER		AC	16
7704-5		Receptacle, Bulkhd, Front Mt	M	Nickel	2.570	1.500	1.250			SOLDER		AD	16
7704-6		Receptacle, Bulkhd, Front Mt	M	Nickel	2.570	1.500	1.250			SOLDER		AE	16
7704-7		Receptacle, Bulkhd, Front Mt	M	Nickel	2.570	1.500	1.250			SOLDER		AF	16
7704-8		Receptacle, Bulkhd, Front Mt	M	Nickel	2.570	1.500	1.250			SOLDER		AC	16
7704-9		Receptacle, Bulkhd, Front Mt	F	Nickel	2.570	1.378	1.000			SOLDER		AI	16
7707-1		Receptacle, Panel	F	Nickel	2.570	1.380	0.980			SOLDER		AK	17
7708-4		Retrofit Kit, Standard Female, CG 70	F						70		KTH-2040		
7708-5		Retrofit Kit, Standard Female, CG 73/76/78	F						73/76/78		KTH-2002		
7708-6		Retrofit Kit, Standard Female, CG 74	F						74		KTH-2041		
7708-7		Retrofit Kit, Standard Female, CG 79	F						79		KTH-2040		
7708-12		Retrofit Kit, Standard Female, CG 80	F						80		KTH-2012		
7708-1		Retrofit Kit, Standard Male, CG 70	M						70		KTH-2040		
7708-8		Retrofit Kit, Standard Male, CG 79	M						79		KTH-2040		
7708-2		Retrofit Kit, Standard Male, CG 73/76/78	M						73/76/78		KTH-2002		
7708-3		Retrofit Kit, Standard Male, CG 74	M						74		KTH-2041		
7708-11		Retrofit Kit, Standard Male, CG 80	M						80		KTH-2012		
KP-8000-063		Gauge, Inner Body to Center Conductor (F)	F										
KP-8000-061		Gauge, Inner Body to Center Conductor (M)	M										
KP-8000-062		Gauge, Inner Body to Outer Body (F)	F										
KP-8000-060		Gauge, Inner Body to Outer Body (M)	M										



## SPECIFICATIONS

### MATERIAL

Body:	Brass
Entry Body:	Beryllium Copper
Insulators:	PTFE
Spring Member:	Beryllium Copper
Crimp Sleeves:	Commercial Bronze

### FINISHES

Body:	Nickel
Center Contacts:	Gold

### ELECTRICAL

Impedance:	75 Ohms
Return Loss:	Up to 500 MHz, -20 dB minimum Up to 750 MHz, -17 dB minimum
Operating Freq:	DC to 2.5 GHz

### MECHANICAL

Life:	30,000 cycles minimum
Cable Retention:	140 lbs minimum, 1/2" diameter cable 100 lbs minimum, 3/8" diameter cable

### ENVIRONMENTAL

Moisture:	0 to 98% MIL-STD-202 Method 106
Temperature:	-20° to +70° C
Corrosion:	MIL-STD-202 Method 101

- 75 Ohm performance is suitable for Analog, Serial Digital, and HDTV.
- Rugged weatherproof design—Ideal for outdoor use.
- Meets or exceeds SMPTE 292 requirements.
- Mates with Fischer 1051 Series triaxial connectors.
- Push-on coupling with audible “snap” to ensure proper mating.
- Plugs and jacks available for 8mm, 11mm, and 14mm cables.
- Retro Fit kits available for field replacement without re-termination of entire connector.

STANDARD JACK

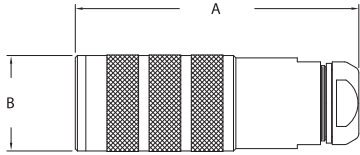


FIGURE 1

BULKHEAD JACK - FRONT MOUNT

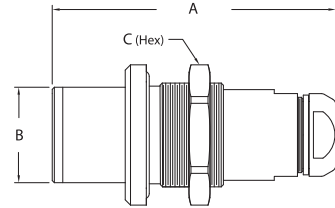


FIGURE 2

BULKHEAD RECEPTACLE - FRONT MOUNT

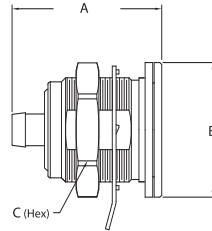


FIGURE 3

Item Number	Military PN	Product Description	Gender	Finish	Dimensions				Cable Group	Cable Procedure	Crimp Die	Mounting Hole	Figure #
					A	B	C	D					
780370		Jack, Crimp	F	Nickel	2.690	0.905			70	3-651	KTH-2040 KTH-2043		1
780373		Jack, Crimp	F	Nickel	2.690	0.905			73	3-651	KTH-8001		1
780374		Jack, Crimp	F	Nickel	2.690	0.905			74	3-651	KTH-8002		1
780376		Jack, Crimp	F	Nickel	2.690	0.905			76	3-651	KTH-8001		1
780380		Jack, Crimp	F	Nickel	2.690	0.905			80	3-651	KTH-2004 KTH-2012		1
780390		Jack, Crimp	F	Nickel	2.690	0.905			90	3-651	KTH-2267 KTH-2260		1
780270		Jack, Crimp, Bulkhd	F	Nickel	2.690	0.905	1.187		70	3-651	KTH-2040 KTH-2043	AL	2
780273		Jack, Crimp, Bulkhd	F	Nickel	2.690	0.905	1.187		73	3-651	KTH-8001	AL	2
780274		Jack, Crimp, Bulkhd	F	Nickel	2.690	0.905	1.187		74	3-651	KTH-8002	AL	2
780276		Jack, Crimp, Bulkhd	F	Nickel	2.690	0.905	1.187		76	3-651	KTH-8001	AL	2
780280		Jack, Crimp, Bulkhd	F	Nickel	2.690	0.905	1.187		80	3-651	KTH-2004 KTH-2012	AL	2
780290		Jack, Crimp, Bulkhd	F	Nickel	2.690	0.905	1.187		90	3-651	KTH-2267 KTH-2260	AL	2
781273		Receptacle, Plug, Bulkhd	M	Nickel	1.580	1.416	1.250		73	3-794		AM	3

**STANDARD PLUG**

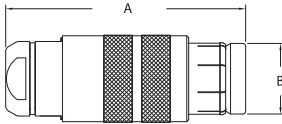


FIGURE 4

**BULKHEAD PLUG - FRONT MOUNT**

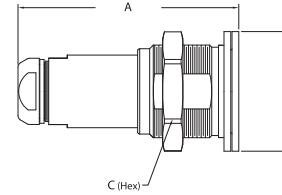


FIGURE 5

**RETRO-FIT KITS**

Item Number	Military PN	Product Description	Gender	Finish	Dimensions				Cable Group	Cable Procedure	Crimp Die	Mounting Hole	Figure #
					A	B	C	D					
780670		Plug, Crimp	M	Nickel	2.529	0.744			70	3-651	KTH-2040 KTH-2043		4
780673		Plug, Crimp	M	Nickel	2.529	0.744			73	3-651	KTH-8001		4
780674		Plug, Crimp	M	Nickel	2.529	0.744			74	3-651	KTH-8002		4
780676		Plug, Crimp	M	Nickel	2.529	0.744			76	3-651	KTH-8001		4
780680		Plug, Crimp	M	Nickel	2.529	0.744			80	3-651	KTH-2004 KTH-2012		4
780690		Plug, Crimp	M	Nickel	2.529	0.744			90	3-651	KTH-2267 KTH-2260		4
780570		Plug, Crimp, Bulkhd	M	Nickel	2.614	1.416	1.250		70	3-651	KTH-2040 KTH-2043	AM	5
780573		Plug, Crimp, Bulkhd	M	Nickel	2.614	1.416	1.250		73	3-651	KTH-8001	AM	5
780574		Plug, Crimp, Bulkhd	M	Nickel	2.614	1.416	1.250		74	3-651	KTH-8002	AM	5
780576		Plug, Crimp, Bulkhd	M	Nickel	2.614	1.416	1.250		76	3-651	KTH-8001	AM	5
780580		Plug, Crimp, Bulkhd	M	Nickel	2.614	1.416	1.250		80	3-651	KTH-2004 KTH-2012	AM	5
780590		Plug, Crimp, Bulkhd	M	Nickel	2.614	1.416	1.250		90	3-651	KTH-2267 KTH-2260	AM	5
783870		Retrofit Kit, Female, CG 70	F						70				
783873		Retrofit Kit, Female, CG 73	F						73				
783874		Retrofit Kit, Female, CG 74	F						74				
783876		Retrofit Kit, Female, CG 76	F						76				
783880		Retrofit Kit, Female, CG 80	F						80				
783890		Retrofit Kit, Female, CG 90	F						90				
785870		Retrofit Kit, Male, CG 70	M						70				
785873		Retrofit Kit, Male, CG 73	M						73				
785874		Retrofit Kit, Male, CG 74	M						74				
785876		Retrofit Kit, Male, CG 76	M						76				
785880		Retrofit Kit, Male, CG 80	M						80				
785890		Retrofit Kit, Male, CG 90	M						90				





- Quick connect Push/Pull system.
- Locking mechanism that will not vibrate loose as threaded connectors are prone to do.
- When mated, the connectors can rotate 360°.
- Allows for connectors to be 2-3 times more densely packed than BNC's.
- Operation up to 10 GHz.
- Supports 3Gbps HD SDI applications.
- Uses existing tooling.
- Crimp center contact.

**SPECIFICATIONS**

**MATERIAL**

Body:	Brass
Center Contacts:	Beryllium Copper
Insulators:	PTFE
Ferrule:	Bronze

**FINISHES**

Body:	Nickel over Copper
Outer & Center Contacts:	Gold over Nickel
Ferrule:	Nickel over Copper

**ELECTRICAL**

Impedance:	75 Ohms
Return Loss:	1 GHz < -32 dB 3 GHz < -23 dB 6 GHz < -15 dB
Frequency Range:	DC to 10 GHz

**MECHANICAL**

Life:	500 cycles minimum
Mating:	Push/Pull, Slide-on

**PLUGS**

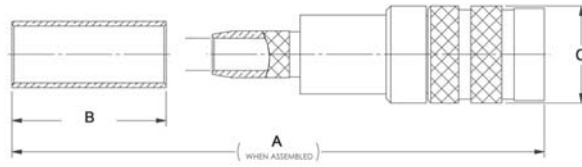


FIGURE 1

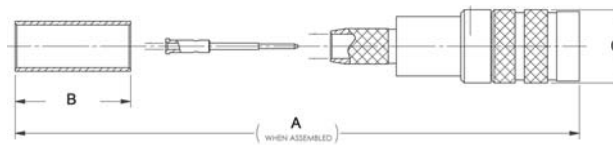


FIGURE 2

**PCB JACK**

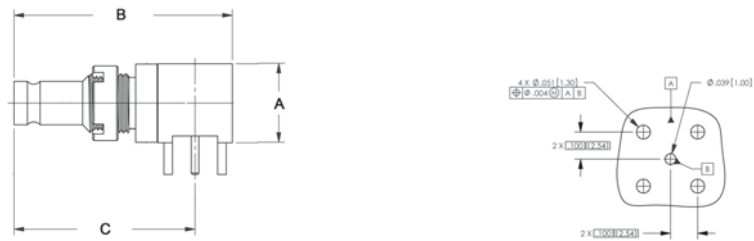


FIGURE 3

Item Number	Military PN	Product Description	Gender	Finish	Dimensions				Cable Group	Cable Procedure	Crimp Die	Mounting Hole	Figure #
					A	B	C	D					
0345-E00-C7201N		Plug, 75 Ohm, Captured C/C	M	Nickel	1.287	0.500	0.315		26	CAP-E02	KTH-2025		1
0345-E00-C7202N		Plug, 75 Ohm	M	Nickel	1.287	0.500	0.315		26	CAP-E03	KTH-2025		2
034B-060-00401H		Jack, 75 Ohm, Right Angle, PCB	F	Gold	0.292	0.808	0.670						3



- 75 Ohm Nominal Impedance.
- Micro-miniature size permits higher circuit density - Up to 56 circuits per 19" panel.
- Positive locking equipment connections prevent accidental unmating.
- Crimp contacts allow for in-house installation.
- Patch and equipment plugs designed to terminate to popular industry cables, such as Belden 1855A and GepCo VDM 230.
- Frequency Range: Up to 2.4 GHz

## SPECIFICATIONS

### AUDIO-VIDEO JACKS:

#### MATERIAL

Plug Insulators:	PTFE
Top & Bottom Insulators:	Polymethylpentene
Termination Contacts:	Beryllium Copper
Female Contacts:	Beryllium Copper
Male Contacts:	Brass
All Other Metal Parts:	Zinc

#### FINISHES

Contacts:	Gold
All Other Parts:	Nickel

#### ELECTRICAL

Impedance:	75 Ohms
Frequency Range:	DC to 2.4 GHz
Voltage Rating:	500 Volts RMS
Termination Resistance:	75 Ohms, 2%
Return Loss:	-20 dB Maximum to 1.5 GHz -14 dB Maximum to 2.4 GHz

#### MECHANICAL

Life:	30,000 Cycles
-------	---------------

### PATCH AND EQUIPMENT PLUGS:

#### MATERIAL

Insulators:	PTFE
Gaskets:	Silicone Rubber
All Other Metal Parts:	Brass

#### FINISHES

Contacts:	Gold
All Other Parts:	Nickel

#### ELECTRICAL

Impedance:	75 Ohms
Frequency Range:	DC to 2.4 GHz
Voltage Rating:	500 Volts RMS
Return Loss:	-23 dB Maximum to 2.4 GHz

#### MECHANICAL

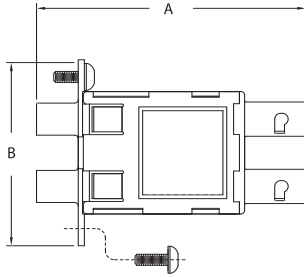
Life:	30,000 Cycles
-------	---------------

### PATCH PANEL:

#### MATERIAL

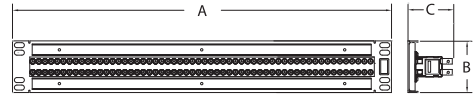
Audio-Video Jacks:	See Specifications for Individual Products
Designation Strip Cover:	Lexan
Screws:	Brass
Face Panel:	Black GE Noryl or Arboron
All Other Metal Parts:	Cold Rolled Steel

**JACK**



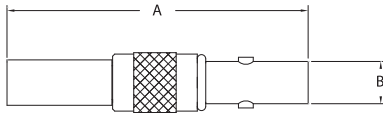
**FIGURE 1**

**JACKFIELD**



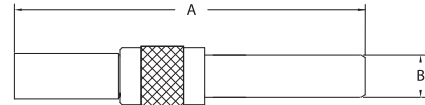
**FIGURE 2**

**EQUIPMENT PLUG**



**FIGURE 3**

**PATCH PLUG**



**FIGURE 4**

Item Number	Military PN	Product Description	Gender	Finish	Dimensions				Cable Group	Cable Procedure	Crimp Die	Mounting Hole	Figure #
					A	B	C	D					
8600-2		Mini Audio/Video Jack, Dual, Terminated	F	Nickel	2.200	1.500							1
8601-1		Mini Audio/Video Jackfield	F		19.000	2.570	2.360						2
8605-3-9		Mini Audio/Video Equipment Plug	M	Nickel	1.430	0.200			26	3-661-6	KTH-2025		3
8608-2-9		Mini Audio/Video Patch Plug	M	Nickel	1.640	0.200			26	3-661-6	KTH-2025		4

## MID-SIZE VIDEO JACKS



- 75 Ohm Nominal Impedance – suitable for Analog, Serial Digital, and HDTV applications.
- Offers higher panel density and increased frequency range.
- Mates with standard BNC plugs and mid-size (0.050" center pin) patch plugs.
- Meets SMPTE 424M (3G-SDI) and HDTV standards.
- Terminated, un-terminated, and feed-through versions available in dual or single configurations.
- Frequency Range: Up to 3.5 GHz

## SPECIFICATIONS

### MATERIAL

Body:	Brass or Zinc Alloy
Contacts:	Beryllium Copper
Springs:	Beryllium Copper
Insulators:	PTFE
Dielectrics:	Topas®

### FINISHES

Body:	Nickel
Contacts:	Gold

### ELECTRICAL

Impedance:	75 Ohms
Frequency Range:	Dual Jacks: DC to 4.1 GHz
	Single Jacks: DC to 3.0 GHz
Return Loss:	Dual Jacks: -20 dB Minimum to 2.4 GHz
	-10 dB Minimum to 4.1 GHz
	Single Jacks: -20 dB Minimum to 1.5 GHz
	(self-terminated) -10 dB Minimum to 3.0 GHz

### MECHANICAL

Life:	30,000+ Cycles
Withdrawal Force:	2.0 Pounds Minimum

### ENVIRONMENTAL

Temperature Range:	-40° C to +85° C
Corrosion:	MIL-STD-202, Method 101
Moisture Resistance:	MIL-STD-202, Method 106

**DUAL**

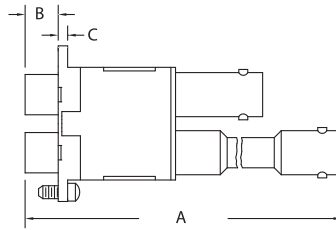


FIGURE 1

**SINGLE**

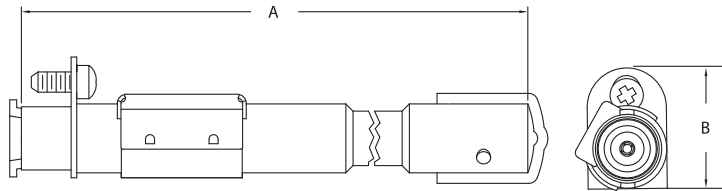


FIGURE 2

Item Number	Military PN	Product Description	Gender	Finish	Dimensions				Cable Group	Cable Procedure	Crimp Die	Mounting Hole	Figure #
					A	B	C	D					
7790-4		Mid-Size, Dual, Feed Through	F-F	Nickel	3.375	0.285	0.081						1
7790-3		Mid-Size, Dual, Non Terminated	F-F	Nickel	3.375	0.285	0.081						1
7790-2		Mid-Size, Dual, Terminated	F-F	Nickel	3.375	0.285	0.081						1
7772-2		Mid-Size, Single, Non Terminated, Long	F-F	Nickel	3.389	0.665							2
7772-1		Mid-Size, Single, Non Terminated, Short	F-F	Nickel	2.060	0.665							2
7772-4		Mid-Size, Single, Terminated, Long	F-F	Nickel	3.389	0.359	0.665						2
7772-3		Mid-Size, Single, Terminated, Short	F-F	Nickel	2.060	0.359	0.665						2

## STANDARD VIDEO JACKS



- 75 Ohm Nominal Impedance – suitable for Analog, Serial Digital, and HDTV applications.
- Mates with standard BNC plugs and standard (0.090" center pin) patch plugs.
- Meets SMPTE 424M and HDTV standards.
- Terminated, un-terminated, and feed-through versions available in dual or single configurations.
- Frequency Range: Up to 3.5 GHz

## SPECIFICATIONS

### MATERIAL

Body:	Zinc Alloy
Contacts:	Beryllium Copper or Brass
Springs:	Beryllium Copper
Insulators:	PTFE or Delrin®
Dielectrics:	Zytel®

### FINISHES

Body:	Nickel
Center Contacts:	Gold

### ELECTRICAL

Impedance:	75 Ohms
Frequency Range:	Dual Jacks: DC to 3.5 GHz Single Jacks: DC to 1.5 GHz
Return Loss:	Dual Jacks: -15 dB Minimum to 2.4 GHz -10 dB Minimum to 3.5 GHz Single Jacks: -18 dB Minimum to 750 MHz (self-terminated) -10 dB Minimum to 1.5 GHz

### MECHANICAL

Life:	50,000 Cycles
Withdrawal Force:	3.0 Pounds Minimum

### ENVIRONMENTAL

Temperature Range:	-40° C to +85° C
Corrosion:	MIL-STD-202, Method 101, Condition B
Moisture Resistance:	MIL-STD-202, Method 106

DUAL

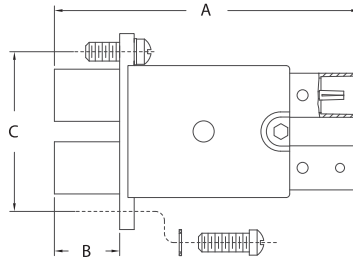


FIGURE 1

SINGLE

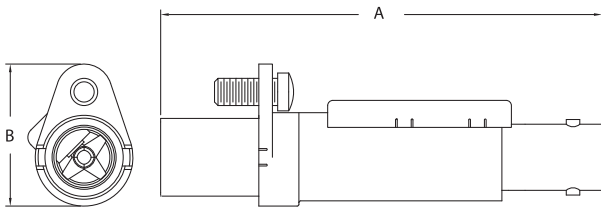


FIGURE 2

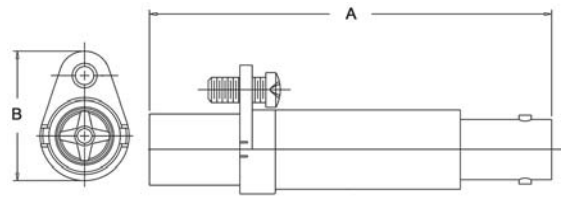


FIGURE 3

Item Number	Military PN	Product Description	Gender	Finish	Dimensions				Cable Group	Cable Procedure	Crimp Die	Mounting Hole	Figure #
					A	B	C	D					
7780-4		Standard Size, Dual, Feed Through	F-F	Nickel	2.650	0.560							1
7780-7		Standard Size, Dual, Feed Through, Threaded Flange	F-F	Nickel	2.650	0.560	1.380						1
7780-3		Standard Size, Dual, Non Terminated	F-F	Nickel	2.650	0.560	1.380						1
7780-6		Standard Size, Dual, Non Terminated, Threaded Flange	F-F	Nickel	2.650	0.560	1.380						1
7780-2		Standard Size, Dual, Terminated	F-F	Nickel	2.650	0.560	1.380						1
7780-5		Standard Size, Dual, Terminated, Threaded Flange	F-F	Nickel	2.650	0.560	1.380						1
7520-10		Standard Size, Single, Terminated	F-F	Nickel	2.540	0.820							2
7520-9		Standard Size, Single, Non Terminated	F-F	Nickel	2.540	0.820							3



## POPULATED VIDEO JACKFIELDS



- 75 Ohm Nominal Impedance – suitable for Analog, Serial Digital, and HDTV applications.
- Industry standard 19" panels pre-populated with KINGS® Brand single or dual video jacks.
- Standard size jacks available in configurations up to 28 circuits across.
- Mid-size jacks available in configurations up to 32 circuits across.
- Terminated, un-terminated, and feed-through versions available.

## SPECIFICATIONS

### MATERIAL

Panels:	Smooth Black Phenolic
Labels:	Designation Strip with Clear Plastic Cover
Video Jacks:	See Specifications for Individual Products

**FEED-THROUGH PANEL - 75 OHM BNC**

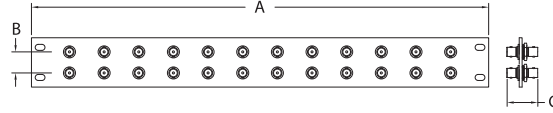


FIGURE 1

**MID-SIZE**

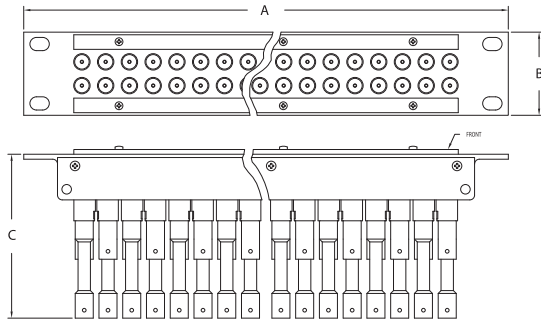


FIGURE 2

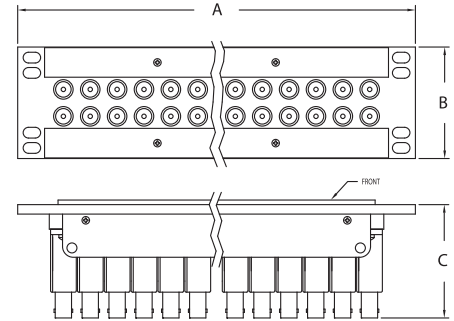


FIGURE 3

Item Number	Military PN	Product Description	Gender	Finish	A	Dimensions B	C	D	Cable Group	Cable Procedure	Crimp Die	Mounting Hole	Figure #
7675-2		75 BNC Feed Through, Single, 1 RU x 10	F		14.000	1.750	1.280						N/S
7676-2		75 BNC Feed Through, Single, 1 RU x 32	F		19.000	1.750	1.280						N/S
7675-5		75 BNC Feed Through, Single, 2 RU x 40	F		19.000	0.820	1.280						1
7795-1		Mid-Size, Dual, Terminated, 1 RU x 24	F		19.000	1.750	3.450						2
7795-11		Mid-Size, Dual, Terminated, 1 RU x 30	F		19.000	1.750	3.450						2
7795-12		Mid-Size, Dual, Terminated, 1 RU x 32	F		19.000	1.750	3.450						2
7795-13		Mid-Size, Dual, Terminated, 1 RU x 34	F		19.000	1.750	3.450						2
7795-27		Mid-Size, Dual, Terminated, 4 RU x 96	F		19.000	7.000	3.600						N/S
7475-21		Mid-Size, Single, Patch-Through, 1RU x 32	F		19.000	1.750	3.450						2
7795-15		Mid-Size, Single, Patch-Through, 1 RU x 34	F		19.000	1.730	3.390						2
7475-22		Mid-Size, Single, Patch-Through, 1.5 RU x 32	F		19.000	2.590	3.450						3
7795-29		Mid-Size, Single, Terminated, 1.5 RU x 32	F		19.000	2.590	3.600						3
7795-17		Mid-Size, Dual, Terminated, 2 RU x 24	F		19.000	3.500	3.450						3
7795-14		Mid-Size, Dual, Terminated, 1.5 RU x 32	F		19.000	2.590	3.600						3

STANDARD SIZE

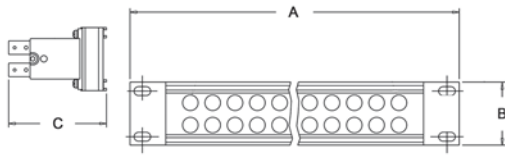


FIGURE 4

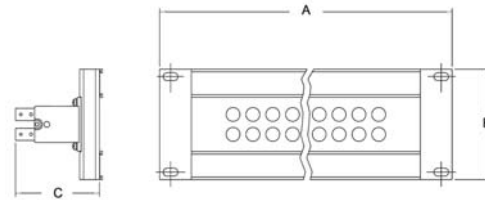


FIGURE 5

Item Number	Military PN	Product Description	Gender	Finish	Dimensions				Cable Group	Cable Procedure	Crimp Die	Mounting Hole	Figure #
					A	B	C	D					
7575-45		Standard Size, Single, Terminated, 1.5 RU x 48	F		19.000	2.590	2.540	15.500					3
7575-46		Standard Size, Single, Terminated, 1.5 RU x 56	F		19.000	2.590	2.540	17.750					3
7785-41		Standard Size, Dual, Terminated, 1.5 RU x 24	F		19.000	2.590	2.650	15.500					3
7785-40		Standard Size, Dual, Terminated, 1.5 RU x 28	F		19.000	2.590	2.640	17.750					3
7785-42		Standard Size, Dual, Feed Through, 1 RU x 24	F		19.000	1.750	2.800						4
7785-29		Standard Size, Dual, Non Terminated, 1 RU x 24	F		19.000	1.750	2.800						4
7785-31		Standard Size, Dual, Non Terminated, 1 RU x 26	F		19.000	1.750	2.800						4
7785-6		Standard Size, Dual, Terminated, 1 RU x 24	F		19.000	1.750	2.800						4
7785-7		Standard Size, Dual, Terminated, 1 RU x 26	F		19.000	1.750	2.800						4
7575-13		Standard Size, Single, Terminated, 1 RU x 24	F		19.000	1.750	2.620						4
7575-24		Standard Size, Single, Terminated, 1 RU x 48	F		19.000	1.750	2.620						4
7575-47		Standard Size, Single, Terminated, 1 RU x 52	F		19.000	1.750	2.620						4
7575-21		Standard Size, Single, Non Terminated, 1 RU x 48	F		19.000	1.750	2.620						4
7785-8		Standard Size, Dual, Terminated, 2 RU x 24	F		19.000	3.500	2.800						5
7785-4		Standard Size, Dual, Terminated, 2 RU x 26	F		19.000	3.500	2.800						5
7785-5		Standard Size, Dual, Terminated, 2 RU x 26	F		19.000	3.500	2.800						5
7785-32		Standard Size, Dual, Non Terminated, 2 RU x 24	F		19.000	3.500	2.800						5
7785-30		Standard Size, Dual, Non Terminated, 2 RU x 26	F		19.000	3.500	2.800						5
7785-27		Standard Size, Dual, Terminated, 4 RU x 75	F		19.000	7.000	2.620						N/S
7575-18		Standard Size, Single, Non Terminated, 2 RU x 48	F		19.000	3.500	2.800						5
7575-15		Standard Size, Single, Terminated, 2 RU x 48	F		19.000	3.500	2.620						5
7575-26		Standard Size, Single, Terminated, 4 RU x 150	F		19.000	7.000	2.620						N/S



**STRAIN RELIEF BOOTS**

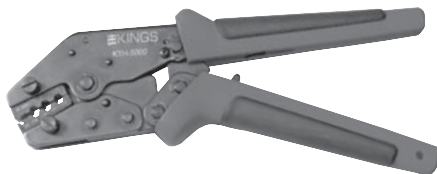
- Protects from wear, fatigue, and weather.
- Designed to fit a variety of industry-leading broadcast cables.
- Available in 10 popular colors.



KTH-1000

**HAND CRIMPING TOOL**

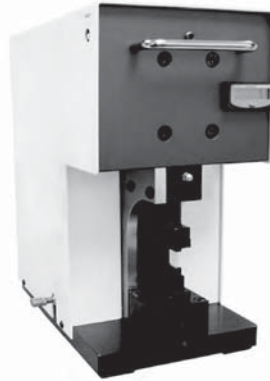
- Field-tested and approved - an industry favorite.
- Ratchet-type tool does not release until crimp is complete.
- Robust and reliable - frame made of heavy-duty, lightweight aluminum.
- Interchangeable dies available to fit a variety of connector and cable types.



KTH-5000

**HAND CRIMPING TOOL**

- Economical and user-friendly alternative to other industrial crimping tools.
- Lightweight, ergonomic tool allows for one-handed operation.
- Ultra-smooth ratchet design with rubber grip handles.
- Available dies developed specifically for precise crimping of KINGS® connectors.



KTM-5000

**PNEUMATIC CRIMPING MACHINE**

- Portable, bench-mounted with no permanent lines attached.
- Designed for use with KINGS® KTH-1000 and KTH-2000 die sets.
- Ideal for long or short production runs.
- Convenient foot control frees operator hands for crimping.
- Quick and easy changing from one die to another.
- Pneumatic interlock feature guarantees constant crimping.
- Designed with OSHA safety requirements in mind.
- Low maintenance.



KTS-8-1 AND KTS-8-2

**MANUAL STRIPPING TOOLS**

- Hand-held tool is lightweight and compact - ideal for field use.
- Blade cassettes and memory blocks interchange quickly and easily.
- Cam adjustment ensures precise hold on cable without distorting the jacket.
- KTS-8-1 is designed specifically for the Belden 179 DT Cable.
- KTS-8-2 is adjustable for use in most two- and three-piece BNC applications.

STRAIN RELIEF BOOTS

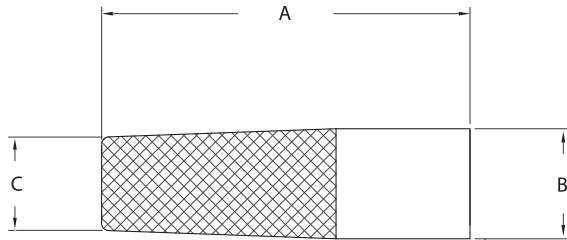


FIGURE 1

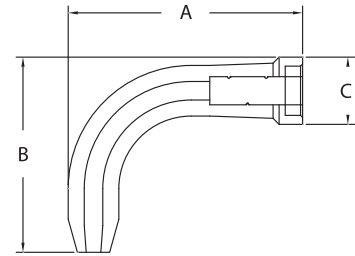
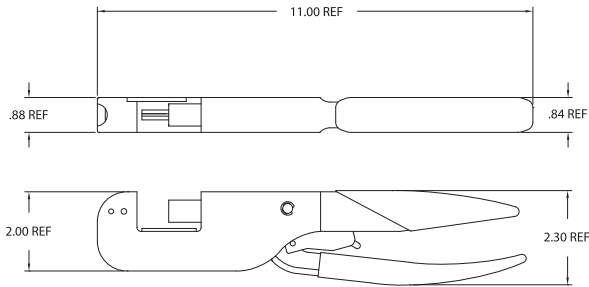


FIGURE 2

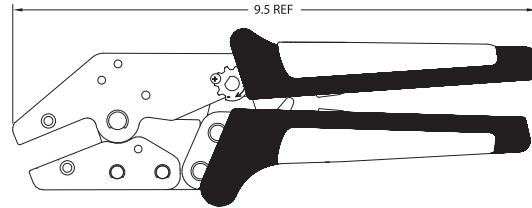
Item Number	Military PN	Product Description	Gender	Finish	Dimensions				Cable Group	Cable Procedure	Crimp Die	Mounting Hole	Figure #
					A	B	C	D					
1-8065-1		Boot for 735 Cable, Brown			1.520	0.442	0.324		31				1
1-8065-2		Boot for 735 Cable, Red			1.520	0.442	0.324		31				1
1-8065-3		Boot for 735 Cable, Orange			1.520	0.442	0.324		31				1
1-8065-4		Boot for 735 Cable, Yellow			1.520	0.442	0.324		31				1
1-8065-5		Boot for 735 Cable, Green			1.520	0.442	0.324		31				1
1-8065-6		Boot for 735 Cable, Blue			1.520	0.442	0.324		31				1
1-8065-7		Boot for 735 Cable, Violet			1.520	0.442	0.324		31				1
1-8065-8		Boot for 735 Cable, Grey			1.520	0.442	0.324		31				1
1-8065-9		Boot for 735 Cable, White			1.520	0.442	0.324		31				1
1-8065-10		Boot for 735 Cable, Black			1.520	0.442	0.324		31				1
1-8066-1		Boot for 734 Cable, Brown			1.520	0.442	0.324		30				1
1-8066-2		Boot for 734 Cable, Red			1.520	0.442	0.324		30				1
1-8066-3		Boot for 734 Cable, Orange			1.520	0.442	0.324		30				1
1-8066-4		Boot for 734 Cable, Yellow			1.520	0.442	0.324		30				1
1-8066-5		Boot for 734 Cable, Green			1.520	0.442	0.324		30				1
1-8066-6		Boot for 734 Cable, Blue			1.520	0.442	0.324		30				1
1-8066-7		Boot for 734 Cable, Violet			1.520	0.442	0.324		30				1
1-8066-8		Boot for 734 Cable, Grey			1.520	0.442	0.324		30				1
1-8066-9		Boot for 734 Cable, White			1.520	0.442	0.324		30				1
1-8066-10		Boot for 734 Cable, Black			1.520	0.442	0.324		30				1
1-8114-1 QD		Boot for 1694A Cable, Brown			1.540	0.460	0.390		25				1
1-8114-2 QD		Boot for 1694A Cable, Red			1.540	0.460	0.390		25				1
1-8114-3 QD		Boot for 1694A Cable, Orange			1.540	0.460	0.390		25				1
1-8114-4 QD		Boot for 1694A Cable, Yellow			1.540	0.460	0.390		25				1
1-8114-5 QD		Boot for 1694A Cable, Green			1.540	0.460	0.390		25				1
1-8114-6 QD		Boot for 1694A Cable, Blue			1.540	0.460	0.390		25				1
1-8114-7 QD		Boot for 1694A Cable, Violet			1.540	0.460	0.390		25				1
1-8114-8 QD		Boot for 1694A Cable, Grey			1.540	0.460	0.390		25				1
1-8114-9 QD		Boot for 1694A Cable, White			1.540	0.460	0.390		25				1
1-8114-10 QD		Boot for 1694A Cable, Black			1.540	0.460	0.390		25				1
1-8115-1 QD		Boot for 1855A Cable, Brown			1.540	0.460	0.347		26				1
1-8115-2 QD		Boot for 1855A Cable, Red			1.540	0.460	0.347		26				1
1-8115-3 QD		Boot for 1855A Cable, Orange			1.540	0.460	0.347		26				1
1-8115-4 QD		Boot for 1855A Cable, Yellow			1.540	0.460	0.347		26				1
1-8115-5 QD		Boot for 1855A Cable, Green			1.540	0.460	0.347		26				1
1-8115-6 QD		Boot for 1855A Cable, Blue			1.540	0.460	0.347		26				1

Item Number	Military PN	Product Description	Gender	Finish	Dimensions				Cable Group	Cable Procedure	Crimp Die	Mounting Hole	Figure #
					A	B	C	D					
1-8115-7 QD		Boot for 1855A Cable, Violet			1.540	0.460	0.347		26				1
1-8115-8 QD		Boot for 1855A Cable, Grey			1.540	0.460	0.347		26				1
1-8115-9 QD		Boot for 1855A Cable, White			1.540	0.460	0.347		26				1
1-8115-10 QD		Boot for 1855A Cable, Black			1.540	0.460	0.347		26				1
1-8574-1		Boot for 179DT Cable, Brown			1.520	0.442	0.324		23				1
1-8574-2		Boot for 179DT Cable, Red			1.520	0.442	0.324		23				1
1-8574-3		Boot for 179DT Cable, Orange			1.520	0.442	0.324		23				1
1-8574-4		Boot for 179DT Cable, Yellow			1.520	0.442	0.324		23				1
1-8574-5		Boot for 179DT Cable, Green			1.520	0.442	0.324		23				1
1-8574-6		Boot for 179DT Cable, Blue			1.520	0.442	0.324		23				1
1-8574-7		Boot for 179DT Cable, Violet			1.520	0.442	0.324		23				1
1-8574-8		Boot for 179DT Cable, Grey			1.520	0.442	0.324		23				1
1-8574-9		Boot for 179DT Cable, White			1.520	0.442	0.324		23				1
1-8574-10		Boot for 179DT Cable, Black			1.520	0.442	0.324		23				1
1-8575-1 QD		Boot for RG-174 Cable, Brown			1.520	0.442	0.324		B1				1
1-8575-2 QD		Boot for RG-174 Cable, Red			1.520	0.442	0.324		B1				1
1-8575-3 QD		Boot for RG-174 Cable, Orange			1.520	0.442	0.324		B1				1
1-8575-4 QD		Boot for RG-174 Cable, Yellow			1.520	0.442	0.324		B1				1
1-8575-5 QD		Boot for RG-174 Cable, Green			1.520	0.442	0.324		B1				1
1-8575-6 QD		Boot for RG-174 Cable, Blue			1.520	0.442	0.324		B1				1
1-8575-7 QD		Boot for RG-174 Cable, Violet			1.520	0.442	0.324		B1				1
1-8575-8 QD		Boot for RG-174 Cable, Grey			1.520	0.442	0.324		B1				1
1-8575-9 QD		Boot for RG-174 Cable, White			1.520	0.442	0.324		B1				1
1-8575-10 QD		Boot for RG-174 Cable, Black			1.520	0.442	0.324		B1				1
1-8576-1 QD		Boot for RG-58 Cable, Brown			1.520	0.442	0.324		D				1
1-8576-2 QD		Boot for RG-58 Cable, Red			1.520	0.442	0.324		D				1
1-8576-3 QD		Boot for RG-58 Cable, Orange			1.520	0.442	0.324		D				1
1-8576-4 QD		Boot for RG-58 Cable, Yellow			1.520	0.442	0.324		D				1
1-8576-5 QD		Boot for RG-58 Cable, Green			1.520	0.442	0.324		D				1
1-8576-6 QD		Boot for RG-58 Cable, Blue			1.520	0.442	0.324		D				1
1-8576-7 QD		Boot for RG-58 Cable, Violet			1.520	0.442	0.324		D				1
1-8576-8 QD		Boot for RG-58 Cable, Grey			1.520	0.442	0.324		D				1
1-8576-9 QD		Boot for RG-58 Cable, White			1.520	0.442	0.324		D				1
1-8576-10 QD		Boot for RG-58 Cable, Black			1.520	0.442	0.324		D				1
1-8577-1 QD		Boot for RG-59 Cable, Brown			1.540	0.460	0.359		G1				1
1-8577-2 QD		Boot for RG-59 Cable, Red			1.540	0.460	0.359		G1				1
1-8577-3 QD		Boot for RG-59 Cable, Orange			1.540	0.460	0.359		G1				1
1-8577-4 QD		Boot for RG-59 Cable, Yellow			1.540	0.460	0.359		G1				1
1-8577-5 QD		Boot for RG-59 Cable, Green			1.540	0.460	0.359		G1				1
1-8577-6 QD		Boot for RG-59 Cable, Blue			1.540	0.460	0.359		G1				1
1-8577-7 QD		Boot for RG-59 Cable, Violet			1.540	0.460	0.359		G1				1
1-8577-8 QD		Boot for RG-59 Cable, Grey			1.540	0.460	0.359		G1				1
1-8577-9 QD		Boot for RG-59 Cable, White			1.540	0.460	0.359		G1				1
1-8577-10 QD		Boot for RG-59 Cable, Black			1.540	0.460	0.359		G1				1
1-8603		Right Angle Boot for 735 Cable, Blue			1.710	1.420	0.470		31				2

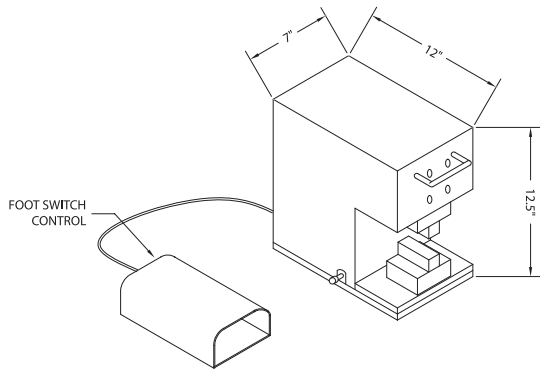
**INSTALLATION TOOLS**



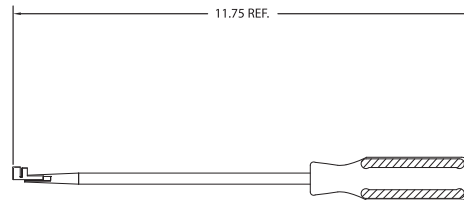
**FIGURE 1**



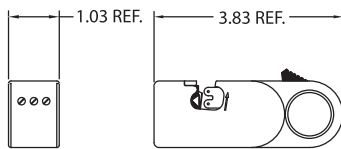
**FIGURE 2**



**FIGURE 3**



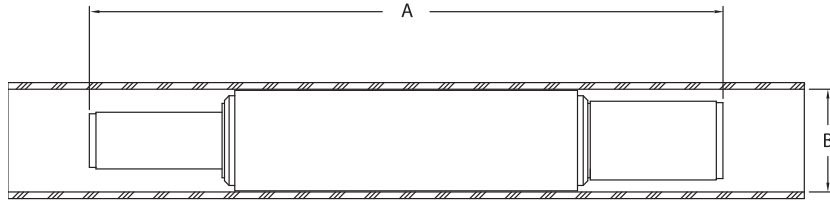
**FIGURE 4**



**FIGURE 5**

Item Number	Military PN	Product Description	Gender	Finish	Dimensions				Cable Group	Cable Procedure	Crimp Die Sets	Figure #
					A	B	C	D				
KTH-1000		Crimping Tool, Manual								KTH-1000 or KTH-2000	1	
KTH-5000		Crimping Tool, Manual								KTH-5000	2	
KTM-5000		Crimping Tool, Pneumatic								KTH-1000 or KTH-2000	3	
KTW-13		Miniature A/V Insertion and Removal Tool									4	
KTS-8-1		Stripping Tool, Manual, 179DT Cable									5	
KTS-8-2		Stripping Tool, Manual, Adjustable									5	

**SPLICES**

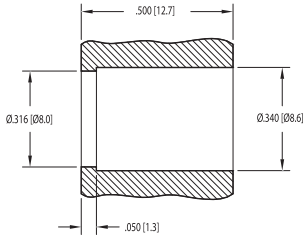


**FIGURE 1**

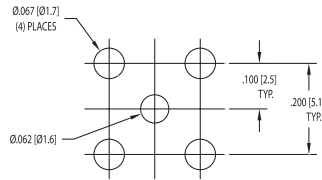
Item Number	Military PN	Product Description	Gender	Finish	Dimensions				Cable Group	Cable Procedure	Crimp Die	Mounting Hole	Figure #
					A	B	C	D					
3050-10-9		Cable Splice, 735-734	NONE	Nickel	2.400	0.390			30,31	3-661-5	KTH-2185 KTH-2186		1
3050-11-9		Cable Splice, 735-735	NONE	Nickel	2.400	0.390			31	3-661-5	KTH-2185		1
3050-12-9		Cable Splice, 734-734	NONE	Nickel	2.400	0.390			30	3-661-5	KTH-2186		1



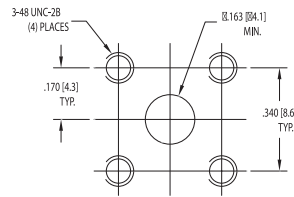
# MOUNTING HOLES



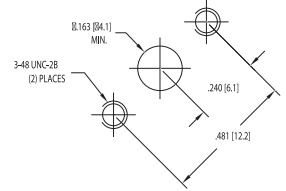
**MOUNTING HOLE A**



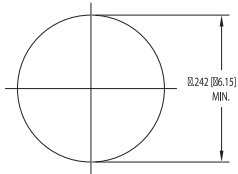
**MOUNTING HOLE B**



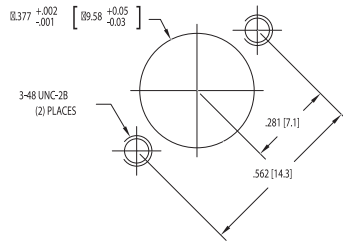
**MOUNTING HOLE C**



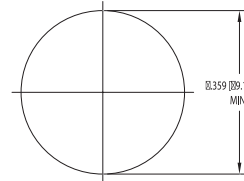
**MOUNTING HOLE D**



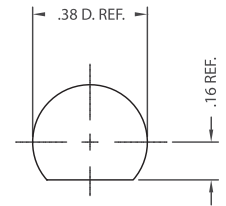
**MOUNTING HOLE E**



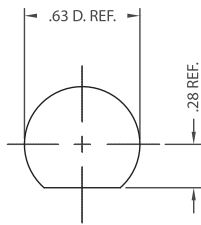
**MOUNTING HOLE F**



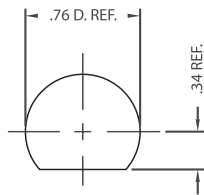
**MOUNTING HOLE G**



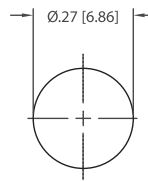
**MOUNTING HOLE H**



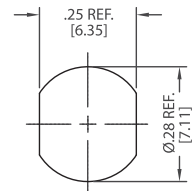
**MOUNTING HOLE I**



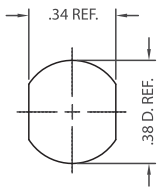
**MOUNTING HOLE J**



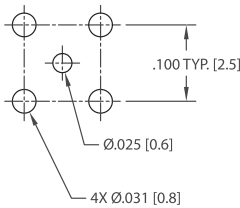
**MOUNTING HOLE K**



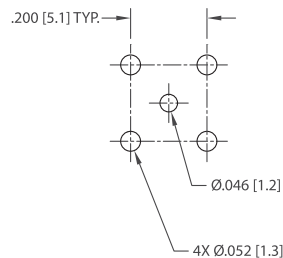
**MOUNTING HOLE L**



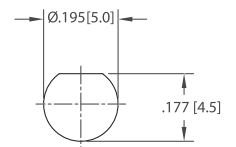
**MOUNTING HOLE M**



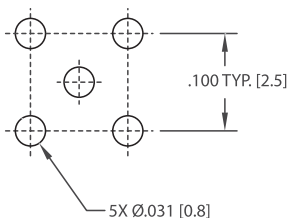
**MOUNTING HOLE N**



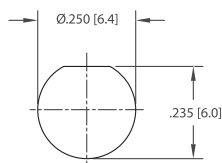
**MOUNTING HOLE O**



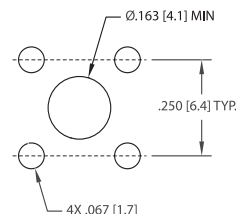
**MOUNTING HOLE P**



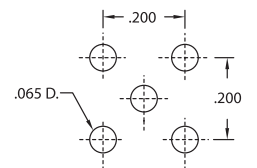
**MOUNTING HOLE Q**



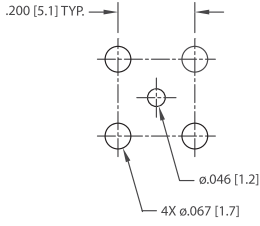
**MOUNTING HOLE R**



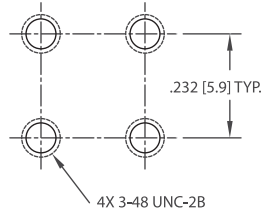
**MOUNTING HOLE S**



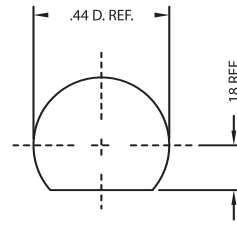
**MOUNTING HOLE T**



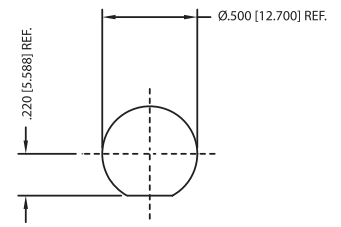
**MOUNTING HOLE U**



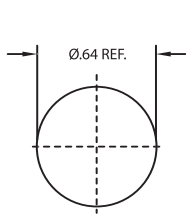
**MOUNTING HOLE V**



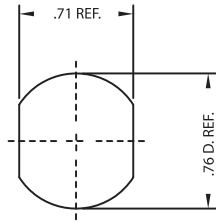
**MOUNTING HOLE W**



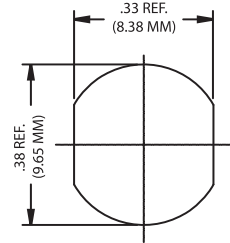
**MOUNTING HOLE X**



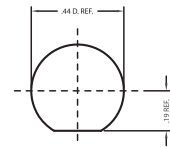
**MOUNTING HOLE Y**



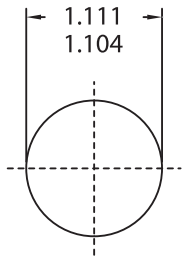
**MOUNTING HOLE Z**



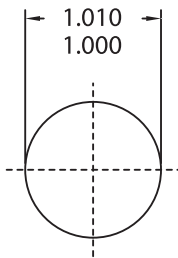
**MOUNTING HOLE AA**



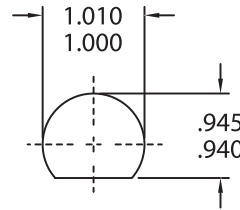
**MOUNTING HOLE AB**



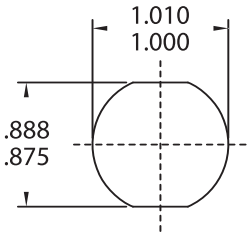
**MOUNTING HOLE AC**



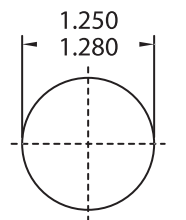
**MOUNTING HOLE AD**



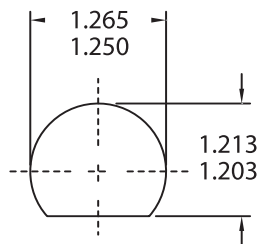
**MOUNTING HOLE AE**



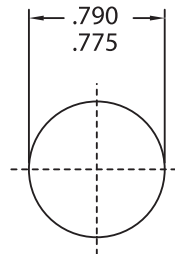
**MOUNTING HOLE AF**



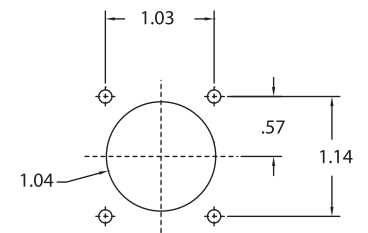
**MOUNTING HOLE AG**



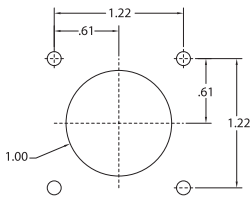
**MOUNTING HOLE AH**



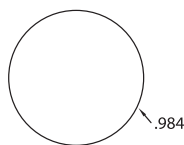
**MOUNTING HOLE AI**



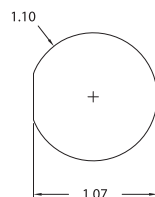
**MOUNTING HOLE AJ**



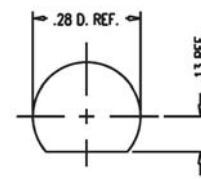
**MOUNTING HOLE AK**



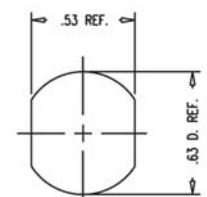
**MOUNTING HOLE AL**



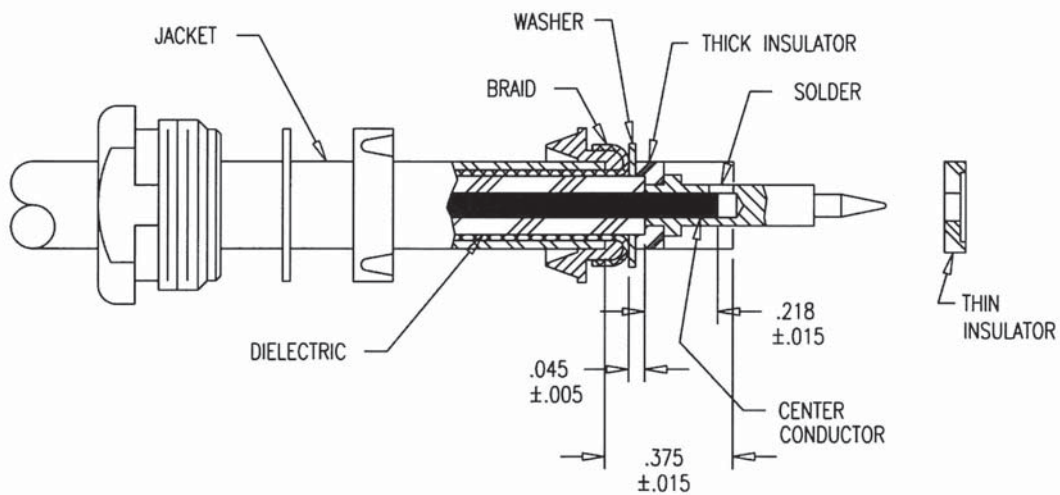
**MOUNTING HOLE AM**



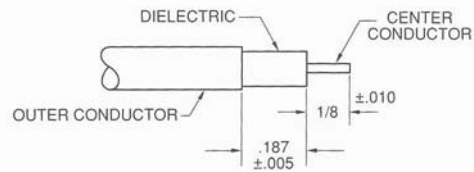
**MOUNTING HOLE AN**



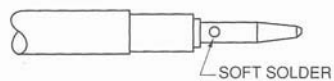
**MOUNTING HOLE AO**



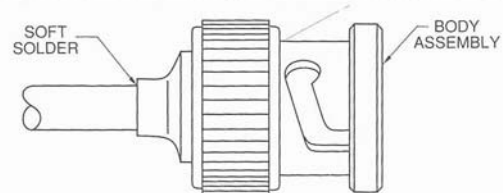
1. WITH CLAMP NUT, SLIP WASHER & GASKET ON CABLE, REMOVE JACKET TO  $.375 \pm .015$  DIM.
  2. SLIDE BRAID CLAMP OVER BRAID AGAINST JACKET EDGE. COMB OUT BRAID WIRES, FOLD BACK OVER BRAID CLAMP & TRIM AS SHOWN.
  3. REMOVE DIELECTRIC TO  $.045 \pm .005$  DIM. & TRIM CENTER CONDUCTOR TO  $.218 \pm .015$  DIM.
  4. SLIDE WASHER OVER DIELECTRIC & AGAINST BRAID. PLACE THICK INSULATOR ON CONTACT & ASSEMBLE ON CABLE CENTER CONDUCTOR WITH DIELECTRIC BOTTOMED IN C'BORE AND SOLDER CONTACT IN POSITION. (DO NOT OVERHEAT)
  5. ASSEMBLE THIN INSULATOR ON CONTACT WITH C'BORE TOWARD CONTACT TIP & THREAD ASSEMBLY SECURELY INTO CONNECTOR BODY.
- RECOMMENDED TORQUE: 55-60 IN. LBS.



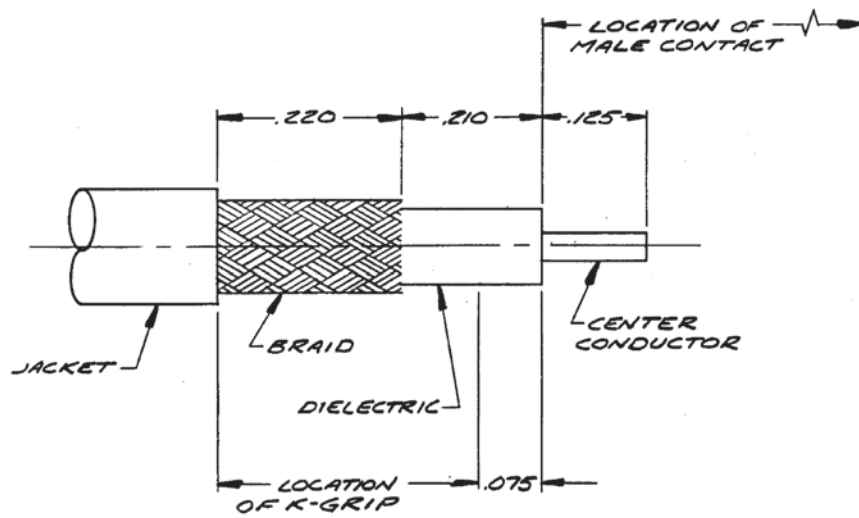
1. Remove outer conductor and dielectric to dimensions shown. (Care must be taken to remove all metal particles from dielectric surfaces.)

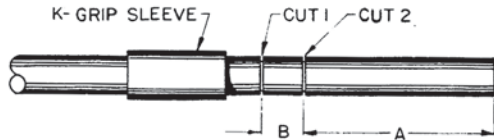


2. Assemble center contact in position against dielectric face & soft solder.



3. Place solder preform on cable, insert cable into body assembly until bottomed, hold in place and solder. (Apply a small amount of non-acid flux and heat at point directly behind body assembly on outer conductor.)





1. Cut cable end square, slide shrink tubing and K-grip sleeve over jacket and with jacket trim jig make cuts 1 and 2 in jacket.



2. Remove jacket to dimension "A", flare or bluge back braid and trim with scissors at edge of jacket.



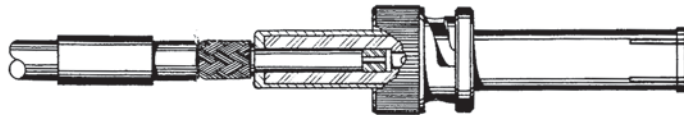
3. Remove jacket to dimension "B."



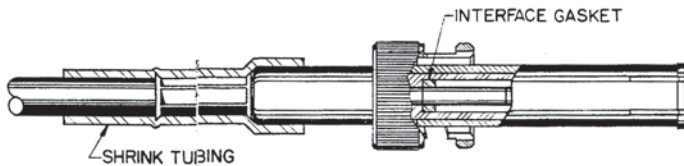
4. Using dielectric trim jig, trim dimension "C." Exposed center conductor length will be equal to dimension "D" of trim code.



5. Place cable seal gasket over center conductor against dielectric then solder contact to center conductor. Gasket must be under compression after soldering is completed.



6. Push connector over dielectric and under braid until contact bottoms in insulator.



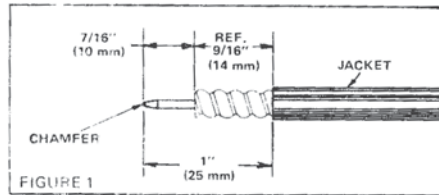
7. Slide K-grip sleeve over K-grip and braid to within 1/64 inch of shoulder of body and form hex. Then place tubing in position and shrink onto body and cable by heating (300°F Max). Install interface gasket over contact. (When Supplied) When Weatherproof Sleeve is used Heat Shrink Tubing is not required.

UNLESS OTHERWISE SPECIFIED:

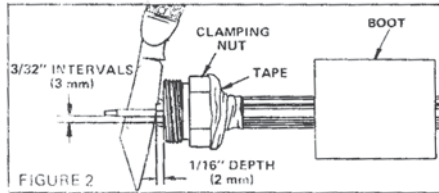
- 1. TOLERANCES: FRACTIONS ± .010 DECIMALS ± .004 ANGLES ± 0° 30'
- 2. REMOVE ALL BURRS, BREAK SHARP EDGES .005 MAX.
- 3. NO FILLETS PERMITTED.
- 4. SURFACE ROUGHNESS 63 MICRONS RMS MAX.
- 5. ALL DIMENSIONS PRIOR TO PLATING.

DASH NO.	TRIM CODE	TRIM DIMENSIONS			
		A	B	C	D
-1	CP474	15/16	3/16	.890	15/64
-2	CP475	1 3/4	3/16	1.627	5/16
-3	CP476	2 35/64	3/16	2.415	5/16
-4	CP489	1	3/16	.948	15/64

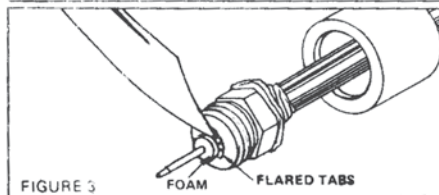
**STEP 1.** Prepare cable as shown in Figure 1. Cable end must be square. If it is not, use hacksaw to make new cut. Wrap tape around cable to guide jacketing cut. Remove jacket with knife. Cut off outer conductor and foam with hacksaw. Do not damage inner conductor. Use file to remove burrs and chamfer end of inner conductor. Clean exposed inner conductor of foam particles with garnet cloth. Wire brush copper particles from foam.



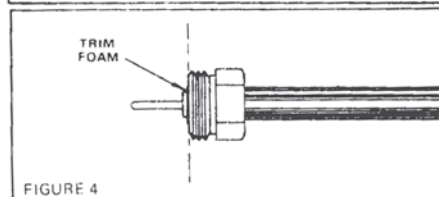
**STEP 2.** Place boot and clamping nut on cable with opening of boot toward cable end. See Figure 2. Secure clamping nut in place with tape, exposing outer conductor to dimension shown. Cut tabs into outer conductor to depth and intervals shown. Use mallet to tap knife. Use clamping nut as stop for knife.



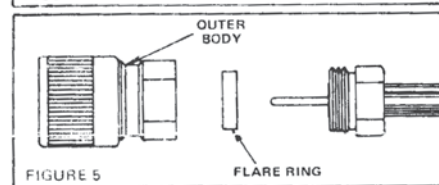
**STEP 3.** Turn tabs up 90 degrees with point of knife as shown in Figure 3. Remove tape from clamping nut.



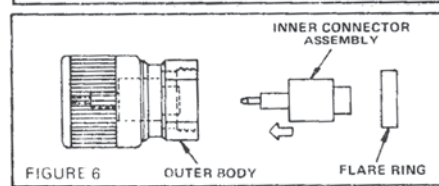
**STEP 4.** Cut off foam flush with flared outer conductor. Do not cut into inner conductor. See Figure 4. Remove all copper particles from foam.



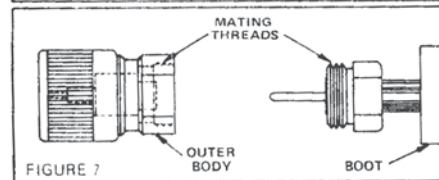
**STEP 5.** Add flare ring and outer body as shown in Figure 5. Screw outer body to clamping nut and tighten to compress flared tabs against clamping nut. Turn outer body only; do not turn clamping nut. Disassemble connector and inspect flare for regularity and tightness to clamping nut.



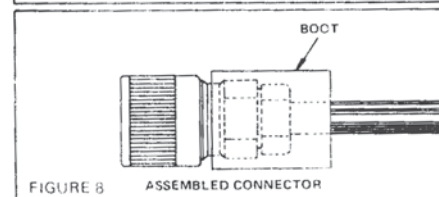
**STEP 6.** Seat inner connector assembly and flare ring into outer body. Refer to Figure 6. Inner assembly must be fully inserted into outer body as indicated by dotted lines.

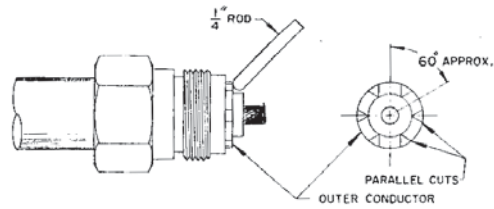
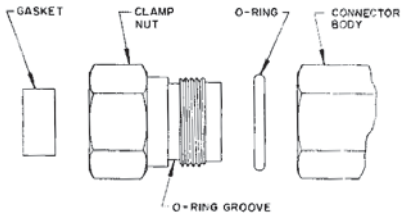


**STEP 7.** Slide outer body onto inner connector and screw it to clamping nut. Tighten connection. Turn outer body only; do not turn clamping nut. See Figure 7.

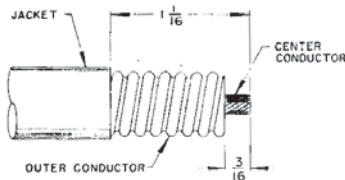


**STEP 8.** Place boot over assembly and seat it in groove of outer body. Refer to assembled connector in Figure 8.

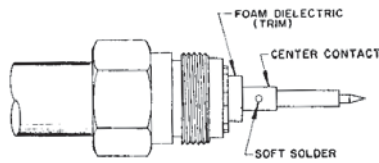




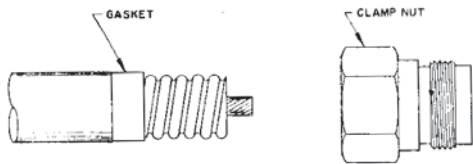
USING A KNIFE AND Mallet MAKE 6 CUTS IN THE CABLE. MAKE THE CUTS BY PLACING THE KNIFE AGAINST THE CENTER CONDUCTOR AND CUTTING TOWARD AND UP TO THE CLAMP NUT FACE. MAKE 2 PARALLEL CUTS, ONE ON EACH SIDE OF THE CENTER CONDUCTOR AND THEN MAKE 4 MORE CUTS AT 60 DEG. TO THE FIRST TWO CUTS AS SHOWN. WITH THE TIP OF THE KNIFE BEND EACH OF THE SECTIONS OF THE OUTER CONDUCTOR FORWARD. TAP SECTIONS AGAINST CLAMP NUT WITH Mallet AND 1/4 INCH NON-METALLIC ROD. DO NOT FLATTEN TABS, REDUCING MATERIAL THICKNESS. TRIM EXCESS TAB MATERIAL FLUSH WITH OUTER DIAMETER OF CLAMP NUT.



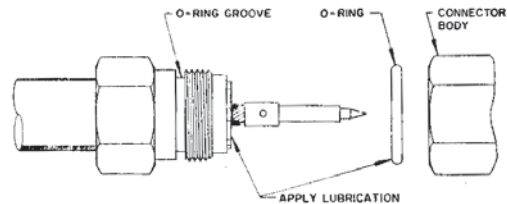
CUT CABLE END SQUARE. TRIM JACKET TO 1/16 DIM. TAKING CARE THAT JACKET END IS SQUARE. CUT OUTER CONDUCTOR AND FOAM DIELECTRIC TO 3/16 DIM. CAREFUL NOT TO NICK CENTER CONDUCTOR.



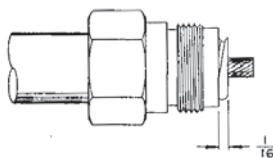
TIN CENTER CONDUCTOR AND ROUND OFF END. SLIDE CENTER CONTACT ONTO CENTER CONDUCTOR AND AGAINST DIELECTRIC. SOLDER IN PLACE, BEING CAREFUL NOT TO APPLY EXCESS HEAT AND NOT TO PUSH CONTACT INTO FOAM DIELECTRIC. TRIM DIELECTRIC FLUSH WITH FACE OF OUTER CONDUCTOR.



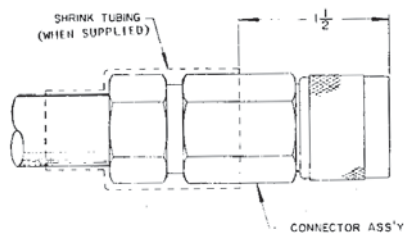
SLIDE GASKET ONTO OUTER CONDUCTOR AS SHOWN. APPLY A THIN COATING OF SILICONE GREASE TO OUTSIDE OF GASKET AND INSIDE SURFACE OF CLAMP NUT.



REMOVE ALL COPPER PARTICLES FROM DIELECTRIC AND SEAL EXPOSED DIELECTRIC WITH SILICONE GREASE. APPLY SILICONE GREASE TO O-RING AND INSTALL IN GROOVE ON CLAMP NUT. THREAD CONNECTOR BODY ONTO CLAMP NUT AND TIGHTEN SECURELY MAKING SURE THE CLAMP NUT IS HELD STATIONARY.

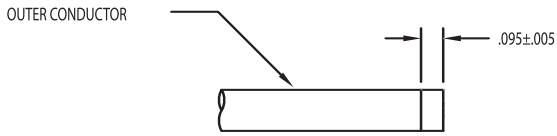


THREAD CLAMP NUT ONTO CONDUCTOR UNTIL OUTER CONDUCTOR IS EXPOSED 1/16.

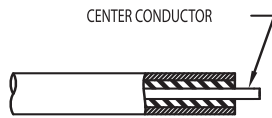


SLIDE SHRINK TUBING OVER ASSEMBLED CONNECTOR AS SHOWN AND APPLY JUST ENOUGH HEAT TO SHRINK TUBING TO OBTAIN A TIGHT SEAL. DO NOT OVERHEAT.

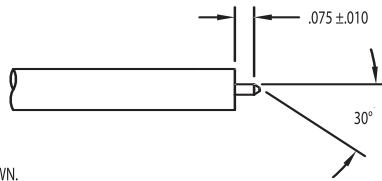




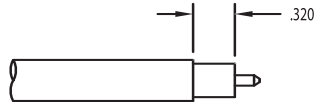
1. CUT CABLE END SQUARE & SCORE OUTER CONDUCTOR ALL AROUND TO DIMENSION SHOWN.



2. REMOVE JACKET TO SCORED MARK. THEN REMOVE DIELECTRIC TO FRONT FACE OF OUTER CONDUCTOR MAKING SURE SURFACE IS SQUARE & FREE OF BURRS. DO NOT NICK CENTER CONDUCTOR.

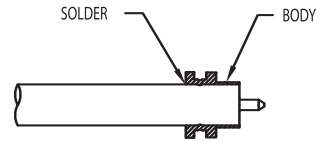


3. CHAMFER CENTER TO 30° AS SHOWN.



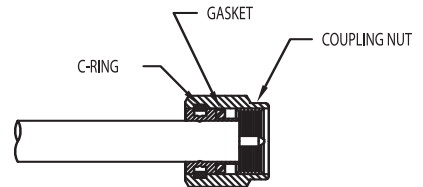
3A. WHEN USING T-FLEX402HF CABLE: SOLDER DIP CABLE PER SHEET 2 OF 3-648. BEFORE STARTING TO TRIM CABLE. TRIM JACKET TO DIMENSION SHOWN.

4. STEPS 1 THRU 3 MAY BE ACCOMPLISHED WITH EASE AND ACCURACY USING KINGS KTO-2 STRIPPING TOOL FOR RG-402/U (.141) CABLE.

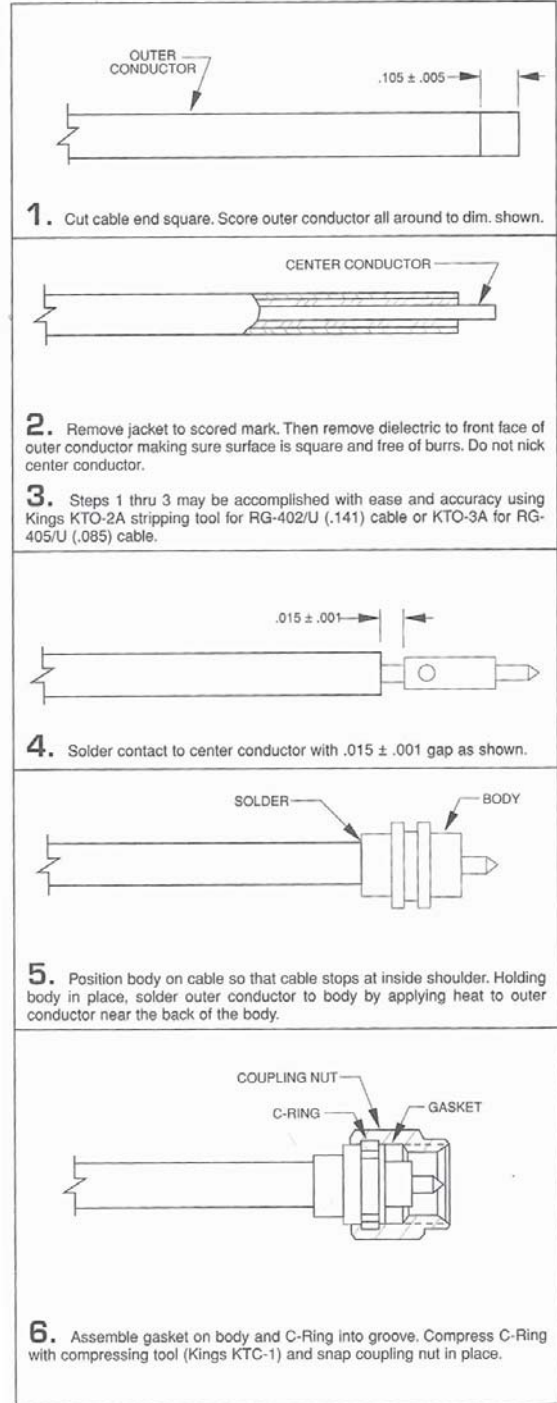


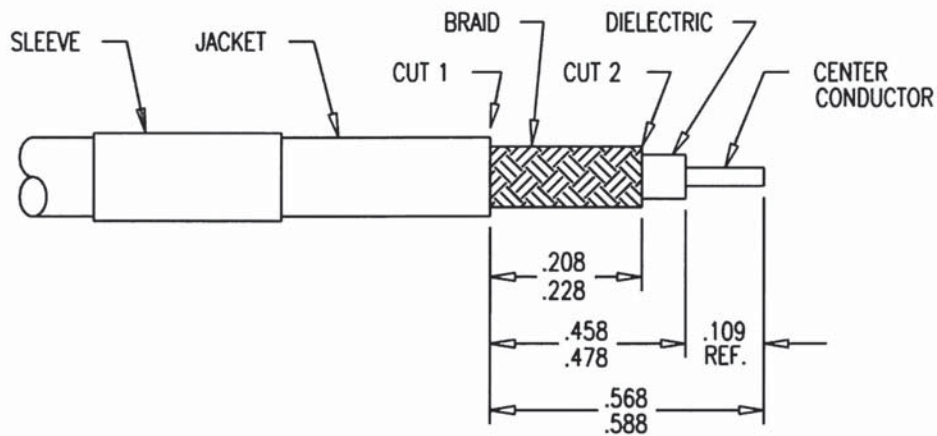
5. POSITION BODY ON CABLE SO THAT FRONT FACES OF BODY & TRIMMED CABLE ARE FLUSH. HOLDING BODY IN PLACE, SOLDER OUTER CONDUCTOR TO BODY BY APPLYING HEAT TO OUTER CONDUCTOR NEAR THE BACK OF THE BODY.

6. REMOVE ANY EXCESS DIELECTRIC THAT MAY EXTRUDE FROM CABLE DUE TO HEAT SO THAT DIELECTRIC IS FLUSH AGAIN WITH OUTER CONDUCTOR OF CABLE & CONNECTOR BODY.

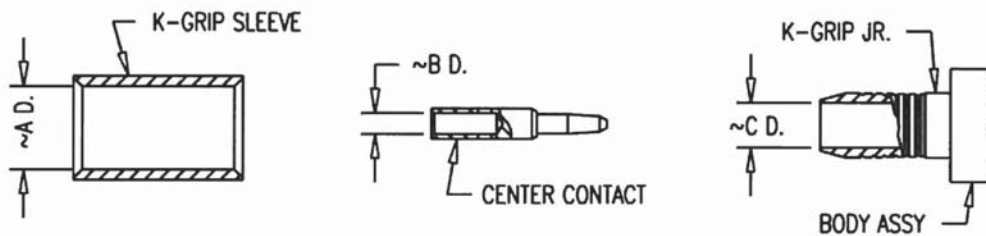


7. ASSEMBLE GASKET ON BODY AND C-RING INTO GROOVE. COMPRESS C-RING WITH COMPRESSING TOOL (KINGS KTC-1) AND SNAP COUPLING NUT IN PLACE.





1. CUT CABLE END SQUARE. SLIDE K-GRIP SLEEVE OVER JACKET AND MAKE CUTS 1 AND 2 THROUGH JACKET ONLY.
2. REMOVE END OF JACKET UP TO CUT 2, FLARE OR BULGE BACK BRAID AND TRIM WITH SCISSORS AT EDGE OF JACKET.
3. REMOVE JACKET BETWEEN CUTS 1 AND 2 EXPOSING .218 ±.010 LENGTH OF BRAID.
4. TRIM DIELECTRIC TO .468 ±.010 DIM., EXPOSED CENTER CONDUCTOR WILL BE .109 REF.
5. PLACE CENTER CONTACT ON CABLE AGAINST DIELECTRIC AND CRIMP OR SOLDER IN PLACE.
6. PUSH K-GRIP JR. OVER DIELECTRIC AND UNDER BRAID UNTIL DIELECTRIC BOTTOMS IN CONNECTOR.
7. SLIDE K-GRIP SLEEVE OVER K-GRIP JR. AND BRAID TO SHOULDER OF BODY ASSEMBLY AND FORM HEX USING APPLICABLE CRIMP TOOL AND DIE.



MILITARY PART NO.	KINGS PART NO.	PIECE PART DIMS			* KINGS DIE SIZE
		A	B	C	
M39012/20-0002	KC-59-197	.207	.042	.122	2061
M39012/20-0003	KC-59-246	.220			

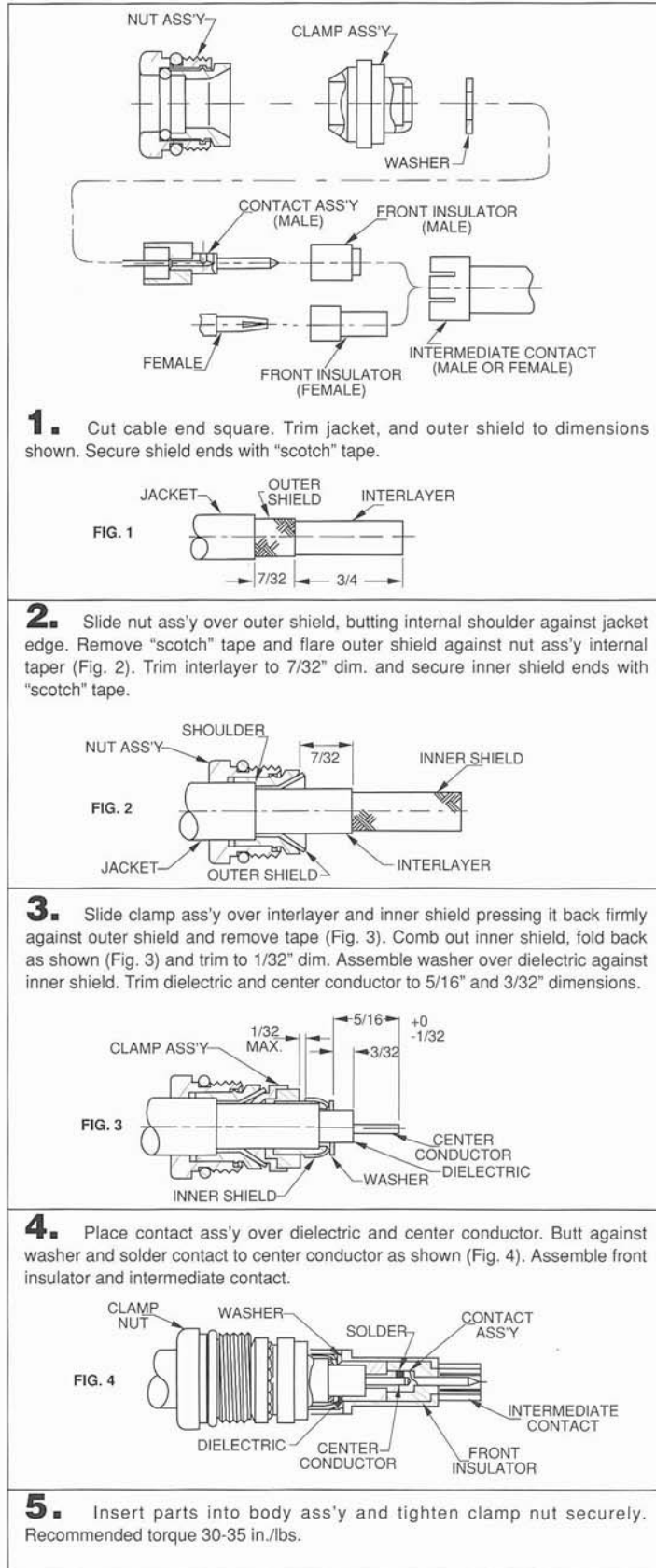
**1.** Trim cable to dimension shown. Recommended tooling: KTO-3A (ROTO-STRIP) for .085 S.R. Cable or KTO-2A (ROTO-STRIP) for .141 S.R. Cable.

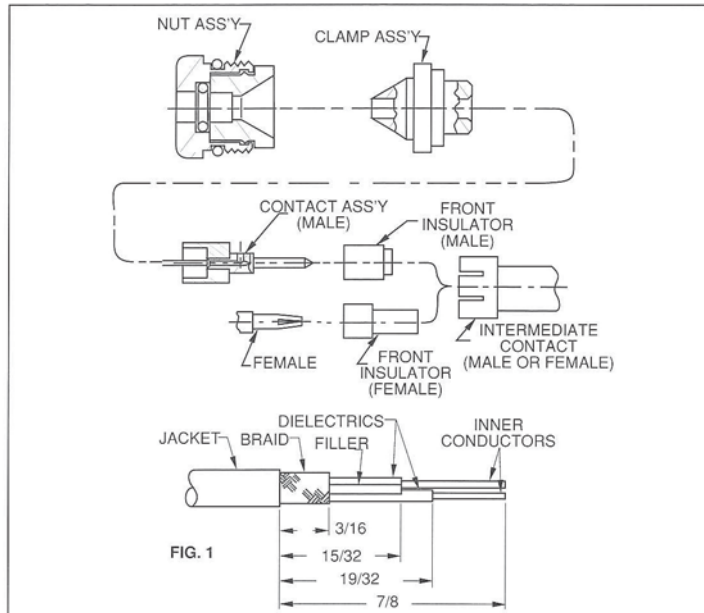
**2.** Point cable as shown. Recommended tooling KTO-3A (ROTO-STRIP) .085 S.R. or KTO-2A (ROTO-STRIP) .141 S.R.

**3.** Insert cable into connector making sure cable seats against internal shoulder of body.

**4.** Solder cable onto body as shown.

S/R CABLE	A	B
.086	.065	.070
	.075	
.141	.080	.085
	.090	

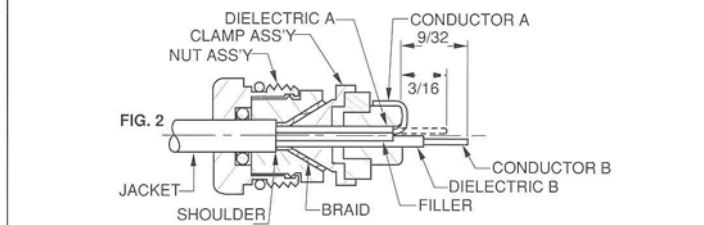




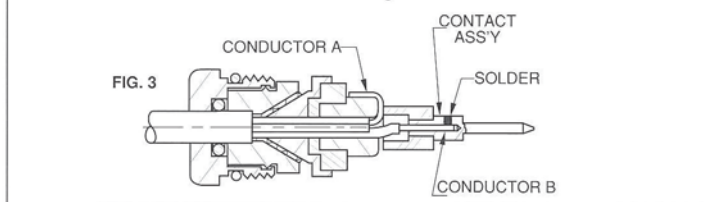
**1.** Cut cable end square. Trim cable as shown in Fig. 1 and secure braid with scotch "magic" tape.

**2.** Insert cable into nut ass'y butting jacket edge against internal shoulder. Remove tape and flare braid against nut ass'y internal taper. Slide clamp ass'y over dielectrics and fillers pressing firmly against flared braid as shown in Fig. 2.

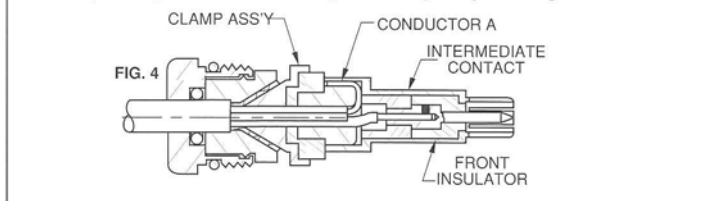
**3.** Trim inner conductor A to 3/16 and fold back over clamp ass'y (Fig. 2). Trim inner conductor B to 9/32 (Fig. 2).



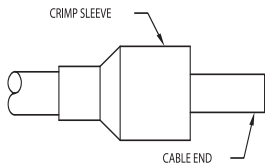
**4.** Place contact ass'y over dielectric and inner conductor B and solder contact to inner conductor B as shown in Fig. 3.



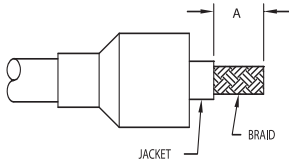
**5.** Place front insulator on center contact and assemble intermediate contact pressing inner conductor A against clamp ass'y as in Fig. 4



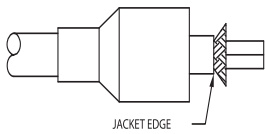
**6.** Insert parts into body ass'y and tighten clamp nut securely. Recommended torque 30-35 inch-pounds.



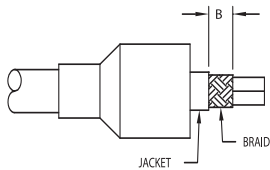
CUT CABLE END SQUARE AND SLIDE CRIMP SLEEVE OVER CABLE AS SHOWN.



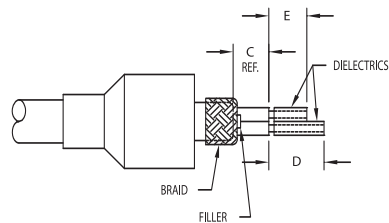
REMOVE JACKET TO "A" DIMENSION



FLARE OR BULGE BACK BRAID AND TRIM WITH SCISSORS AT EDGE OF JACKET

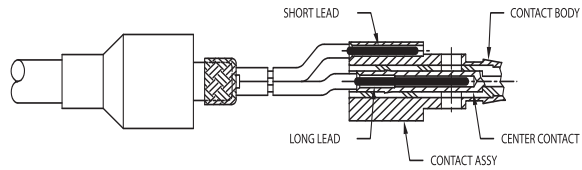


REMOVE JACKET TO "B" DIMENSION, TAKING CARE NOT TO NICK BRAID.

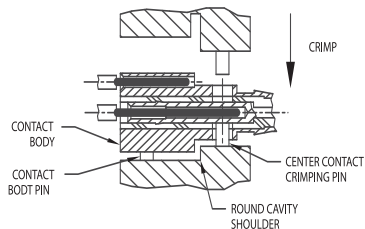


FOLD BACK BRAID AND TRIM BOTH FILLERS FLUSH WITH FOLD. THEN CUT THRU BOTH DIELECTRICS. AT "D" DIMENSION (DO NOT NICK CONDUCTORS AND DO NOT REMOVE DIELECTRICS). NEXT, TRIM ONE OF THE LEADS TO THE "E" DIMENSION, THE REMAINING LONG LEAD WILL BE INSERTED INTO THE CENTER CONTACT IN THE NEXT STEP.

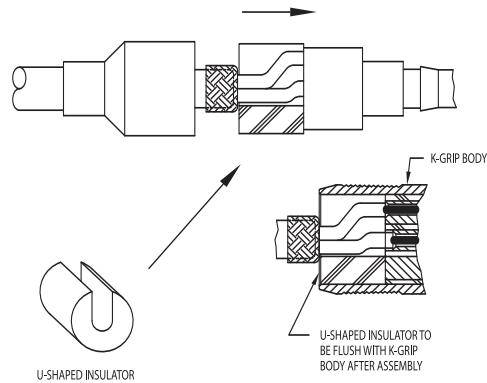
DASH NO	A	B	C	D	E	UNITS
-1	.350	.375	.410	.315	.172	IN.
	8.9	9.5	10.4	8.0	4.4	mm



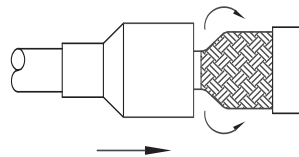
REMOVE THE DIELECTRICS AND INSERT CENTER CONDUCTORS (LONG LEAD IN CENTER, SHORT LEAD IN CONTACT BODY) INTO CONTACT ASSY. A GENTLE ROCKING MOTION OF THE CABLE WILL FACILITATE ENTRY OF THE LEADS.



PLACE APPROPRIATE CRIMP DIE INTO CRIMPING TOOL. INSERT CONTACT ASSEMBLY, WITH CABLE CONDUCTORS IN PLACE, AGAINST THE ROUND DIE CAVITY SHOULDER. LINE UP CENTER CONTACT CRIMPING PINS WITH CLEARANCE HOLES (MAKE SURE THAT THE CONDUCTOR INSERTED IN THE CONTACT BODY IS IN LINE WITH THE CONTACT BODY PIN). CRIMP CAREFULLY.

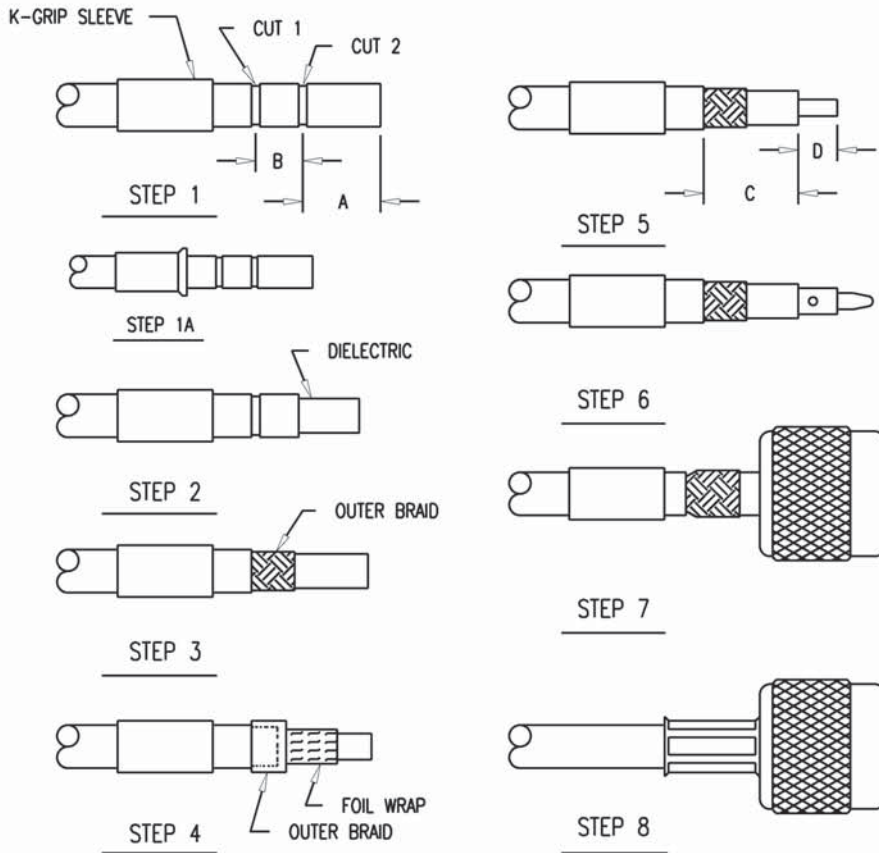


SLIDE U-SHAPED INSULATOR INTO GAP BETWEEN CONTACT ASSEMBLY AND BRAID. USING INSULATOR SNAP IN CONTACT ASSEMBLY INTO K-GRIP BODY.



FOLD BRAID BACK OVER K-GRIP BODY. SLIDE CRIMP SLEEVE OVER BRAID AND BODY. CRIMP WITH HEX CAVITY OF DIE.





**STEP 1.**  
CUT CABLE END SQUARE, SLIDE K-GRIP SLEEVE OVER JACKET. (CAUTION: WHEN USING A SINGLE STEP W/P SLEEVE, SLIDE SMALL END OVER CABLE FIRST AS SHOWN, SEE STEP 1A.) WITH JACKET TRIM JIG MAKE CUTS 1 AND 2 IN JACKET.

**STEP 2.**  
REMOVE JACKET TO DIMENSION "A". FLARE OR BULGE BACK OUTER BRAID, (FLAT STRIP BRAID AND FOIL WRAP WHEN APPLICABLE) AND TRIM AT EDGE OF JACKET.

**STEP 3.**  
REMOVE JACKET TO DIMENSION "B".

**STEP 4. (FOR CABLES WITH FOIL WRAP)**  
FOLD BACK OUTER BRAID (OR IN SOME CASES FLAT STRIP BRAID) AT JACKET SHOULDER AND REMOVE FOIL WRAP. BE SURE NOT TO DAMAGE EITHER BRAID WHEN REMOVING FOIL WRAP. FOLD DOWN BRAID BACK IN PLACE OVER DIELECTRIC TAKING CARE TO LEAVE STRANDS IN PLACE AS MUCH AS POSSIBLE.

**STEP 5.**  
USING DIELECTRIC TRIM JIG, TRIM DIMENSION "C". EXPOSED CENTER CONDUCTOR LENGTH WILL BE EQUAL TO DIMENSION "D" OF TRIM CODE

**STEP 6.**  
BOTTOM CONTACT AGAINST DIELECTRIC. SOLDER OR CRIMP CONTACT TO CENTER CONDUCTOR.

**STEP 7.**  
FLARE OUTER BRAID (AND FLAT STRIP BRAID) BY CAREFULLY ROTATING THE DIELECTRIC. PUSH K-GRIP JR. OVER DIELECTRIC AND UNDER BOTH BRAIDS UNTIL CONTACT SNAPS IN PLACE OR DIELECTRIC BOTTOMS IN CONNECTOR.

**STEP 8.**  
SLIDE K-GRIP SLEEVE AGAINST SHOULDER ON BODY AND FORM HEX BY CRIMPING.

TRIM CODE CHART

DASH NO.	A	B	C	D
-1	.250	.344	.432	.156
-2	.375	.313	.500	.188
-3	.313	.281	.432	.156
-4	.281	.406	.500	.187



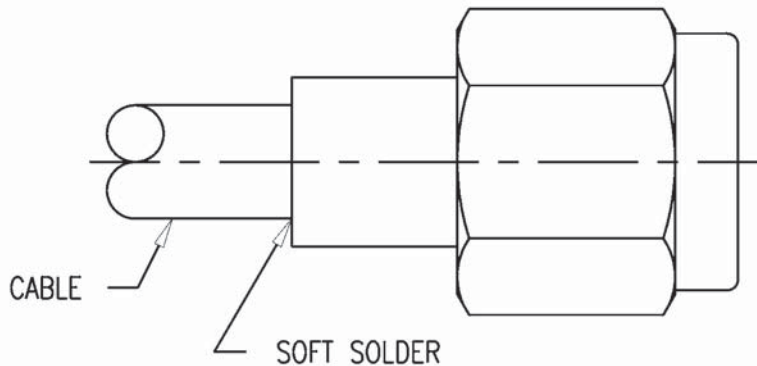
1. REMOVE CABLE OUTER CONDUCTOR AND DIELECTRIC TO .070 DIMENSION AS SHOWN.
2. CHAMFER CENTER CONDUCTOR TO 30° ANGLE AS SHOWN.



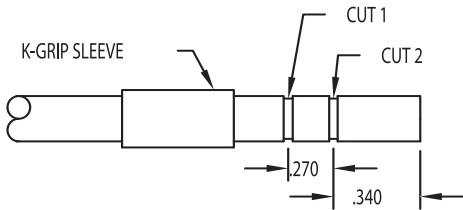
NOTE: STEP 1 & 2 MAY BE ACCOMPLISHED WITH EASE AND ACCURACY USING KINGS KTO-3 STRIPPING TOOL.

3. INSERT CABLE INTO BACK END OF CONNECTOR. PUSH CABLE IN FIRMLY UNTIL THE FACE OF CABLE BOTTOMS AGAINST REAR END OF INSULATOR. (CAUTION: EJECTION OF INSULATOR MAY BE PREVENTED BY MATING WITH A CONNECTOR OF OPPOSITE SEX).

INSERT CABLE IN POSITION SHOWN



4. SOLDER BACK END OF CONNECTOR.



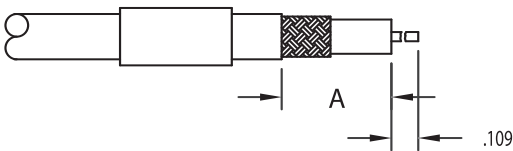
1. CUT CABLE END SQUARE, SLIDE K-GRIP SLEEVE OVER JACKET & WITH TRIM JIG MAKE CUTS 1 AND 2 IN JACKET.



2. REMOVE JACKET TO DIMENSION .340, FLARE OR BULGE BACK BRAID & TRIM WITH SCISSORS AT EDGE OF JACKET.



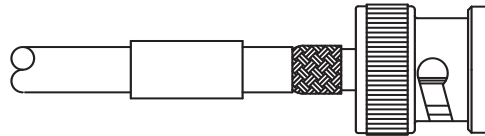
3. REMOVE JACKET TO DIMENSION .270.



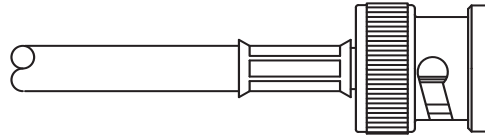
4. TRIM TO DIMENSION A. EXPOSED CENTER CONDUCTOR LENGTH WILL BE EQUAL TO .109 DIMENSION.

5. SOLDER CONTACT FOR THE STRAIGHT CONNECTOR ONLY, THEN PROCEED TO STEP 7.

6. CONTACT NOT USED FOR THE ANGLE CONNECTOR. PROCEED TO STEP 7, THEN SOLDER CABLE CENTER CONDUCTOR TO CONNECTOR CENTER CONTACT.

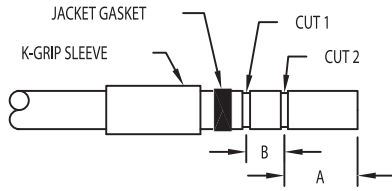


7. CAREFULLY INSERT CABLE INTO CONNECTOR. PUSH K-GRIP JR. OVER DIELECTRIC & UNDER BRAID.



8. SLIDE K-GRIP SLEEVE AGAINST SHOULDER ON BODY AND FORM BY CRIMPING.

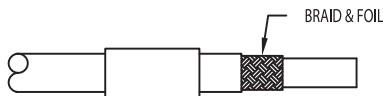
KINGS NO.	A
3-483-1	.390
3-483-2	.500



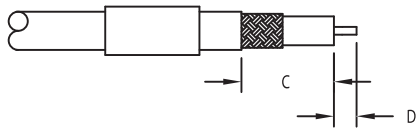
1. CUT CABLE END SQUARE, SLIDE K-GRIP SLEEVE AND GASKET OVER JACKET & WITH JACKET TRIM JIG MAKE CUTS 1 AND 2 IN JACKET.



2. REMOVE JACKET TO DIMENSION "A", FLARE OR BULGE BACK BRAID AND FOIL & TRIM WITH SCISSORS AT EDGE OF JACKET.

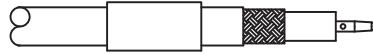


3. REMOVE JACKET TO DIMENSION "B".

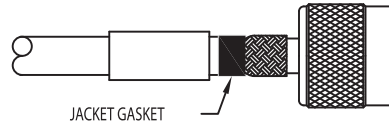


4. USING DIELECTRIC TRIM JIG, TRIM DIMENSION "C". EXPOSED CENTER CONDUCTOR LENGTH WILL BE EQUAL TO DIMENSION "D" OF TRIM CODE.

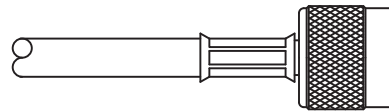
TRIM CODE CHART			
A	B	C	D
.250	.344	.432	.156



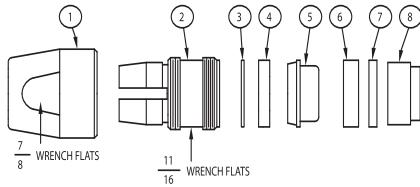
5. SOLDER OR CRIMP CONTACT TO CENTER CONDUCTOR.



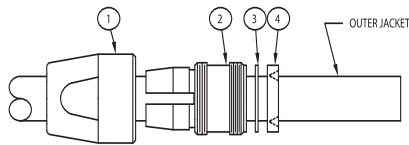
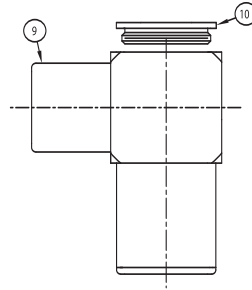
6. PUSH K-GRIP JR. OVER DIELECTRIC AND FOIL AND UNDER BRAID UNTIL DIELECTRIC BOTTOMS IN CONNECTOR. SLIDE JACKET GASKET FLUSH WITH JACKET EDGE.



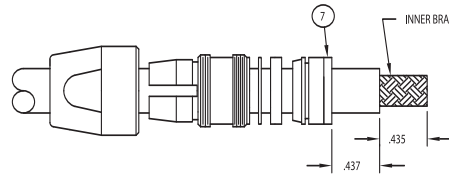
7. SLIDE K-GRIP SLEEVE OVER GASKET AND AGAINST SHOULDER ON BODY AND FORM HEX.



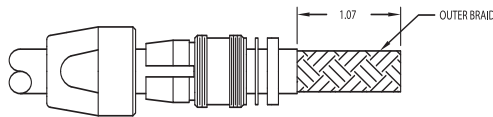
NOTE: CARE MUST BE TAKEN WHEN TRIMMING CABLE THAT THE BRAIDS, INSULATOR AND CONDUCTORS OF THE CABLE ARE NOT NICKED OR DAMAGED.



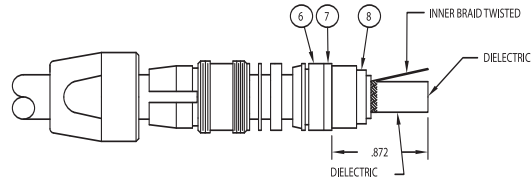
1. CUT CABLE END SQUARE. PLACE NUT, ITEM 1, COLLET, ITEM 2, THIN WASHER ITEM 3 AND VEE GASKET, ITEM 4 OVER THE JACKET.



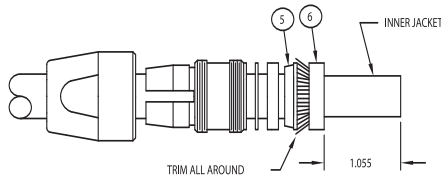
4. SLIDE THICK WASHER, ITEM 7 OVER INNER JACKET AND AGAINST OUTER GROUND RING. REMOVE INNER JACKET TO .437 DIMENSION. DO NOT NICK THE BRAID. LENGTH OF INNER BRAID TO BE .435.



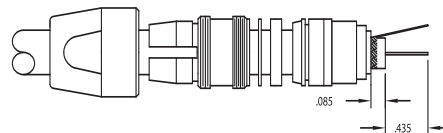
2. REMOVE OUTER JACKET TO 1.07 DIMENSION SHOWN.



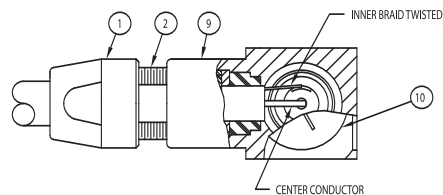
5. PLACE INSULATOR, ITEM 8 OVER THE INNER JACKET AND SEAT AGAINST THE THICK WASHER, ITEM 7 TO .872 DIMENSION. COMB OUT INNER BRAID AND TWIST WIRE STRANDS INTO ONE LEAD AS SHOWN. INNER BRAID MAY BE TRIMMED AS REQUIRED TO FACILITATE TWISTING.



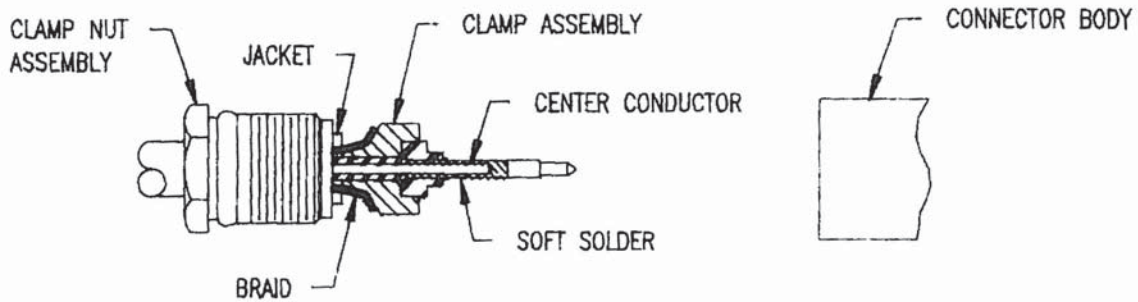
3. PLACE BRAID CLAMP, ITEM 5 OVER THE OUTER BRAID AND SEAT AGAINST THE OUTER JACKET. FOLD THE OUTER BRAID BACK OVER THE BRAID CLAMP, AND PRESS THE OUTER GROUND RING, ITEM 6 OVER THE BRAID CLAMP SO THAT THE OUTER GROUND RING IS FLUSH TO THE EDGE OF THE BRAID CLAMP. (1.055 DIMENSION) TRIM EXCESS BRAID THAT EXTENDS BEYOND THE OUTER DIAMETER OF THE BRAID CLAMP.



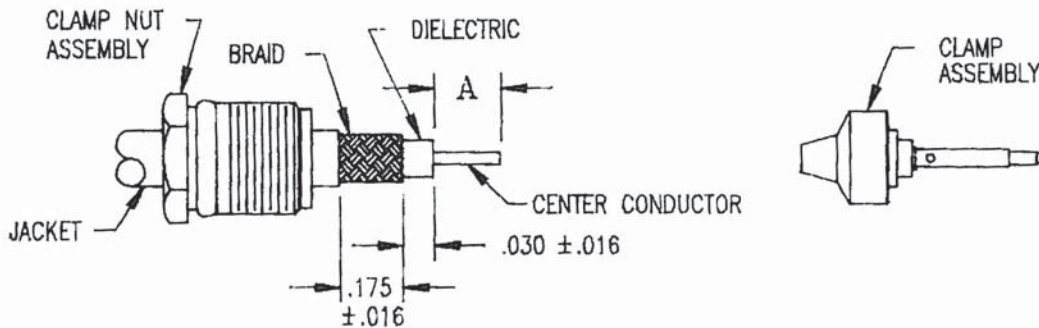
6. REMOVE DIELECTRIC TO .085 DIMENSION. EXPOSED CENTER CONDUCTOR TO BE .435 DIMENSION.



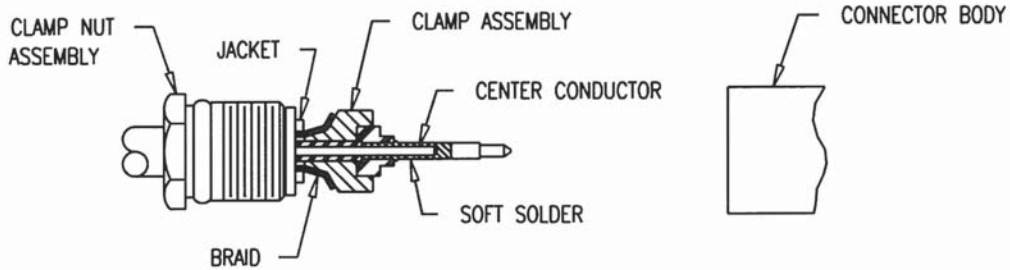
7. SLIDE CABLE ASSEMBLY INTO BODY, ITEM 9, AND ALIGN AS SHOWN, PLACING THE CENTER CONDUCTOR INTO THE SLOTTED CENTER CONTACT, AND THE TWISTED INNER BRAID TO BE PLACED ON THE INTERMEDIATE CONTACT TAB. TIGHTEN COLLET, ITEM 2, TO BODY WITH A MINIMUM OF 80 IN-LBS OF TORQUE. IT IS RECOMMENDED NOT TO EXCEED 125 INCH LBS. OF TORQUE. LOCK CLAMP NUT, ITEM 1, TO COLLECT TO PREVENT ROTATION OF CABLE JACKET WITHIN THE CONNECTOR. SOLDER THE TWISTED INNER BRAID TO THE INTERMEDIATE CONTACT TAB, THEN SOLDER THE CENTER CONDUCTOR TO THE CENTER CONTACT. THREAD SCREW CAP, ITEM 10, INTO BODY AND TIGHTEN SECURELY.



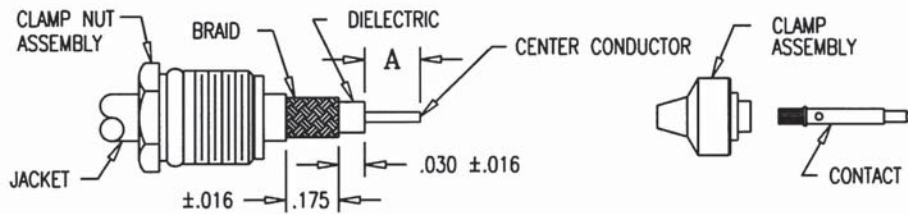
1. CUT CABLE END SQUARE. SLIDE CLAMP NUT OVER JACKET & TRIM CABLE TO DIM'S SHOWN.
2. INSERT CLAMP ASSEMBLY BETWEEN DIELECTRIC & BRAID UNTIL DIELECTRIC BOTTOMS IN ASSEMBLY AND CENTER CONDUCTOR IS VISIBLE THROUGH CONTACT SOLDER HOLE. SOLDER CENTER CONDUCTOR.
3. INSERT CABLE ASSEMBLY INTO CONNECTOR BODY, SLIDE CLAMP ASSEMBLY FORWARD UNTIL SEATED AND TIGHTEN CLAMP NUT TO A TORQUE OF 30 INCH/LBS. WHEN TIGHTENING THE CLAMP NUT ASSEMBLY MAKE SURE ONLY THE NUT TURNS, DO NOT ROTATE BODY, DAMAGE TO THE CENTER CONDUCTOR MIGHT OCCUR.



KINGS PART NO.	CABLE PART NO. M17/	A DIM $\pm .016$
872-40-101	152-00001	.220
876-63-3	95-RG-180	
871-57-3	152-00001	

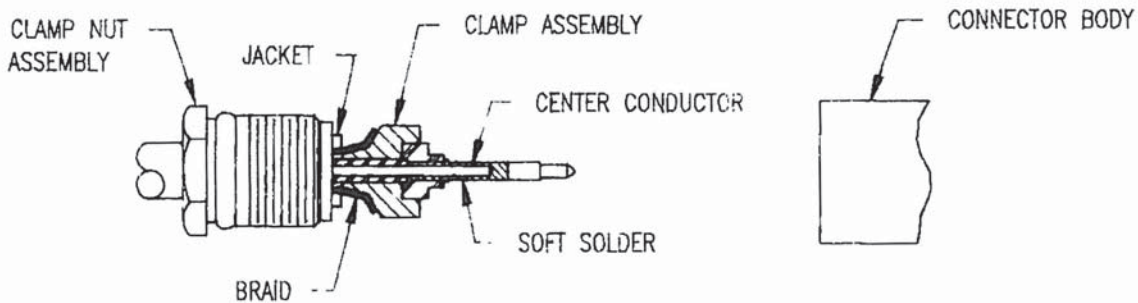


1. CUT CABLE END SQUARE. SLIDE CLAMP NUT OVER JACKET & TRIM CABLE TO DIM'S SHOWN.
2. INSERT CLAMP ASSEMBLY BETWEEN DIELECTRIC & BRAID UNTIL DIELECTRIC BOTTOMS IN ASSEMBLY AND CENTER CONDUCTOR IS VISIBLE. PRESS CONTACT INTO INSULATOR UNTIL BOTTOMED AND CENTER CONDUCTOR IS VISIBLE THROUGH CONTACT SOLDER HOLE. SOLDER CENTER CONDUCTOR.
3. INSERT CABLE ASSEMBLY INTO CONNECTOR BODY, SLIDE CLAMP ASSEMBLY FORWARD UNTIL SEATED AND TIGHTEN CLAMP NUT TO A TORQUE OF 30 INCH/LBS. WHEN TIGHTENING THE CLAMP NUT ASSEMBLY MAKE SURE ONLY THE NUT TURNS, DO NOT ROTATE BODY, DAMAGE TO THE CENTER CONDUCTOR MIGHT OCCUR.
4. WHEN USING M17/84-RG223 CABLE, A SMALL AMOUNT OF O-RING LUBE MAY BE USED TO FACILITATE CABLE JACKET ENTRY THROUGH THE INTERNAL O-RING. IF DESIRED, THE INTERNAL O-RING MAY BE DISCARDED WHEN USING THIS CABLE.

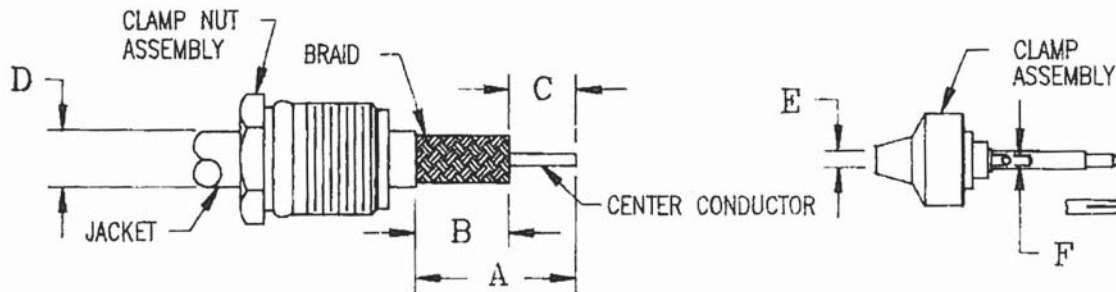


MILITARY PART NO. M39012/	KINGS PART NO.	CABLE PART NO. M17/	A DIM ±.016	
55-3009	875-82-17	28-RG058	.160	
55-3109	875-82-3	60-RG142		
56-3109	876-61-3	84-RG223		
56-3009	876-61-17	155-00001		
57-3009	873-48-3	158-00001		
58-3009	871-51-3	167-00001		
59-3009	872-45-3			
55-3010	875-85-17	111-RG303		.160
55-3110	875-85-3	170-00001		
56-3010	876-67-17			
56-3110	876-67-3			
57-3010	873-49-3			
58-3010	871-55-3			
59-3010	872-46-3			
55-3030	875-86-17	152-00001	.220	
55-3130	875-86-3			
56-3030	876-62-17			
56-3130	876-62-3			
57-3030	873-50-3			
58-3030	871-56-3			
59-3030	872-40-3			



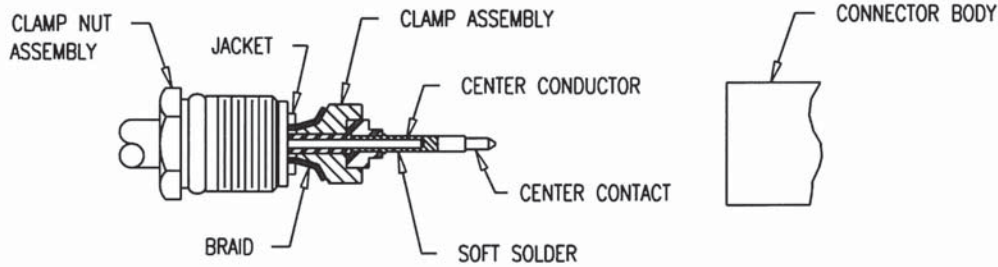


1. CUT CABLE END SQUARE. SLIDE CLAMP NUT OVER JACKET & TRIM CABLE TO DIM'S SHOWN.
2. INSERT CLAMP ASSEMBLY BETWEEN DIELECTRIC & BRAID UNTIL DIELECTRIC BOTTOMS IN ASSEMBLY AND CENTER CONDUCTOR IS VISIBLE THROUGH CONTACT SOLDER HOLE SOLDER CENTER CONDUCTOR.
3. INSERT CABLE ASSEMBLY INTO CONNECTOR BODY, SLIDE CLAMP ASSEMBLY FORWARD UNTIL SEATED AND TIGHTEN CLAMP NUT TO A TORQUE OF 30 INCH/LBS. WHEN TIGHTENING THE CLAMP NUT ASSEMBLY MAKE SURE ONLY THE NUT TURNS, DO NOT ROTATE BODY, DAMAGE TO THE CENTER CONDUCTOR MIGHT OCCUR.

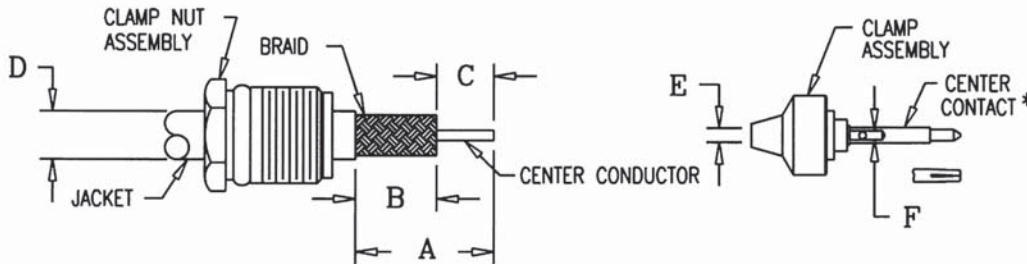


MILITARY PART NO. M39012/	KINGS PART NO.	CABLE PART NO. M17,	A DIM ±.016	B DIM ±.016	C DIM ±.016	D DIM	E DIM	F DIM
26-0101 27-0101 28-0101 29-0101 30-0101	125-67-5 123-12-5 122-27-5 121-23-5 126-55-5	J28-RG058 J84-RG223 128-RG400 060-RG142	.600	.380	.220	.220	.120	.050
26-0102 27-0102 28-0102 29-0102 30-0102	125-72-5 123-13-5 122-28-5 121-26-5 126-54-5	29-RG59 * 030-RG062 90-RG71 97-RG210	.660	.440	.220	.259	.150	.050
26-0103 27-0103 28-0103 29-0103 30-0103	125-73-5 123-14-5 122-29-5 121-27-5 126-56-5	054-RG122	.600	.380	.220	.180	.100	.050

\* FOR AIR SPACED CABLE USE INSULATOR BUSHING SUPPLIED  
 REDUCE "B" DIM (DIELECTRIC ONLY) BY .032 AND INCREASE "C" DIM TO .250



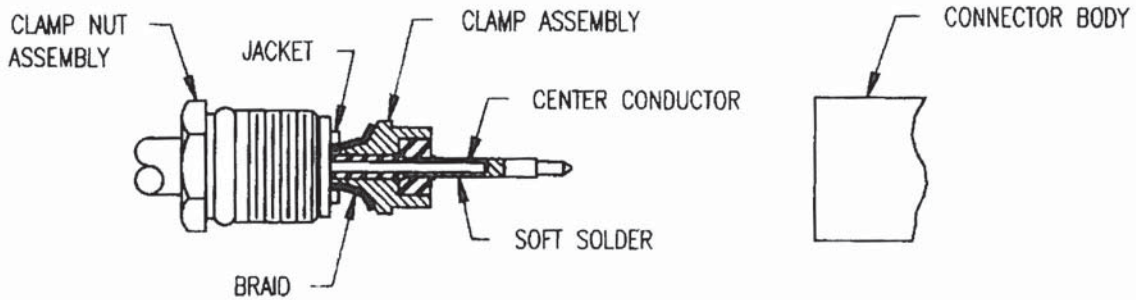
1. CUT CABLE END SQUARE. SLIDE CLAMP NUT OVER JACKET & TRIM CABLE TO DIM'S SHOWN.
2. INSERT CLAMP ASSEMBLY BETWEEN DIELECTRIC & BRAID UNTIL DIELECTRIC BOTTOMS IN ASSEMBLY AND CENTER CONDUCTOR IS VISIBLE THROUGH CONTACT SOLDER HOLE. SOLDER CENTER CONDUCTOR.  
WHEN CENTER CONTACT IS SUPPLIED LOOSE INSERT CLAMP ASSEMBLY BETWEEN DIELECTRIC AND BRAID UNTIL DIELECTRIC BOTTOMS IN ASSEMBLY AND CENTER CONDUCTOR IS VISIBLE. PRESS CENTER CONTACT INTO INSULATOR UNTIL BOTTOMED AND CENTER CONDUCTOR IS VISIBLE THROUGH SOLDER HOLE. SOLDER CENTER CONDUCTOR.
3. INSERT CABLE ASSEMBLY INTO CONNECTOR BODY, SLIDE CLAMP ASSEMBLY FORWARD UNTIL SEATED AND TIGHTEN CLAMP NUT TO A TORQUE OF 30 INCH/LBS. WHEN TIGHTENING THE CLAMP NUT ASSEMBLY MAKE SURE ONLY THE NUT TURNS, DO NOT ROTATE BODY, DAMAGE TO THE CENTER CONDUCTOR MIGHT OCCUR.



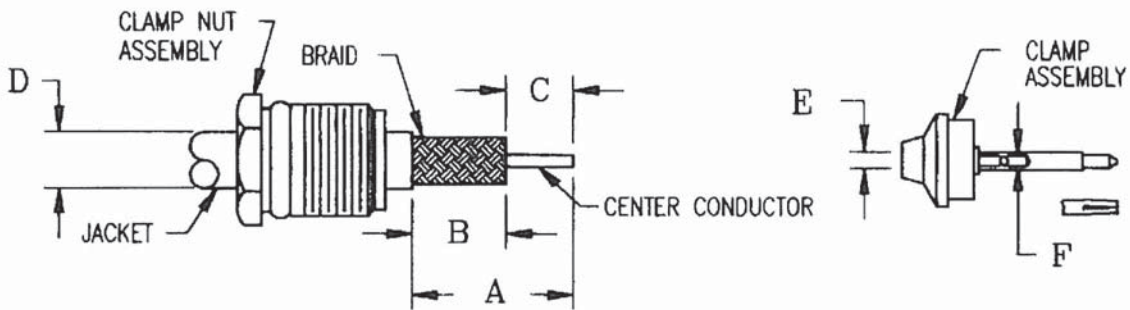
MILITARY PART NO. M39012/	KINGS PART NO.	CABLE PART NO. M17/	A DIM ±.016	B DIM ±.016	C DIM ±.016	D DIM	E DIM	F DIM
26-0104 27-0104 28-0104 29-0104 30-0104	125-74-5 123-15-5 122-30-5 121-28-5 126-61-5	111-RG303	.600	.380	.220	.180	.120	.050
26-0117 27-0117 28-0117 29-0117 30-0117	125-75-5 123-16-5 122-31-5 121-29-5 126-62-5	110-RG302	.660	.440	.220	.220	.150	.050
26-0018 27-0018 28-0018 29-0018 30-0118	125-76-5 123-17-5 122-32-5 121-30-5 126-56-5	113-RG316 119-RG174	.545	.220	.325	.127	.065	.025

\* CENTER CONTACT SUPPLIED LOOSE WITH RG316/RG174 CONNECTORS

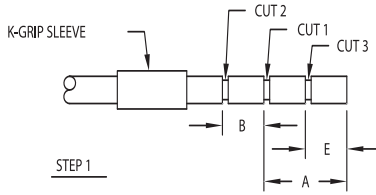




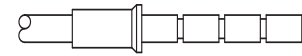
1. CUT CABLE END SQUARE. SLIDE CLAMP NUT OVER JACKET & TRIM CABLE TO DIM'S SHOWN.
2. INSERT CLAMP ASSEMBLY BETWEEN DIELECTRIC & BRAID UNTIL DIELECTRIC BOTTOMS IN ASSEMBLY AND CENTER CONDUCTOR IS VISIBLE THROUGH CONTACT SOLDER HOLE SOLDER CENTER CONDUCTOR.
3. INSERT CABLE ASSEMBLY INTO CONNECTOR BODY, SLIDE CLAMP ASSEMBLY FORWARD UNTIL SEATED AND TIGHTEN CLAMP NUT TO A TORQUE OF 65 INCH/LBS. WHEN TIGHTENING THE CLAMP NUT ASSEMBLY MAKE SURE ONLY THE NUT TURNS, DO NOT ROTATE BODY, DAMAGE TO THE CENTER CONDUCTOR MIGHT OCCUR.



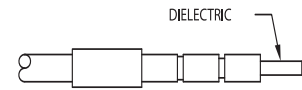
MILITARY PART NO. M39012/	KINGS PART NO.	CABLE PART NO. M17/	A DIM ±.016	B DIM ±.016	C DIM ±.016	D DIM	E DIM	F' DIM
1-0005	1205-35-5	6-RG11						
2-0003	1203-10-5	62-RG144						
2-0006	1201-9-5	65-RG165						
3-0012	1202-9-5	74-RG213	.750	.468	.281	.44	.295	.098
5-0101	1206-23-5	75-RG214 77-RG216 86-00001						
1-0015	1205-37-5	RG-217	.718	.500	.218	.57	.38	.113



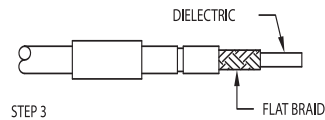
STEP 1



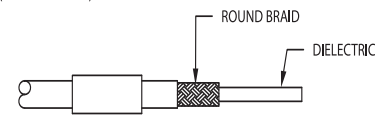
STEP 1A



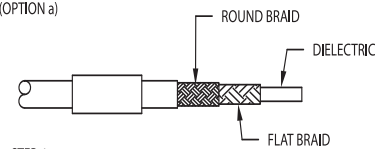
STEP 2



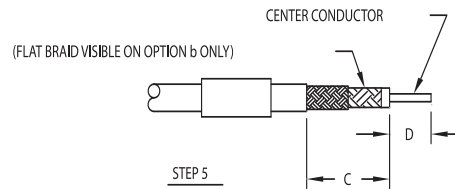
STEP 3  
(OPTION b ONLY)



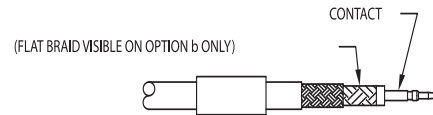
STEP 4  
(OPTION a)



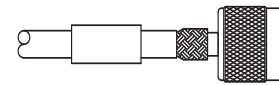
STEP 4  
(OPTION b)



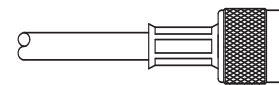
STEP 5



STEP 6



STEP 7

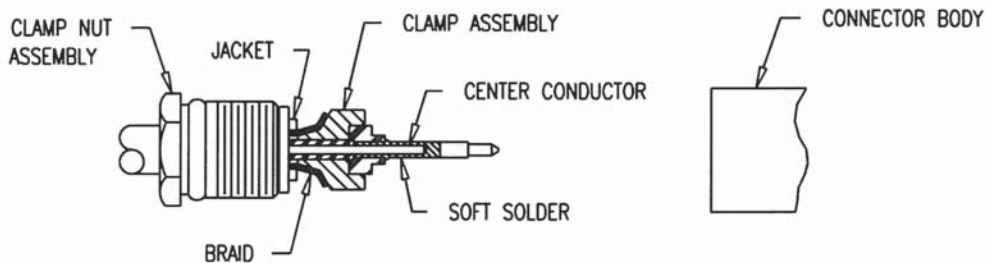


STEP 8

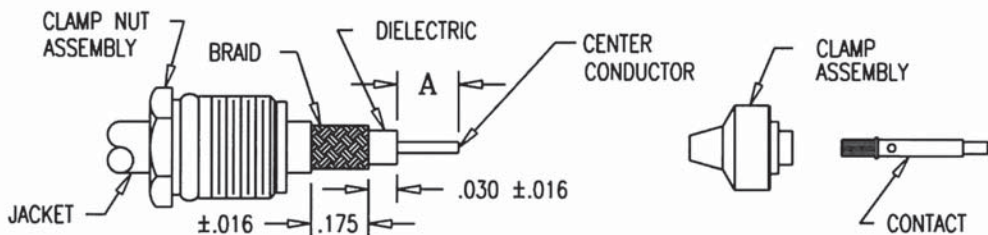
- STEP 1 (OPTION a & b):**  
CUT CABLE END SQUARE, SLIDE K-GRIP SLEEVE (SHRINK TUBING OPTIONAL) OVER JACKET. (CAUTION: WHEN USING A SINGLE STEP W/P SLEEVE, SLIDE SMALL END OVER CABLE FIRST AS SHOWN, SEE STEP 1A) MAKE CUTS 1 AND 2 IN JACKET. (OPTION b ONLY): MAKE ADDITIONAL CUT 3 IN JACKET.
- STEP 2 (OPTION a & b):**  
REMOVE JACKET TO DIMENSION "A" (OPTION a) OR "E" (OPTION b). REMOVE ROUND BRAID AND FLAT BRAID AT EDGE OF JACKET. BE SURE ENDS OF FLAT BRAID ARE FLAT AGAINST DIELECTRIC. (IF USING OPTION a PROCEED TO STEP 4).
- STEP 3 (OPTION b ONLY):**  
REMOVE JACKET TO DIMENSION "A". FLAIR OR BULGE BACK ROUND BRAID ONLY AND TRIM AT EDGE OF JACKET.
- STEP 4 (OPTION a & b):**  
REMOVE JACKET TO DIMENSION "B". FLAT BRAID IS VISIBLE ON OPTION b ONLY.
- STEP 5 (OPTION a & b):**  
TRIM DIELECTRIC TO DIMENSION "C". EXPOSED CENTER CONDUCTOR LENGTH WILL BE EQUAL TO DIMENSION "D".
- STEP 6 (OPTION a & b):**  
PLACE CONTACT ON CENTER CONDUCTOR AND BOTTOM AGAINST DIELECTRIC. SOLDER OR CRIMP CONTACT IN PLACE.
- STEP 7 (OPTION a & b):**  
PUSH THE K-GRIP BODY OVER THE DIELECTRIC AND FLAT BRAID AND UNDER ROUND BRAID UNTIL CONTACT SNAPS IN PLACE. (ONCE THE FLAT BRAID IS UNDER THE K-GRIP BODY, A CAREFUL ROTATION OF THE DIELECTRIC AND FLAT BRAID WILL EASE ASSEMBLY UNDER THE ROUND BRAID).
- STEP 8 (OPTION a & b):**  
SLIDE K-GRIP SLEEVE AGAINST SHOULDER ON BODY AND FORM HEX BY CRIMPING. (HEAT SHRINK TUBING AS REQUIRED)

TRIM CODE CHART

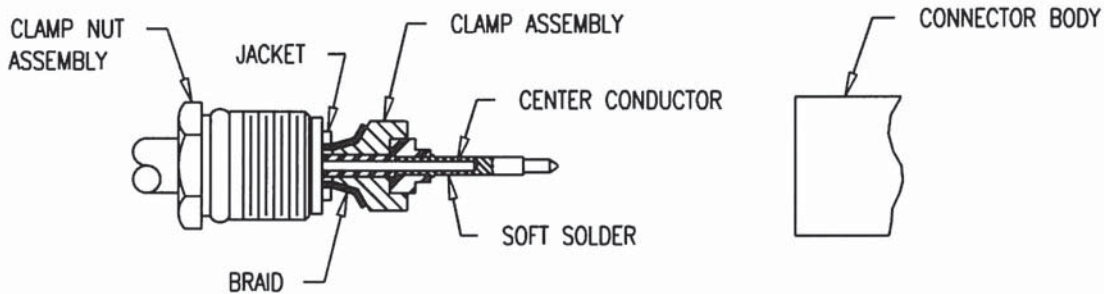
DASH NO.	OPTION	A	B	C	D	E
-1	a	.275	.312	.432	.156	_____
	b					.210
-2	a	.375		.500	.188	_____
	b					.260
-3	a	.293		.512	.094	_____
	b					.166
-4	a	.625		.750	.188	_____
	b					.260
-5	a	.218		.250	.398	.093
	b		.140			
-6	a	.250	.343	.437	.156	_____
	b					.210
-7	a	.552	.270	.634	.188	_____
	b					.260
-8	a	.275	.281	.400	.156	_____
	b					.210
-9	a	.563	.312	.687	.188	_____
	b					.260



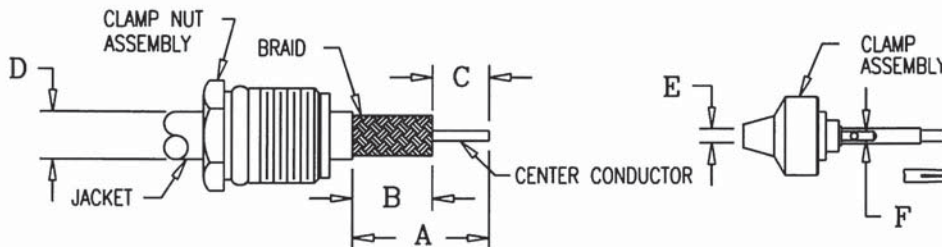
1. CUT CABLE END SQUARE. SLIDE CLAMP NUT OVER JACKET & TRIM CABLE TO DIM'S SHOWN.
2. INSERT CLAMP ASSEMBLY BETWEEN DIELECTRIC & BRAID UNTIL DIELECTRIC BOTTOMS IN ASSEMBLY AND CENTER CONDUCTOR IS VISIBLE. PRESS CONTACT INTO INSULATOR UNTIL BOTTOMED AND CENTER CONDUCTOR IS VISIBLE THROUGH CONTACT SOLDER HOLE. SOLDER CENTER CONDUCTOR.
3. INSERT CABLE ASSEMBLY INTO CONNECTOR BODY, SLIDE CLAMP ASSEMBLY FORWARD UNTIL SEATED AND TIGHTEN CLAMP NUT TO A TORQUE OF 30 INCH/LBS. WHEN TIGHTENING THE CLAMP NUT ASSEMBLY MAKE SURE ONLY THE NUT TURNS, DO NOT ROTATE BODY, DAMAGE TO THE CENTER CONDUCTOR MIGHT OCCUR.



MILITARY PART NO. M39012/	KINGS PART NO.	CABLE PART NO. M17/	A DIM ±.016
55-3006	875-83-17	93-RG178	.220
55-3106	875-83-3	169-00001	
56-3006	876-65-17		
56-3106	876-65-3		
57-3006	873-45-3		
58-3006	871-53-3		
59-3006	872-42-3		
55-3007	875-81-17	119-RG174	.220
55-3107	875-81-3	173-00001	
56-3007	876-60-17	113-RG316	
56-3107	876-60-3	172-00001	
57-3007	873-46-3		
58-3007	871-52-3		
59-3007	872-43-3		
55-3008	875-84-17	54-RG122	.220
55-3108	875-84-3	157-00001	
56-3008	876-66-17		
56-3108	876-66-3		
57-3008	873-47-3		
58-3008	871-54-3		
59-3008	872-44-3		



1. CUT CABLE END SQUARE. SLIDE CLAMP NUT OVER JACKET & TRIM CABLE TO DIM'S SHOWN.
2. INSERT CLAMP ASSEMBLY BETWEEN DIELECTRIC & BRAID UNTIL DIELECTRIC BOTTOMS IN ASSEMBLY AND CENTER CONDUCTOR IS VISIBLE THROUGH CONTACT SOLDER HOLE SOLDER CENTER CONDUCTOR.
3. INSERT CABLE ASSEMBLY INTO CONNECTOR BODY, SLIDE CLAMP ASSEMBLY FORWARD UNTIL SEATED AND TIGHTEN CLAMP NUT TO A TORQUE OF 30 INCH/LBS. WHEN TIGHTENING THE CLAMP NUT ASSEMBLY MAKE SURE ONLY THE NUT TURNS, DO NOT ROTATE BODY, DAMAGE TO THE CENTER CONDUCTOR MIGHT OCCUR.



MILITARY PART NO. M39012/	KINGS PART NO.	CABLE PART NO. M17/	A DIM ±.016	B DIM ±.016	C DIM ±.016	D DIM	E DIM	F DIM
16-0101 17-0101 18-0102 19-0101 20-0101	755-74-5 753-8-5 751-14-5 752-28-5 756-9-5	028-RG058 084-RG223 128-RG400 060-RG142	.563	.343	.220	.220	.120	.050
16-0102 17-0102 18-0101 19-0102 20-0102	755-77-5 753-9-5 751-13-5 752-29-5 756-12-5	29-RG59 * 030-RG062 90-RG71 97-RG210	.625	.406	.220	.259	.150	.050
16-0103 17-0103 18-0103 19-0110	755-83-5 753-10-5 751-15-5 752-31-5	054-RG122	.563	.343	.220	.180	.100	.050

\* FOR AIR SPACED CABLE USE INSULATOR BUSHING SUPPLIED  
REDUCE "B" DIM (DIELECTRIC ONLY) BY .032 AND INCREASE "C" DIM TO .250



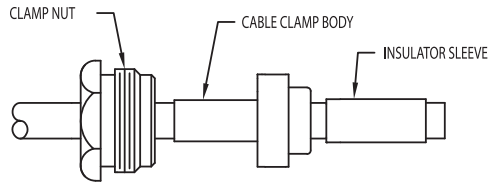
MILITARY PART NO. M39012/	KINGS PART NO.	CABLE PART NO. M17/	A DIM ±.016	B DIM ±.016	C DIM ±.016	D DIM	E DIM	F DIM
16-0111 17-0111 18-0111 19-0111	755-84-5 753-11-5 751-16-5 752-32-5	111-RG303	.563	.343	.220	.180	.120	.050
16-0118 17-0118 18-0118 19-0118 20-0108	755-85-5 753-12-5 751-17-5 752-33-5 756-13-5	110-RG-302	.625	.406	.220	.220	.150	.050
16-0220 17-0220 18-0220 19-0220	755-86-5 753-13-5 751-18-5 752-34-5	113-RG316 119-RG174	.545	.220	.325	.127	.065	.025

**1.** Cut cable end square. Slide clamp nut over jacket and trim cable to dimensions shown.

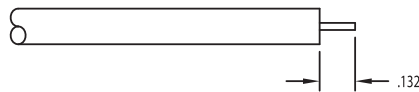
**2.** Insert clamp assembly between dielectric and braid until dielectric bottoms in assembly and center conductor is visible through contact solder hole solder center conductor.

When center contact is supplied loose insert clamp assembly between dielectric and braid until dielectric bottoms in assembly and center conductor is visible. Press center contact into insulator until bottomed and center conductor is visible through solder hole. Solder center conductor.

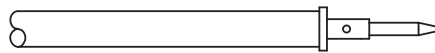
**3.** Insert cable assembly into connector body, slide clamp assembly forward until seated and tighten clamp nut to a torque of 30 inch/lbs. When tightening the clamp nut assembly make sure only the nut turns, do not rotate body, damage to the center conductor might occur.



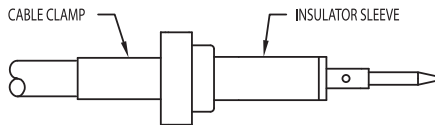
1. CUT CABLE END SQUARE AND SLIDE CLAMP NUT, CABLE CLAMP BODY AND INSULATOR SLEEVE ONTO CABLE.



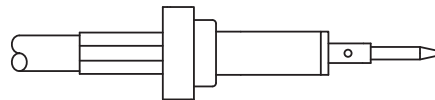
2. REMOVE JACKET TO DIMENSION SHOWN.



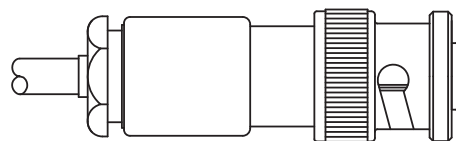
3. SOLDER OR CRIMP CONTACT TO CENTER CONDUCTOR.



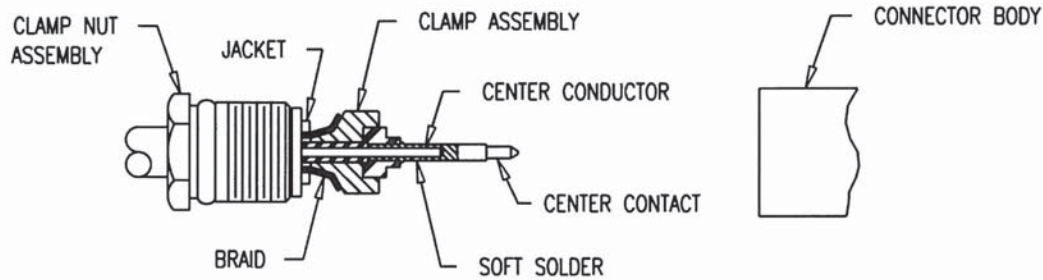
4. PUSH THE INSULATOR SLEEVE AGAINST THE CENTER CONTACT UNTIL BOTTOMED, THEN PUSH CABLE CLAMP BODY UNTIL BOTTOMED AGAINST INSULATOR SLEEVE, WHILE HOLDING THE CABLE CLAMP BODY AND THE INSULATOR SLEEVE AGAINST THE CONTACT, CRIMP THE CABLE CLAMP BODY IN PLACE AND FORM HEX.



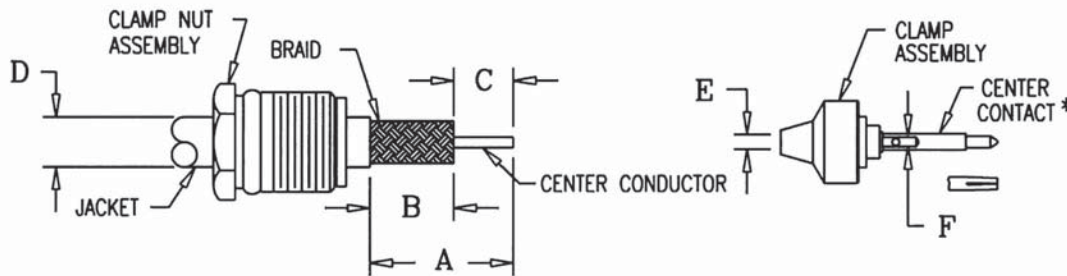
5. FINISHED CRIMP ASSY.



6. PUSH THE CRIMP ASSEMBLY INTO THE BODY UNTIL BOTTOMED, WRENCH TIGHTEN CLAMP NUT INTO CONNECTOR BODY. RECOMMENDED TORQUE 30-35 INCH-POUNDS.

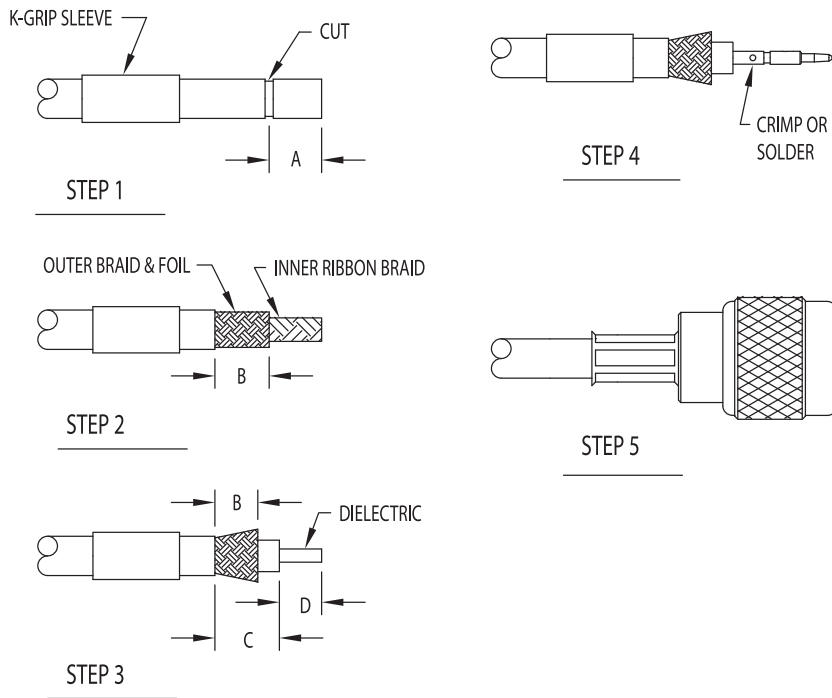


1. CUT CABLE END SQUARE. SLIDE CLAMP NUT OVER JACKET & TRIM CABLE TO DIM'S SHOWN.
2. INSERT CLAMP ASSEMBLY BETWEEN DIELECTRIC AND BRAID UNTIL DIELECTRIC BOTTOMS IN ASSEMBLY AND CENTER CONDUCTOR IS VISIBLE. PRESS CENTER CONTACT INTO INSULATOR UNTIL BOTTOMED AND CENTER CONDUCTOR IS VISIBLE THROUGH SOLDER HOLE. SOLDER CENTER CONDUCTOR.
3. INSERT CABLE ASSEMBLY INTO CONNECTOR BODY, SLIDE CLAMP ASSEMBLY FORWARD UNTIL SEATED AND TIGHTEN CLAMP NUT TO A TORQUE OF 30 INCH-LBS. WHEN TIGHTENING THE CLAMP NUT ASSEMBLY MAKE SURE ONLY THE NUT TURNS, DO NOT ROTATE BODY, DAMAGE TO THE CENTER CONDUCTOR MIGHT OCCUR.



KINGS PART NO.	CABLE PART NO. M17/	A DIM ±.016	B DIM ±.016	C DIM ±.016	D DIM	E DIM	F DIM
752-38-5	152-00001 (RD-316)	.532	.219	.313			
1202-16-5	113-RG316 119-RG174	.530	.210	.320	.127	.065	.033
1202-17-5	RAYTHEON 48152-1 152-00001 (RD-316)						

NOTES:  
 \* 1. CENTER CONTACT SUPPLIED LOOSE



STEP 1.  
CUT CABLE END SQUARE, SLIDE K-GRIP SLEEVE OVER JACKET AND MAKE CUT IN JACKET AT DIMENSION A.

STEP 2.  
REMOVE JACKET TO DIMENSION "A".  
TRIM OUTER WOVEN BRAID LAYER TO DIMENSION "B".  
CAREFULLY FOLD BACK THE REMAINING OUTER WOVEN BRAID LAYER JUST ENOUGH TO CUT AWAY THE THIN FOIL WRAP BETWEEN THE TWO BRAIDS. FOLD THE OUTER BRAID BACK IN POSITION.

STEP 3.  
FLARE RIBBON BRAID SLIGHTLY WITH FINGERS TO EDGE OF OUTER BRAID AND FOIL LAYERS. RIBBON SHOULD NOT BE TANGLED OR SHARPLY BENT. TRIM INNER RIBBON BRAID TO "B" DIMENSION SAME AS OUTER BRAID. TRIM DIELECTRIC TO "C" DIMENSION. TRIM CENTER CONDUCTOR TO "D" DIMENSION.

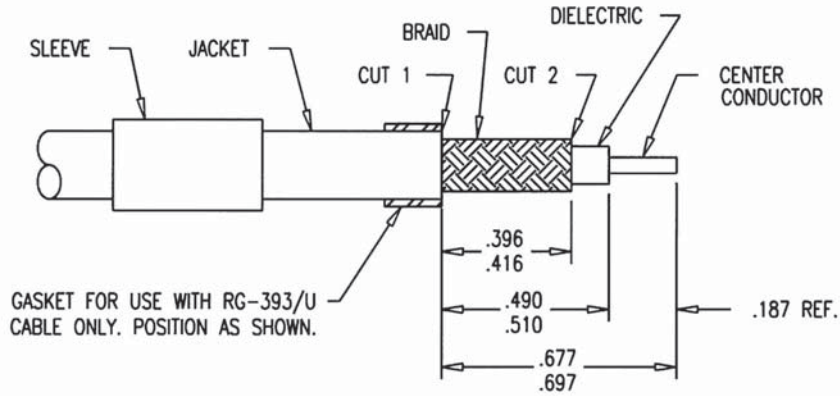
STEP 4.  
PLACE CENTER CONTACT ON CENTER CONDUCTOR, BUTT UP AGAINST DIELECTRIC AND CRIMP OR SOLDER IN PLACE.

STEP 5.  
ASSEMBLY K-GRIP END OF CONNECTOR BODY ASSEMBLY OVER DIELECTRIC AND UNDER FLARED BRAIDS, PUSHING CONTACT FIRMLY FORWARD UNTIL CONTACT GROOVE SNAPS INTO INTERNAL SHOULDER OF INSULATOR. SLIDE K-GRIP SLEEVE FORWARD OVER BOTH BRAID AGAINST BODY SHOULDER AND CRIMP HEX. USING KINGS CRIMP TOOL KTH-1000 AND DIE SHOWN IN CHART BELOW.

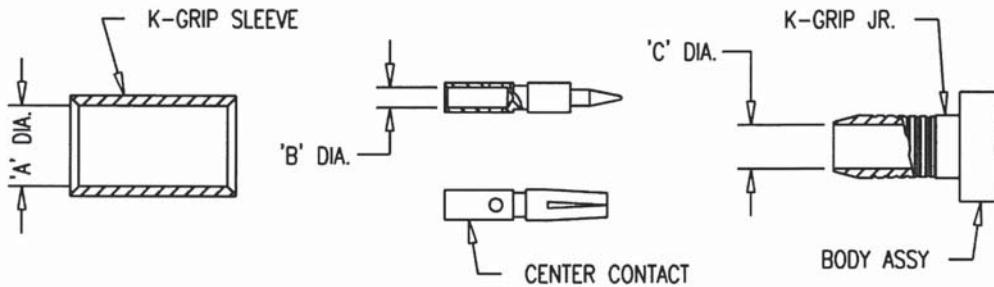
TRIM CODE CHART

CONNECTOR	A	B	C	D	DIE SIZE
1205-65-5	5/8	9/32	.425	3/16	KTH-2005
1206-31-5					
1202-25-5					
821-8-5					
825-15-5					
846-6-5	13/16	9/32	.611	3/16	KTH-2005
845-8-5					

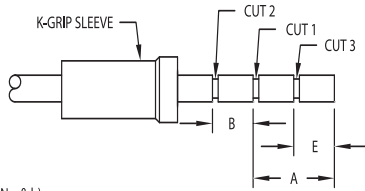




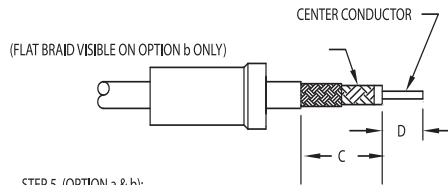
1. CUT CABLE END SQUARE. SLIDE K-GRIP SLEEVE OVER JACKET & MAKE CUTS 1 & 2 THROUGH JACKET ONLY.
2. REMOVE END OF JACKET UP TO CUT 2, FLARE OR BULGE BACK BRAID & TRIM WITH SCISSORS AT EDGE OF JACKET.
3. REMOVE JACKET BETWEEN CUTS 1 & 2 EXPOSING  $.406 \pm .010$  LENGTH OF BRAID.
4. TRIM DIELECTRIC TO  $.500 \pm .010$  DIM., EXPOSED CENTER CONDUCTOR WILL BE  $.187$  REF.
5. PLACE CENTER CONTACT ON CABLE AGAINST DIELECTRIC & CRIMP OR SOLDER IN PLACE.
6. PUSH K-GRIP JR. OVER DIELECTRIC AND UNDER BRAID UNTIL DIELECTRIC BOTTOMS IN CONNECTOR.
7. SLIDE K-GRIP SLEEVE OVER K-GRIP & BRAID TO SHOULDER OF BODY ASSY & FORM HEX USING APPLICABLE CRIMP TOOL & DIE.



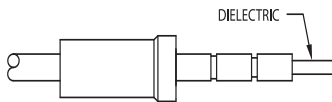
MILITARY PART NO.	KINGS PART NO.	PIECE PART DIM'S			SLEEVE (CRIMP TOOL M22520/5-01 DIE SIZE M22520/5-25)	EQUIV. KINGS DIE SIZE *
		A	B	C		
M39012/01-0017	1205-68-5	.420	.092	.297	CLOSURE A	KTH-2004
M39012/01-0018	1205-69-5	.440				



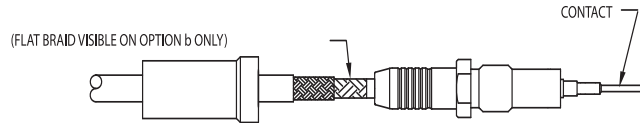
**STEP 1 (OPTION a & b):**  
CUT CABLE END SQUARE, SLIDE K-GRIP SLEEVE OVER JACKET.  
(CAUTION: WHEN USING A SINGLE STEP W/P SLEEVE, SLIDE SMALL END OVER CABLE FIRST AS SHOWN. MAKE CUTS 1 AND 2 IN JACKET. (OPTION b ONLY); MAKE ADDITIONAL CUT 3 IN JACKET.



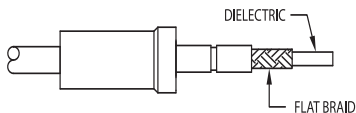
**STEP 5 (OPTION a & b):**  
TRIM DIELECTRIC TO DIMENSION "C". EXPOSED CENTER CONDUCTOR LENGTH WILL BE EQUAL TO DIMENSION "D".



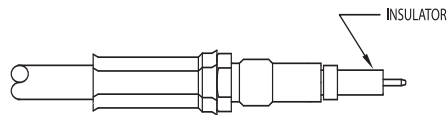
**STEP 2 (OPTION a & b):**  
REMOVE JACKET TO DIMENSION "A" (OPTION a) OR "E" (OPTION b). REMOVE ROUND BRAID AND FLAT BRAID AT EDGE OF JACKET. BE SURE ENDS OF FLAT BRAID ARE FLAT AGAINST DIELECTRIC. (IF USING OPTION a PROCEED TO STEP 4).



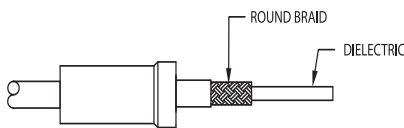
**STEP 6 (OPTION a & b):**  
PUSH THE K-GRIP BODY OVER THE DIELECTRIC AND FLAT BRAID AND UNDER THE ROUND BRAID (ONCE THE FLAT BRAID IS UNDER THE K-GRIP BODY, A CAREFUL ROTATION OF THE DIELECTRIC AND FLAT BRAID WILL EASE ASSEMBLY UNDER THE ROUND BRAID). THE CABLE CENTER CONDUCTOR WILL BE VISIBLE THROUGH THE CONTACT INSPECTION HOLES. CRIMP OR SOLDER THE CONTACT.



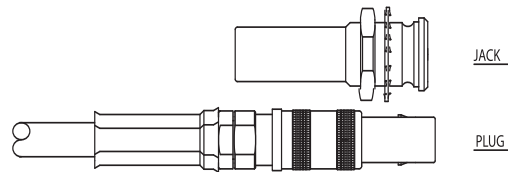
**STEP 3 (OPTION b ONLY):**  
REMOVE JACKET TO DIMENSION "A". FLAIR OR BULGE BACK ROUND BRAID ONLY AND TRIM AT EDGE OF JACKET.



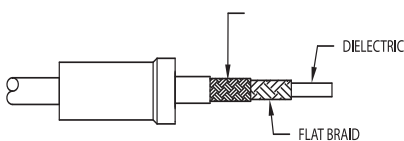
**STEP 7**  
SLIDE K-GRIP SLEEVE AGAINST SHOULDER ON BODY AND FORM HEX BY CRIMPING. INSTALL THE INSULATOR.



**STEP 4 (OPTION a):**  
REMOVE JACKET TO DIMENSION "B". FLAT BRAID IS VISIBLE ON OPTION b ONLY.



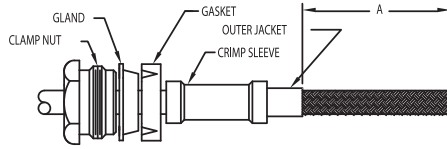
**STEP 8**  
SCREW THE OUTER BODY ONTO THE CRIMPED ASSEMBLY USING A MINIMUM TORQUE OF 5 INCH POUNDS AND A MAXIMUM TORQUE OF 10 INCH POUNDS.



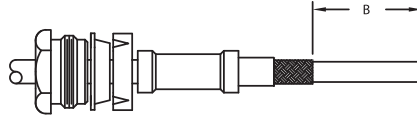
**STEP 4 (OPTION b):**  
REMOVE JACKET TO DIMENSION "B". FLAT BRAID IS VISIBLE ON OPTION b ONLY.

TRIM CODE CHART

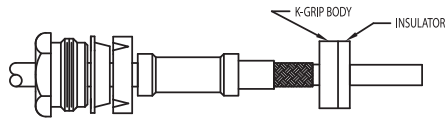
DASH NO.	OPTION	A	B	C	D	E
-1	a	.625	.312	.750	.188	—
	b					.260



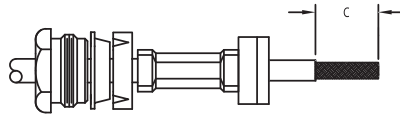
1. CUT CABLE END SQUARE. SLIDE CLAMP NUT, GLAND, GASKET, AND CRIMP SLEEVE OVER THE OUTER JACKET. REMOVE THE OUTER JACKET TO DIMENSION "A".



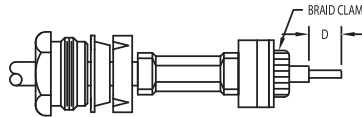
2. REMOVE THE OUTER BRAID TO DIMENSION "B"



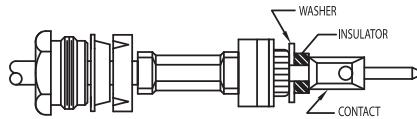
3. INSERT THE CABLE INTO THE K-GRIP BODY WITH THE BRAID OVER THE K-GRIP. SLIDE THE CRIMP SLEEVE OVER THE BRAID AND FORM A HEX WITH THE CRIMP DIE.



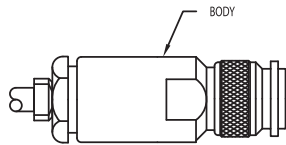
4 REMOVE THE INNER JACKET TO DIMENSION "C".



5. PLACE THE BRAID CLAMP OVER THE INNER BRAID AND AGAINST THE INNER JACKET. COMB OUT THE BRAID AND FOLD BACK OVER THE BRAID CLAMP. TRIM EVEN WITH THE BASE OF THE BRAID CLAMP. REMOVE DIELECTRIC TO DIMENSION "D".

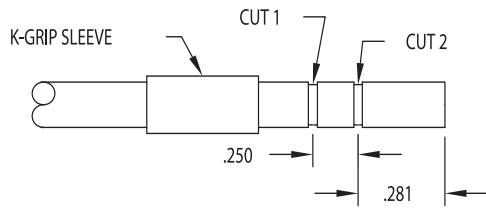


6. INSTALL THE WASHER AND INSULATOR OVER THE DIELECTRIC AND CRIMP THE CENTER CONTACT TO CENTER CONDUCTOR.

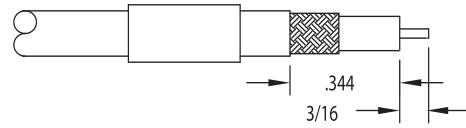


7. ASSEMBLE INNER INSULATOR, INTERMEDIATE CONTACT AND OUTER INSULATOR, THEN INSERT INTO THE BODY. SLIDE THE BACK END PARTS FORWARD. THREAD ASSEMBLY INTO THE CONNECTOR BODY AND TIGHTEN WITH 5 IN. LBS. MIN. AND 30 IN. LBS MAX TORQUE.

TRIM CODE CHART			
A	B	C	D
1.03	.75	.32	.156



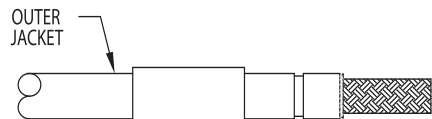
1. CUT CABLE END SQUARE, SLIDE K-GRIP SLEEVE OVER JACKET AND MAKE CUTS 1 AND 2 IN OUTER JACKET ONLY.



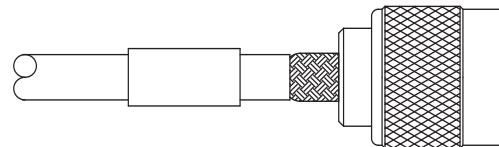
4. TRIM DIELECTRIC TO DIMENSION .344 EXPOSED CENTER CONDUCTOR LENGTH WILL BE EQUAL TO 3/16 DIMENSION.



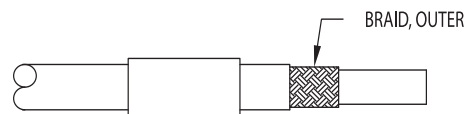
5. SOLDER OR CRIMP CONTACT TO CENTER CONDUCTOR.



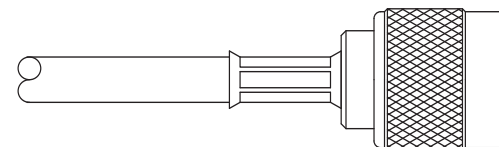
2. REMOVE OUTER JACKET TO .281 DIMENSION, FLARE OR BULGE BACK BRAID AND TRIM WITH SCISSORS AT EDGE OF OUTER JACKET



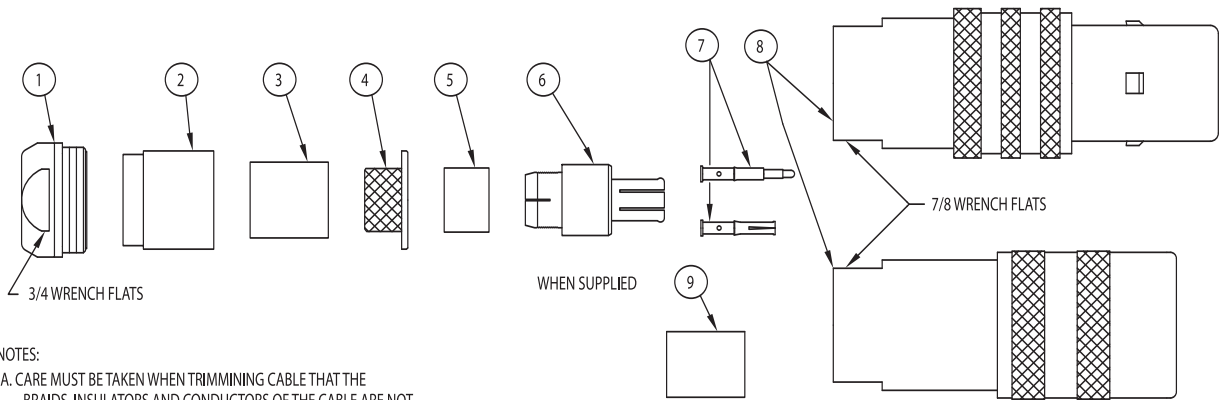
6. PUSH K-GRIP JR. OVER DIELECTRIC AND UNDER BOTH BRAIDS UNTIL DIELECTRIC BOTTOMS IN CONNECTOR.



3. REMOVE JACKET TO .250 DIMENSION.

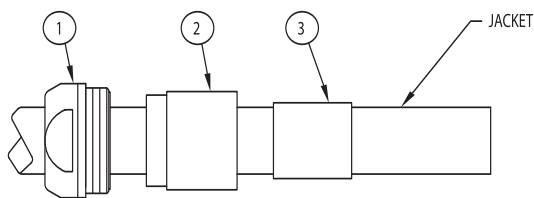


7. SLIDE K-GRIP SLEEVE AGAINST SHOULDER ON BODY AND FORM BY CRIMPING.

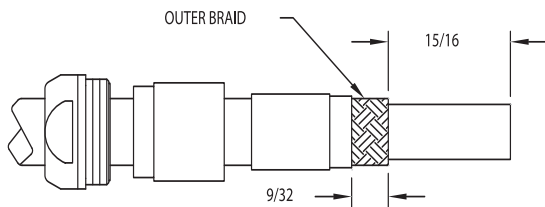


**NOTES:**

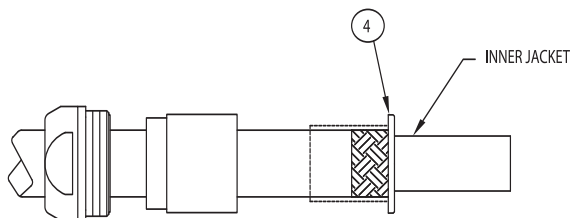
- A. CARE MUST BE TAKEN WHEN TRIMMING CABLE THAT THE BRAIDS, INSULATORS AND CONDUCTORS OF THE CABLE ARE NOT NICKED OR DAMAGED.
- B. WHEN A THREE CAVITY DIE IS USED THE FIRST CRIMP ON THE OUTER BRAID (STEP 3) IS DONE WITH THE LARGEST CAVITY. ASSEMBLE DIE IN CRIMP TOOL FRAME USING SHANKS AJACENT TO THAT CAVITY. REVERSE THE DIE IN THE TOOL USING OTHER SHANKS WHEN CRIMPING CENTER CONTACT (STEP 5) AND INNER BRAID (STEP 6).



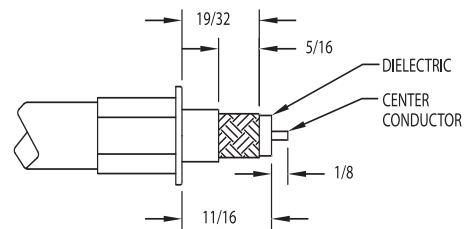
1. CUT CABLE END SQUARE. PLACE CLAMP NUT ASSEMBLY (ITEM 1), SPACER (ITEM 2) AND LARGE CRIMP SLEEVE (ITEM 3) OVER THE JACKET.



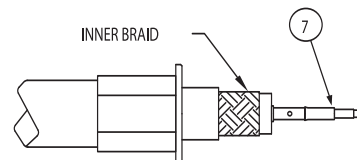
2. REMOVE JACKET AND OUTER BRAID TO 15/16 DIM. THEN REMOVE JACKET AN ADDITIONAL 9/32 EXPOSING OUTER BRAID.



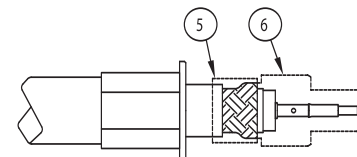
3. SLIDE K-GRIP (ITEM 4) OVER INNER JACKET AND UNDER OUTER BRAID. HOLD IN POSITION AND MOVE CRIMP SLEEVE FORWARD AGAINST SHOULDER AND CRIMP IN PLACE USING APPROPRIATE HEX DIE.



- 4 A. REMOVE INNER JACKET AND INNER BRAID TO 19/32 DIM. REMOVE INNER JACKET AN ADDITIONAL 5/16 EXPOSING INNER BRAID.  
B. REMOVE DIELECTRIC TO 11/16 DIM. AND CUT CENTER CONDUCTOR TO BE 1/8 LONG.



5. PLACE THE MALE OR FEMALE CONNECTOR CONTACT (ITEM 7) ON THE CABLE CENTER CONDUCTOR, BOTTOM AGAINST DIELECTRIC AND SOLDER OR CRIMP IN PLACE.

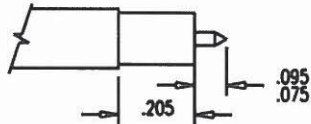


6. PLACE SMALL SLEEVE (ITEM 5) OVER INNER BRAID OF CABLE. SLIDE BODY ASSEMBLY (ITEM 6) OVER THE DIELECTRIC AND UNDER THE INNER BRAID UNTIL THE CENTER CONTACT LOCKS IN PLACE IN BODY ASSEMBLY. (NOTE: CAUTION MUST BE EXERCISED NOT TO ALLOW ANY BRAID STRANDS TO REMAIN INSIDE THE BODY ASSEMBLY. ALL BRAID MUST BE ON THE OUTSIDE OF THE BODY). SLIDE CRIMP SLEEVE FORWARD OVER BOTH THE BODY AND BRAID TO THE BODY SHOULDER. CRIMP IN PLACE. PUSH ALL LOOSE PARTS FORWARD ON CABLE AND INSERT INTO MAIN CONNECTOR BODY (ITEM 8). THREAD CLAMP NUT ASSEMBLY INTO BODY AND LOCK SECURELY.

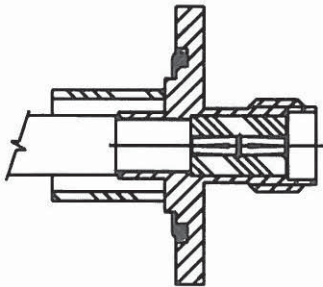
"U" SPACER, ITEM 9 IS SUPPLIED ONLY WITH SMALL CABLE CONNECTORS. IT IS PLACED OVER ITEM 5 AFTER CRIMPING & BEFORE THREADING CABLE ASSEMBLY INTO BODY.  
RECOMMENDED TORQUE: 80 IN LBS.

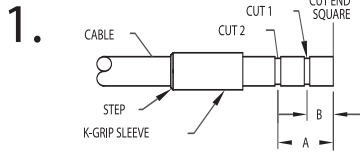
## CABLING PROCEDURE FOR M17/130-00004

1. CUT CABLE END SQUARE
2. WHEN USING T-FLEX402HF CABLE SOLDER DIP CABLE PER SHEET 2 OF 3-648.
3. TRIM CABLE TO DIMENSIONS SHOWN.
5. SOLDER CABLE IN BODY

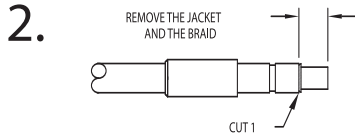


4. INSERT TRIMMED CABLE INTO CONNECTOR.  
BOTTOM CABLE AGAINST INSULATOR (ASSEMBLE MATING CONNECTOR  
TO PREVENT INSULATOR MOVEMENT).

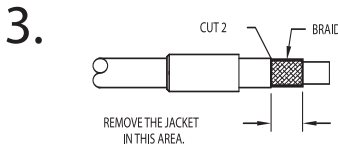




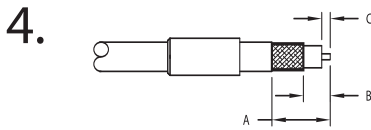
1. CUT THE CABLE-END SQUARE. SLIDE THE K-GRIP SLEEVE ONTO THE CABLE. MAKE "CUT 1" AND "CUT 2" IN THE JACKET.



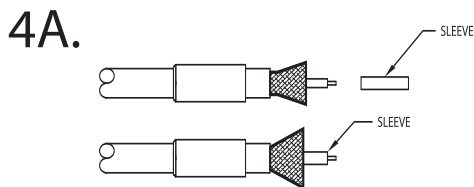
2. REMOVE THE JACKET AND THE BRAID TO DIMENSION B. TO REMOVE THE BRAID: FLARE BACK OR BULGE BACK THE BRAID AND TRIM WITH SCISSORS AT "CUT 1"



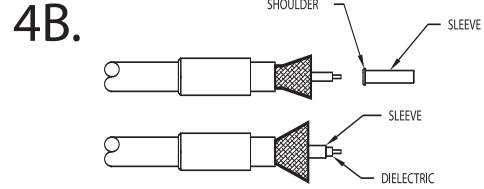
3. REMOVE JACKET TO DIMENSION A



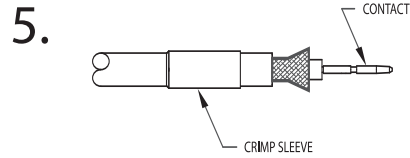
4. TRIM DIELECTRIC FROM CABLE END TO DIMENSION "C". EXPOSED CENTER CONDUCTOR LENGTH WILL BE EQUAL TO DIMENSION "C".



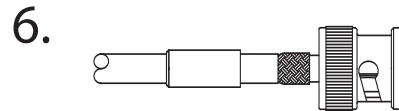
4A. FLARE BRAID TO PERMIT INSERTION OF SLEEVE, SHOULDER END FIRST, OVER DIELECTRIC AND UNDER BRAID.



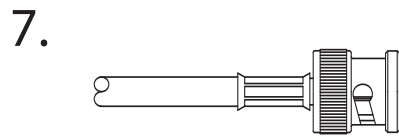
4A. FLARE BRAID TO PERMIT INSERTION OF SLEEVE, SHOULDER END FIRST, OVER DIELECTRIC AND UNDER BRAID. A SHORT LENGTH OF DIELECTRIC SHOULD BE VISIBLE.



5. WITH THE BRAID FLARED, SLIDE CONTACT INTO POSITION AND CRIMP CONTACT TO CENTER CONDUCTOR.



6. PUSH K-GRIP JR. OVER DIELECTRIC & UNDER BRAID UNTIL CENTER CONTACT IS LOCKED IN INSULATOR (THIS CAN BE CHECKED BY APPLYING SLIGHT FINGER PRESSURE TO THE CABLE).



7. SLIDE K-GRIP SLEEVE AGAINST SHOULDER ON BODY AND FORM BY CRIMPING.

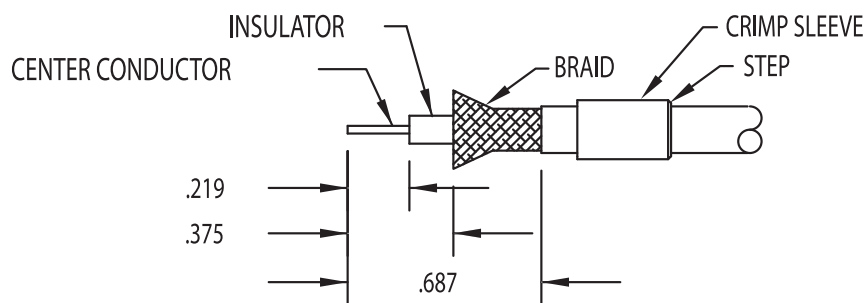
#### NOTES:

1. STEP 4A APPLIES ONLY TO CONNECTORS SUPPLIED W/PLASTIC SLEEVE
2. STEP 4B APPLIES ONLY TO CONNECTORS SUPPLIED W/METAL SLEEVE

DASH NO	A	B	C
-1	.624	.312	.155
-2	.624	.312	.249
-3	.687	.375	.187
-4	.668	.356	.200
-5	.687	.375	.219
-6	.540	.250	.150

## 735 CABLE INSTALLATION INSTRUCTIONS USING KINGS DIE SET KTH-2185

1. SLIDE CRIMP SLEEVE ONTO CABLE WITH STEP LOCATED AWAY FROM THE CONNECTOR BODY.



3. SLIDE THE CONTACT ALL THE WAY ONTO THE CENTER CONDUCTOR. BE SURE THAT CONTACT BUTTS AGAINST THE DIELECTRIC. CRIMP CONTACT TO CENTER CONDUCTOR. REQUIRED DIE FLAT DIMENSIONS ARE .042". USE OF APPROVED 12 POINT CRIMP TOOLS IS OPTIONAL.
4. SLIGHTLY FAN OUT THE BRAID AT THE END. PUSH CABLE INTO CONNECTOR UNTIL CONTACT SNAPS INTO PLACE. ALL BRAID WIRES MUST BE OVER THE SUPPORT SLEEVE. FOIL MUST BE UNDER SUPPORT SLEEVE.
5. DRESS THE BRAID EVENLY AROUND THE SUPPORT SLEEVE. SLIDE CRIMP SLEEVE FORWARD OVER BRAID AND AGAINST CONNECTOR. FORM BY CRIMPING. REQUIRED DIE FLAT DIMENSIONS ARE .178".

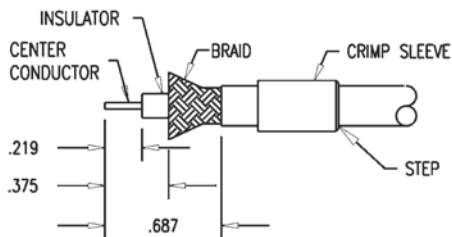


INSTALLATION INSTRUCTIONS

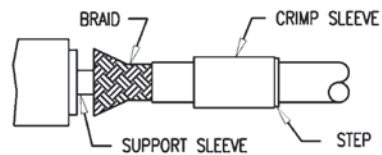
CARD COLOR RED/BLACK MARKING

FOR 735-TYPE CABLE USING KTH-2185

1. SLIDE CRIMP SLEEVE ONTO CABLE WITH STEP LOCATED AWAY.
2. STRIP CABLE AS SHOWN BELOW. THE LENGTHS IN THIS PICTURE ARE ACTUAL SIZE AND MAY BE USED AS GAUGE.



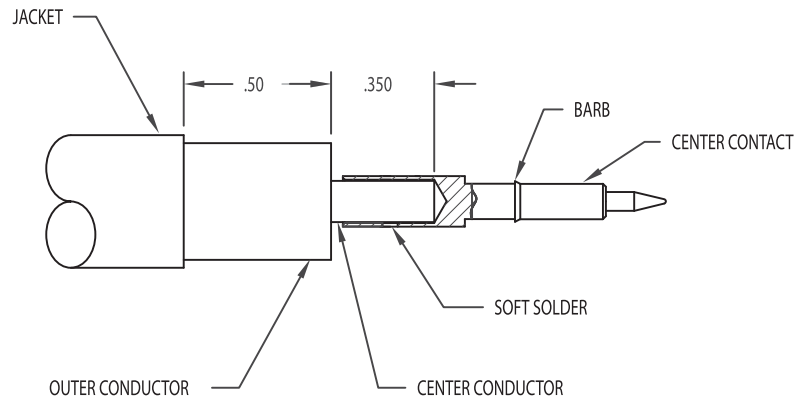
3. SLIDE THE CONTACT ALL THE WAY ON TO THE CENTER CONDUCTOR. BE SURE THAT CONTACT BUTTS AGAINST THE DIELECTRIC. CRIMP CONTACT TO CENTER CONDUCTOR. REQUIRED DIE FLAT DIMENSIONS ARE .042". USE OF APPROVED 12 POINT CRIMP TOOLS IS OPTIONAL.



4. SLIGHTLY FAN OUT THE BRAID AT THE END. PUSH CABLE INTO CONNECTOR UNTIL CONTACT SNAPS INTO PLACE. ALL BRAID WIRES MUST BE OVER THE SUPPORT SLEEVE. FOIL MUST BE UNDER SUPPORT SLEEVE.

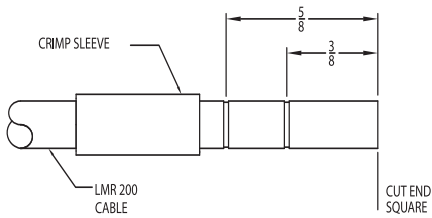
5. DRESS THE BRAID EVENLY AROUND THE SUPPORT SLEEVE. SLIDE CRIMP SLEEVE FORWARD OVER BRAID AND AGAINST CONNECTOR. FORM BY CRIMPING. REQUIRED DIE FLAT DIMENSIONS ARE .178".

FOR TECHNICAL SUPPORT CALL (888) 909-5551.



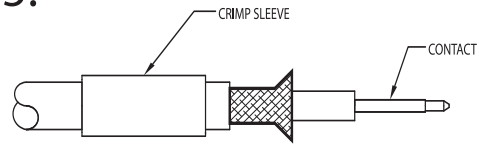
- 1) TRIM CABLE AS SHOWN. CARE MUST BE TAKEN TO AVOID METAL PARTICLES ON DIELECTRIC FACE.
- 2) BOTTOM CABLE CENTER CONDUCTOR IN CONTACT WIRE HOLE. HOLD IN POSITION AND SOFT SOLDER.
- 3) INSERT CONTACT INTO BODY ASSEMBLY AND PUSH CONTACT BARB INTO TEFLON INSULATOR UNTIL CABLE BOTTOMS IN BODY.
- 4) SOFT SOLDER BODY TO CABLE OUTER CONDUCTOR.

1.



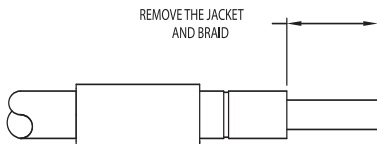
1. CUT THE CABLE-END SQUARE. SLIDE THE CRIMP SLEEVE ONTO THE CABLE. MAKE CUTS IN THE JACKET AT 3/8" AND 5/8" FROM THE END OF THE CABLE.

5.



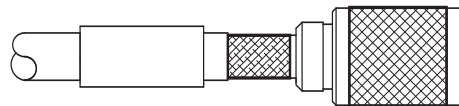
5. SLIGHTLY FLARE THE BRAID AND SLIDE CONTACT INTO POSITION AND CRIMP CONTACT TO CENTER CONDUCTOR USING KTH-1000 CRIMP TOOL AND KTH-2026 DIE SET.

2.



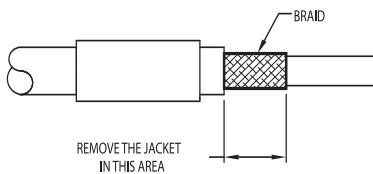
2. REMOVE THE JACKET AND BRAID TO THE FIRST CUT, 3/8" FROM THE CABLE-END. TO REMOVE THE BRAID, FLARE BACK OR BULGE THE BRAID AND TRIM WITH SCISSORS.

6.



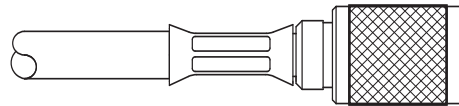
6. PUSH K-GRIP OF CONNECTOR OVER DIELECTRIC AND FOIL AND UNDER THE CABLE BRAID UNTIL THE DIELECTRIC BOTTOMS IN THE CONNECTOR.

3.



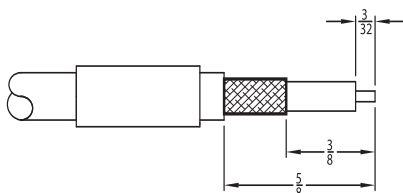
3. REMOVE THE JACKET TO THE SECOND CUT, 5/8" FROM CABLE-END.

7.



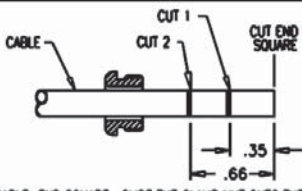
7. SLIDE CRIMP SLEEVE OVER K-GRIP AND BRAID TO THE CONNECTOR BODY SHOULDER. CRIMP IN PLACE USING KTH-1000 CRIMP TOOL AND KTH-2026 DIE SET.

4.

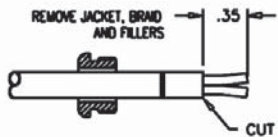


4. TRIM DIELECTRIC 3/32" FROM CABLE END TO EXPOSE CENTER CONDUCTOR.

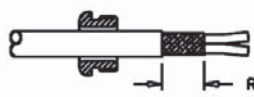
NOTES:  
NO SPECIFIC ORIENTATION FOR CRIMP SLEEVE.

1. 

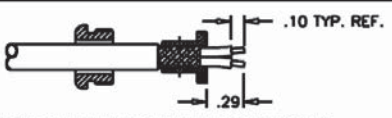
1. CUT THE CABLE-END SQUARE. SLIDE THE CLAMP NUT ONTO THE CABLE. MAKE CUT 1 AND CUT 2 IN THE JACKET.

2. 

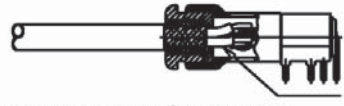
2. REMOVE JACKET, BRAID AND FILLERS TO .35 DIMENSION. TO REMOVE THE BRAID: FLARE BACK OR BULGE BACK THE BRAID AND TRIM WITH SCISSORS AT "CUT 1".

3. 

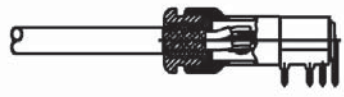
3. REMOVE CABLE OUTSIDE JACKET TO LEAVE BRAID EXPOSED.

4. 

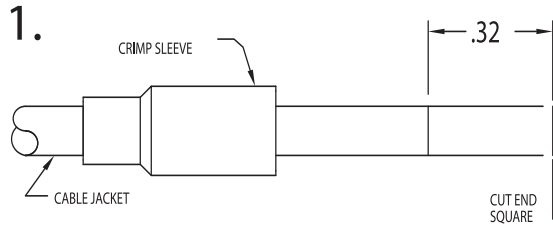
4. INSERT SOLDER TAIL OVER THE BRAID UNTIL BOTTOMED. SOFT SOLDER IN PLACE, USING RMA SOLDER. HEAT AND APPLY SOLDER INTO THE (2) SMALLER SOLDER HOLES. AFTER SOLDERING, TRIM & STRIP WIRES TO DIMENSIONS AS SHOWN.

5. 

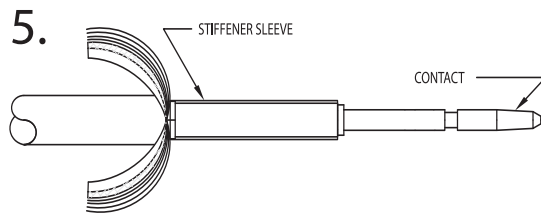
5. INSERT SHRINK INSULATION TUBING P/N 1-8449 OVER THE WHITE WIRE. SECURE CABLE AND SOLDER TAIL TO CONNECTOR ASSEMBLY. SOLDER WHITE SLEEVE WIRE TO CENTER CONTACT. SOLDER CLEAR SLEEVE WIRE TO INTERMEDIATE CONTACT. MAKE SURE NOT TO HAVE ANY SOLDER BRIDGE BETWEEN CENTER AND INTERMEDIATE CONTACTS. HEAT SHRINK INSULATION TUBING P/N 1-8449 OVER THE CENTER CONTACT/WHITE WIRE SOLDER JOINT AS SHOWN.

6. 

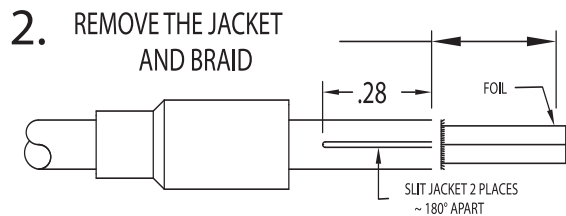
6. TORQUE CLAMP NUT TO BODY ASSEMBLY AND LOCK SECURELY. RECOMMENDED TORQUE: 20-26 IN.-LBS. STAKE 1 PLACE ON BODY AS A THREADLOCK FEATURE TO LOCK CLAMP NUT IN PLACE.



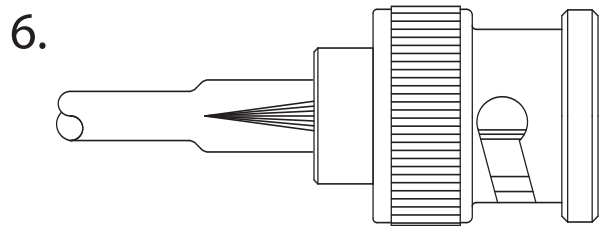
1. CUT THE CABLE-END SQUARE. SLIDE THE CRIMP SLEEVE ONTO THE CABLE. MAKE CUTS IN THE JACKET AT .32" FROM THE END OF THE CABLE.



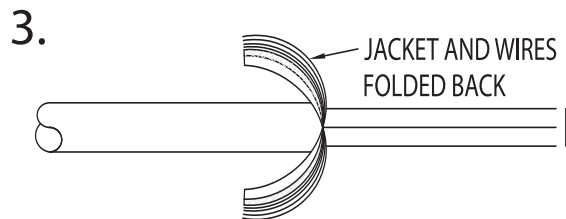
5. SLIDE STIFFENER SLEEVE OVER CABLE DIELECTRIC. CRIMP CONTACT INTO PLACE WITH NAIL HEAD AGAINST DIELECTRIC.



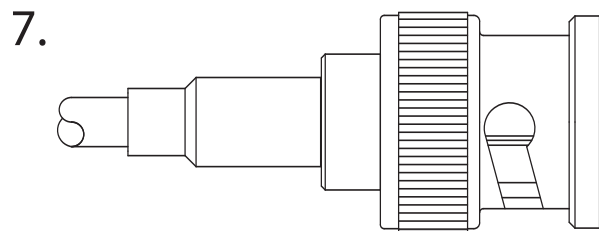
2. REMOVE THE JACKET AND BRAID TO THE FIRST CUT. SLIT THE JACKET 2 PLACES AS SHOWN. .28 LONG.



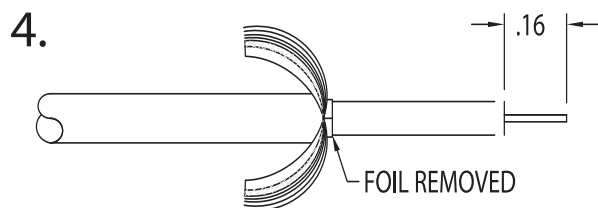
6. INSERT CONTACT INTO K-GRIP OF CONNECTOR AND SNAP INTO PLACE. FOLD WIRE AND JACKET SECTIONS OVER K-GRIP.



3. FOLD BACK TWO JACKET SECTIONS ALONG WITH OUTER CONDUCTOR WIRE STRANDS.



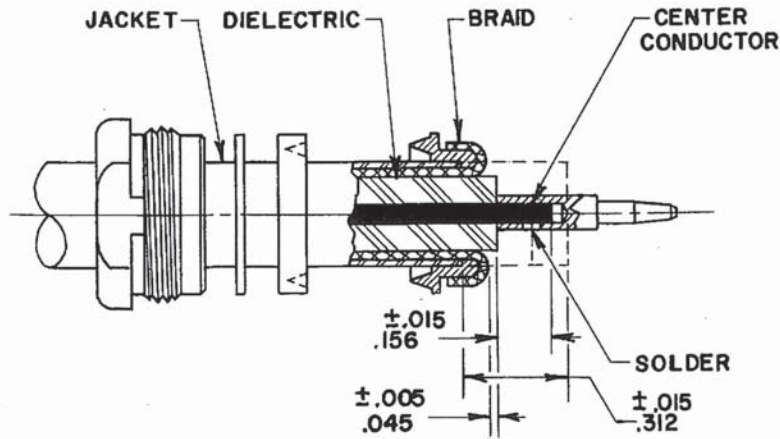
7. SLIDE CRIMP SLEEVE OVER K-GRIP AND JACKET TO THE CONNECTOR BODY SHOULDER AND CRIMP IN PLACE.



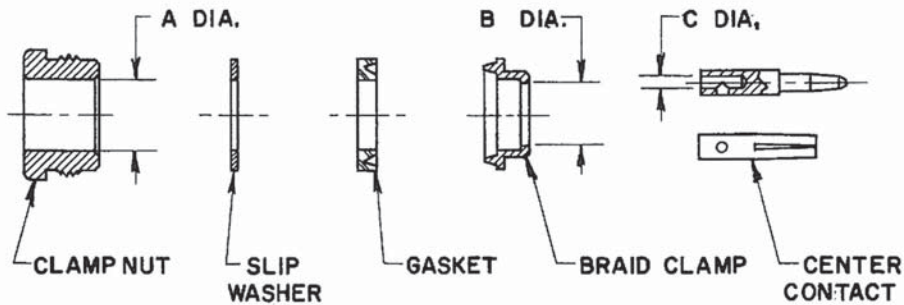
4. REMOVE FOIL AS CLOSE TO FOLDED BACK JACKET AS POSSIBLE. TRIM DIELECTRIC AS SHOWN.

NOTES:

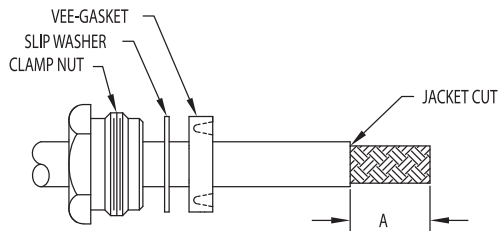
1. LARGE I.D. OF CRIMP SLEEVE TO GO OVER K-GRIP BODY OF CONNECTOR.



1. WITH CLAMP NUT, SLIP WASHER & GASKET ON CABLE, REMOVE JACKET TO  $.312 \pm .015$  DIM.
2. SLIDE BRAID CLAMP OVER BRAID AGAINST JACKET EDGE. COMB OUT BRAID WIRES, FOLD BACK OVER BRAID CLAMP & TRIM AS SHOWN.
3. REMOVE DIELECTRIC TO  $.045 \pm .005$  DIM. & TRIM CENTER CONDUCTOR TO  $.156 \pm .015$  DIM.
4. SOLDER CENTER CONTACT TO CENTER CONDUCTOR.
5. THREAD ASSEMBLY SECURELY INTO CONNECTOR BODY. RECOMMENDED TORQUE: 55-60 IN.LBS.

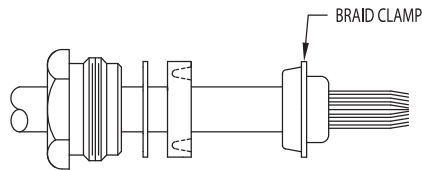


MILITARY PART NUMBER	KINGS NUMBER	CABLE USAGE	PIECE PART DIM'S.		
			A DIA.	B DIA.	C DIA.
M39012/06-0001 M39012/08-0002 M39012/11-0001	KD-59-132 KD-19-71 KD-19-61	RG-5,6,21,143, 212,222,304/U	.35	.27	.06
M39012/06-0002 M39012/08-0001 M39012/11-0002	KD-59-119 KD-19-72 KD-19-73	RG-8,9,213, 214/U	.44	.37	.10

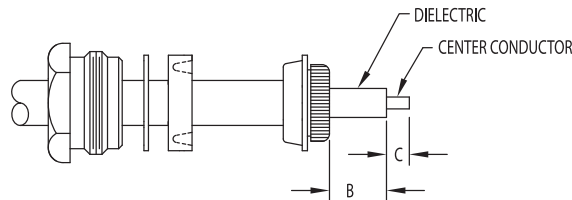


1. CUT CABLE END SQUARE, PLACE CLAMP NUT, SLIP WASHER (WHEN SUPPLIED) AND VEE-GASKET OVER JACKET. REMOVE JACKET TO DIMENSION "A".

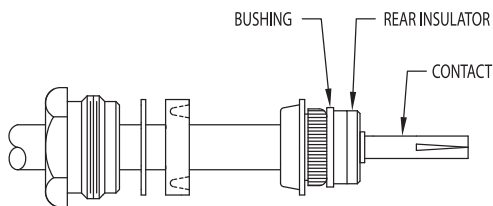
TRIM CODE CHART			
DASH NO.	A	B	C
-1	.625	.288	.218



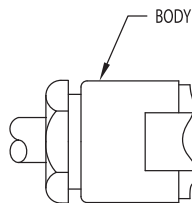
2. COMB OUT BRAID AND TAPER FORWARD. PLACE BRAID CLAMP OVER BRAID AGAINST JACKET CUT.



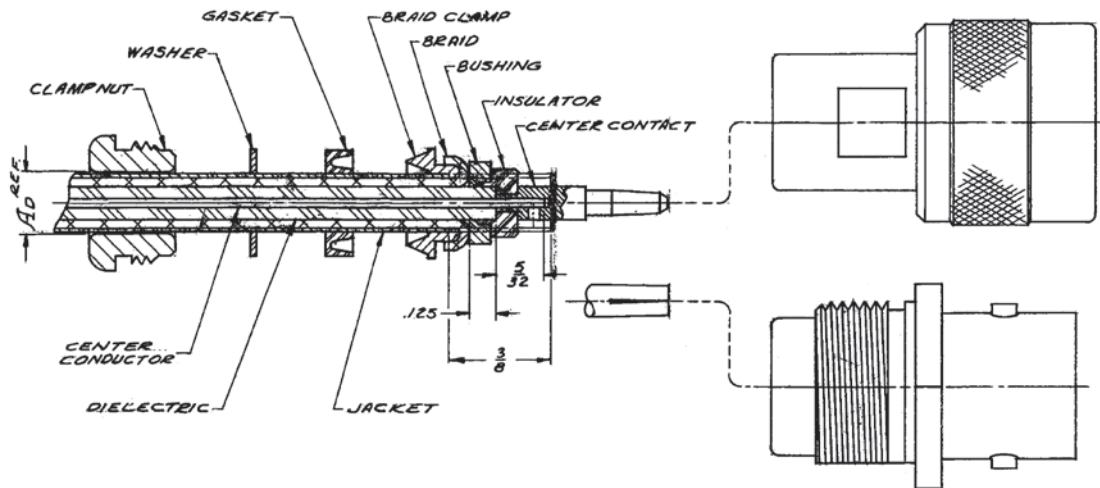
3. FOLD OUTER BRAID BACK OVER BRAID CLAMP AND TRIM AS SHOWN. REMOVE INNER JACKET TO EDGE OF OUTER BRAID. COMB OUT INNER BRAID AND FOLD BACK OVER OUTER BRAID AND BRAID CLAMP. TRIM INNER BRAID AS SHOWN. REMOVE DIELECTRIC TO DIMENSION "B". CUT CENTER CONDUCTOR TO DIMENSION "C".



4. PLACE BUSHING AND REAR INSULATOR OVER DIELECTRIC AND AGAINST BRAID CLAMP AS SHOWN. SOLDER OR CRIMP (WHEN APPLICABLE) CONTACT TO CENTER CONDUCTOR.

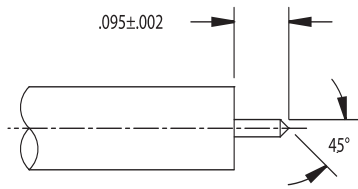


5. PLACE FRONT INSULATOR OVER CONTACT. THREAD ASSEMBLY INTO CONNECTOR BODY AND LOCK SECURELY. VEE-GASKET MUST BE SPLIT BY BRAID CLAMP. (35-40 IN-LBS RECOMMENDED TORQUE).

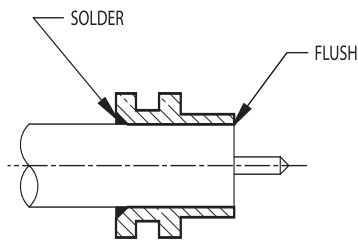


1. CUT CABLE END SQUARE. SLIDE CLAMP NUT, WASHER & GASKET OVER JACKET.
2. REMOVE JACKET TO 3/8 DIMENSION WITHOUT NICKING BRAID.
3. SLIDE BRAID CLAMP OVER BRAID AND BUTT AGAINST JACKET SHOULDER.
4. COMB OUT BRAID WIRES, FLARE OVER BRAID CLAMP SHOULDER AND TRIM AS SHOWN.
5. REMOVE DIELECTRIC TO .125 DIMENSION. DO NOT NICK CENTER CONDUCTOR.
6. CUT CENTER CONDUCTOR TO 5/32 DIMENSION AND TIN.
7. ASSEMBLE BUSHING, INSULATOR AND CENTER CONTACT ON CABLE AS SHOWN. SOLDER CONTACT IN POSITION WITHOUT DISTORTING DIELECTRIC BY OVER HEATING.
8. THREAD ASSEMBLY INTO CONNECTOR BODY AND TIGHTEN SUFFICIENTLY TO SPLIT GASKET AND INSURE GOOD CONTACT BETWEEN BRAID CLAMP AND WASHER.

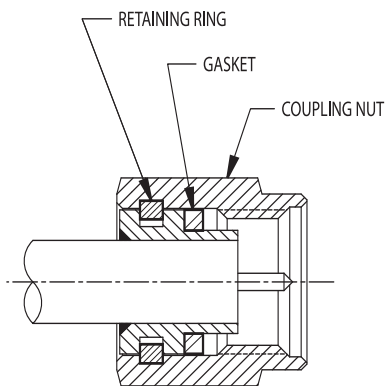




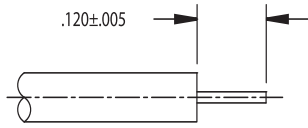
1. TRIM CABLE TO DIMENSIONS SHOWN. DO NOT NICK CENTER CONDUCTOR. CHAMFER CENTER CONDUCTOR AS SHOWN.



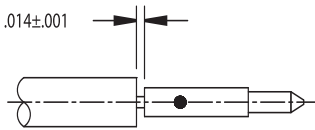
2. INSERT CABLE INTO BODY. BODY AND CABLE TO BE FLUSH AT INTERFACE. SOLDER CABLE INTO BODY. TRIM ANY EXCESS DIELECTRIC MATERIAL.



3. ASSEMBLE GASKET, RETAINING RING, AND COUPLING NUT.



1. TRIM CABLE TO DIMENSIONS SHOWN. DO NOT NICK CENTER CONDUCTOR.



2. SOLDER CONDUCTOR TO CENTER CONTACT. LEAVE GAP AS SHOWN. CLEAN.

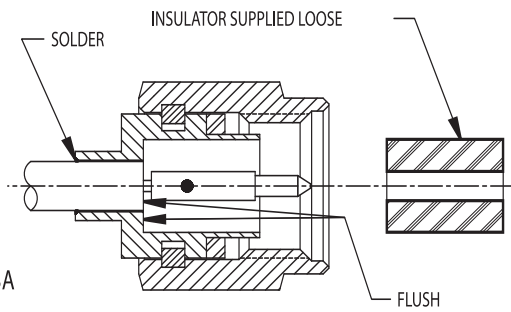


FIG. 3A

3. FOR CONNECTORS WITH INSULATORS SUPPLIED LOOSE: INSERT CABLE INTO BODY UNTIL CABLE IS FLUSH WITH SHOULDER IN BODY. SOLDER CABLE INTO BODY. TRIM ANY EXCESS DIELECTRIC MATERIAL. CLEAN. REFER TO FIG. 3A. FOR CONNECTORS WITH INSULATORS INSTALLED: INSERT CABLE INTO BODY UNTIL IT BUTTS AGAINST INSULATOR. SOLDER CABLE INTO BODY. CLEAN. REFER TO FIG. 3B.

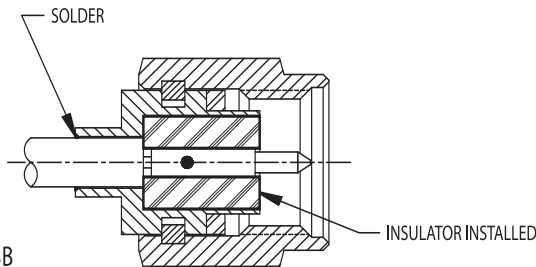
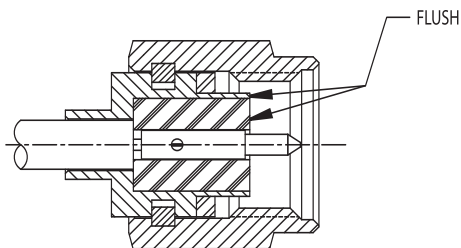
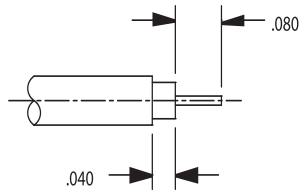


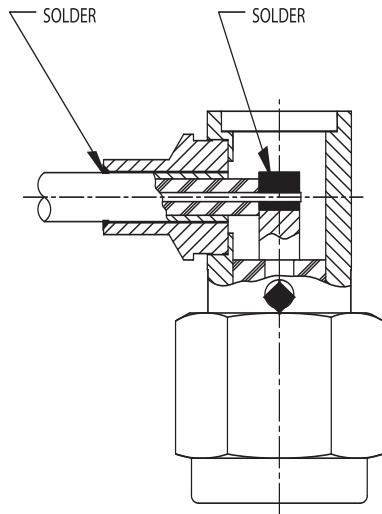
FIG. 3B



4. FOR CONNECTORS WITH INSULATORS SUPPLIED LOOSE: PRESS IN INSULATOR FLUSH TO BODY.

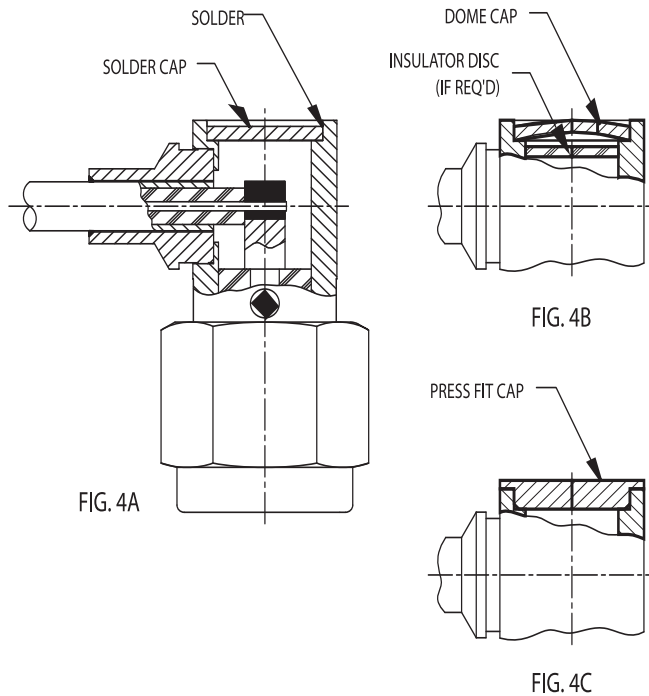


1. TRIM CABLE TO DIMENSIONS SHOWN. DO NOT NICK CENTER CONDUCTOR.

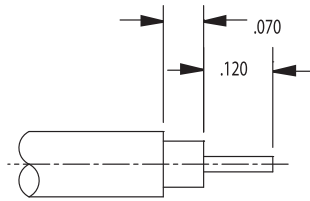


2. INSERT CABLE INTO BODY. DIELECTRIC MUST BUTT AGAINST CENTER CONTACT, AND CENTER CONDUCTOR MUST ENTER SLOT IN CONTACT. SOLDER CABLE INTO BODY. CLEAN.

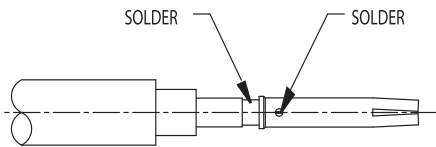
3. SOLDER CONDUCTOR INTO SLOT THROUGH REAR ACCESS HOLE. CLEAN.



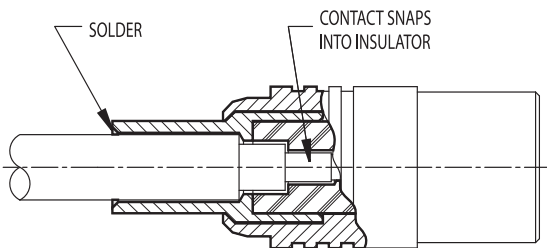
4. ASSEMBLE CAP INTO BODY:  
 FOR FLAT CAPS, SOLDER CAP INTO BODY AND CLEAN (SEE FIG. 4A)  
 FOR DOME CAPS, PLACE INSULATOR DISC (IF REQUIRED) INTO BODY. PLACE CAP IN BODY WITH DOME UP AND PRESS OR DIMPLE CAP. (SEE FIG. 4B)  
 FOR PRESS FIT CAPS, PRESS CAP INTO BODY. (SEE FIG. 4C)



1. TRIM CABLE TO DIMENSION SHOWN. DO NOT NICK CENTER CONDUCTOR.

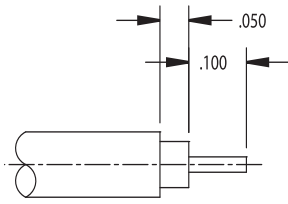


2. SOLDER CONTACT TO CENTER CONDUCTOR. CLEAN.

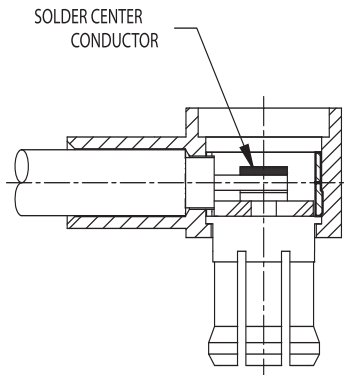


3. INSERT CENTER CONTACT INTO BODY UNTIL IT SNAPS INTO INSULATOR.

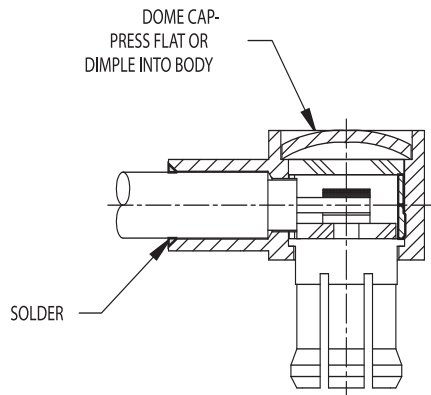
4. SOLDER CABLE JACKET TO BODY. CLEAN.



1. TRIM CABLE TO DIMENSION SHOWN. DO NOT NICK CENTER CONDUCTOR.



2. INSERT CABLE INTO BODY UNTIL CABLE BOTTOMS IN BODY. CENTER CONDUCTOR MUST ENTER SLOT IN CONTACT. SOLDER CONTACT. CLEAN.

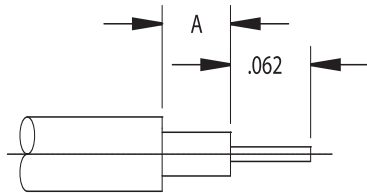


3. SOLDER CABLE JACKET INTO BODY. CLEAN.

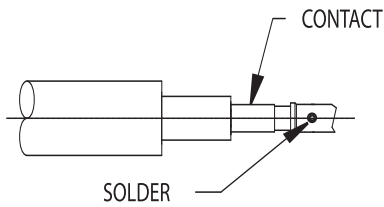
4. PLACE INSULATOR INTO ACCESS HOLE OVER CONTACT.

5. PLACE DOME CAP INTO BODY AND PRESS FLAT OR DIMPLE.

PART NUMBER		A
470-500-0470	471-500-0470	.040
470-500-0850	471-500-0850	.050

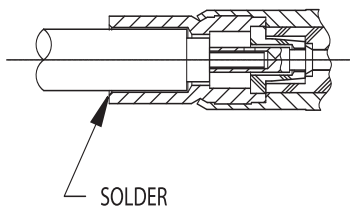


1. Trim cable to dimension shown. Do not nick center conductor.



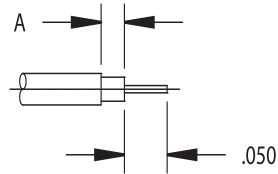
2. Solder contact to center conductor. Clean.

3. Insert center contact into body until it snaps into insulator.

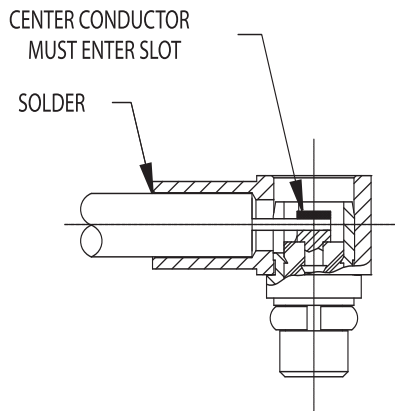


4. Solder cable jacket to body. Assure cable jacket bottoms in connector body while soldering. Allow to cool. Clean.

PART NUMBER	A
472-500-0470	.040
472-500-0850	.050

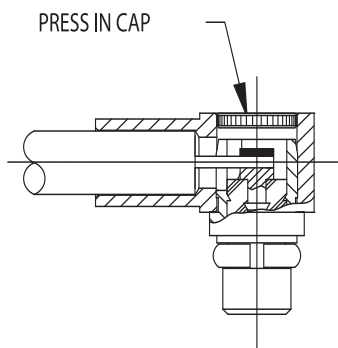


1. Trim cable to dimensions shown. Do not nick center conductor.

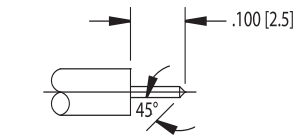


2. Insert cable into body until it butts. Center conductor must enter slot of contact.

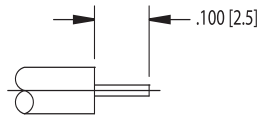
3. Solder cable jacket into body. Assure cable jacket bottoms in connector body while soldering. Allow to cool. Clean.



4. Solder center conductor of cable into slot of contact. Allow to cool. Clean. Press cap into body.



FOR RG-402 (Ø.141) CABLE



FOR RG-405 (Ø.085) CABLE

FIGURE 1

1. TRIM CABLE TO DIMENSIONS SHOWN. DO NOT NICK CENTER CONDUCTOR. (SEE FIG. 1)

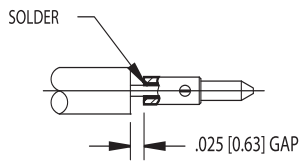


FIGURE 2

\*\*\*SKIP THIS STEP WHEN USING RG-402 (Ø.141) CABLE\*\*\*

2. SLIDE CENTER CONDUCTOR OF CABLE INTO REAR CONTACT. SET GAP BETWEEN CONTACT AND DIELECTRIC OF CABLE. SOLDER. CLEAN. (SEE FIG. 2)

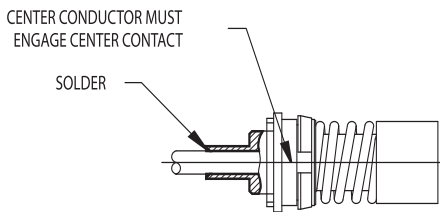


FIGURE 3

2. INSERT CABLE INTO BODY UNTIL IT BUTTS UP AGAINST COUNTERBORE. CENTER CONDUCTOR MUST ENGAGE TINES IN CENTER CONTACT. SOLDER OUTER CONDUCTOR OF CABLE TO BODY. CLEAN. (SEE FIG. 3)



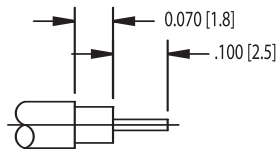


FIGURE 1

1. TRIM CABLE TO DIMENSIONS SHOWN. DO NOT NICK CENTER CONDUCTOR. (SEE FIG. 1)

2. INSERT CABLE INTO BODY UNTIL IT BUTTS UP AGAINST COUNTERBORE. CENTER CONDUCTOR MUST ENTER SLOT IN CENTER CONTACT. SOLDER OUTER CONDUCTOR OF CABLE TO BODY. CLEAN. (SEE FIG. 2)

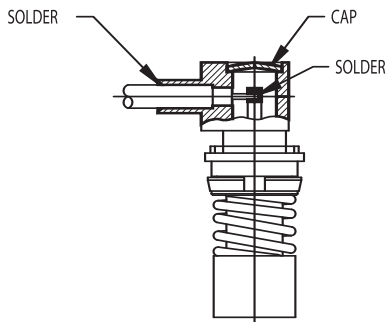
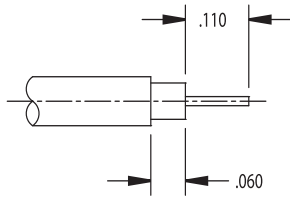


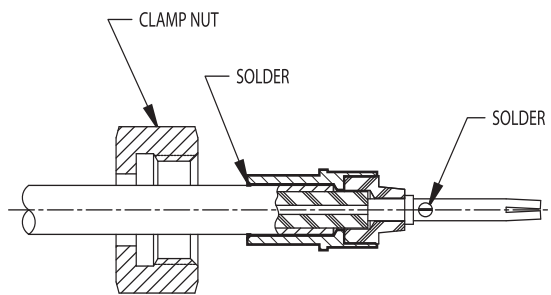
FIGURE 2

3. SOLDER CENTER CONDUCTOR OF CABLE TO CENTER CONTACT. CLEAN. (SEE FIG. 2)

4. PLACE CAP INTO BODY AS SHOWN AND DEPRESS CAP TO EXPAND INSIDE COUNTERBORE OF BODY. (SEE FIG. 2)

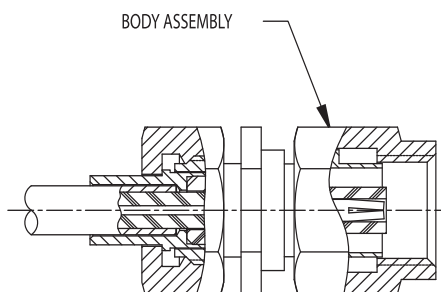


1. TRIM CABLE TO DIMENSIONS SHOWN. DO NOT NICK THE CENTER CONDUCTOR.

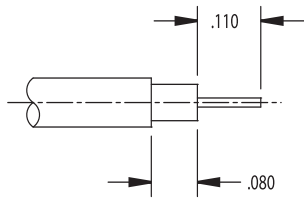


2. SLIDE CLAMP NUT OVER CABLE. INSERT CABLE INTO SLEEVE ASSEMBLY. CENTER CONDUCTOR MUST PASS THROUGH HOLE IN INSULATOR. CABLE JACKET MUST BUTT AGAINST SHOULDER INSIDE SLEEVE. SOLDER CABLE INTO SLEEVE. CLEAN.

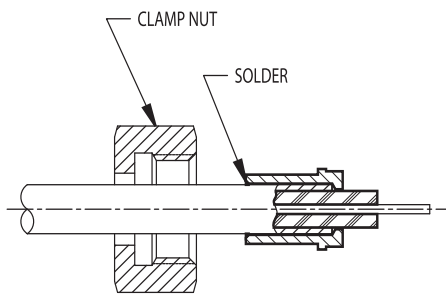
3. ASSEMBLE CENTER CONTACT TO CENTER CONDUCTOR BY INSERTING INTO HOLE OF INSULATOR. SOLDER CONDUCTOR THROUGH HOLE IN CONTACT. CLEAN.



4. ASSEMBLE SLEEVE ASSEMBLY TO BODY. SLIDE CLAMP NUT FORWARD AND CLAMP SLEEVE TO BODY. TORQUE CLAMP NUT TO 8 IN.-LBS.

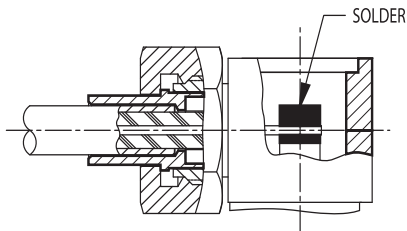


1. TRIM CABLE TO DIMENSIONS SHOWN. DO NOT NICK THE CENTER CONDUCTOR.



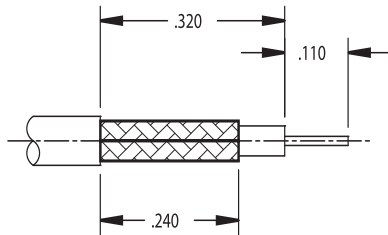
2. SLIDE CLAMP NUT OVER CABLE. INSERT CABLE INTO SLEEVE DIELECTRIC MUST PASS THROUGH HOLE IN SLEEVE. CABLE JACKET MUST BUTT AGAINST SHOULDER INSIDE SLEEVE. SOLDER CABLE INTO SLEEVE. CLEAN.

3. SOLDER CONDUCTOR INTO SLOT IN CONTACT THROUGH REAR ACCESS HOLE. CLEAN.

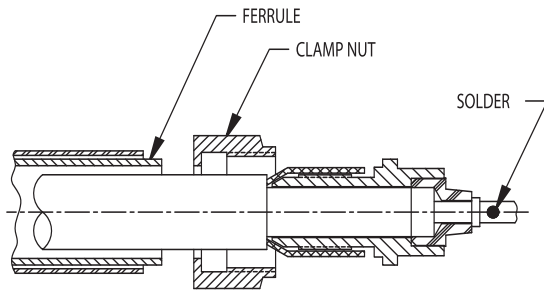


4. ASSEMBLE SLEEVE ASSEMBLY TO BODY. SLIDE CLAMP NUT FORWARD AND CLAMP SLEEVE TO BODY. TORQUE CLAMP NUT TO 8 IN.-LBS. PRESS CAP INTO BODY.

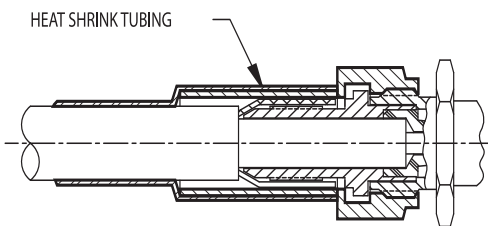
PART NUMBER			FERRULE HEX SIZE
510-800-0360	511-680-0360	511-880-0360	.105
510-800-0630	511-680-0630	511-880-0630	.128
510-800-0631	511-680-0361	511-880-0631	.151



1. TRIM CABLE TO DIMENSIONS SHOWN. DO NOT NICK CENTER CONDUCTOR.

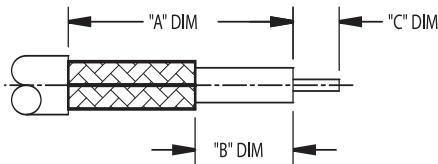


2. SLIDE SHRINK TUBING, FERRULE, AND CLAMP NUT OVER CABLE. INSERT CABLE INTO WEDGE ASSEMBLY. CENTER CONDUCTOR MUST ENTER AND PROTRUDE THROUGH HOLE IN INSULATOR. DIELECTRIC OF CABLE MUST BUTT AGAINST INSULATOR IN WEDGE. ASSEMBLE CENTER CONTACT TO WEDGE ASSEMBLY BY INSERTING CONTACT INTO HOLE IN INSULATOR. SOLDER CONTACT TO CENTER CONDUCTOR THROUGH HOLE IN CONTACT. CLEAN.

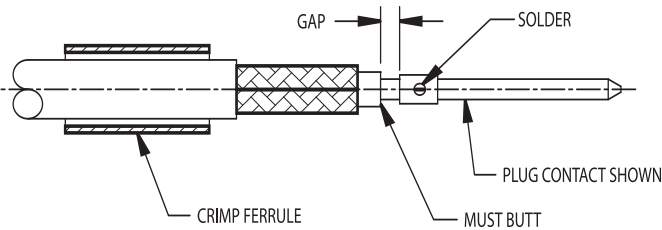


3. ASSEMBLE WEDGE ASSEMBLY TO BODY. SLIDE CLAMP NUT FORWARD AND CLAMP WEDGE TO BODY. TORQUE CLAMP NUT TP 8 IN.-LBS. SLIDE FERRULE FORWARD AND CRIMP. SLIDE SHRINK TUBING FORWARD AND HEAT SHRINK.

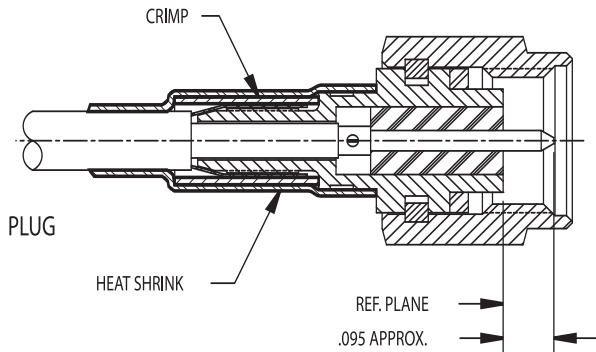
PART NUMBER	"A" DIM	"B" DIM	"C" DIM	GAP	FERRULE HEX SIZE	
250-900-0630	.250	.040	.110	.000	.128	
250-900-0631	.250	.040	.110	.000	.151	
250-900-1160	250-900-1161	.190	.000	.100	.000	.213
251-975-0630	.380	.160	.110	.015	.128	
251-975-0631	.380	.160	.110	.015	.151	
251-975-1160	251-975-1161	.300	.110	.100	.000	.213
350-900-0630	.270	.060	.110	.000	.128	
350-900-0631	.270	.060	.110	.000	.151	
350-900-1160	350-900-1161	.218	.000	.090	.000	.213
351-900-0630	.320	.110	.110	.019	.128	
351-900-0631	.320	.110	.110	.019	.151	
351-900-1160	351-900-1161	.302	.092	.125	.000	.213
351-975-0630	.270	.000	.140	.000	.128	
351-975-0631	.270	.000	.140	.000	.151	
351-975-1160	351-975-1161	.300	.110	.100	.000	.213



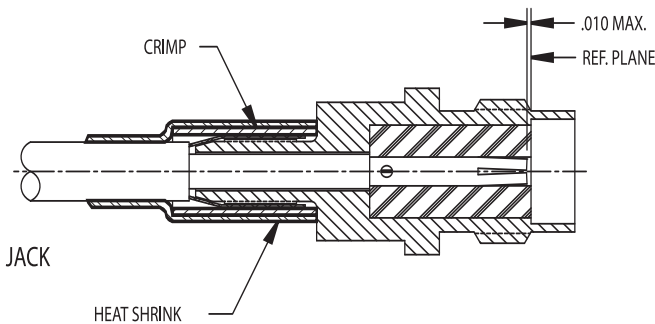
1. TRIM CABLE TO DIMENSIONS SHOWN. DO NOT NICK CENTER CONDUCTOR.



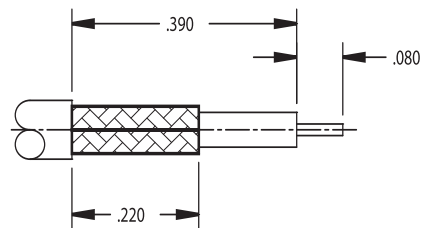
2. SLIDE FERRULE OVER CABLE. SOLDER CENTER CONTACT TO CENTER CONDUCTOR THROUGH HOLE IN CONTACT. CONTACT MUST BUTT AGAINST DIELECTRIC. CLEAN.



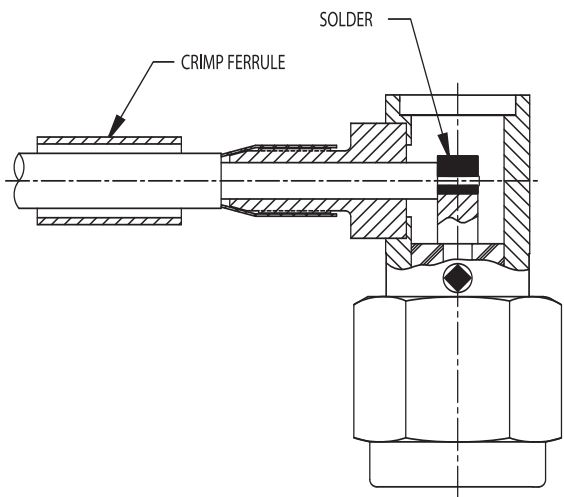
3. SLIDE FERRULE FORWARD OVER BRAID AND CRIMP. SHRINK SLEEVING OVER FERRULE AND CABLE.



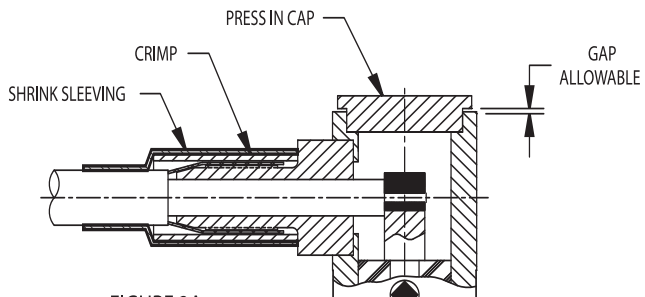
PART NUMBER		FIG.	FERRULE HEX SIZE
252-900-0630		3B	.128
252-900-0631		3B	.151
252-900-1160	252-900-1161	3B	.213
352-900-0630		3A	.128
352-900-0631		3A	.151
352-900-1160	352-900-1161	3A	.213



1. TRIM CABLE TO DIMENSIONS SHOWN. DO NOT NICK CENTER CONDUCTOR.



2. SLIDE FERRULE OVER CABLE. INSERT CABLE INTO WEDGE. CENTER CONDUCTOR MUST ENTER SLOT IN CENTER CONTACT. DIELECTRIC OF CABLE MUST BUTT AGAINST CONTACT. SOLDER CENTER CONDUCTOR INTO SLOT IN CONTACT. CLEAN.



3. SLIDE FERRULE FORWARD AND CRIMP. PRESS OR SOLDER CAP INTO BODY PER FIG. 1 OR 2. NOTE: WHEN PRESSING IN CAP, DO NOT SEAT ON COUPLING NUT.

FIGURE 3A

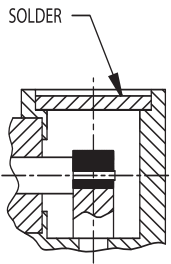
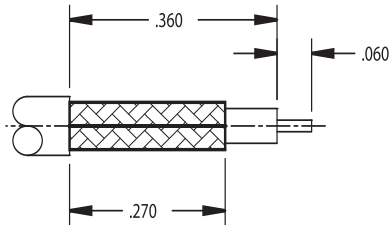


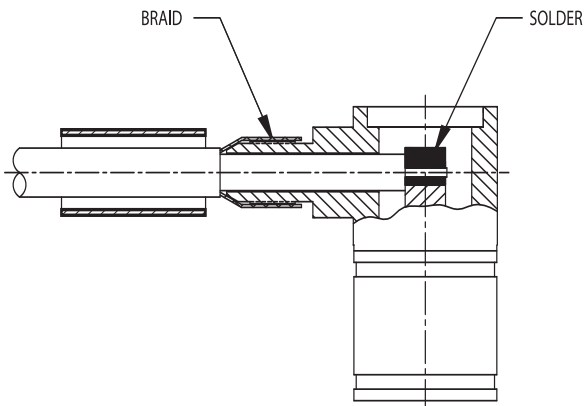
FIGURE 3B

4. SHRINK SLEEVING OVER FERRULE AND CABLE AS SHOWN.

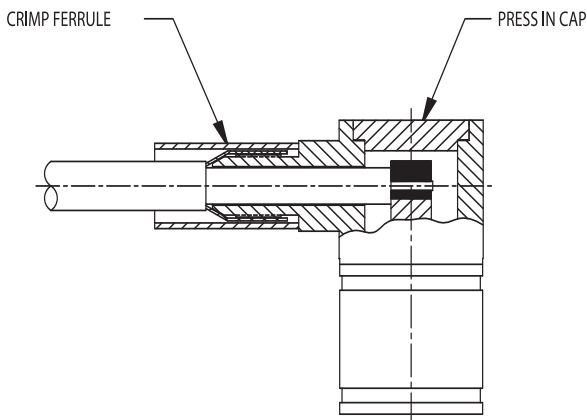
PART NUMBER	FERRULE HEX SIZE
512-900-0360	.105
512-900-0630	.128
512-900-0631	.151



1. TRIM CABLE TO DIMENSIONS SHOWN. DO NOT NICK CENTER CONDUCTOR.

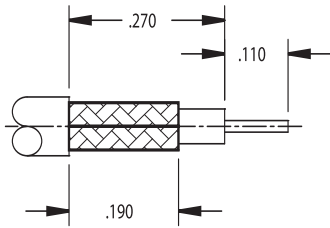


2. SLIDE FERRULE OVER CABLE. INSERT CABLE INTO WEDGE. CENTER CONDUCTOR MUST ENTER SLOT IN CENTER CONTACT. DIELECTRIC OF CABLE MUST BUTT AGAINST CONTACT. SOLDER CENTER CONDUCTOR INTO SLOT IN CONTACT. CLEAN.

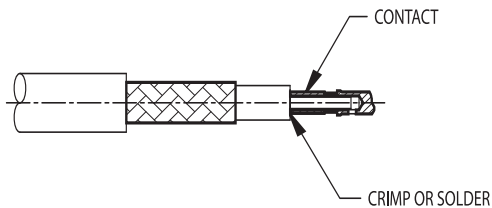


3. SLIDE FERRULE FORWARD AND CRIMP. PRESS CAP INTO BODY.

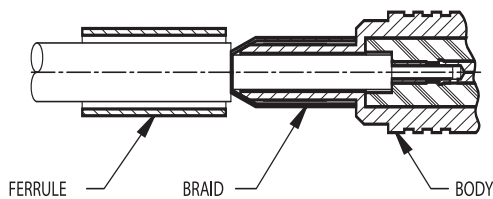
PART NUMBER	CRIMP TOOL (CENTER CONTACT)	POSITIONER	TOOL SETTING
450-900-SERIES	T 2400	P 0632	4
451-980-SERIES			



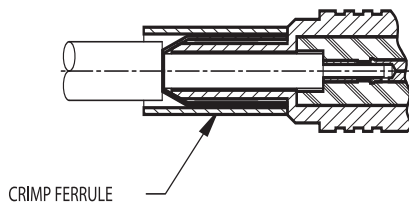
1. TRIM CABLE TO DIMENSIONS SHOWN. DO NOT NICK BRAIDS OR CENTER CONDUCTOR.



2. SLIDE FERRULE OVER BRAID. PLACE CENTER CONTACT INTO POSITIONER OF CRIMP TOOL (SEE TABLE FOR POSITIONER AND SETTING). INSERT CABLE CENTER CONDUCTOR INTO AND CRIMP. DIELECTRIC OF CABLE MUST BUTT AGAINST SHOULDER OF CONTACT. (NOTE: CENTER CONTACT MAY BE SOLDERED TO CENTER CONDUCTOR).



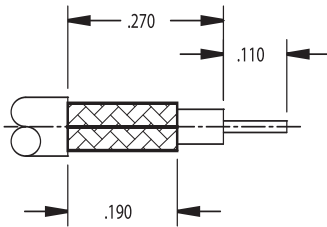
3. FLAIR BRAID. INSERT CENTER CONTACT INTO BODY UNTIL IT SNAPS INTO INSULATOR. BRAID WILL SIT OVER BARREL PORTION OF BODY.



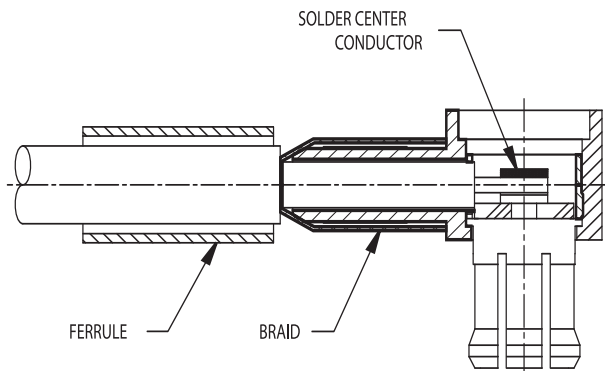
4. SLIDE FERRULE FORWARD OVER BRAID AND CRIMP WITH APPROPRIATE HEX CRIMP DIE.



PART NUMBER	FERRULE HEX SIZE
452-900-0360	.105
452-900-0630	.128
452-900-0631	.151

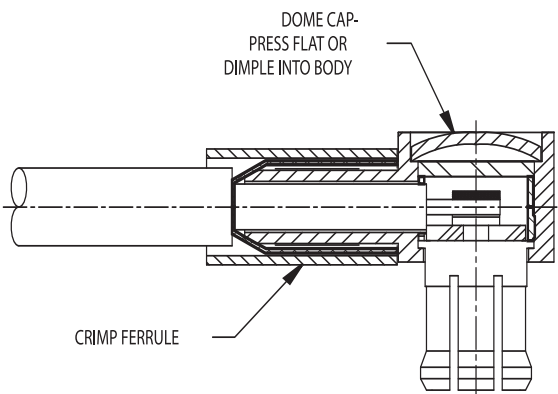


1. TRIM CABLE TO DIMENSIONS SHOWN. DO NOT NICK BRAIDS OR CENTER CONDUCTOR.



2. SLIDE FERRULE OVER BRAID. FLAIR BRAID AND INSERT INTO BODY. CENTER CONDUCTOR MUST ENTER SLOT IN CONTACT. SOLDER CONTACT. CLEAN.

3. SLIDE FERRULE FORWARD OVER BRAID AND CRIMP WITH APPROPRIATE HEX CRIMP DIE.



4. PLACE INSULATOR INTO ACCESS HOLE OVER CENTER CONTACT.

PART NUMBER		DIM A	DIM B	DIM C	HEX SIZE
360-900-0630	360-974-0630	.200 [5.1]	.220 [5.6]	.100 [2.5]	.128 [3.25]
361-922-0630		.200 [5.1]	.220 [5.6]	.100 [2.5]	.128 [3.25]

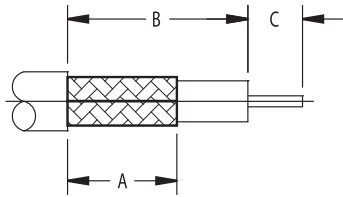


FIGURE 1

1. TRIM CABLE TO DIMENSIONS SHOWN. DO NOT NICK BRAID OR CENTER CONDUCTOR. (SEE FIG. 1)

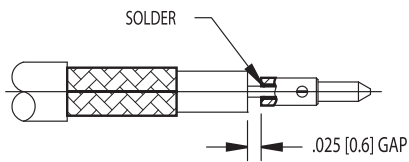


FIGURE 2

2. SLIDE CENTER CONDUCTOR OF CABLE INTO REAR CONTACT. SET GAP BETWEEN CONTACT AND DIELECTRIC OF CABLE. SOLDER. CLEAN. (SEE FIG. 2)

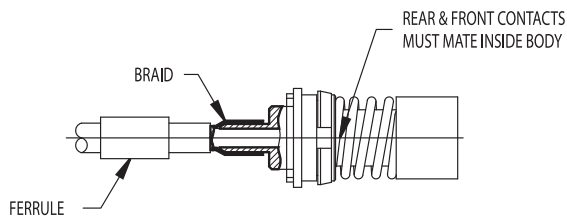


FIGURE 3

3. SLIDE FERRULE ONTO CABLE. FLAIR BRAID. INSERT CABLE INTO BODY, ALLOWING BRAID TO SLIDE OVER OUTSIDE OF BODY. INSERT CABLE UNTIL DIELECTRIC BUTTS AGAINST INSULATOR INSIDE BODY. REAR CONTACT MUST ENGAGE WITH FRONT CONTACT INSIDE BODY. (SEE FIG. 3)

4. SLIDE FERRULE FORWARD OVER BRAID, UP TO SHOULDER AND CRIMP.

PART NUMBER	DIM A	DIM B	DIM C	HEX SIZE
362-974-0630	.200 [5.1]	.310 [7.9]	.100 [2.5]	.128 [3.25]
363-922-0630	.200 [5.1]	.330 [8.4]	.100 [2.5]	.128 [3.25]

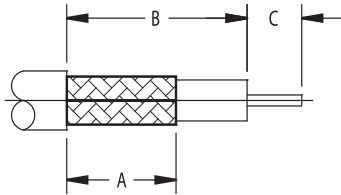


FIGURE 1

1. TRIM CABLE TO DIMENSIONS SHOWN. DO NOT NICK BRAID OR CENTER CONDUCTOR. (SEE FIG. 1)

2. SLIDE FERRULE ONTO CABLE. FLAIR BRAID. INSERT CABLE INTO BODY, ALLOWING BRAID TO SLIDE OVER OUTSIDE OF BODY. CENTER CONDUCTOR MUST ENTER SLOT IN CENTER CONTACT. SOLDER CENTER CONDUCTOR TO CONTACT. CLEAN. (SEE FIG. 2)

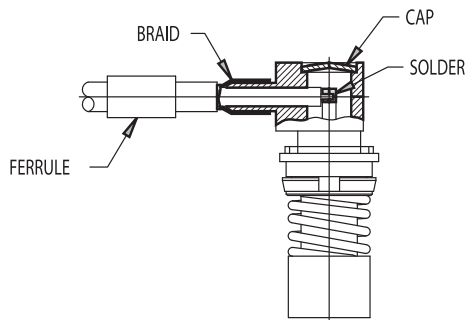
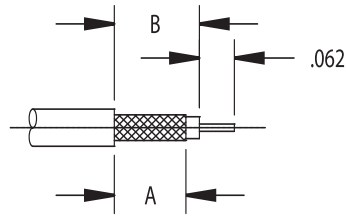


FIGURE 2

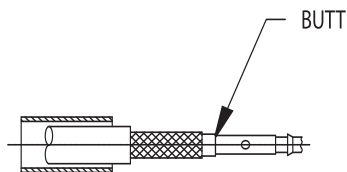
3. SLIDE FERRULE FORWARD OVER BRAID, UP TO SHOULDER AND CRIMP.

4. PLACE CAP INTO BODY AS SHOWN AND DEPRESS CAP TO EXPAND INSIDE COUNTERBORE OF BODY. (SEE FIG. 2)

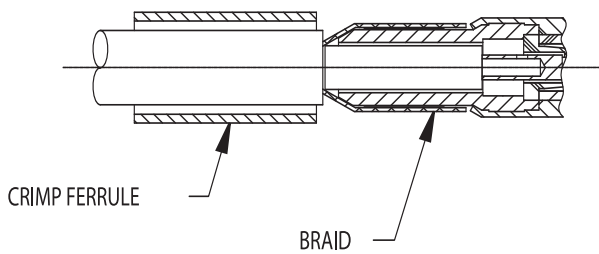
PART NUMBER		A	B	FERRULE HEX SIZE
470-900-0360	471-900-0360	.190	.225	.105
470-900-0630	471-900-0630	.190	.225	.128



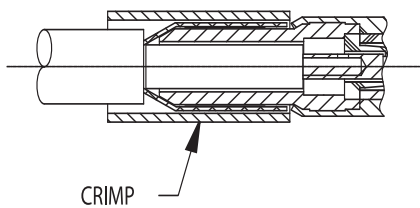
1. Trim cable to dimensions shown. Do not nick center conductor.



2. Slide ferrule over jacket. Insert center conductor of cable into contact. Dielectric of cable must butt against contact. Solder contact to center conductor. Clean.

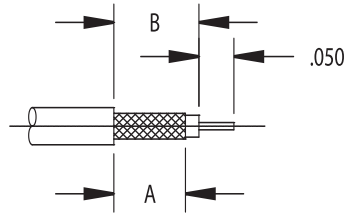


3. Flair braid. Insert center contact into body until it snaps into insulator.

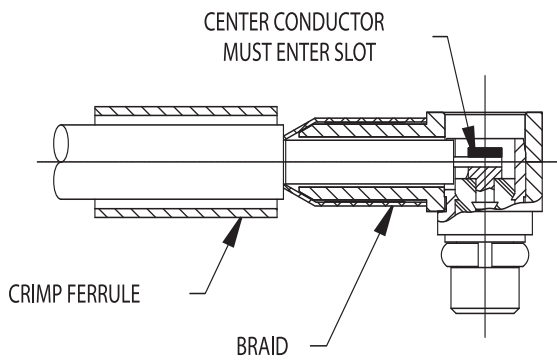


4. Slide ferrule over braid up to the shoulder of body. Crimp ferrule to retain braid. See table for hex sizes.

PART NUMBER	A	B	FERRULE HEX SIZE
472-900-0360	.190	.225	.105
472-900-0630	.190	.225	.128

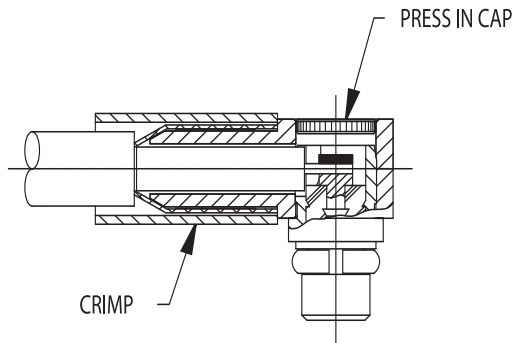


1. Trim cable to dimensions shown. Tin the center conductor.

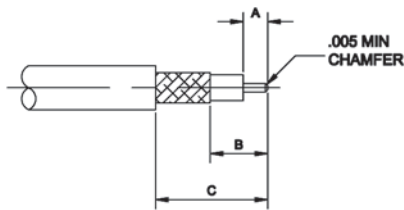


2. Slide ferrule over jacket. Flair braid. Insert cable into body. Center conductor must enter slot in contact. Solder contact. Clean.

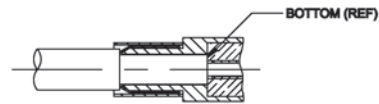
3. Slide ferrule over braid up to the shoulder of body. Crimp ferrule to retain braid. See table for hex sizes.



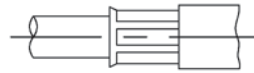
4. Press cap into body.



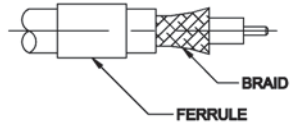
1. STRIP CABLE TO DIMENSIONS AS SHOWN.



3. SLIDE CABLE INTO BODY, CENTER CONDUCTOR TO ENTER PREASSEMBLED SOCKET CONTACT, UNTIL CABLE DIELECTRIC BOTTOMS AGAINST INSULATOR. SLIDE FERRULE OVER BRAID UP TO THE SHOULDER OF BODY.



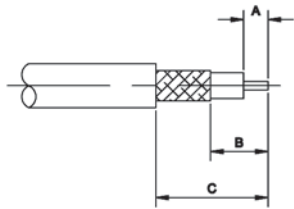
4. CRIMP THE FERRULE WITH HEX DIE.



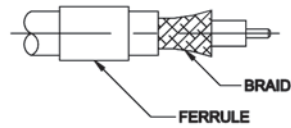
2. SLIDE FERRULE OVER JACKET. FLARE BRAID.

STRIP AND HEX DIE CHART:

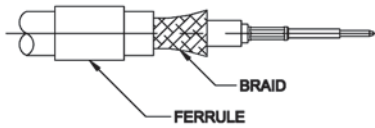
PART NUMBER	A	B	C	HEX DIE
0345-E00-28C01	.155	.312	.624	.192
0345-E00-C7201				.178



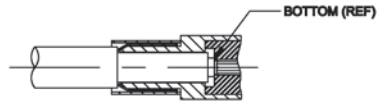
1. STRIP CABLE TO DIMENSIONS AS SHOWN.



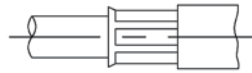
2. SLIDE FERRULE OVER JACKET. FLARE BRAID.



3. CRIMP (OR SOLDER) CONTACT TO CABLE USING A .042" HEX DIE.



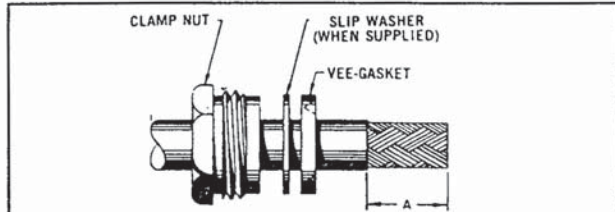
4. SLIDE CABLE INTO BODY UNTIL CABLE DIELECTRIC BOTTOMS AGAINST INSULATOR. SLIDE FERRULE OVER BRAID UP TO THE SHOULDER OF BODY.



5. CRIMP THE FERRULE WITH HEX DIE.

STRIP AND HEX DIE CHART:

PART NUMBER	A	B	C	HEX DIE
0345-E00-C7202	.150	.327	.625	.042
				.178



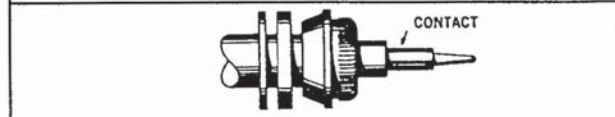
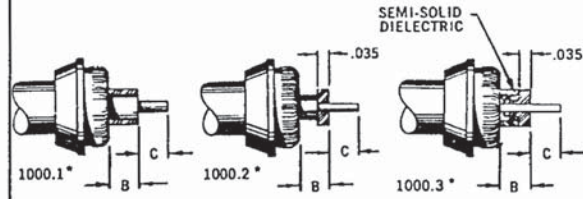
1. Cut cable end square, place clamp-nut, slip washer (when supplied), and gasket over jacket. Remove jacket to dimension "A."



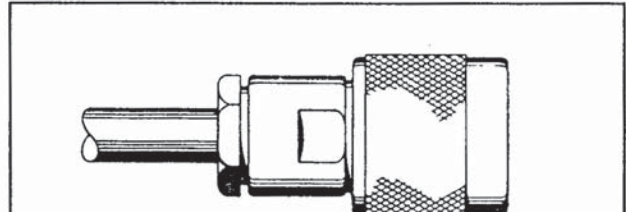
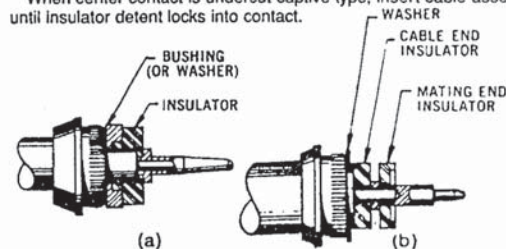
2. Comb out braid and taper forward. Place braid clamp over braid against jacket cut.



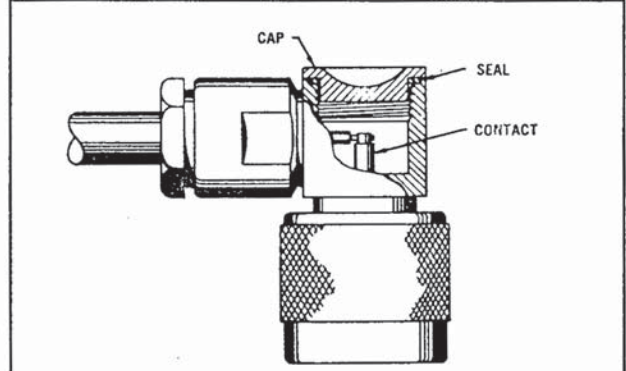
3. Fold braid back over braid clamp and trim as shown above. Remove dielectric to dimension "B." Cut center conductor to dimension "C."  
When cable positioning insulators are used adjust trim code dimensions as shown below, and assemble as indicated.



4. Solder contact to center conductor. For access type angle connectors, omit this step and proceed to step 5.  
For captive contacts: (a) assemble bushing and insulator, attach contact, or (b) assemble washer and larger (cable end) insulator. Attach contact. Assemble smaller (mating end) insulator.  
When center contact is undercut captive type, insert cable assembly until insulator detent locks into contact.



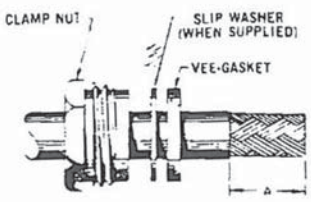
5. Thread assembly into connector, and lock securely. Vee gasket must be split by braid clamp.



6. For access type angle connectors, solder center conductor in contact groove. Close access opening.


TRIM CODE CHART			
CODE	A	B	C
1001	11/16	.440	7/64
1002	23/32	.470	7/64
1003	11/16	.420	1/8
1004	11/32	.106	7/64
1005	11/32	.040	5/32
1008	3/8	.180	1/16
1012	13/32	.128	5/32
1013	7/16	.170	5/32
1014	7/16	.118	7/32
1015	3/8	.118	5/32
1016	3/8	.046	7/32
1017	13/32	.074	3/16
1018	31/64	.065	7/32
1019	5/8	.371	5/32
1021	3/8	.096	5/32
1022	5/16	.046	5/32
1024	3/8	.046	3/16
1025	13/32	.216	3/32
1030	1/4	.045	3/32
1031	5/8	.296	7/32
1033	19/32	.327	5/32
1042	5/16	.070	1/8
1044	5/16	.105	9/64
1050	19/64	.109	7/64






CLAMP NUT  
SLIP WASHER (WHEN SUPPLIED)  
VEE-GASKET

**1.** Cut cable end square, place clamp-nut, slip washer (when supplied), and gasket over jacket. Remove jacket to dimension "A."

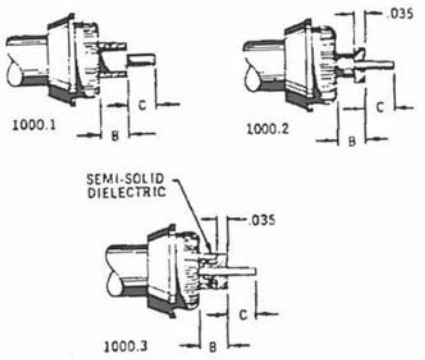


BRAID CLAMP

**2.** Comb out braid and taper forward. Place braid clamp over braid against jacket cut.




**3.** Fold braid back over braid clamp and trim as shown above. Remove dielectric to dimension "B." Cut center conductor to dimension "C."  
When cable positioning insulators are used adjust trim code dimensions as shown below, and assemble as indicated.



1000.1      1000.2      .035

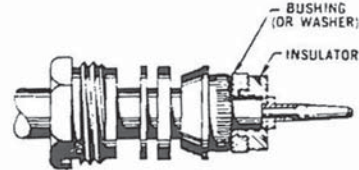
1000.3      .035

SEMI-SOLID DIELECTRIC

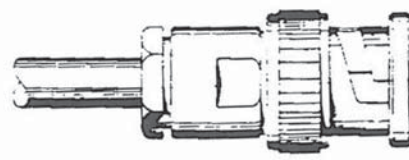


CONTACT

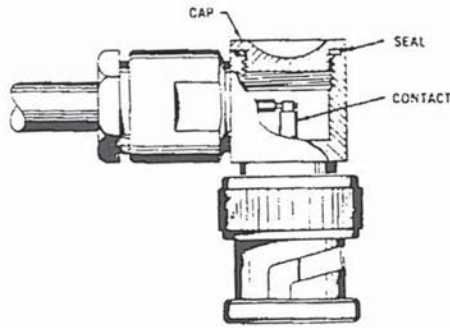
**4.** Solder or crimp contact to center conductor. For access type angle connectors, omit this step and proceed to step 5. For captive contacts, assemble contact capturing parts on cable before attaching contact as shown below.



BUSHING (OR WASHER)  
INSULATOR



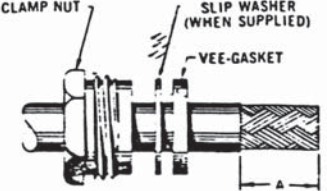
**5.** Thread assembly into connector, and lock securely. Vee gasket must be split by braid clamp.




CAP  
SEAL  
CONTACT

**6.** For access type angle connectors, solder center conductor in contact groove. Close access opening.


TRIM CODE CHART			
CODE	A	B	C
1006	3/4	.531	7/64



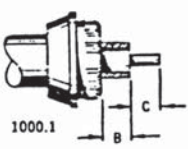
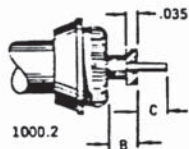
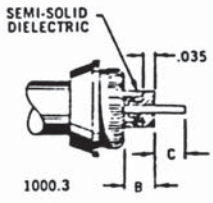

**1.** Cut cable end square, place clamp-nut, slip washer (when supplied), and gasket over jacket. Remove jacket to dimension "A."



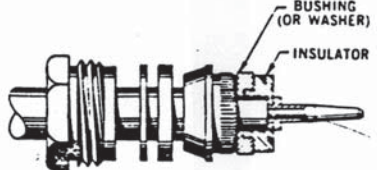
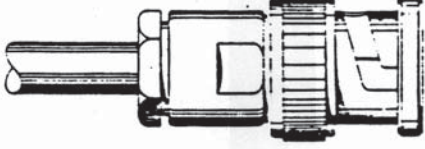
**2.** Comb out braid and taper forward. Place braid clamp over braid against jacket cut.



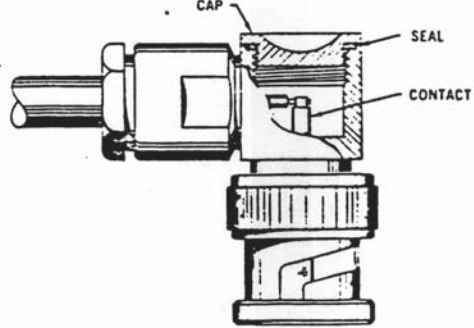
**3.** Fold braid back over braid clamp and trim as shown above. Remove dielectric to dimension "B." Cut center conductor to dimension "C."  
When cable positioning insulators are used adjust trim code dimensions as shown below, and assemble as indicated.

**4.** Solder or crimp contact to center conductor. For access type angle connectors, omit this step and proceed to step 5. For captive contacts, assemble contact capturing parts on cable before attaching contact as shown below.

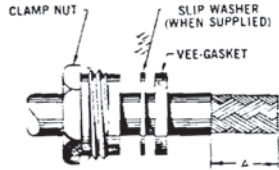



**5.** Thread assembly into connector, and lock securely. Vee gasket must be split by braid clamp.



**6.** For access type angle connectors, solder center conductor in contact groove. Close access opening.

TRIM CODE CHART			
CODE	A	B	C
1040	3/8	.070	5/32



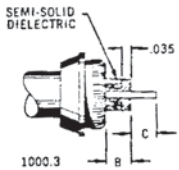
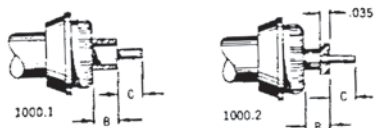
**1.** Cut cable end square, place clamp-nut, slip washer (when supplied), and gasket over jacket. Remove jacket to dimension "A."



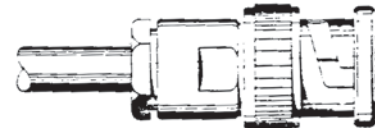
**2.** Comb out braid and taper forward. Place braid clamp over braid against jacket cut.



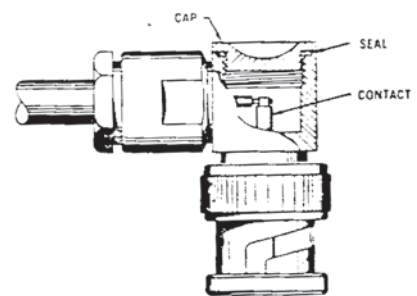
**3.** Fold braid back over braid clamp and trim as shown above. Remove dielectric to dimension "B." Cut center conductor to dimension "C."  
When cable positioning insulators are used adjust trim code dimensions as shown below, and assemble as indicated.



**4.** Solder or crimp contact to center conductor.  
For access type angle connectors, omit this step and proceed to step 5.  
For captive contacts, assemble contact capturing parts on cable before attaching contact as shown below.

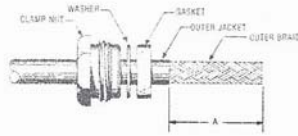


**5.** Thread assembly into connector, and lock securely. Vee gasket must be split by braid clamp.

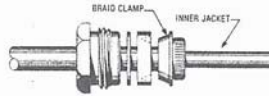


**6.** For access type angle connectors, solder center conductor in contact groove. Close access opening.

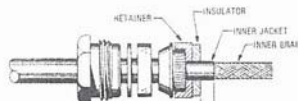
TRIM CODE CHART			
CODE	A	B	C
1052	1/2	.140	7/32



1. Cut cable end square. Slide clamp nut, washer and gasket over jacket. Remove outer jacket to dimension "A."



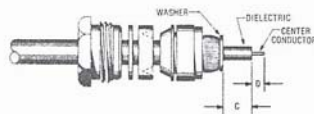
2. Place braid clamp over outer braid and against jacket cut. Comb out braid and fold back over braid clamp. Trim as shown.



3. Assemble retainer and insulator over inner jacket. Remove inner jacket to dimension "B."



4. Place braid clamp over inner braid and against inner jacket cut. Comb out braid and fold back over braid clamp. Trim even with base of braid clamp.



5. Place washer over dielectric against braid. Trim dielectric to dimension "C" and center conductor to dimension "D."



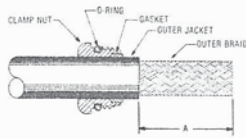
6. Solder center contact to center conductor.



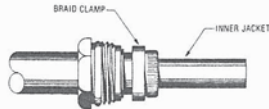
7. Assemble inner insulator, contact and outer insulator, then insert into body. Slide back end parts forward. Thread assembly into connector body and lock securely.

TRIM CODE CHART				
CODE	A	B	C	D
1301	.69	.096	.210	.094
1302	.69	.125	.214	.080
1303	.69	.096	.166	.141

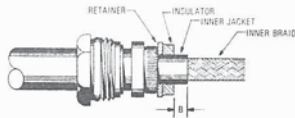




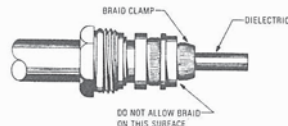
**1.** Cut cable end square. Assemble O-ring. Slide clamp nut and gasket over jacket. Remove outer jacket to dimension "A."



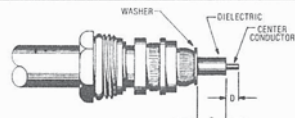
**2.** Place braid clamp over outer braid and against jacket cut. Comb out braid and fold back over braid clamp. Trim as shown.



**3.** Assemble retainer and insulator over inner jacket. Remove inner jacket to dimension "B."



**4.** Place braid clamp over inner braid and against inner jacket cut. Comb out braid and fold back over braid clamp. Trim even with base of braid clamp.



**5.** Place washer over dielectric against braid. Trim dielectric to dimension "C" and center conductor to dimension "D."



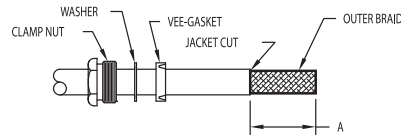
**6.** Solder center contact to center conductor.



**7.** Assemble inner insulator, contact and outer insulator, then insert into body. Slide back end parts forward. Thread assembly into connector body and lock securely.

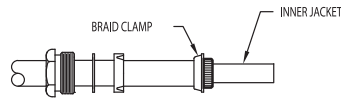
**TRIM CODE CHART**

CODE	A	B	C	D
1301A	11/16	.096	.210	3/32

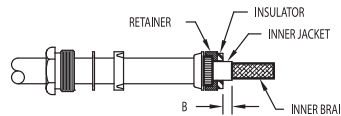


1. CUT CABLE END SQUARE, SLIDE CLAMP NUT, WASHER AND VEE-GASKET OVER JACKET. REMOVE OUTER JACKET TO DIMENSION "A".

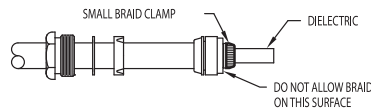
TRIM CODE CHART			
A	B	C	D
.69	.096	.102	.094



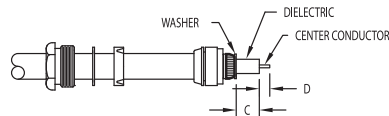
2. PLACE BRAID CLAMP OVER OUTER BRAID AND AGAINST JACKET CUT. COMB OUT BRAID AND FOLD BACK OVER BRAID CLAMP. TRIM AS SHOWN.



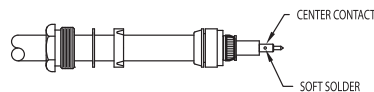
3. ASSEMBLE RETAINER AND INSULATOR OVER INNER JACKET. REMOVE INNER JACKET TO DIMENSION "B".



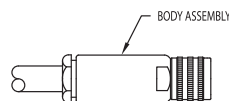
4. PLACE SMALL BRAID CLAMP OVER INNER BRAID AND AGAINST INNER JACKET CUT. COMB OUT BRAID AND FOLD BACK OVER SMALL CLAMP. TRIM EVEN WITH BASE OF BRAID CLAMP.



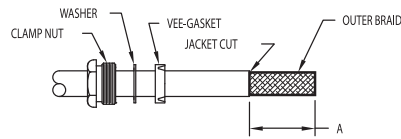
5. PLACE WASHER OVER DIELECTRIC AND AGAINST BRAID. TRIM DIELECTRIC TO DIMENSION "C" AND CENTER CONDUCTOR TO DIMENSION "D".



6. SOLDER CENTER CONTACT TO CENTER CONDUCTOR.

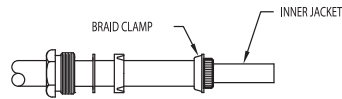


7. SLIDE BACK END PARTS FORWARD. ASSEMBLE INNER INSULATOR, INTERMEDIATE CONTACT AND OUTER INSULATOR. THREAD INTO CONNECTOR BODY AND TORQUE TO 30-35 IN.LBS.

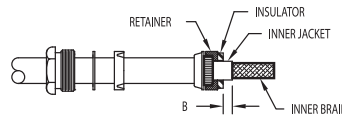


1. CUT CABLE END SQUARE, SLIDE CLAMP NUT, WASHER AND VEE-GASKET OVER JACKET. REMOVE OUTER JACKET TO DIMENSION "A".

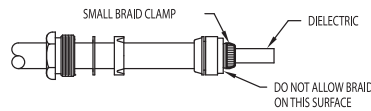
TRIM CODE CHART			
A	B	C	D
.69	.096	.243	.110



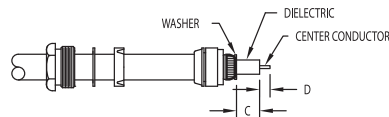
2. PLACE BRAID CLAMP OVER OUTER BRAID AND AGAINST JACKET CUT. COMB OUT BRAID AND FOLD BACK OVER BRAID CLAMP. TRIM AS SHOWN.



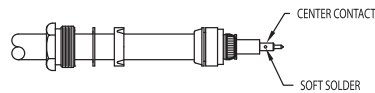
3. ASSEMBLE RETAINER AND INSULATOR OVER INNER JACKET. REMOVE INNER JACKET TO DIMENSION "B".



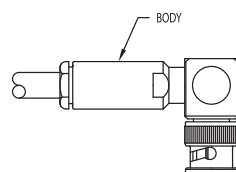
4. PLACE SMALL BRAID CLAMP OVER INNER BRAID AND AGAINST INNER JACKET CUT. COMB OUT BRAID AND FOLD BACK OVER SMALL CLAMP. TRIM EVEN WITH BASE OF BRAID CLAMP.



5. PLACE WASHER OVER DIELECTRIC AND AGAINST BRAID. TRIM DIELECTRIC TO DIMENSION "C" AND CENTER CONDUCTOR TO DIMENSION "D".



6. SOLDER CENTER CONTACT TO CENTER CONDUCTOR.



7. SLIDE BACK END PARTS FORWARD THREAD ASSEMBLY INTO CONNECTOR BODY AND TORQUE TO 35 IN LBS.

**1.** Cut cable end square. Slide cap over armor braid. Remove armor to dimension "A" and bulge back approximately 4".

**2.** Place clamp-nut, slip washer (when supplied), and gasket over jacket. Remove jacket to dimension "B."

**3.** Comb out braid and taper forward. Place braid clamp over braid against jacket cut.

**4.** Fold braid back over braid clamp and trim as shown above. Remove dielectric to dimension "C." Cut center conductor to dimension "D."

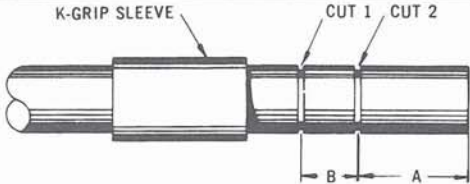
TRIM CODE CHART				
CODE	A	B	C	D
1601	1-5/32	3/8	.046	3/16
1606	1-1/8	9/32	.040	1/8
1607	1-3/32	1/4	.040	3/32
1608	1-5/32	3/8	.046	7/32

**5.** Solder contact to center conductor. For captive contacts, assemble contact capturing parts on cable before attaching contact as shown below.

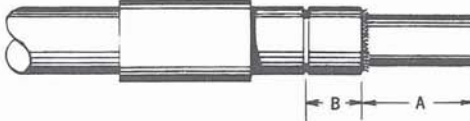
**6.** Thread assembly into connector, and lock securely. Vee gasket must be split by braid clamp.

**7.** Slide armor braid forward over tapered end of nut, and trim as shown. Tighten cap securely with wrench.

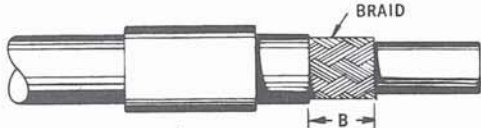




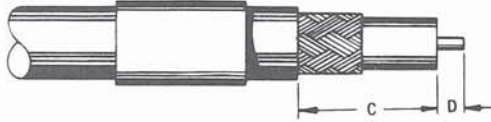
**1.** Cut cable end square, slide K-GRIP sleeve over jacket and make cuts 1 and 2 in jacket.



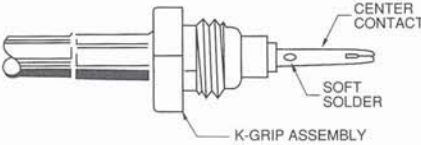
**2.** Remove jackets to dimension "A," flare or bulge back braid and trim with scissors at edge of jacket.



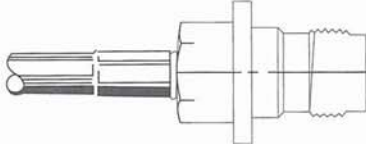
**3.** Remove jacket to dimension "B."



**4.** Using dielectric trim jig, trim dimension "C." Exposed center conductor length will be equal to dimension "D" of trim code.

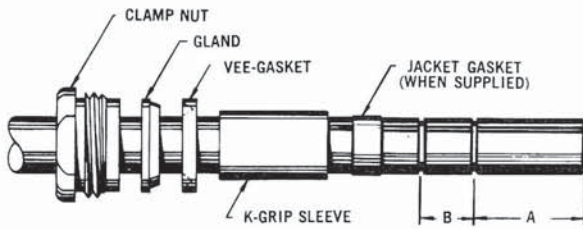


**5.** Push K-GRIP Jr. over dielectric and under braid until dielectric bottoms in connector. Slide K-GRIP sleeve against shoulder on body and form hex. Soft solder contact as shown.



**6.** Thread assembly into connector, and lock securely.

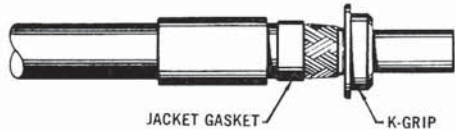
TRIM CODE CHART				
CODE	A	B	C	D
432	17/64	7/32	.390	3/32
439	7/32	7/32	.345	3/32
493	1/4	9/32	.390	.140
1901	.510	.220	.450	.280



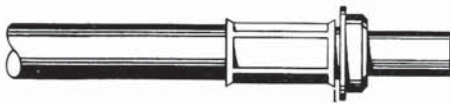
**1.** Cut cable end square, slide K-GRIP sleeve and back end parts over jacket. Make cuts A and B in jacket.



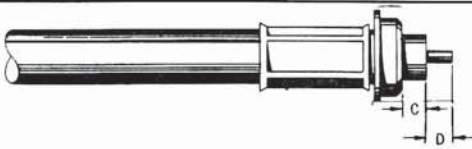
**2.** Remove jacket to dimension "A." Flare or bulge back braid. Trim with scissors at edge of jacket.



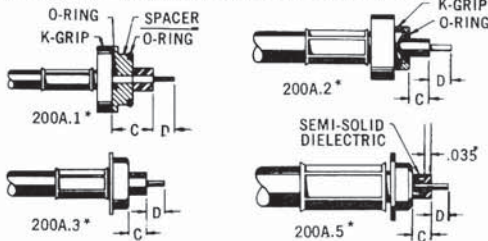
**3.** Remove jacket to dimension "B." Push K-GRIP over dielectric and under braid. Slide jacket gasket, when provided, forward to position flush with jacket edge. (When the "B" dimension in the trim code is 0, push the K-GRIP under both braid and jacket, butting braid against flange of K-GRIP. Teflon jackets may be slit axially 1/4" in the two places to facilitate entry of the K-GRIP.



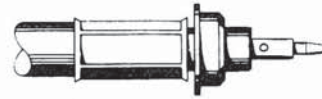
**4.** Slide K-GRIP sleeve against flange on K-GRIP Form hex.



**5.** Trim dielectric to dimension "C." Cut center conductor to dimension "D." Assemble internal O-ring seals and spacer, when provided, as shown below. When cable positioning insulators are used, adjust trim code dimensions as shown below, and assemble as indicated.

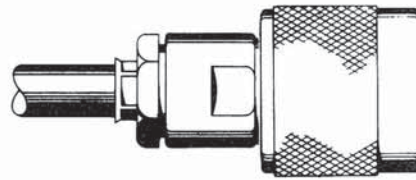
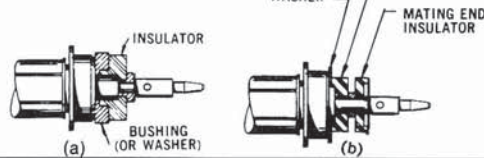


\*Use appropriate dimensions from trim code chart at right.

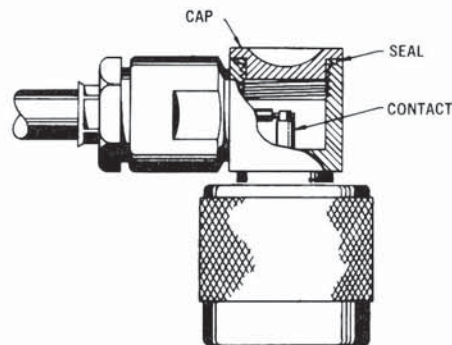


**6.** Solder or crimp contact to center conductor. For access type angle connectors, omit this step and proceed to step 7.

For captive contacts: (a) assemble bushing and insulator. Attach contact or (b) assemble washer and larger (cable end) insulator. Attach contact. Assemble smaller (mating end) insulator.



**7.** Thread assembly into connector and lock securely. Vee gasket must be split by braid clamp.



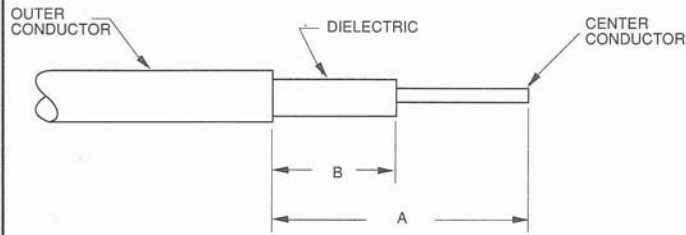
**8.** For access type angle connectors, solder center conductor in contact groove. Close access opening.

TRIM CODE CHART

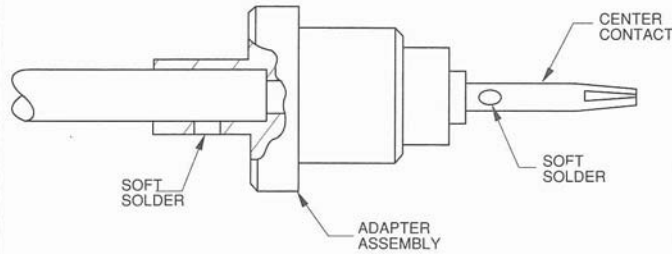
CODE	A	B	C	D
201A	1/2	7/32	.110	7/64
204A	5/8	7/32	.118	7/32
207A	9/16	7/32	.118	5/32
208A	29/32	7/32	.298	7/32
209A	19/32	7/32	.043	5/32
211A	35/64	7/32	.045	7/64
225A	3/8	0	.106	7/64
226A	9/16	3/16	.111	7/64
227A	45/64	3/16	.170	3/32
228A	37/64	3/16	.244	7/64
230A	19/32	7/32	.043	3/16
243A	9/32	0	.053	5/64

**1.** Cut cable end square and slide clamp nut onto outer conductor.

**2.** Remove outer conductor to dimension "A" and dielectric to dimension "B."



**3.** Insert cable into adapter assembly until bottomed. Soft solder outer conductor then center conductor as shown.



**4.** With connector body assembly mounted on bulkhead, insert cable assembly and lock securely with clamp nut.

**TRIM CODE CHART**

CODE	A	B
2101	3/8	.125

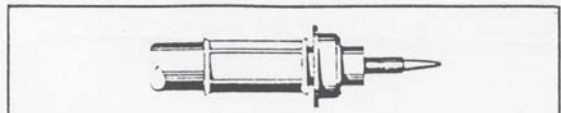
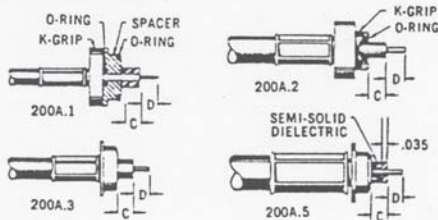
**1.** Cut cable end square, slide K-GRIP sleeve and back end parts over jacket. Using jacket trim jig, make cuts A and B in jacket.

**2.** Remove jacket to dimension "A." Flare or bulge back braid. Trim with scissors at edge of jacket.

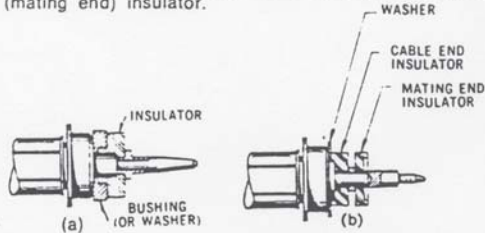
**3.** Remove jacket to dimension "B." Push K-GRIP over dielectric and under braid. Slide jacket gasket, when provided, forward to position flush with jacket edge. (When the "B" dimension in the trim code is 0, push the K-GRIP under both braid and jacket, butting braid against flange of K-GRIP. Teflon jackets may be slit axially 1/4" in the two places to facilitate entry of the K-GRIP.)

**4.** Slide K-GRIP sleeve against flange on K-GRIP. Form hex.

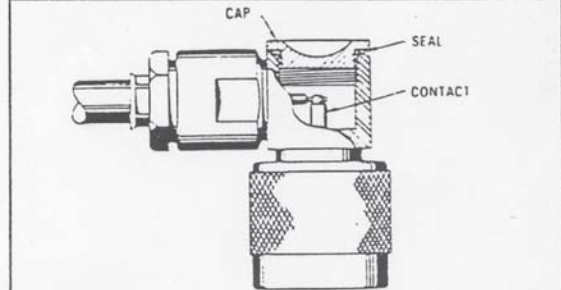
**5.** With dielectric trim jig, trim dielectric to dimension "C." Cut center conductor to dimension "D." Assemble internal O-ring seals and spacer, when provided, as shown below. When cable positioning insulators are used, adjust trim code dimensions as shown below, and assemble as indicated.



**6.** Solder or crimp contact to center conductor. For access type angle connectors, omit this step and proceed to step 7.  
For captive contacts: (a) assemble bushing and insulator. Attach contact or (b) assemble washer and larger (cable end) insulator. Attach contact. Assemble smaller (mating end) insulator.



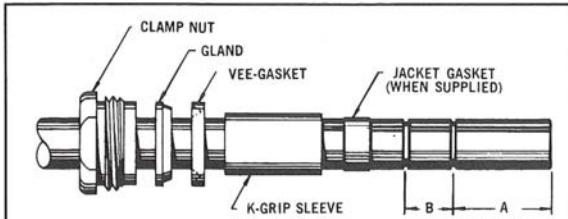
**7.** Thread assembly into connector and lock securely. Vee gasket must be split by braid clamp.



**8.** For access type angle connectors, solder center conductor in contact groove. Close access opening.

TRIM CODE CHART				
CODE	A	B	C	D
213A	21/32	7/32	.041	7/32

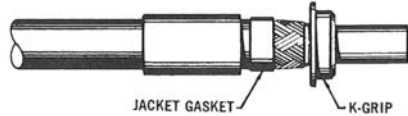




**1.** Cut cable end square, slide K-GRIP sleeve and back end parts over jacket. Make cuts A and B in jacket.



**2.** Remove jacket to dimension "A." Flare or bulge back braid. Trim with scissors at edge of jacket.



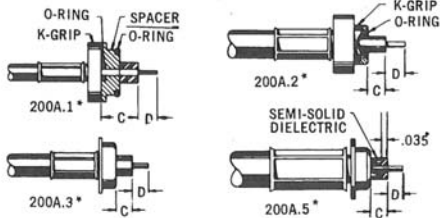
**3.** Remove jacket to dimension "B." Push K-GRIP over dielectric and under braid. Slide jacket gasket, when provided, forward to position flush with jacket edge. (When the "B" dimension in the trim code is 0, push the K-GRIP under both braid and jacket, butting braid against flange of K-GRIP. Teflon jackets may be slit axially 1/4" in the two places to facilitate entry of the K-GRIP.



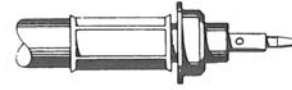
**4.** Slide K-GRIP sleeve against flange on K-GRIP Form hex.



**5.** Trim dielectric to dimension "C." Cut center conductor to dimension "D." Assemble internal O-ring seals and spacer, when provided, as shown below. When cable positioning insulators are used, adjust trim code dimensions as shown below, and assemble as indicated.

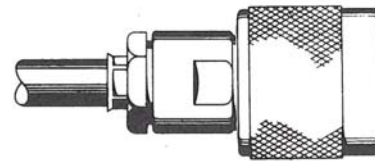
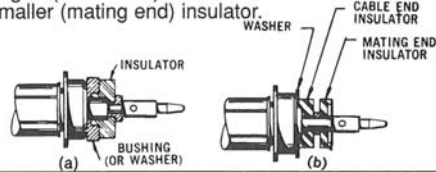


\*Use appropriate dimensions from trim code chart at right.

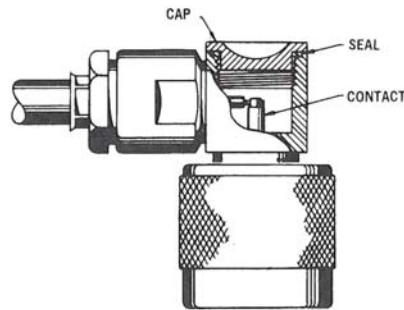


**6.** Solder or crimp contact to center conductor. For access type angle connectors, omit this step and proceed to step 7.

For captive contacts: (a) assemble bushing and insulator. Attach contact or (b) assemble washer and larger (cable end) insulator. Attach contact. Assemble smaller (mating end) insulator.



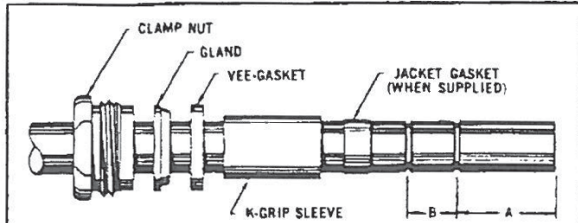
**7.** Thread assembly into connector and lock securely. Vee gasket must be split by braid clamp.



**8.** For access type angle connectors, solder center conductor in contact groove. Close access opening.

TRIM CODE CHART

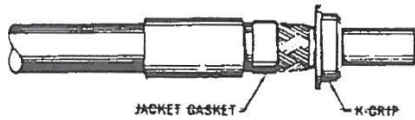
CODE	A	B	C	D
201A	1/2	7/32	.110	7/64
204A	5/8	7/32	.118	7/32
207A	9/16	7/32	.118	5/32
208A	29/32	7/32	.298	7/32
209A	19/32	7/32	.043	5/32
211A	35/64	7/32	.045	7/64
225A	3/8	0	.106	7/64
226A	9/16	3/16	.111	7/64
227A	45/64	3/16	.170	3/32
228A	37/64	3/16	.244	7/64
230A	19/32	7/32	.043	3/16
243A	9/32	0	.053	5/64



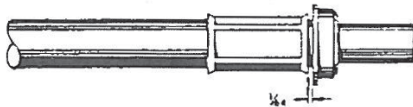
**1.** Cut cable end square, slide K-GRIP sleeve and back end parts over jacket. Using jacket trim jig, make cuts A and B in jacket.



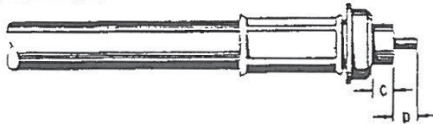
**2.** Remove jacket to dimension "A." Flare or bulge back braid. Trim with scissors at edge of jacket.



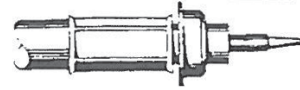
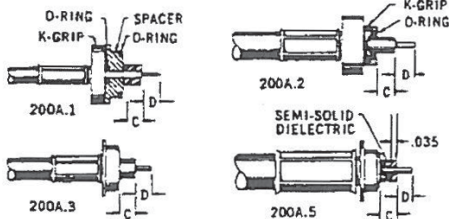
**3.** Remove jacket to dimension "B." Push K-GRIP over dielectric and under braid. Slide jacket gasket, when provided, forward to position flush with jacket edge. (When the "B" dimension in the trim code is 0, push the K-GRIP under both braid and jacket, butting braid against flange of K-GRIP. Teflon jackets may be slit axially 1/4" in the two places to facilitate entry of the K-GRIP.)



**4.** Slide K-GRIP sleeve against flange on K-GRIP. Form hex.

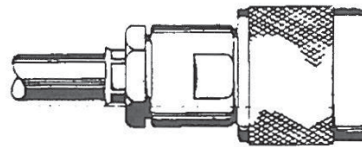
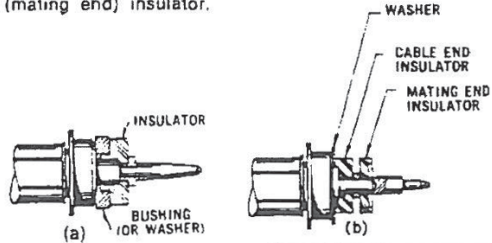


**5.** With dielectric trim jig, trim dielectric to dimension "C." Cut center conductor to dimension "D." Assemble internal O-ring seals and spacer, when provided, as shown below. When cable positioning insulators are used, adjust trim code dimensions as shown below, and assemble as indicated.

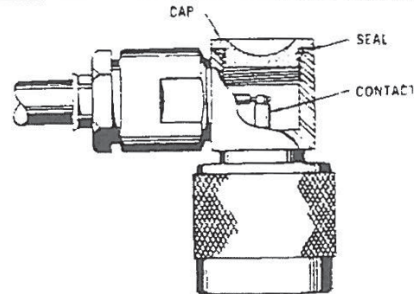


**6.** Solder or crimp contact to center conductor. For access type angle connectors, omit this step and proceed to step 7.

For captive contacts: (a) assemble bushing and insulator. Attach contact or (b) assemble washer and larger (cable end) insulator. Attach contact. Assemble smaller (mating end) insulator.



**7.** Thread assembly into connector and lock securely. Vee gasket must be split by braid clamp.



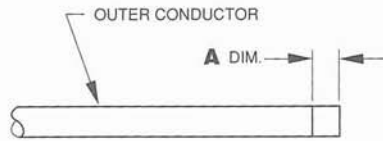
**8.** For access type angle connectors, solder center conductor in contact groove. Close access opening.

TRIM CODE CHART

CODE	A	B	C	D
239A	29/32	7/32	.294	9/32

**CP-3800**

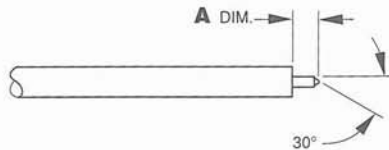
**1.** Trim cable using indicated trim tool.



**A.** Cut cable end square and score outer conductor all around to dimension indicated.



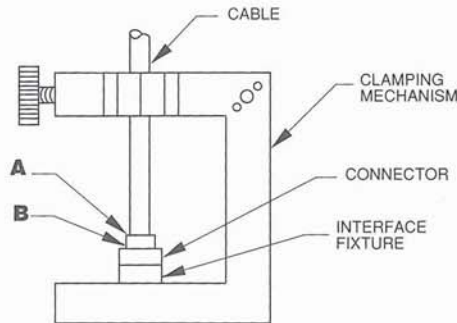
**B.** Remove jacket to scored mark with pliers. Then remove dielectric to front face of outer conductor making sure surface is square and free of burrs. Do not nick center conductor.



**C.** File end of center conductor as shown, to approximately 30°.

**2.** Insert trimmed end of cable into back end of connector, until cable bottoms.

**3.** Put an interface fixture on the mating end to prevent movement of the interface while soldering.



**4.** Place cable, connector and interface fixture in a non-destructive clamping mechanism.

**5.** Set fixture in vertical position shown.

**6.** Apply a small amount of liquid rosin flux to cable/connector joint (point A).

**7.** Apply heat at point B using resistance type heat tweezers or other similar device that will not leave burn marks or solder residue on the connector body.

**8.** Apply solder at point A, forming a smooth continuous joint free of voids.

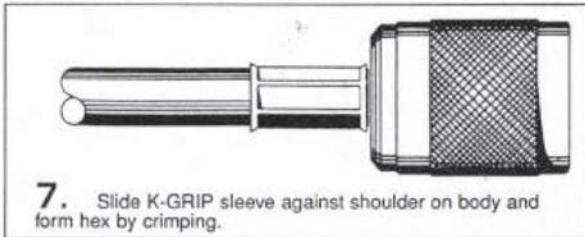
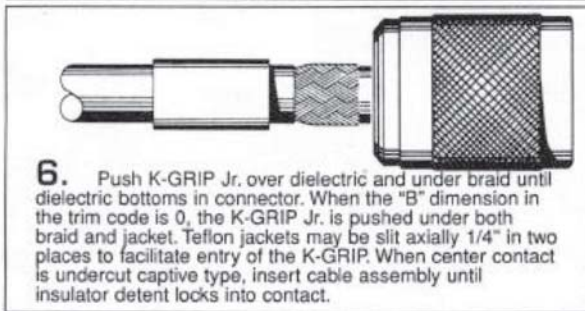
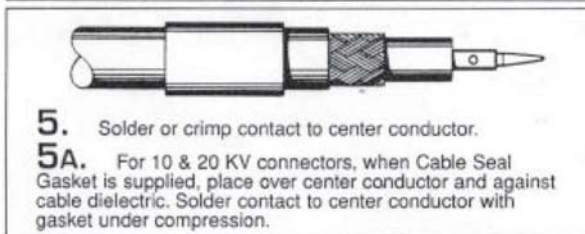
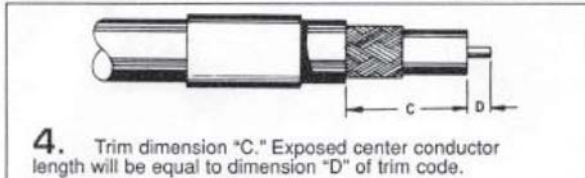
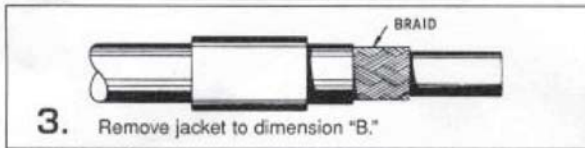
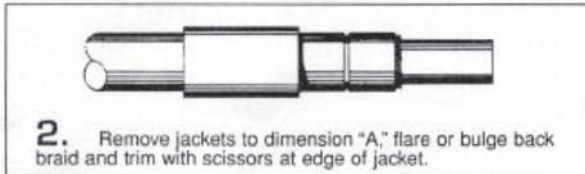
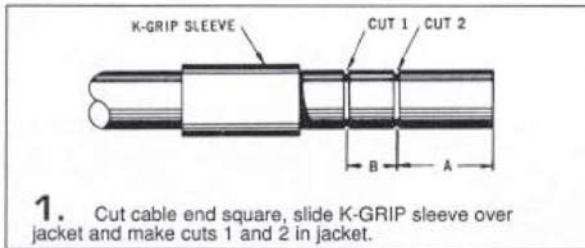
**9.** Allow to cool.

**10.** Clean off excess flux using alcohol or a freon based flux cleaner.

**TRIM CODE CHART**

CODE	A DIM.	TRIM TOOL
3800-1	.090/.080	KTO-2A
3800-2	.075/.065	KTO-3A





TRIM CODE CHART				
CODE	A	B	C	D
401	23/64	7/32	.468	7/64
402	11/32	7/32	.375	3/16
403	7/16	7/32	.493	5/32
405	49/64	7/32	.871	7/64
406	9/32	0	.093	3/16
407	11/16	0	.496	3/16
408	45/64	7/32	.809	7/64
409	19/64	3/16	.406	7/64
410	31/32	7/32	.562	5/8
413	21/32	7/32	.717	5/32
414	29/64	7/32	.556	7/64
415	15/32	3/16	.530	5/32
417	41/64	7/32	.743	7/64
418	45/64	7/32	.809	7/64
419	7/8	7/32	.984	7/64
421	15/64	0	.150	5/64
424	11/32	7/32	.450	7/64
426	17/64	7/32	.406	5/64
430	1/2	0	.211	1/4
431	9/16	0	.366	3/16
432	17/64	7/32	.390	3/32
433	5/16	7/32	.375	5/32
435	25/64	7/32	.524	5/64
436	35/64	7/32	.512	1/4
439	7/32	7/32	.345	3/32
440	11/32	7/32	.480	5/64
441	23/32	7/32	.772	5/32
447	1-1/64	7/32	.953	9/32
451	1-5/64	7/32	1.018	9/32
452	1-3/32	7/32	.690	5/8
457	45/64	7/32	.764	5/32
458	5/8	7/32	.671	11/64
459	39/64	7/32	.638	3/16
462	5/16	7/32	.437	3/32
464	15/32	7/32	.493	3/16
465	1/4	11/32	.432	5/32
468	25/64	7/32	.501	3/32
469	1/2	7/32	.580	9/64
470	13/32	7/32	.462	5/32
474	15/16	3/16	.890	15/64
475	1-3/4	3/16	1.627	5/16
477	19/64	9/32	.468	7/64
480	.281	.406	.500	.187
484	1-13/64	7/32	.948	15/64
487	27/64	7/32	.550	3/32
488	45/64	7/32	.316	39/64
489	11/32	11/32	.500	3/16
493	1/4	9/32	.390	.140
498	23/64	7/32	.316	17/64
5401	5/16	9/32	.432	5/32
5402	3/8	5/16	.500	3/16
5403	5/8	5/16	.750	3/16
5406	13/32	9/32	.500	3/16
5407	5/16	1/4	.437	1/8
5416	3/4	0	.560	3/16
5417	19/32	1/4	.703	9/64
5425	5/16	0	.187	1/8
5457	5/16	5/16	15/32	5/32





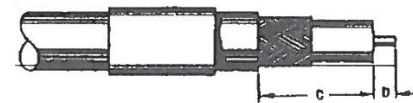
**1.** Cut cable end square, slide K-GRIP sleeve over jacket and with jacket trim jig make cuts 1 and 2 in jacket



**2.** Remove jackets to dimension "A," flare or bulge back braid and trim with scissors at edge of jacket.



**3.** Remove jacket to dimension "B."

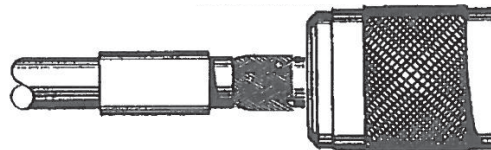


**4.** Using dielectric trim jig, trim dimension "C." Exposed center conductor length will be equal to dimension "D" of trim code.

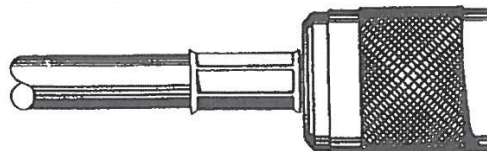


**5.** Solder or crimp contact to center conductor.

**5A.** For 10 & 20 KV connectors, when Cable Seal Gasket is supplied, place over center conductor and against cable dielectric. Solder contact to center conductor with gasket under compression.



**6.** Push K-GRIP Jr. over dielectric and under braid until dielectric bottoms in connector. When the "B" dimension in the trim code is 0, the K-GRIP Jr. is pushed under both braid and jacket. Teflon jackets may be slit axially 1/4" in two places to facilitate entry of the K-GRIP. When center contact is undercut captive type, insert cable assembly until insulator detent locks into contact.



**7.** Slide K-GRIP sleeve against shoulder on body and form hex by crimping.

TRIM CODE CHART				
CODE	A	B	C	D
412	5/8	7/32	.680	5/32



**1.** Cut cable end square, slide K-GRIP sleeve over jacket and with jacket trim jig make cuts 1 and 2 in jacket.



**2.** Remove jacket to dimension "A," flare or bulge back braid and trim with scissors at edge of jacket.



**3.** Remove jacket to dimension "B."



**4.** Using dielectric trim jig, trim dimension "C." Exposed center conductor length will be equal to dimension "D" of trim code.



**5.** Solder or crimp contact to center conductor.

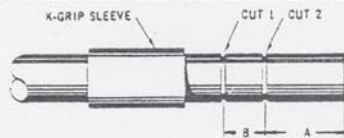


**6.** Push K-GRIP, Jr. over dielectric and under braid until dielectric bottoms in connector, or, for small cable, until shoulder on center contact bottoms against contact positioning jig.




**7.** Slide K-GRIP sleeve against shoulder on body and form hex by crimping.


TRIM CODE CHART				
CODE	A	B	C	D
416	25/64	7/32	.453	5/32




**1.** Cut cable end square, slide K-GRIP sleeve over jacket and with jacket trim jig make cuts 1 and 2 in jacket.




**2.** Remove jacket to dimension "A," flare or bulge back braid and trim with scissors at edge of jacket.



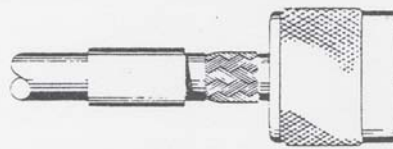
**3.** Remove jacket to dimension "B."



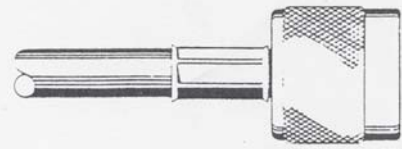
**4.** Using dielectric trim jig, trim dimension "C." Exposed center conductor length will be equal to dimension "D" of trim code.



**5.** Solder ~~contact~~ contact to center conductor.

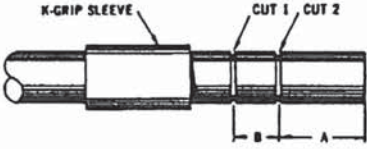


**6.** Push K-GRIP, Jr. over dielectric and under braid until dielectric bottoms in connector, or, for small cable, until shoulder on center contact bottoms against contact positioning jig.




**7.** Slide K-GRIP sleeve against shoulder on body and form hex by crimping.


TRIM CODE CHART				
CODE	A	B	C	D
420	5/8	7/32	.600	1/4




**1.** Cut cable end square, slide K-GRIP sleeve over jacket and with jacket trim jig make cuts 1 and 2 in jacket.




**2.** Remove jackets to dimension "A," flare or bulge back braid and trim with scissors at edge of jacket.



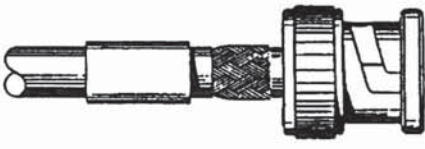
**3.** Remove jacket to dimension "B."



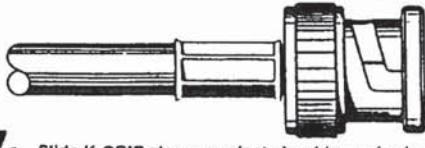
**4.** Using dielectric trim jig, trim dimension "C." Exposed center conductor length will be equal to dimension "D" of trim code.



**5.** Solder or crimp contact to center conductor.

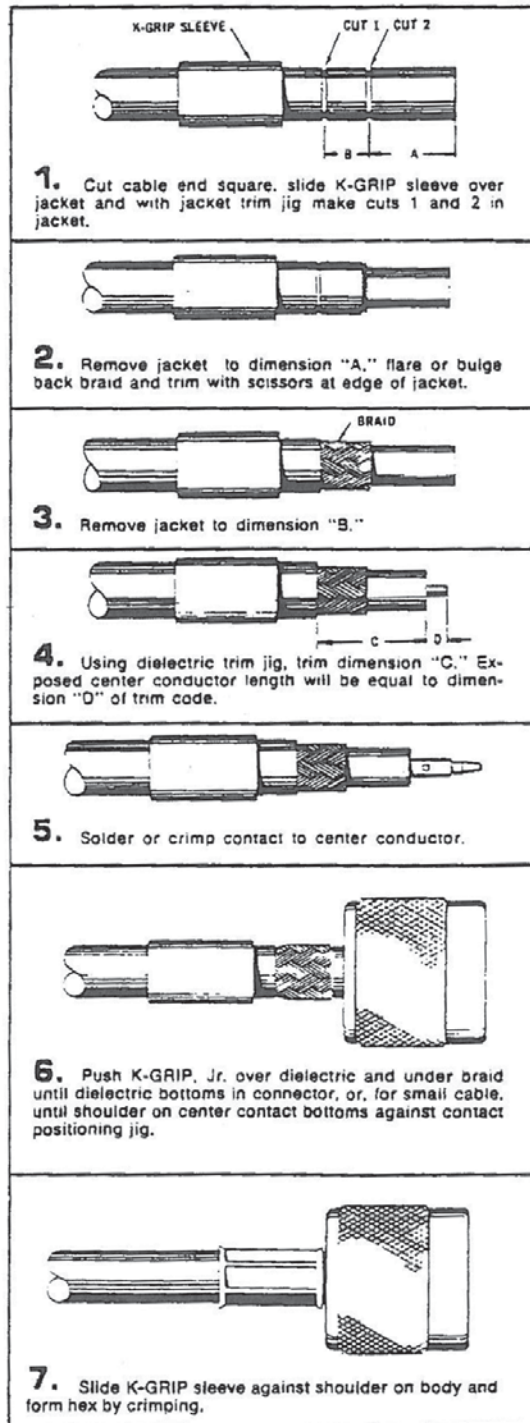


**6.** Push K-GRIP Jr. over dielectric and under braid until dielectric bottoms in connector. When the "B" dimension in the trim code is 0, the K-GRIP Jr. is pushed under both braid and jacket. Teflon jackets may be slit axially 1/4" in two places to facilitate entry of the K-GRIP.



**7.** Slide K-GRIP sleeve against shoulder on body and form hex.  
For captive contact connectors, solder contact to center conductor and thread assembly into connector.

TRIM CODE CHART				
CODE	A	B	C	D
425	19/32	0	.316	9/32



TRIM CODE CHART				
CODE	A	B	C	D
444	7/16	9/32	.500	7/32





**1.** Cut cable end square, slide K-GRIP sleeve over jacket and with jacket trim jig make cuts 1 and 2 in jacket.



**2.** Remove jacket to dimension "A," flare or bulge back braid and trim with scissors at edge of jacket.



**3.** Remove jacket to dimension "B."



**4.** Using dielectric trim jig, trim dimension "C." Exposed center conductor length will be equal to dimension "D" of trim code.



**5.** Solder or crimp contact to center conductor.



**6.** Push K-GRIP, Jr. over dielectric and under braid until dielectric bottoms in connector, or, for small cable, until shoulder on center contact bottoms against contact positioning jig.

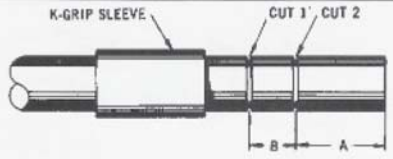


**7.** Slide K-GRIP sleeve against shoulder on body and form hex by crimping.


TRIM CODE CHART				
CODE	A	B	C	D
460	17/32	7/32	.541	13/64




TRIM CODE CHART				
CODE	A	B	C	D
472	USE	CP-5401		




**1.** Cut cable end square, slide K-GRIP sleeve over jacket and with jacket trim jig make cuts 1 and 2 in jacket




**2.** Remove jackets to dimension "A," flare or bulge back braid and trim with scissors at edge of jacket.



**3.** Remove jacket to dimension "B."



**4.** Using dielectric trim jig, trim dimension "C." Exposed center conductor length will be equal to dimension "D" of trim code.



**5.** Solder or crimp contact to center conductor.  
**5A.** For 10 & 20 KV connectors, when Cable Seal Gasket is supplied, place over center conductor and against cable dielectric. Solder contact to center conductor with gasket under compression.



**6.** Push K-GRIP Jr. over dielectric and under braid until dielectric bottoms in connector. When the "B" dimension in the trim code is 0, the K-GRIP Jr. is pushed under both braid and jacket. Teflon jackets may be slit axially 1/4" in two places to facilitate entry of the K-GRIP. When center contact is undercut captive type, insert cable assembly until insulator detent locks into contact.

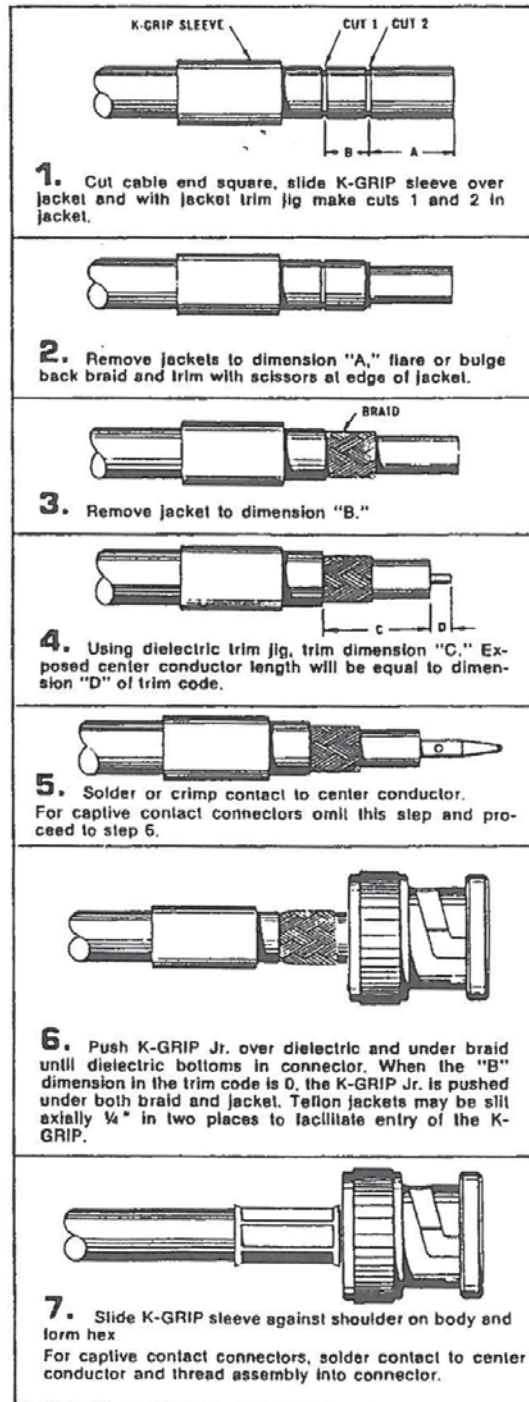


**7.** Slide K-GRIP sleeve against shoulder on body and form hex. For captive contact connectors, solder contact to center conductor and thread assembly into connector.

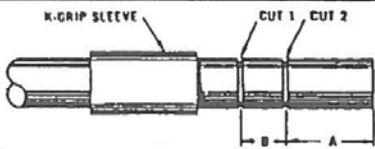
All Dimensions in Inches

TRIM CODE CHART				
CODE	A	B	C	D
465	1/4	11/32	.432	5/32
489	11/32	11/32	.500	3/16
5401	5/16	9/32	.432	5/32
5402	3/8	5/16	.500	3/16
5406	13/32	9/32	.500	3/16
5450	.400	.313	.525	.188







TRIM CODE CHART				
CODE	A	B	C	D
5455	.30	.28	.40	.18




**1.** Cut cable end square, slide K-GRIP sleeve over jacket and with jacket trim jig make cuts 1 and 2 in jacket.




**2.** Remove jackets to dimension "A," flare or bulge back braid and trim with scissors at edge of jacket.



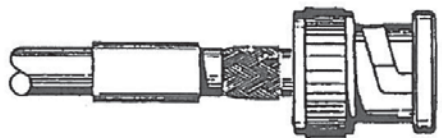
**3.** Remove jacket to dimension "B,"



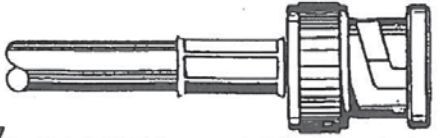
**4.** Using dielectric trim jig, trim dimension "C." Exposed center conductor length will be equal to dimension "D" of trim code.



**5.** Solder or crimp contact to center conductor. For captive contact connectors omit this step and proceed to step 6.



**6.** Push K-GRIP Jr. over dielectric and under braid until dielectric bottoms in connector. When the "B" dimension in the trim code is 0, the K-GRIP Jr. is pushed under both braid and jacket. Teflon jackets may be slit axially 1/4" in two places to facilitate entry of the K-GRIP.

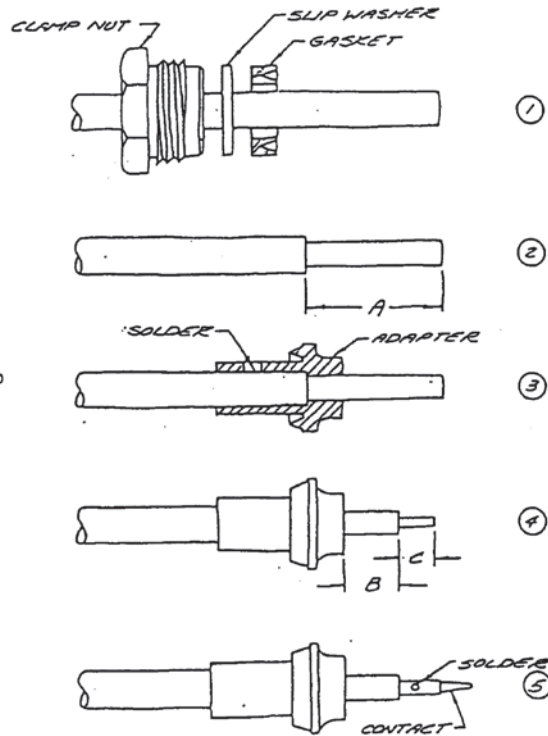


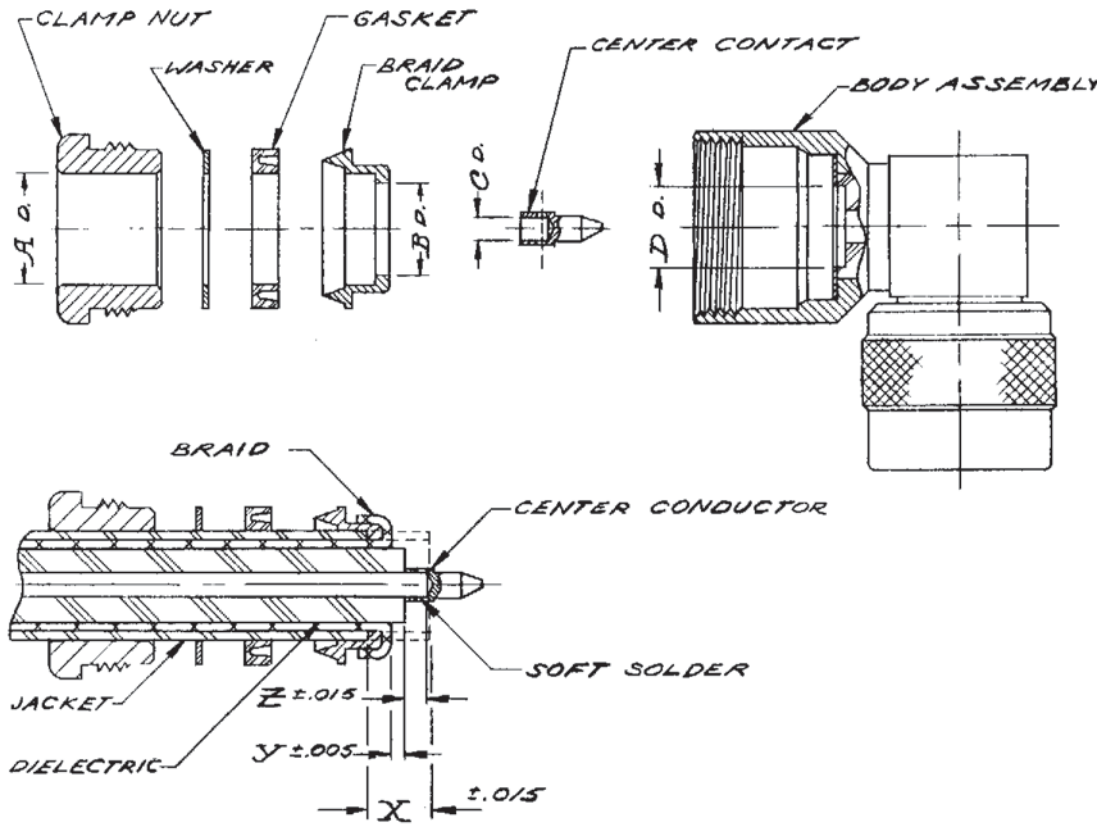
**7.** Slide K-GRIP sleeve against shoulder on body and form hex. For captive contact connectors, solder contact to center conductor and thread assembly into connector.

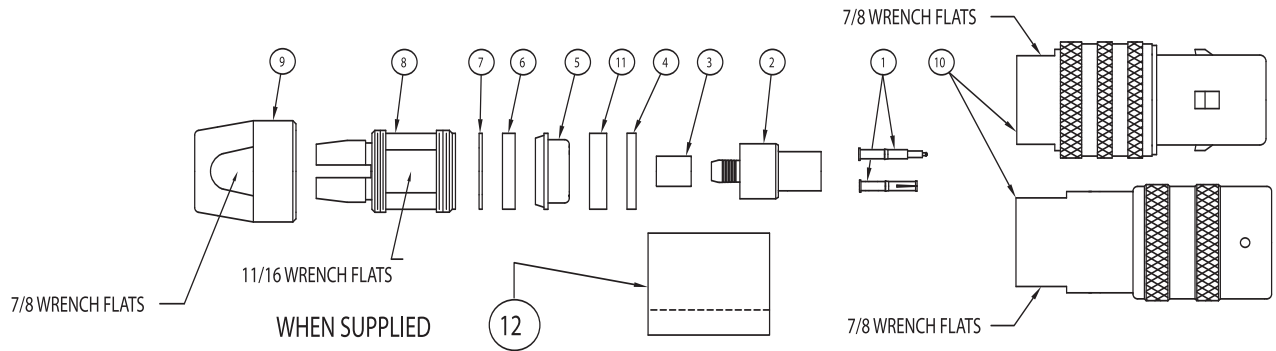
TRIM CODE CHART				
CODE	A	B	C	D
5458	.37	.31	.56	.12

1. CUT CABLE END SQUARE AND SLIDE CLAMP NUT, SLIP WASHER AND GASKET OVER OUTER CONDUCTOR.
2. TRIM OUTER CONDUCTOR TO "A" DIMENSION WITHOUT CUTTING DIELECTRIC.
3. SLIDE ADAPTER OVER CABLE UNTIL ADAPTER BOTTOMS ON OUTER CONDUCTOR. SOLDER ADAPTER TO OUTER CONDUCTOR USING MINIMUM HEAT.
4. TRIM DIELECTRIC TO DIMENSION "B" AND CENTER CONDUCTOR TO DIMENSION "C".
5. SOLDER CONTACT TO CENTER CONDUCTOR.

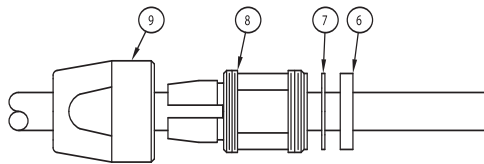
CODE	A	B	C
.708	.235	.045	.120



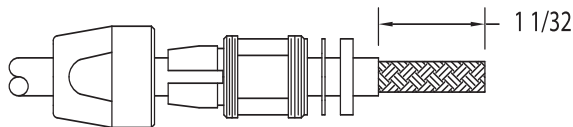




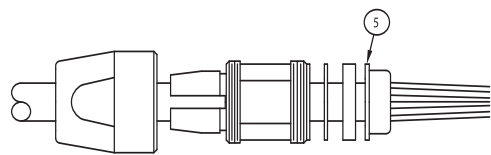
NOTE: CARE MUST BE TAKEN WHEN TRIMMING CABLE THAT THE BRAIDS, INSULATORS AND CONDUCTORS OF THE CABLE ARE NOT NICKED OR DAMAGED.



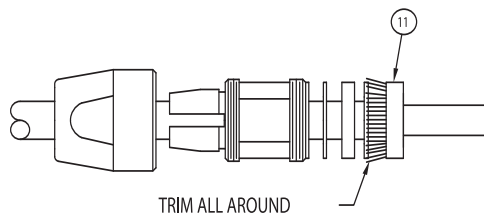
1. CUT CABLE END SQUARE. PLACE NUT (ITEM 9), COLLET (ITEM 8), THIN WASHER (ITEM 7), AND GASKET (ITEM 6) OVER THE JACKET.



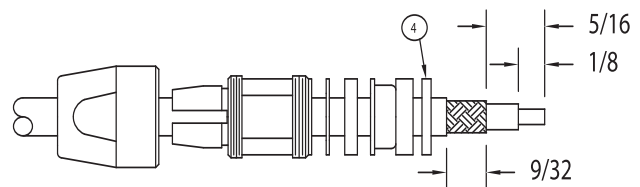
2. REMOVE OUTER JACKET TO 1-1/32" DIMENSION SHOWN.



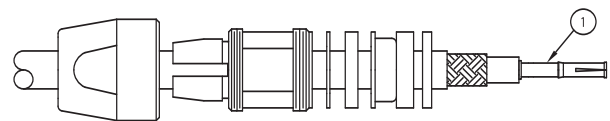
3. PLACE BRAID CLAMP (ITEM 5) OVER THE OUTER BRAID AND SEAT AGAINST THE OUTER JACKET.



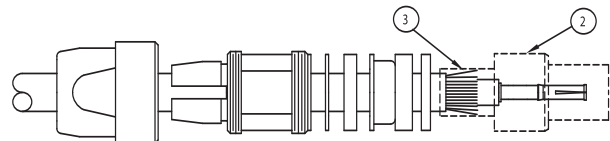
4. FOLD THE OUTER BRAID BACK OVER THE BRAID CLAMP, AND PRESS THE OUTER GROUND RING (ITEM 11) OVER THE BRAID AND BRAID CLAMP SO THAT THE OUTER GROUND RING IS FLUSH TO THE EDGE OF THE BRAID CLAMP. TRIM EXCESS BRAID THAT EXTENDS BEYOND THE OUTER DIAMETER OF THE BRAID CLAMP.



5A. REMOVE INNER JACKET AND INNER BRAID TO 5/16" DIMENSION. REMOVE INNER JACKET AN ADDITIONAL 9/32". DO NOT NICK BRAID.  
 B. REMOVE INNER DIELECTRIC TO 1/8" DIMENSION TO EXPOSE INNER CONDUCTOR. DO NOT NICK OR UNRAVEL CENTER CONDUCTOR.  
 C. PLACE THICK WASHER (ITEM 4) AGAINST RING.

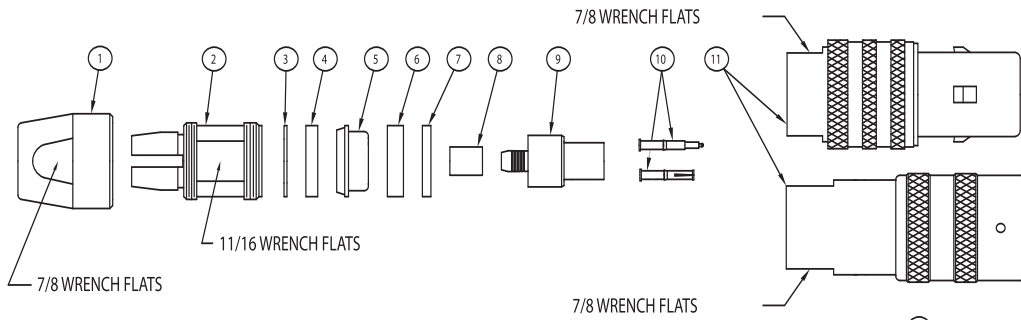


6. PLACE THE MALE OR FEMALE CONNECTOR CONTACT (ITEM 1) OVER THE CENTER CONDUCTOR OF THE CABLE AND BUTT IT AGAINST THE CORE. CRIMP OR SOLDER THE CONTACT TO THE CORE.

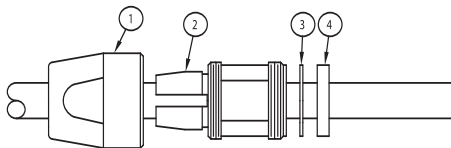


PLACE CRIMP SLEEVE (ITEM 3) OVER INNER BRAID OF THE CABLE. SLIDE BODY ASSEMBLY (ITEM 2) OVER THE CORE (INNER DIELECTRIC) AND UNDER THE INNER BRAID UNTIL THE CONTACT BOTTOMS IN THE CONNECTOR. (NOTE: CAUTION MUST BE EXERCISED TO NOT ALLOW ANY OF THE BRAID TO REMAIN INSIDE THE CONNECTOR ASSEMBLY. ALL BRAID MUST BE ON THE OUTSIDE OF THE BODY.) SLIDE THE CRIMP SLEEVE OVER BODY AND BRAID TO WITHIN 1/64" OF THE BODY SHOULDER. CRIMP THE SLEEVE.

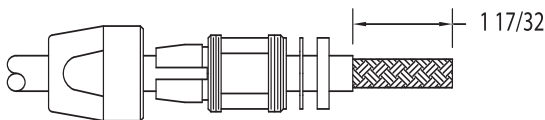
SLIDE CONNECTOR INTO MAIN CONNECTOR BODY (ITEM 10). TIGHTEN COLLET TO BODY WITH A MINIMUM OF 80 INCH POUNDS OF TORQUE. IT IS RECOMMENDED NOT TO EXCEED 125 INCH POUNDS OF TORQUE. LOCK CLAMP NUT TO COLLET TO PREVENT ROTATION OF CABLE WITHIN THE CONNECTOR.  
 "U" SPACER, ITEM 12, IS SUPPLIED ONLY WITH SMALL CABLE CONNECTORS. IT IS PLACED OVER ITEM 3 AFTER CRIMPING AND BEFORE THREADING CABLE ASSEMBLY INTO BODY.



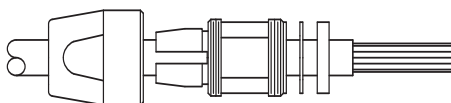
NOTE: CARE MUST BE TAKEN WHEN TRIMMING CABLE THAT THE BRAIDS, INSULATORS AND CONDUCTORS OF THE CABLE ARE NOT NICKED OR DAMAGED.



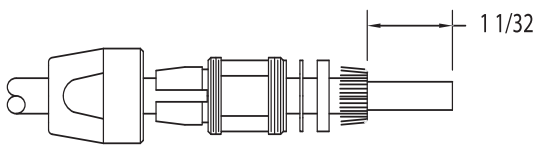
1. CUT CABLE END SQUARE. PLACE NUT (ITEM 1), COLLET (ITEM 2), THIN WASHER (ITEM 3), AND GASKET (ITEM 4) OVER THE JACKET.



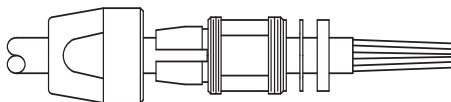
2. REMOVE OUTER JACKET TO 1-17/32" DIMENSION SHOWN.



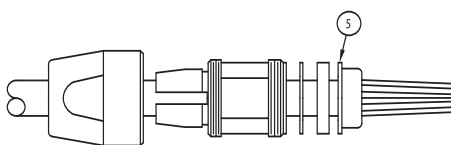
3. COMB OUT BRAID AS SHOWN.



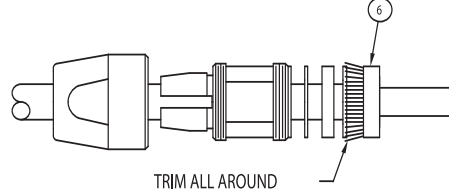
4. FOLD BRAID BACK AND TRIM CABLE BACK 1/2".



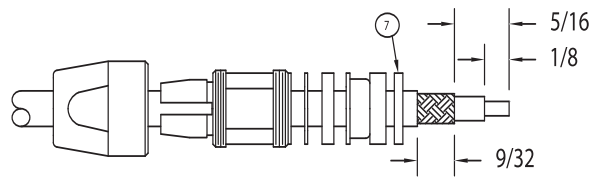
5. COMB OUT BRAID AGAIN AND FORM END AS SHOWN.



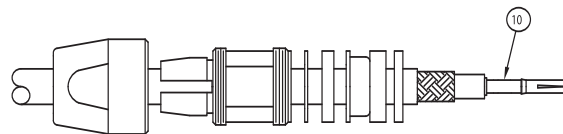
6. PLACE BRAID CLAMP (ITEM 5) OVER THE OUTER BRAID AND SEAT AGAINST THE OUTER JACKET.



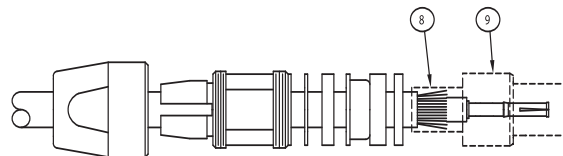
7. FOLD THE OUTER BRAID BACK OVER THE BRAID CLAMP, AND PRESS THE OUTER GROUND RING (ITEM 6) OVER THE BRAID AND BRAID CLAMP SO THAT THE OUTER GROUND RING IS FLUSH TO THE EDGE OF THE BRAID CLAMP. TRIM EXCESS BRAID THAT EXTENDS BEYOND THE OUTER DIAMETER OF THE BRAID CLAMP.



8A. REMOVE INNER JACKET AND INNER BRAID TO 5/16" DIMENSION. REMOVE INNER JACKET AN ADDITIONAL 9/32". DO NOT NICK BRAID.  
8B. REMOVE INNER DIELECTRIC TO 1/8" DIMENSION TO EXPOSE INNER CONDUCTOR. DO NOT NICK OR UNRAVEL CENTER CONDUCTOR.  
8C. PLACE THICK WASHER (ITEM 7) AGAINST GROUND RING.

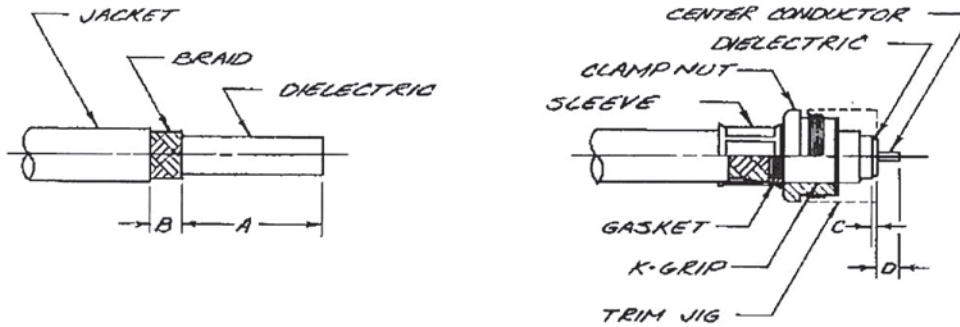


9. PLACE THE MALE OR FEMALE CONNECTOR CONTACT (ITEM 10) OVER THE CENTER CONDUCTOR OF THE CABLE AND BUTT IT AGAINST THE CORE. CRIMP OR SOLDER THE CONTACT TO THE CORE.



10. PLACE CRIMP SLEEVE (ITEM 8) OVER INNER BRAID OF THE CABLE. SLIDE BODY ASSEMBLY (ITEM 9) OVER THE CORE (INNER DIELECTRIC) AND UNDER THE INNER BRAID UNTIL THE CONTACT BOTTOMS IN THE CONNECTOR. (NOTE: CAUTION MUST BE EXERCISED NOT TO ALLOW ANY OF THE BRAID TO REMAIN INSIDE THE CONNECTOR ASSEMBLY. ALL BRAID MUST BE ON THE OUTSIDE OF THE BODY.) SLIDE THE CRIMP SLEEVE OVER BODY AND BRAID TO WITHIN 1/64" OF THE BODY SHOULD. CRIMP THE SLEEVE.

SLIDE CONNECTOR INTO MAIN CONNECTOR BODY (ITEM 11). TIGHTEN COLLET TO BODY WITH A MINIMUM OF 80 INCH POUNDS OF TORQUE. IT IS RECOMMENDED NOT TO EXCEED 125 INCH POUNDS OF TORQUE. LOCK CLAMP NUT TO COLLET TO PREVENT ROTATION OF CABLE WITHIN THE CONNECTOR.



1. Cut cable and square and slide K-grip sleeve over jacket.
2. Cut through jacket and braid to dimension A, leaving cut jacket and braid in place until step 3 below. This may be conveniently done with a B-T stripper which will cut cleanly through both jacket and braid. When cutting through braid avoid tangling strand ends.
3. Remove jacket to dimension B, without nicking braid. Remove braid cut to dimension A in step 2, above.
4. Flare out braid slightly to permit slotted end of K-grip to enter between dielectric and braid. Flaring tool S-89-24-5 may be used for this operation.
5. Assemble K-grip, gasket and clamp nut on K-grip.
6. Push K-grip over dielectric and under braid as far as it will go.
7. Slide K-grip sleeve forward over braid and K-grip gasket up to small shoulder on K-grip. Place assembly in K-grip forming tool centering sleeve between die halves and form hex.
8. Assemble dielectric trim jig to clamp nut, remove dielectric flush with jig and trim center conductor in usual manner.
9. Solder or crimp center contact to center conductor. Remove dielectric trim jig. Place connector gasket and braid clamp on K-grip. Then insert assembly into connector body and lock securely by clamp nut.

CABLE TRIM CODE

CODE	A	B	C	D
I	$1\frac{5}{32}$	$\frac{1}{4}$	.093	$\frac{3}{16}$
II	$1\frac{25}{32}$	$\frac{1}{4}$	.666	$\frac{3}{16}$
III	$1\frac{7}{16}$	$\frac{1}{4}$	.297	$\frac{7}{32}$
IV	$1\frac{1}{8}$	$\frac{1}{4}$	.093	$\frac{5}{32}$
V	$1\frac{13}{32}$	$\frac{1}{4}$	.333	$\frac{5}{32}$
VI	$1\frac{3}{32}$	$\frac{1}{4}$	.094	$\frac{1}{8}$
VII	$1\frac{53}{64}$	$\frac{1}{4}$	.437	$\frac{23}{32}$



Cable Design	Armor O.D. Max	Jacket O.D. Max	Braid O.D. Max	Dielectric O.D. Max	Center Conductor Stranding	Conductor O.D. Nom	Nominal Impedance Ohms	Max Freq. GHz	Max Power Watts at 400 MHz	M17/ Replacement	Notes
RG5B/U		0.335	.260 D	0.185	Solid	0.051	50			73-RG212	
RG6A/U		0.336	.264 D	0.189	Solid	0.029	75			2-RG6	
RG8A/U		0.415	.340 S	0.295	7/AWG21	0.086	52			74-RG213	
RG9B/U		0.43	.355 D	0.285	7/AWG21	0.086	50			75-RG214	
RG10A/U	0.475	0.415	.340 S	0.295	7/AWG21	0.086	52			74-RG215	
RG11A/U		0.412	.340 S	0.292	7/AWG26	0.048	75			6-RG11	
RG12A/U	0.475	0.412	.340 S	0.292	7/.0159	0.048	75			6-RG12	
RG13A/U		0.43	.355 D	0.29	7/AWG26	0.048	74			77-RG216	
RG14A/U		0.558	.463 D	0.383	Solid	0.102	52			78-RG217	
RG17/U		0.885	.760 S	0.695	Solid	0.188	52			79-RG218	
RG17A/U		0.885	.760 S	0.695	Solid	0.188	52			79-RG218	
RG18/U	0.945	0.885	.760 S	0.695	Solid	0.188	52			79-RG219	
RG18A/U	0.945	0.885	.760 S	0.695	Solid	0.188	52			79-RG219	
RG19/U		1.135	.760 S	0.695	Solid	0.188	52			81-00001	
RG19A/U		1.135	.990 S	0.925	Solid	0.25	52			81-00001	
RG20/U	1.195	1.135	.990 S	0.925	Solid	0.25	52			81-00002	
RG20A/U	1.195	1.135	.990 S	0.925	Solid	0.25	52			81-00002	
RG21/U		0.339	.264 D	0.192	Solid	0.051	53			162-00001	
RG21A/U		0.339	.264 D	0.192	Solid	0.051	53			162-00001	
RG22B/U		0.43	.355 D	0.291	7/.0152	0.046	95	200 MHz		15-RG22	Twin
RG55A/U		0.216	.171 D	0.116	Solid	0.035	50			84-RG223	
RG55B/U		0.206	.176 D	0.121	Solid	0.032	53.5			84-RG223	
RG58/U		0.199		0.12	Solid	0.032	53.5			28-RG58	
RG58A/U		0.199		0.12	19/AWG33	0.038	52			28-RG58	
RG58B/U		0.199		0.12	Solid	0.032	53.5			28-RG58	
RG58C/U		0.199	.150 S	0.12	19/AWG33	0.038	50			28-RG58	
RG59/U		0.242	.191 S	0.15	Solid		73			29-RG59	
RG59A/U		0.242	.191 S	0.15	Solid	0.023	73			29-RG59	
RG59B/U		0.246	.191 S	0.15	Solid	0.023	75			29-RG59	
RG62/U		0.249	.191 S	0.151	Solid	0.025	93			30-RG62	
RG62A/U		0.249	.191 S	0.151	Solid	0.025	93			30-RG62	
RG62B/U		0.249	.191 S	0.151	7/AWG32	0.025	93			30-RG62	
RG63B/U		0.415	.340 S	0.295	Solid	0.025	125			31-RG63	
RG71B/U		0.25	.208 D	0.151	Solid	0.025	93			90-RG71	
RG82/U		0.757		0.675	Solid	0.125	50				
RG108A/U		0.245	.177 S (Nom)	0.082	7/AWG28		78			45-RG108	Twin
RG114/U		0.415	.340 S	0.295	Solid	0.007	185			47-RG114	
RG114A/U		0.415	.340 S	0.295	Solid	0.007	185			47-RG114	
RG115/U		0.385	.320 D	0.255	7/.028		50			168-00001	
RG115A/U		0.43	.325 D	0.26	7/AWG21	0.086	50			168-00001	
RG117/U		0.745	.670 S	0.625	Solid	0.188	50			72-RG211	



# CABLE REFERENCE TABLE

Cable Design	Armor O.D. Max	Jacket O.D. Max	Braid O.D. Max	Dielectric O.D. Max	Center Conductor Stranding	Center Conductor O.D. Nom	Nominal Impedance Ohms	Max Freq. GHz	Max Power Watts at 400 MHz	M17/ Replacement	Notes
RG117A/U		0.745	.670 S	0.625	Solid	0.188	50			72-RG211	
RG118/U	0.795	0.745	.670 S	0.625	Solid	0.188	50			161-00002	
RG118A/U	0.795	0.745	.670 S	0.625	Solid	0.188	50			161-00002	
RG122/U		0.165	.126 S	0.099	27/AWG36	0.03	50			54-RG122	
RG141/U		0.195	0.146	0.121	Solid	0.036	50			111-RG303	
RG141A/U		0.195	.146 S	0.121	Solid	0.039	50			111-RG303	
RG142A/U		0.206	.171 D	0.121	Solid	0.039	50			60-RG142	
RG142B/U		0.2	.171 D	0.121	Solid	0.039	50			60-RG142	
RG143/U		0.332	0.25	0.19	Solid	0.057	50			112-RG304	
RG143A/U		0.332	.250 D	0.19	Solid	0.059	50			112-RG304	
RG174/U		0.105	.088 S	0.063	7/AWG34	0.02	50			119-RG174	
RG174A/U		0.105	.088 S	0.063	7/AWG34	0.02	50			119-RG174	
RG178B/U		0.075	.054 S	0.036	7/AWG38	0.012	50			93-RG178	
RG179B/U		0.105	.084 S	0.066	7/AWG38	0.012	75			94-RG179	
RG180B/U		0.145	.124 S	0.105	7/AWG38	0.012	95			95-RG180	
RG187A/U		0.11	.084 S	0.066	7/AWG38	0.012	75			136-00001	
RG188A/U		0.11	.081 S	0.063	7/.0067	0.02	50			138-00001	
RG189/U		0.875		0.632	Solid	0.251	50				Helix, (Nom Dims.)
RG195/U		0.155	.124 S	0.105	7/.004	0.012	95			137-00001	
RG195A/U		0.155	.124 S	0.105	7/AWG38	0.012	95			137-00001	
RG196/U		0.08	.054 S	0.036	7/.004	0.012	50			93-00001	
RG196A/U		0.08	.054 S	0.036	7/AWG38	0.012	50				
RG210/U		0.25	.191 S	0.151	Solid	0.025	93			97-RG210	
RG211A/U		0.745	.670 S	0.625	Solid	0.19	50			72-RG211	
RG212/U		0.336	.265 D	0.189	Solid	0.056	50			73-RG212	
RG213/U		0.412	.340 S	0.292	7/.0296	0.089	50			74-RG213	
RG214/U		0.432	.360 D	0.292	7/.0296	0.089	50			75-RG214	
RG215/U	0.475	0.412	.340 S	0.292	7/.0296	0.089	50			74-RG215	
RG216/U		0.432	.360 D	0.292	7/AWG26	0.048	75			77-RG216	
RG217/U		0.555	.463 D	0.38	Solid	0.106	50			78-RG217	
RG218/U		0.88	.760 S	0.69	Solid	0.195	50			79-RG218	
RG219/U	0.945	0.88	.760 S	0.69	Solid	0.195	50			79-RG219	
RG220/U		1.135	.990 S	0.925	Solid	0.26	50			81-00001	
RG221/U	1.195	1.135	.990 S	0.925	Solid	0.26	50			81-00002	
RG222/U		0.336	.264 D	0.189	Solid	0.056	50			162-00001	
RG223/U		0.216	.176 D	0.12	Solid	0.035	50			84-RG223	
RG224/U	0.615	0.555	.463 D	0.38	Solid	0.106	50			165-00002	
RG225/U		0.44	.360 D	0.29	7/.031	0.094	50			127-RG393	
RG228/U	0.795	0.745	.670 S	0.625	Solid	0.19	50			161-00002	
RG228A/U	0.795	0.745	.670 S	0.625	Solid	0.19	50			161-00002	
RG301/U		0.25	.215 S	0.19	7/.0203	0.0609	50			109-RG301	

Cable Design	Armor O.D. Max	Jacket O.D. Max	Braid O.D. Max	Dielectric O.D. Max	Center Conductor Stranding	Center Conductor O.D. Nom	Nominal Impedance Ohms	Max Freq. GHz	Max Power Watts at 400 MHz	M17/ Replace ment	Notes
RG302/U		0.206	.176 S	0.151	Solid	0.025	75			109-RG302	
RG303/U		0.175	.146 S	0.121	Solid	0.039	50			111-RG303	
RG304/U		0.285	.250 D	0.19	Solid	0.059	50			112-RG304	
RG316/U		0.102	.081 S	0.063	7/.0067	0.02	50			113-RG316	
RG389/U		0.875		0.635	Solid	0.25	50				Spline, (Nom Dims.)
RG393/U		0.4	.360 D	0.29	7/.0312	0.094	50			127-RG393	
RG400/U		0.2	.171 D	0.121	19/AWG33	0.039	50			128-RG400	
RG401/U		0.251		0.211	Solid	0.0641	50			129-RG401	Semi-Rigid
RG402/U		0.141		0.118	Solid	0.036	50			130-RG402	Semi-Rigid
RG403/U		0.128	.098 D	0.036	7/AWG38	0.012	50			131-RG403	
RG404/U		0.075	.056 S	0.036	7/AWG38	0.012	50			132-RG404	
RG405/U		0.086		0.066	Solid	0.02	50			133-RG405	Semi-Rigid
M17/2-RG6		0.336	.264 D	0.189	Solid	0.0285	75	3	210		
M17/6-RG11		0.412	.340 S	0.292	7/.0159	0.0477	75	1	290		
M17/6-RG12	0.475	0.412	.340 S	0.292	7/.0159	0.0477	75	1	290		
M17/15-RG22		0.43	.355 D	0.291	7/.0159	0.046	95	200 MHz			Twin
M17/28-RG58		0.199	.105 S	0.12	19/.0072	0.0355	50	1	90		
M17/29-RG59		0.246	.191 S	0.15	Solid	0.0226	75	1	130		
M17/30-RG62		0.249	.191 S	0.15	Solid	0.0253	93	1	9		
M17/31-RG63		0.415	.340 S	0.295	Solid	0.0253	125	1	330		
M17/45-RG108		0.245	.177 S (Nom)	0.081	7/.0126	0.0378	78	10 MHz			Twin
M17/47-RG114		0.415	.340 S	0.295	Solid	0.007	185	1	150		
M17/54-RG122		0.165	.126 S	0.099	27/.005	0.0308	50	1	62		
M17/60-RG142		0.2	.171 D	0.121	Solid	0.037	50	12.4	1000		
M17/72-RG211		0.745	.670 S	0.625	Solid	0.192	50	1	11000		
M17/73-RG212	0.475	0.336	.265 D	0.189	Solid	0.0556	50	11	350		
M17/74-RG213		0.412	.340 S	0.292	7/.0296	0.0888	50	1	320		
M17/74-RG215	0.475	0.412	.340 D	0.292	7/.0296	0.0888	50	1	320		
M17/75-RG214		0.432	.360 D	0.292	7/.0296	0.0888	50	11	330		
M17/77-RG216		0.432	.360 D	0.292	7/.0159	0.0477	75	3	270		
M17/78-RG217		0.545	.463 D	0.38	Solid	0.106	50	3	470		
M17/79-RG218		0.88	.760 S	0.69	Solid	0.195	50	1	1200		
M17/79-RG219	0.945	0.88	.760 S	0.69	Solid	0.195	50	1	1200		
M17/81-00001		1.135	.990 S	0.925	Solid	0.26	50				
M17/81-00002	1.195	1.135	.990 S	0.925	Solid	0.26	50				
M17/84-RG223		0.216	.176 D	0.12	Solid	0.035	50	12.4	86		
M17/90-RG71		0.25	.208 D	0.151	Solid	0.0253	93				
M17/93-RG178		0.075	.054 S	0.035	7/.004	0.012	50	3	110		
M17/93-00001		0.075	.054 S	0.035	7/.004	0.012	50	3	110		
M17/94-RG179		0.105	.084 S	0.066	7/.004	0.012	75	3	450		
M17/95-RG180		0.145	.124 S	0.105	7/.004	0.012	95	3	550		

## CABLE REFERENCE TABLE

Cable Design	Armor O.D. Max	Jacket O.D. Max	Braid O.D. Max	Dielectric O.D. Max	Center Conductor Stranding	Center Conductor O.D. Nom	Nominal Impedance Ohms	Max Freq. GHz	Max Power Watts at 400 MHz	M17/ Replacement	Notes
M17/97-RG210		0.25	.191 S	0.151	Solid	0.0253	93	3	1050		
M17/110-RG302		0.207	.176 S	0.15	Solid	0.0253	75	3	1600		
M17/111-RG303		0.175	.146 S	0.121	Solid	0.037	50	3	1100		
M17/112-RG304		0.288	.250 D	0.19	Solid	0.059	50	12	1450		
M17/113-RG316		0.012	0.0815	0.063	7/.0067	0.0201	50	3	210		
M17/116-RG307		0.27	0.237	0.149	19/.0058	0.029	75	1	130		
M17/119-RG174		0.115	0.0885	0.063	7/.0063	0.0189	50	1	26		
M17/127-RG393		0.4	.360 D	0.29	7/.0312	0.094	50	11	800		
M17/128-RG400		0.2	.171 D	0.121	19/.008	0.0384	50	12.4	1050		
M17/129-RG401		0.251		0.211	Solid	0.0641	50	18	1900		Semi-Rigid
M17/129-00001		0.251		0.211	Solid	0.0641	50	18	1900		Semi-Rigid
M17/130-RG402		0.142		0.1185	Solid	0.0362	50	20	660		Semi-Rigid
M17/130-00001		0.143		0.1185	Solid	0.0362	50	20	660		Semi-Rigid
M17/130-00002		0.142		0.1185	Solid	0.0362	50	20	660		Semi-Rigid
M17/131-RG403		0.128	.098 D	0.035	7/AWG38	0.012	50	10	95		
M17/132-RG404		0.077	.056 S	0.038	7/AWG38	0.012	50	1			
M17/133-RG405		0.0875		0.068	Solid	0.0201	50	20	210		Semi-Rigid
M17/133-00001		0.0885		0.068	Solid	0.0201	50	20	210		Semi-Rigid
M17/133-00002		0.0875		0.068	Solid	0.0201	50	20	210		Semi-Rigid
M17/134-00001		0.25	0.203	0.12	Solid	0.033	50	3	60		Triax
M17/134-00002		0.25	0.203	0.12	Solid	0.033	50	3	60		Triax
M17/136-00001		0.105	.084 S	0.066	7/.004	0.012	75	3	1400		
M17/137-00001		0.145	.124 S	0.105	7/.004	0.012	95	3	600		
M17/138-00001		0.102	.081 S	0.063	7/.0067	0.0201	50	3	220		
M17/161-00001		0.745	.670 S	0.625	Solid	0.192	50	400 MHz			
M17/161-00002	0.795	0.745	.670 S	0.625	Solid	0.192	50	400 MHz			
M17/162-00001		0.336	.265 D	0.189	Solid	0.0556	50	400 MHz			
M17/165-00001		0.555	.463 D	0.38	Solid	0.106	50	400 MHz			
M17/165-00002	0.615	0.555	.463 D	0.38	Solid	0.106	50	400 MHz			
M17/168-00001		0.43	.325 D	0.26	7/.028	0.084	50	400 MHz			
M17/168-00002		0.354	.325 D	0.26	7/.028	0.084	50	400 MHz			
M17/176-00002		0.134	.102 S	0.044	19/AWG36	0.024	77	10 MHz			Twin
M17/177-00001		0.189	0.162	0.105	7/.004	0.012	95	3	660		Triax
M17/178-00001		0.27	0.225	0.105	7/.004	0.012	95	3	550		Triax
M17/179-00001		0.195	0.17	0.066	7/.004	0.012	75	3	450		

Cable Group	Cable Type	Cable PN
A	Military Approved	M17/93-00001 RG-178 RG-178A RG-178B RG-196 RG-196A
B1	Military Approved	M17/138-00001 RG-174 RG-188 RG-188A RG-316
B2	Military Approved	M17/136-00001 RG-179 RG-179A RG-179B RG-187 RG-187A
C1	Military Approved	RG-122
C2	Military Approved	M17/137-00001 RG-180 RG-180A RG-180B RG-195 RG-195A
C3	Belden Essex	8218 21-597
D	Military Approved Military Approved Military Approved Military Approved Military Approved Belden Belden Belden	RG-141 RG-141A RG-303 RG-58* RG-58A* RG-58C* 8259 8262 9201
E1	Military Approved	RG-142 RG-142A RG-223 RG-400 RG-55A
E2	Military Approved	RG-142B RG-55* RG-55B*
G1	Military Approved	RG-210 RG-59 RG-59A RG-59B RG-62 RG-62A RG-62B RG-62C"
G2	Military Approved	RG-71 RG-71A RG-71B
H	Military Approved	RG-302
K1	Military Approved	M17/162-00001 RG-21 RG-212 RG-21A RG-5 RG-5A RG-5B
K2	Military Approved	RG-6 RG-6A

Cable Group	Cable Type	Cable PN
K3	Military Approved	M17/162-00001 RG-143 RG-143A RG-212 RG-222 RG-304
L	Military Approved	M17/168-00001 RG-115A
M1	Military Approved	RG-213 RG-8 RG-8A
M2	Military Approved	RG-11 RG-11A
N1	Military Approved	RG-214 RG-9 RG-9A RG-9B
N2	Military Approved	RG-13A RG-216
N3	Military Approved	RG-225 RG-393
P	Military Approved	RG-108 RG-393
Q	Belden WE	8281 24
R	Military Approved	M17/165-00002 RG-14 RG-14A RG-217RG-224**
T	Military Approved	RG-17A RG-218 RG-219**
U	Military Approved	RG-10** RG-12** RG-215**
V	Times Military Approved Military Approved	TRF-58 M17/134-00001 M17/134-00003
W	Military Approved	M17/176-00002
X	Military Approved	RG-405
Y	Military Approved	RG-401
Z	Raytheon Military Approved	11464213 RG-307
I	Times Military Approved Military Approved Military Approved	AA6343 RG-142 RG-223 RG-400
2	ITT Military Approved	BA6903 RG-214
3	Military Approved	M17/152-00001 RD-316
4	Military Approved	RG-393
5	Times	AA 2831 FEP 226
6	Times	AA 5885
7	Times	AA 5886
8	Times	AA 5887
9	Times	AA 5888

Cable Group	Cable Type	Cable PN
10	Times	AA 5889
11	McDonnell Douglas	BXS 7004-502-06090
12	ECS Raychem ITT	311201 5012H3012 BA 20048
13	Teledyne Thermatics	13784
14	Teledyne Thermatics	13850
15	Boeing Boeing Adams Russell	BMS 13-65 Type 0E S280W503-1 FC11Z
16	Boeing Boeing Adams Russell	BMS 13-65 Type 0F S280W503-2 FC14Z
17	Boeing Boeing Adams Russell	BMS 13-65 Type 0G S280W503-3 FC20Z
18	Boeing Boeing Adams Russell	BMS 13-65 Type 0H S280W503-4 FC28Z
19	Boeing Boeing Adams Russell	BMS 13-65 Type 0J S280W503-5 FC38Z
20	Boeing Boeing Adams Russell	BMS 13-65 Type 0K S280W503-6 FC48Z
21	Boeing Adams Russell	HS5965-2 FC09Z
22	Andrew Andrew Andrew	FHJ2-50A FSJ4-50B FSJ4RN-50B
23A	Belden Belden	1279P 1279R
23B	Belden	179DT
24	Belden Belden GepCo	1505A 9259 VPM2000
25	Belden GepCo	1694A VSD2001
26	Belden GepCo	1855A VDM230
27	Belden Belden Belden Belden Belden	8279 8279A 9209 9209A 9244
28	Military Approved	M17/179-20001
29	Military Approved	D3-7619-5/338
30	Telecommunications	734
31	Telecommunications	735
40	LASL Type	C-9Y19503
41	Belden	YR49220
42	Dielectric Science	2075
43	Gore Gore Raychem Raychem Raychem	GSC-12-2548 GSC-12-2549 10-613 10-614 2524E0114

Cable Group	Cable Type	Cable PN
44	Raychem	5026N5611
45	ITT ITT Times	BA 13077A BA 14349 MI 5406
46	Essex	21-204
47	Raychem ITT	752405011 BA 6416A
48	Semi Rigid	0.86
49	Semi Rigid	0.141 RG-402"
50	Semi Rigid	0.085 RG-405
51	Semi Rigid	0.047"
52	Dielectric Science	RD 178
70	Belden West Penn/CDT West Penn/CDT GepCo GepCo	8233 3811 1150 VT6181IPE VT6181I
73	Belden Belden Belden GepCo GepCo	1856A 1857A 9267 LVT61859 VT61859
74	Belden GepCo	9232 LVT6181I
76	Belden Belden West Penn/CDT	8232 8232A 3815
78	Belden	88232
79	Belden West Penn/CDT GepCo	1859A 253811 VT6181ITK
80	Belden	7784AS
81	Belden Belden Belden Belden Belden Belden Belden GepCo Times	7731A 7732A 8213 8231 8238 8261 9011 9292 VHD1100 LMR 400-75
82	Times	LMR 100
83	Times	LMR 195
84	Times	LMR 200
85	Times	LMR 300
86	Times	LMR 400
87	Times	LMR 500
88	Times	LMR 600
89	Times	LMR 240
90	Times	

**AMPLIFIER**

A device used to increase the operating level of an input signal. Used in a cable system's distribution plant to compensate for the effects of attenuation caused by coaxial cable and passive device losses.

**ANSI**

American National Standards Institute

**ATTENUATION**

The difference between transmitted and received power due to loss from lines, electronic components, or other transmission devices; usually expressed in decibels (dB).

**BODY**

Main or largest portion of a connector to which other components are attached.

**BRAID**

Weave of metal fibers used as a shield covering for an insulated conductor or a group of insulated conductors.

**BULKHEAD**

Term used to define a mounting style of connectors. Bulkhead connectors are designed to be inserted into a panel cutout from the front or the rear of the panel, and typically secured with a jam nut.

**COAXIAL CABLE**

Cable composed of an insulated central conducting wire, wrapped in another cylindrical conducting wire or braid. Coax cable has great capacity to carry high speed data typically used in Cable TV, connecting computers and central office switching.

**CONTACT**

Electrically conductive component designed for use in a multi-circuit connector.

**CONTACT ENGAGING and SEPARATING FORCE**

Force required to either engage or separate contacts.

**CONTACT RESISTANCE**

Measurement of electrical resistance of mated contacts when assembled in a connector under typical service use.

**DECIBEL (dB)**

A unit of measurement which expresses the ratio of two power levels on a logarithmic scale. It is used in cable systems to specify losses, k gains, and other ratios of power. The decibel is one-tenth of a Bel.

**FCC**

Federal Communications Commission

**IMPEDANCE**

Resistance to the flow of AC current. In telecommunications and broadcast systems, the characteristic impedance is 75 ohms. If all cable and devices are equal to the characteristic impedance, maximum signal will be transferred with little or no reflection.

**IMPEDANCE MISMATCH**

A situation that results when two components are connected, each having a different characteristic impedance. This generally results in adverse attenuation and return loss.

**INSERTION LOSS**

That property between the input and output of a device causing a predictable signal loss.

**INTERMODULATION**

Beats and harmonics creating interference due to the mixing of more than one carrier in an amplifying device. Usually to non-linear.

**ISO**

International Standards Organization

**MATCHED IMPEDANCE**

Coupling of two components or systems in such a way that the impedance of one system equals the impedance of the other system.

**NEBS**

National Equipment Building Systems

**OHM's LAW**

The relationship between voltage, current, and resistance in an electronic circuit. The third quantity can be found if two are known.

**PASSIVE DEVICE**

A device used in a cable system not requiring electrical power to operate. It normally represents loss to signals passing through it. Examples of passive devices are splitters, directional couplers, pads, and equalizers.

**RETURN LOSS**

The value (in decibels) of the ratio of the power or voltage loss between the forward (transmitted) wave and the reflected wave, as a result of impedance mismatch.

**RETURN PATH**

The band of frequencies used to return signals to the cable head-end either as control data or for redistribution on the forward path.

**RF**

Abbreviation for "radio frequency". Typically between 300KHz through 3GHz.

**RG/U**

(R—radio frequency, G—government approval number, U—universal specification). Symbol for Government specified coaxial cable.

**VSWR**

Abbreviation for Voltage Standing Wave Ratio, a measure of return loss of a transmission circuit.

# MILITARY CROSS REFERENCE

Military PN	KINGS® PN	Product Family	Page Number	Military PN	KINGS® PN	Product Family	Page Number
M39012/01-0005	KN-59-176	N Series	36	M39012/16-0015	755-115-5	50 Ohm BNC Series	7
M39012/01-0015	1205-37-5	N Series	36	M39012/16-0016	755-116-5	50 Ohm BNC Series	7
M39012/01-0017	1205-68-5	N Series	38	M39012/16-0017	755-117-5	50 Ohm BNC Series	7
M39012/01-0018	1205-69-5	N Series	38	M39012/16-0020	755-118-5	50 Ohm BNC Series	7
M39012/01-0101	KN-59-294	N Series	36	M39012/16-0101	KC-59-544	50 Ohm BNC Series	6
M39012/01-0104	KN-59-295	N Series	36	M39012/16-0101	755-74-5	50 Ohm BNC Series	6
M39012/01-0125	KN-59-296	N Series	36	M39012/16-0102	KC-59-545	50 Ohm BNC Series	6
M39012/01-0501	KN-59-239	N Series	38	M39012/16-0118	KC-59-548	50 Ohm BNC Series	6
M39012/01-0502	KN-59-202	N Series	38	M39012/16-0220	755-86-5	50 Ohm BNC Series	6
M39012/01-0503	KN-59-242	N Series	38	M39012/16-0501	755-119-5	50 Ohm BNC Series	7
M39012/01-0504	1205-19-5	N Series	38	M39012/16-0502	755-120-5	50 Ohm BNC Series	7
M39012/02-0003	KN-39-68	N Series	33	M39012/16-0503	755-121-5	50 Ohm BNC Series	7
M39012/02-0006	1201-9-5	N Series	34	M39012/16-0504	755-122-5	50 Ohm BNC Series	7
M39012/02-0006	KN-19-110	N Series	34	M39012/16B0004	KC-59-61	50 Ohm BNC Series	6
M39012/02-0131	KN-39-102	N Series	33	M39012/16B0004	KC-59-195	50 Ohm BNC Series	7
M39012/02-0501	KN-39-83	N Series	33	M39012/16B0007	KC-59-188	50 Ohm BNC Series	6
M39012/02-0503	KN-39-86	N Series	33	M39012/16B0008	KC-59-220	50 Ohm BNC Series	7
M39012/02-0513	KN-19-148	N Series	35	M39012/16B0009	KC-59-111	50 Ohm BNC Series	6
M39012/03-0012	KN-19-114	N Series	33	M39012/17-0014	KC-39-93	50 Ohm BNC Series	10
M39012/03-0501	KN-19-149	N Series	34	M39012/17-0020	KC-39-98	50 Ohm BNC Series	10
M39012/03-0502	KN-19-150	N Series	34	M39012/17-0101	KC-39-03	50 Ohm BNC Series	11
M39012/03-0503	KN-19-151	N Series	34	M39012/17-0502	KC-39-105	50 Ohm BNC Series	10
M39012/03-0504	1202-2-5	N Series	34	M39012/17-0503	KC-39-106	50 Ohm BNC Series	10
M39012/04-0001	KN-79-69	N Series	39	M39012/17-0504	KC-39-103	50 Ohm BNC Series	10
M39012/04-0002	KN-79-70	N Series	39	M39012/18-0102	KC-19-02	50 Ohm BNC Series	10
M39012/05-0101	KN-59-298	N Series	36	M39012/18-0502	KC-19-244	50 Ohm BNC Series	10
M39012/05-0501	KN-59-243	N Series	37	M39012/18-0503	KC-19-245	50 Ohm BNC Series	10
M39012/05-0502	KN-59-244	N Series	37	M39012/18B0007	KC-19-129	50 Ohm BNC Series	10
M39012/05-0503	KN-59-245	N Series	37	M39012/19-0013	KC-19-207	50 Ohm BNC Series	9
M39012/05-0504	1206-5-5	N Series	37	M39012/19-0014	KC-19-208	50 Ohm BNC Series	9
M39012/06-0002	KD-59-119	C Series	22	M39012/19-0020	KC-19-212	50 Ohm BNC Series	9
M39012/06-0003	KD-59-133	C Series	22	M39012/19-0101	KC-19-282	50 Ohm BNC Series	9
M39012/06-0014	795-10-5	C Series	22	M39012/19-0220	752-34-5	50 Ohm BNC Series	9
M39012/06-0015	795-9-5	C Series	22	M39012/19-0502	KC-19-248	50 Ohm BNC Series	9
M39012/08-0001	KD-19-72	C Series	23	M39012/19-0503	KC-19-249	50 Ohm BNC Series	9
M39012/09-0002	KD-19-65	C Series	23	M39012/19-0504	KC-19-250	50 Ohm BNC Series	9
M39012/10-0001	KD-59-134	C Series	21	M39012/19B0003	KC-19-50	50 Ohm BNC Series	9
M39012/11-0001	KD-19-61	C Series	23	M39012/20-0006	756-21-7	50 Ohm BNC Series	8
M39012/11-0002	KD-19-73	C Series	23	M39012/20-0007	756-19-7	50 Ohm BNC Series	8
M39012/12-0001	KD-79-14	C Series	23	M39012/20-0101	KC-59-533	50 Ohm BNC Series	8
M39012/128-0001	754-21-5	50 Ohm BNC Series	13	M39012/20-0101	756-9-5	50 Ohm BNC Series	8
M39012/13-0001	KD-79-13	C Series	23	M39012/20-0102	756-12-5	50 Ohm BNC Series	8
M39012/15-0001	KD-59-135	C Series	22	M39012/20-0501	KC-59-408	50 Ohm BNC Series	8
M39012/15-0002	KD-59-130	C Series	22	M39012/20-0502	KC-59-418	50 Ohm BNC Series	8
M39012/16-0001	KD-59-132	C Series	22	M39012/20-0503	KC-59-419	50 Ohm BNC Series	8
M39012/16-0013	755-114-5	50 Ohm BNC Series	7	M39012/20-0504	KC-59-420	50 Ohm BNC Series	8
M39012/16-0014	755-112-5	50 Ohm BNC Series	7	M39012/20B0003	KC-59-246	50 Ohm BNC Series	8



Military PN	KINGS® PN	Product Family	Page Number
M39012/21-0001	KC-79-105	50 Ohm BNC Series	13
M39012/21-0002	KC-79-106	50 Ohm BNC Series	13
M39012/22-0001	KC-79-109	50 Ohm BNC Series	12
M39012/23-0001	KC-79-110	50 Ohm BNC Series	13
M39012/23-0002	KC-79-111	50 Ohm BNC Series	13
M39012/24-0001	KC-79-107	50 Ohm BNC Series	13
M39012/24-0002	KC-79-108	50 Ohm BNC Series	13
M39012/25-0002	KD-89-08	C Series	21
M39012/25-0006	KC-89-87	50 Ohm BNC Series	11
M39012/25-0007	KC-89-88	50 Ohm BNC Series	11
M39012/25-0008	KC-89-89	50 Ohm BNC Series	11
M39012/25-0011	KN-89-30	N Series	41
M39012/25-0012	KN-89-31	N Series	41
M39012/25-0015	KC-89-92	50 Ohm BNC Series	11
M39012/25-0016	KC-89-93	50 Ohm BNC Series	11
M39012/25-0018	KA-81-02	TNC Series	80
M39012/25-0020	KA-81-01	TNC Series	80
M39012/25-0021	KA-89-82	TNC Series	80
M39012/25-0106	758-8-5	50 Ohm BNC Series	11
M39012/25-0118	128-26-5	TNC Series	80
M39012/25-0120	128-25-5	TNC Series	80
M39012/26-0010	KA-59-231	TNC Series	77
M39012/26-0011	KA-59-230	TNC Series	77
M39012/26-0012	KA-59-232	TNC Series	77
M39012/26-0013	KA-59-289	TNC Series	73
M39012/26-0021	KA-59-279	TNC Series	77
M39012/26-0022	125-19-5	TNC Series	77
M39012/26-0101	KA-59-22	TNC Series	73
M39012/26-0101	125-67-5	TNC Series	73
M39012/26-0102	KA-59-18	TNC Series	73
M39012/26-0501	KA-59-290	TNC Series	77
M39012/26-0502	KA-59-291	TNC Series	77
M39012/26-0503	KA-59-292	TNC Series	77
M39012/26-0504	KA-59-287	TNC Series	77
M39012/27-0101	KA-39-87	TNC Series	67
M39012/27-0503	KA-39-79	TNC Series	67
M39012/27-0504	KA-39-76	TNC Series	67
M39012/28-0010	KA-19-101	TNC Series	68
M39012/28-0011	KA-19-102	TNC Series	68
M39012/28-0018	122-32-5	TNC Series	68
M39012/28-0018	KA-19-171	TNC Series	68
M39012/28-0021	KA-19-146	TNC Series	68
M39012/28-0022	122-3-5	TNC Series	68
M39012/28-0101	KA-19-19	TNC Series	68
M39012/28-0101	122-27-5	TNC Series	68
M39012/28-0102	KA-19-172	TNC Series	68
M39012/28-0502	KA-19-151	TNC Series	68

Military PN	KINGS® PN	Product Family	Page Number
M39012/28-0503	KA-19-152	TNC Series	68
M39012/28-0504	KA-19-153	TNC Series	68
M39012/29-0014	KA-19-110	TNC Series	69
M39012/29-0018	KA-19-181	TNC Series	67
M39012/29-0022	KA-19-214	TNC Series	69
M39012/29-0101	KA-19-176	TNC Series	67
M39012/29-0502	KA-19-155	TNC Series	69
M39012/29-0503	KA-19-156	TNC Series	69
M39012/29-0504	KA-19-157	TNC Series	69
M39012/30-0010	KA-59-235	TNC Series	72
M39012/30-0011	KA-59-236	TNC Series	72
M39012/30-0012	KA-59-237	TNC Series	72
M39012/30-0022	126-8-5	TNC Series	72
M39012/30-0101	KA-59-343	TNC Series	73
M39012/30-0101	126-55-5	TNC Series	73
M39012/30-0102	126-54-5	TNC Series	73
M39012/30-0118	KA-59-348	TNC Series	73
M39012/30-0502	KA-59-295	TNC Series	72
M39012/30-0503	KA-59-296	TNC Series	72
M39012/30-0504	KA-59-297	TNC Series	72
M39012/31-0001	KA-71-02	TNC Series	78
M39012/31-0002	KA-71-08	TNC Series	78
M39012/32-0001	KA-79-39	TNC Series	78
M39012/34-0001	KA-71-03	TNC Series	78
M39012/34-0002	KA-71-04	TNC Series	78
M39012/55-3007	875-81-17	SMA Series	49
M39012/55-3009	875-82-17	SMA Series	49
M39012/55-3109	875-82-3	SMA Series	49
M39012/55-3130	875-86-3	SMA Series	49
M39012/55-3502	875-21-17	SMA Series	58
M39012/55-3602	875-21-3	SMA Series	58
M39012/55-4502	875-21-18	SMA Series	58
M39012/55B3112	875-9-3	SMA Series	58
M39012/55B3114	875-1-3	SMA Series	58
M39012/55B3116	875-3-3	SMA Series	58
M39012/56-3009	876-61-17	SMA Series	49
M39012/56-3030	876-62-17	SMA Series	49
M39012/56-3107	876-60-3	SMA Series	49
M39012/56-3130	876-62-3	SMA Series	49
M39012/56B3114	873-1-3	SMA Series	51
M39012/57-3502	873-18-3	SMA Series	51
M39012/57-4502	873-18	SMA Series	51
M39012/58B4012	871-13	SMA Series	51
M39012/61-3002	874-11-3	SMA Series	57
M39012/61-3002	874-2-3	SMA Series	57
M39012/61-4001	874-1	SMA Series	57
M39012/79-3008	875-70-17	SMA Series	49



## MILITARY CROSS REFERENCE

Military PN	KINGS® PN	Product Family	Page Number
M39012/79-3107	875-69-3	SMA Series	49
M39012/79-3108	875-70-3	SMA Series	49
M39012/80-3108	876-49-3	SMA Series	49
M39012/81-3008	873-19-3	SMA Series	48
M39012/82-3008	871-38-3	SMA Series	51
M39012/83-3007	872-36-3	SMA Series	48
M39012/83-3008	872-37-3	SMA Series	48
M39012/93-3001	877-86-1	SMA Series	57
M39012/93-3002	877-92-1	SMA Series	57
M39012/93-3003	877-93-1	SMA Series	57
M39012/94-3001	877-87-1	SMA Series	57
M39012/94-3002	877-94-1	SMA Series	57
M39012/94-3003	877-95-1	SMA Series	57
M49142/03-0004	1995-12-5	TRB Series	82
M49142/03-0007	1995-11-5	TRB Series	82
M49142/03-0008	1995-14-5	TRB Series	82
M49142/04-0004	1994-3-5	TRB Series	83
M49142/04-0005	1994-4-5	TRB Series	83
M49142/05-0004	1992-9-5	TRB Series	83
M49142/08-0002	1945-13-5	TRT Series	85
M49142/09-0006	1942-7-5	TRT Series	85
M49142/10-0001	1944-3-5	TRT Series	85
M49142/10-0002	1944-8-5	TRT Series	85
M55339/03-00027	1209-10	N Series	40
M55339/04-00001	1209-19	N Series	40
M55339/04-00030	1209-12	N Series	40
M55339/05-00057	1209-9	N Series	40
M55339/07-00029	1209-13	N Series	40
M55339/10-00567	799-5	C Series	21
M55339/13-00001	759-9	50 Ohm BNC Series	14
M55339/13-00492	759-2	50 Ohm BNC Series	14
M55339/14-00306	759-4	50 Ohm BNC Series	15
M55339/15-00491	759-5	50 Ohm BNC Series	14
M55339/16-00914	759-1	50 Ohm BNC Series	14
M55339/17-00274	759-3	50 Ohm BNC Series	15
M55339/35-00001	129-4	TNC Series	79
M55339/50-00001	129-6	TNC Series	79

Part Number	Page
1941-6-9	85
1942-7-5	85
1944-1-9	85
1944-3-5	85
1944-8-5	85
1947-5-9	85
1960-1-9	83
1962-7-9	83
1964-1-9	83
1964-3-9	83
1965-5-9	82
1965-12-9	82
1966-6-5	82
1967-4-3	83
1992-9-5	83
1994-1-9	83
1994-3-5	83
1994-4-5	83
1994-12-9	83
1995-3-9	82
1995-11-5	82
1995-12-5	82
1998-2-9	82
1998-6-5	82
1998-8-5	83
1999-1-4	82
2024-7-9	100
2029-9-9	100
2065-1-9	101
2065-2-9	101
2065-7-9	101
2065-8-9	101
2065-10-9	101
2065-11-9	101
2430-2-16	69
2436-6-3	74
2437-4-5	77
2439-1-1	79
2439-1-6	79
2439-1-11	79
2439-1-16	79
2439-5-1	79
2439-5-6	79
2439-5-9	79
2439-5-16	79
2439-6-1	79
2439-6-6	79

Part Number	Page
2439-6-9	79
2724-2-5	83
2954-1-5	83
2971-2-1	35
2971-2-11	35
2971-2-16	35
2971-3-1	35
2971-3-6	35
2971-3-11	35
2971-3-16	35
2971-7-1	35
2971-7-6	35
2971-7-11	35
2971-7-16	35
2971-8-1	35
2971-8-6	35
2971-8-11	35
2971-8-16	35
2975-2-1	38
2975-2-6	38
2975-2-11	38
2975-2-16	38
2975-4-1	38
2975-4-6	38
2975-4-11	38
2975-4-16	38
2975-5-1	38
2975-5-6	37
2975-5-11	37
2975-5-16	37
2975-6-1	38
2975-6-6	38
2975-6-11	38
2975-6-16	38
2981-1-1	46
2981-1-6	46
2981-1-11	46
2981-1-16	46
2981-3-1	46
2981-3-6	46
2981-3-11	46
2981-3-16	46
2981-5-1	46
2981-5-6	46
2981-5-11	46
2981-5-16	46
2981-7-1	46

Part Number	Page
2981-7-6	46
2981-7-11	46
2981-7-16	46
2981-8-1	46
2981-8-6	46
2981-8-11	46
2981-8-16	46
2981-11-1	46
2981-11-6	46
2981-11-11	46
2981-11-16	46
2985-2-1	45
2985-2-6	45
2985-2-11	45
2985-2-16	45
2985-3-1	45
2985-3-6	45
2985-3-11	45
2985-3-16	45
2985-6-1	45
2985-6-6	45
2985-6-11	45
2985-6-16	45
2985-7-1	45
2985-7-6	45
2985-7-11	45
2985-7-16	45
2986-1-6	46
2986-1-16	46
2986-3-1	46
2986-3-6	46
2986-3-11	46
2986-3-16	46
2986-4-1	46
2986-4-6	46
2986-4-11	46
2986-4-16	46
3050-10-9	131
3050-11-9	131
3050-12-9	131
780270	114
780273	114
780274	114
780276	114
780280	114
780290	114
780370	114

Part Number	Page
780373	114
780374	114
780376	114
780380	114
780390	114
780570	115
780573	115
780574	115
780576	115
780580	115
780590	115
780670	115
780673	115
780674	115
780676	115
780680	115
780690	115
781273	114
783870	115
783873	115
783874	115
783876	115
783880	115
783890	115
785870	115
785873	115
785874	115
785876	115
785880	115
785890	115
1-8603	129
8605-3-9	119
8608-2-9	119
2065-E00-C7102N	103
2065-E00-C7202N	103
2065-E00-C9004N	103
512-900-0630H	62
KP-8001-001-012	111
KP-8001-002-012	111
KP-8002-002-012	111
0345-E00-C7201N	117
0345-E00-C7202N	117
034B-060-00401H	119
1064-1 QD	87
1065-1 QD	87
1065-2	87
1069-1	87

# PART NUMBER INDEX

Part Number	Page	Part Number	Page	Part Number	Page	Part Number	Page
1074-1 QD	25	1205-37-5	36	1209-19	40	125-67-5	73
1074-4	25	1205-43-5	36	1209-44-5	40	125-69-9	76
1074-5	25	1205-45-5	36	1209-74-22	40	125-80-9	77
1075-1	25	1205-47-9	38	1209-9	40	125-86-1	75
1075-13-9	25	1205-48-9	38	121-11-9	69	125-88-9	76
1075-2	25	1205-4-9	38	121-25-5	67	125-89-9	76
1079-7	25	1205-49-9	38	121-35-9	69	125-91-9	76
1200-2-5	36	1205-59-5	38	121-36-9	69	125-92-9	76
1201-12-9	35	1205-61-9	37	121-37-9	69	125-94-9	76
1201-13-9	35	1205-62-7	38	121-38-9	69	125-95-7	76
1201-14-9	35	1205-62-9	38	121-39-7	69	125-95-9	76
1201-21-9	35	1205-64-3	36	121-39-9	69	125-96-9	76
1201-22-9	35	1205-65-5	38	121-40-9	69	125-98-9	76
1201-23-9	35	1205-67-9	38	121-44-9	69	126-1-2	74
1201-24-9	35	1205-68-5	38	121-45-9	69	126-12-5	72
1201-25-9	35	1205-69-5	38	121-46-9	69	126-14-5	72
1201-6-9	35	1205-77-9	38	121-52-9	69	126-35-9	72
1201-9-5	34	1205-78-101	36	122-27-5	68	126-4-1	74
1202-15-5	33	1205-79-101	36	122-32-5	68	126-54-5	73
1202-16-5	33	120-600-0000R	43	122-3-5	68	126-55-5	73
1202-20-9	34	120-601-0000R	43	122-37-9	68	126-58-9	72
1202-21-5	34	1206-11-9	37	122-50-5	68	126-59-9	72
1202-22-5	34	1206-16-9	37	122-55-9	68	126-63-9	72
1202-23-9	34	1206-21-9	37	123-22-5	67	126-64-9	72
1202-2-5	34	1206-22-9	37	123-23-9	67	126-68-5	72
1202-25-5	34	1206-26-9	37	123-24-9	68	126-69-5	72
1202-26-9	34	1206-29-9	37	123-27-9	67	126-70-9	72
1202-35-9	34	1206-30-9	37	123-28-9	68	126-71-7	72
1203-13-9	33	1206-31-5	37	125-101-9	76	126-71-9	72
1203-14-9	33	1206-35-5	36	125-103-5	77	126-73-9	72
1203-15-9	34	1206-37-9	37	125-104-5	77	126-74-9	72
1203-16-9	33	1206-45-22	36	125-105-9	76	126-79-5	72
1203-18-5	33	1206-5-5	37	125-1-1	75	126-8-5	72
1203-19-9	33	1207-14-9	39	125-114-5	77	126-85-9	72
1203-20-9	33	1207-27-5	39	125-117-9	76	126-86-3	72
1203-21-9	33	1207-29-9	39	125-1-6	75	127-15	78
1203-23-9	33	1208-10-5	39	125-19-5	77	127-19-9	78
1203-24-9	33	1208-28-5	39	125-25-5	73	127-20-9	78
1203-4-9	33	1208-45-5	41	125-4-1	75	127-26-9	77
120-351-000R	43	1208-46-5	41	125-4-2	75	128-17-5	80
1204-12-5	39	120-900-1160R	43	125-52-1	75	128-25-5	80
1204-17-5	39	120-900-1161R	43	125-52-2	75	128-26-5	80
1204-20-9	39	120-900-2000R	43	125-52-3	75	128-30-9	77
1205-19-5	38	120-900-2400R	43	125-52-4	75	128-31-5	80
1205-30-9	38	1209-10	40	125-57-9	76	128-32-9	80
1205-31-9	38	1209-12	40	125-58-9	76	128-33-5	80
1205-35-5	36	1209-13	40	125-61-9	76	128-3-5	80

Part Number	Page
129-23-9	79
129-26-9	79
129-29-9	79
129-4	79
129-6	79
129-6 M06	79
1340-1	13
1345-3-31	13
1345-4-31	13
1385-13-9	39
1385-17-9	39
150-500-0850N	60
150-500-1410N	60
150-900-0630N	60
150-900-0631N	60
152-500-0850N	60
152-500-1410N	60
152-900-0630N	60
152-900-0631N	60
1685-2-5	94
1702-1	98
1702-2	98
1702-4-11	98
1704-1 QD	97
1704-1-11 M06	97
1704-2	97
1704-3-9	97
1705-1	98
1705-14	98
1705-16 M06	98
1705-16-11	98
1705-2	98
1705-2-1	98
1705-21-9	98
1705-3	98
1705-4	98
1707-1	98
1709-1	97
1709-1-11	97
1709-12 M06	97
1709-2	97
1709-3	97
1709-5	97
1725-1	25
1764-1	89
1764-2	89
1765-1	89

Part Number	Page
1800-10	73
1800-11	73
1800-4	73
1800-6	73
1800-7	73
1-8065-1	128
1-8065-10	128
1-8065-2	128
1-8065-3	128
1-8065-4	128
1-8065-5	128
1-8065-6	128
1-8065-7	128
1-8065-8	128
1-8065-9	128
1-8066-1	128
1-8066-10	128
1-8066-2	128
1-8066-3	128
1-8066-4	128
1-8066-5	128
1-8066-6	128
1-8066-7	128
1-8066-8	128
1-8066-9	128
1-8114-1 QD	128
1-8114-10 QD	128
1-8114-2 QD	128
1-8114-3 QD	128
1-8114-4 QD	128
1-8114-5 QD	128
1-8114-6 QD	128
1-8114-7 QD	128
1-8114-8 QD	128
1-8114-9 QD	128
1-8115-1 QD	128
1-8115-10 QD	129
1-8115-2 QD	128
1-8115-3 QD	128
1-8115-4 QD	128
1-8115-5 QD	128
1-8115-6 QD	128
1-8115-7 QD	129
1-8115-8 QD	129
1-8115-9 QD	129
1-8574-1	129
1-8574-10	129

Part Number	Page
1-8574-2	129
1-8574-3	129
1-8574-4	129
1-8574-5	129
1-8574-6	129
1-8574-7	129
1-8574-8	129
1-8574-9	129
1-8575-1 QD	129
1-8575-10 QD	129
1-8575-2 QD	129
1-8575-3 QD	129
1-8575-4 QD	129
1-8575-5 QD	129
1-8575-6 QD	129
1-8575-7 QD	129
1-8575-8 QD	129
1-8575-9 QD	129
1-8576-1 QD	129
1-8576-10 QD	129
1-8576-2 QD	129
1-8576-3 QD	129
1-8576-4 QD	129
1-8576-5 QD	129
1-8576-6 QD	129
1-8576-7 QD	129
1-8576-8 QD	129
1-8576-9 QD	129
1-8577-1 QD	129
1-8577-10 QD	129
1-8577-2 QD	129
1-8577-3 QD	129
1-8577-4 QD	129
1-8577-5 QD	129
1-8577-6 QD	129
1-8577-7 QD	129
1-8577-8 QD	129
1-8577-9 QD	129
1945-13-5	85
1945-19-102	85
1945-35-9	85
1962-2	83
1965-2	82
1965-28-5	82
1992-12-102	83
1995-14-5	82
1995-26-102	82

Part Number	Page
1996-14-5	82
2022-17-29	100
2022-18-29	100
2022-28-9	100
2022-29-9	100
2022-32-9	100
2024-16-9	100
2025-44-9	101
2025-44-9 M66	101
2025-76-9	101
2026-16-9	101
2026-17-9	101
2026-33-9	101
2026-34-9	101
2026-35-9	101
2026-35-9 M66	101
2026-36-9	101
2026-36-9 M66	101
2027-17-29	100
2029-15-9	100
2029-16-9	100
2029-17-9 QD	100
2029-20-9	100
2029-33-9	100
2065-10-9 M66	101
2065-11-9 M66	101
2065-15-9	101
2065-15-9 M66	101
2065-1-9 M66	101
2065-28-9	101
2065-2-9 M66	101
2065-29-9	101
2065-7-9 M66	101
2065-8-9 M66	101
2431-74-1	71
2431-74-11	71
2431-74-16	71
2431-74-2	71
2431-74-3	71
2431-74-4	71
2431-74-6	71
2431-76-1	70
2431-76-11	70
2431-76-16	70
2431-76-6	70
2431-78-10	67
2431-78-5	67

# PART NUMBER INDEX

Part Number	Page	Part Number	Page	Part Number	Page	Part Number	Page
2431-80-1	70	2431-91-1	71	2436-81-16	74	251-055-0025P	55
2431-80-11	70	2431-91-11	71	2436-81-2	74	251-055-0030G	55
2431-80-16	70	2431-91-6	71	2436-81-21	74	251-055-0030P	55
2431-80-20	70	2435-74-1	75	2436-81-6	74	251-055-0031G	55
2431-80-6	70	2435-74-11	75	2436-82-1	74	251-055-0031P	55
2431-81-1	70	2435-74-16	75	2436-82-10	74	251-055-0040G	52
2431-81-11	70	2435-74-3	75	2436-82-5	74	251-055-0040P	52
2431-81-16	70	2435-74-6	75	2436-83-1	74	251-055-0041G	52
2431-81-2	70	2435-77-1	74	2436-83-11	74	251-055-0041P	52
2431-81-6	70	2435-77-11	74	2436-83-16	74	251-060-0040G	57
2431-81-9	70	2435-77-16	74	2436-83-24	74	251-065-0022G	55
2431-82-1	71	2435-77-6	74	2436-83-6	74	251-065-0022P	55
2431-82-11	71	2435-81-1	75	2436-83-9	74	251-065-0023G	55
2431-82-16	71	2435-81-11	75	2436-85-1	74	251-065-0023P	55
2431-82-2	71	2435-81-16	75	2436-85-6	74	251-065-0024G	55
2431-82-5	71	2435-81-2	75	2437-2-0	78	251-065-0024P	55
2431-82-6	71	2435-81-20	75	250-500-0850G	49	251-065-0025G	55
2431-83-1	71	2435-81-5	75	250-500-0850P	49	251-065-0025P	55
2431-83-11	71	2435-81-6	75	250-500-0853G	49	251-065-0030G	55
2431-83-16	71	2435-81-9	75	250-500-0853P	49	251-065-0030P	55
2431-84-1	70	2435-82-1	75	250-500-0858G	49	251-065-0031G	55
2431-84-11	70	2435-82-6	75	250-500-0858P	49	251-065-0031P	55
2431-84-16	70	2435-83-1	75	250-500-1410G	49	251-065-0040G	52
2431-84-2	70	2435-83-11	75	250-500-1410P	49	251-065-0040P	52
2431-84-5	70	2435-83-16	75	250-500-1411G	49	251-065-0041G	52
2431-84-6	69	2435-83-6	75	250-500-1411P	49	251-065-0041P	52
2431-85-1	70	2435-84-1	75	250-500-1412G	49	251-066-0022G	55
2431-85-11	70	2435-84-11	75	250-500-1412P	49	251-066-0022P	55
2431-85-16	70	2435-84-16	75	250-500-1413G	49	251-066-0023G	55
2431-85-6	70	2435-84-3	75	250-500-1413P	49	251-066-0023P	55
2431-87-1	70	2435-84-5	75	250-500-1418G	49	251-066-0024G	55
2431-87-11	71	2435-84-6	75	250-500-1418P	49	251-066-0024P	55
2431-87-16	71	2435-87-1	75	250-900-0630G	58	251-066-0025G	55
2431-87-3	71	2435-87-11	75	250-900-0630P	58	251-066-0025P	55
2431-87-6	71	2435-87-16	75	250-900-0631G	58	251-066-0030G	55
2431-88-1	71	2435-87-6	75	250-900-0631P	58	251-066-0030P	55
2431-88-11	71	2435-88-1	75	250-900-1160G	58	251-066-0031G	55
2431-88-16	71	2435-88-11	75	250-900-1160P	58	251-066-0031P	55
2431-88-6	71	2435-88-16	75	250-900-1161G	58	251-066-0040G	52
2431-89-1	71	2435-88-6	75	250-900-1161P	58	251-066-0040P	52
2431-89-11	71	2435-89-1	75	251-055-0022G	55	251-066-0041G	52
2431-89-16	71	2435-89-11	75	251-055-0022P	55	251-066-0041P	52
2431-89-6	71	2435-89-16	75	251-055-0023G	55	251-075-0000G	57
2431-90-1	71	2435-89-6	75	251-055-0023P	55	251-075-0000P	57
2431-90-11	71	2436-80-1	74	251-055-0024G	55	251-075-0004G	57
2431-90-16	71	2436-81-1	74	251-055-0024P	55	251-075-0004P	57
2431-90-6	71	2436-81-11	74	251-055-0025G	55	251-575-0850G	48

Part Number	Page
251-575-1410G	48
251-975-0630G	51
251-975-0630P	51
251-975-0631G	51
251-975-0631P	51
251-975-1160G	51
251-975-1160P	51
251-975-1161G	51
251-975-1161P	51
252-500-0850G	49
252-500-0850P	49
252-500-1410G	49
252-500-1410P	49
252-900-0630G	53
252-900-0630P	53
252-900-0631G	53
252-900-0631P	53
252-900-1160G	53
252-900-1160P	53
252-900-1161G	53
252-900-1161P	53
253-055-0022G	54
253-055-0022P	54
253-055-0023G	54
253-055-0023P	54
253-055-0024G	54
253-055-0024P	54
253-055-0025G	54
253-055-0025P	55
253-060-0040G	57
253-065-0000G	54
253-065-0000P	54
253-065-0022G	55
253-065-0022P	55
253-065-0023G	55
253-065-0023P	54
253-065-0024G	54
253-065-0024P	54
253-065-0025G	54
253-065-0025P	54
253-066-0022G	54
253-066-0022P	54
253-066-0023G	54
253-066-0023P	54
253-066-0024G	54
253-066-0024P	54
253-066-0025G	54

Part Number	Page
253-066-0025P	54
2555-3-32	100
350-500-0850H	49
350-500-0858H	49
350-500-1410H	49
350-500-1411H	49
350-500-1412H	49
350-500-1418H	49
350-900-0630H	58
350-900-0630N	58
350-900-0631H	58
350-900-0631N	58
350-900-1160H	58
350-900-1160N	58
350-900-1161H	58
350-900-1161N	58
351-055-0040H	52
351-055-0040N	52
351-055-0041H	52
351-055-0041N	52
351-060-0040H	57
351-060-0046H	57
351-060-7540H	57
351-065-0040H	52
351-065-0040N	52
351-065-0041H	52
351-065-0041N	52
351-066-0040H	52
351-066-0040N	52
351-066-0041H	52
351-066-0041N	52
351-085-0030H	57
351-085-0040H	57
351-500-0850H	48
351-500-1410H	48
351-575-0850H	48
351-575-1410H	48
351-900-0630H	51
351-900-0630N	51
351-900-0631H	51
351-900-0631N	51
351-900-1160H	51
351-900-1160N	51
351-900-1161H	51
351-900-1161N	51
351-975-0630H	51
351-975-0630N	51

Part Number	Page
351-975-0631H	51
351-975-0631N	51
351-975-1160H	51
351-975-1160N	51
351-975-1161H	51
351-975-1161N	51
352-500-0850H	49
352-500-1410H	49
352-900-0630H	53
352-900-0630N	53
352-900-0631H	53
352-900-0631N	53
352-900-1160H	53
352-900-1160N	53
352-900-1161H	53
352-900-1161N	53
353-060-0040H	57
353-060-0046H	57
353-065-0000H	54
353-065-0000N	54
360-060-0040H	19
360-065-0040H	19
360-066-0040H	19
360-500-0850H	18
360-500-1410H	18
360-574-0850H	18
360-574-1410H	18
360-900-0630H	17
360-974-0630H	17
361-060-0040H	19
361-065-0040H	19
361-066-0040H	19
361-500-0850H	18
361-500-1410H	18
361-522-0850H	18
361-522-1410H	18
361-594-0850H	18
361-594-1410H	18
361-595-0850H	18
361-595-1410H	18
361-900-0630H	17
361-922-0630H	17
361-994-0630H	17
361-995-0630H	17
362-060-0040H	19
362-074-6040H	19
362-574-0850H	18

Part Number	Page
362-574-1410H	18
362-974-0630H	17
363-060-0040H	19
363-522-0850H	18
363-522-1410H	18
363-922-0630H	17
450-060-0046H	28
450-500-0470H	27
450-500-0850H	27
450-500-1410H	27
450-900-0360H	27
450-900-0630H	27
450-900-0631H	27
451-060-0046H	28
451-061-0040H	28
451-580-0470H	27
451-580-0850H	27
451-580-1410H	27
451-980-0360H	27
451-980-0630H	27
451-980-0631H	27
452-060-0046H	28
452-500-0470H	27
452-500-0850H	27
452-500-1410H	27
452-900-0360H	27
452-900-0630H	27
452-900-0631H	27
453-040-0046H	28
453-060-0041H	28
453-060-0046H	28
470-040-0040H	31
470-500-0470H	30
470-500-0850H	30
470-900-0360H	30
470-900-0361H	30
470-900-0630H	30
470-900-0631H	30
470-900-1000H	30
471-040-0040H	31
471-086-0040H	31
471-086-0040N	31
471-500-0470H	30
471-500-0850H	30
471-900-0360H	30
471-900-0361H	30
471-900-0630H	30

# PART NUMBER INDEX

Part Number	Page	Part Number	Page	Part Number	Page	Part Number	Page
471-900-0631H	30	511-880-0360H	62	7520-10	123	758-26-5	11
471-900-1000H	30	511-880-0360N	62	7520-9	123	758-33-9	11
472-900-0360H	30	511-880-0630H	62	752-27-9	9	758-36-101	11
472-900-0361H	30	511-880-0630N	62	752-34-5	9	758-42-3	11
472-900-0470H	30	511-880-0631H	62	754-21-5	13	758-42-9	11
472-900-0630H	30	511-880-0631N	62	755-100-5	6	758-8-5	11
472-900-0631H	30	511-980-0360H	62	755-104-9	7	759-1	14
472-900-0850H	30	511-980-0360N	62	755-112-5	7	759-2	14
472-900-1000H	30	511-980-0630H	62	755-112-9	7	759-3	15
473-040-0040H	31	511-980-0630N	62	755-114-5	7	759-4	17
473-040-0040N	31	511-980-0631H	62	755-114-9	7	759-5	14
510-060-0040H	65	511-980-0631N	62	755-115-5	7	759-9	14
510-060-0040N	65	512-060-0040H	65	755-116-5	7	7675-2	125
510-060-0047H	65	512-060-0040N	65	755-117-5	7	7675-5	125
510-060-0047N	65	512-600-0850H	63	755-118-5	7	7676-2	125
510-077-0040H	65	512-600-0850N	63	755-119-5	7	7702-1	109
510-600-0850H	63	512-600-1410H	63	755-120-5	7	7702-10	110
510-600-0850N	63	512-600-1410N	63	755-121-5	7	7702-11	110
510-600-1410H	63	512-900-0360H	62	755-122-5	7	7702-12	110
510-600-1410N	63	512-900-0360N	62	755-127-9	7	7702-13	110
510-800-0360H	62	512-900-0630N	62	755-128-9	7	7702-14	109
510-800-0360N	62	512-900-0631H	62	755-129-9	7	7702-15	110
510-800-0630H	62	512-900-0631N	62	755-63-9	7	7702-17	110
510-800-0630N	62	513-060-0040H	65	755-74-5	6	7702-2	109
510-800-0631H	62	513-060-0040N	65	755-78-9	7	7702-3	109
510-800-0631N	62	513-060-0080H	65	755-79-9	7	7702-4	110
510-900-0360H	62	513-060-0080N	65	755-86-5	6	7702-5	110
510-900-0360N	62	513-077-0040H	65	755-93-9	7	7702-6	110
510-900-0630H	62	611-1-9	69	756-10-9	8	7702-7	110
510-900-0630N	62	615-11-9	76	756-12-5	8	7702-8	110
511-060-0040H	65	7410-10 QD	105	756-16-9	8	7702-9	110
511-060-0040N	65	7410-14	105	756-18-9	8	7703-1	109
511-060-0047H	65	7410-15	105	756-19-7	8	7703-2	109
511-060-0047N	65	7410-16	105	756-21-7	8	7703-3	109
511-060-0048H	65	7410-20	105	756-6-9	8	7703-4	110
511-060-0048N	65	7475-21	125	756-9-5	8	7703-5	110
511-071-0000H	65	7475-22	125	757-15-9	12	7703-6	109
511-071-0000N	65	7510-1	105	757-29-5	12	7703-7	109
511-077-0040H	65	7510-16 QD	105	7575-13	126	7703-8	109
511-080-0000H	65	7510-21	105	7575-15	126	7703-9	109
511-080-0000N	65	7510-4	105	7575-18	126	7704-1	112
511-080-0001H	65	7510-7	105	7575-21	126	7704-2	112
511-080-0001N	65	751-10-9	10	7575-24	126	7704-3	112
511-082-0000H	65	751-11-9	10	7575-26	126	7704-4	112
511-082-0000N	65	751-20-9	10	7575-45	126	7704-5	112
511-680-0850H	63	751-22-9	10	7575-46	126	7704-6	112
511-680-1410H	63	751-26-9	10	7575-47	126	7704-7	112

Part Number	Page
7704-8	112
7704-9	112
7705-1	109
7705-2	109
7705-3	109
7705-4	109
7705-5	109
7705-6	109
7705-9	109
7706-1	109
7706-2	109
7707-1	112
7708-1	112
7708-11	112
7708-12	112
7708-2	112
7708-3	112
7708-4	112
7708-5	112
7708-6	112
7708-7	112
7708-8	112
7709-1	111
7709-2	111
7709-3	111
7709-5	111
7709-6	111
7709-8	111
7772-1	121
7772-2	121
7772-3	121
7772-4	121
7780-2	123
7780-3	123
7780-4	123
7780-5	123
7780-6	123
7780-7	123
7785-27	126
7785-29	126
7785-30	126
7785-31	126
7785-32	126
7785-4	126
7785-40	126
7785-41	126
7785-42	126

Part Number	Page
7785-5	126
7785-6	126
7785-7	126
7785-8	126
7790-2	121
7790-3	121
7790-4	121
7795-1	125
7795-11	125
7795-12	125
7795-13	125
7795-14	125
7795-15	125
7795-17	125
7795-27	125
7795-29	125
791-10-9	23
791-6-9	23
791-8-9	23
791-9-9	23
794-3-9	23
794-4-9	23
795-10-5	22
795-13-9	22
795-15-9	22
795-16-9	22
795-20-9	22
795-21-9	22
795-23-9	22
795-30-9	22
795-9-5	22
796-11-9	21
796-15-9	21
796-17-9	21
796-18-9	21
798-7-9	21
799-5	21
821-2-9	46
821-3-9	46
821-4-9	46
821-5-9	46
821-6-9	46
821-7-9	46
823-2-9	45
825-10-9	45
825-11-9	45
825-12-9	45

Part Number	Page
825-14-9	45
826-10-9	46
826-12-9	46
826-8-9	46
826-9-9	46
845-10-9	91
845-13-9	91
845-9-9	91
846-5-9	91
846-7-9	91
848-3-5	92
849-5-9	92
8600-2	119
8601-1	119
871-13	51
871-38-3	51
871-57-3	51
871-59-3	51
871-68-1	51
872-36-3	48
872-37-3	48
872-47-3	48
872-56-2	48
872-57-3	48
873-1-3	51
873-18	51
873-18-3	51
873-19-3	48
873-3-1	51
874-1	57
874-11-3	57
874-2-3	57
874-4	57
875-100-3	58
875-101-3	58
875-105-3	58
875-107-3	49
875-110-4	58
875-1-3	58
875-21-17	58
875-21-18	58
875-21-3	58
875-3-3	58
875-57-1	58
875-58-3	49
875-59-3	49
875-69-3	49

Part Number	Page
875-70-17	49
875-70-3	49
875-81-17	49
875-82-17	49
875-82-3	49
875-86-3	49
875-9 M09	58
875-91-3	58
875-92-3	58
875-9-3	58
876-49-3	49
876-60-3	49
876-61-17	49
876-62-17	49
876-62-3	49
876-64-3	53
876-72-3	53
877-114-4	57
877-120-5	55
877-86-1	57
877-87-1	57
877-92-1	57
877-93-1	57
877-94-1	57
877-95-1	57
878-2-3	48
879-1-3	55
879-1-9	55
879-2-1	55
879-2-3	55
879-3	55
879-3-3	55
K-4944	78
K-8845-012-**	107
K-8845-018-**	107
K-8845-024-**	107
K-8845-036-**	107
K-8845-048-**	107
K-8845-060-**	107
K-8845-072-**	107
K-8845-084-**	107
K-8845-096-**	107
K-8845-120-**	107
K-8846-012-**	107
K-8846-024-**	107
K-8846-036-**	107
K-8846-048-**	107



# PART NUMBER INDEX

Part Number	Page
K-8846-060-**	107
K-8846-072-**	107
K-8846-096-**	107
K-8846-120-**	107
K-8846-144-**	107
K-8846-288-**	107
KA-11-07	68
KA-19-101	68
KA-19-102	68
KA-19-110	69
KA-19-142	68
KA-19-143	69
KA-19-146	68
KA-19-151	68
KA-19-152	68
KA-19-153	68
KA-19-155	69
KA-19-156	69
KA-19-157	69
KA-19-171	68
KA-19-172	68
KA-19-176	67
KA-19-181	67
KA-19-19	68
KA-19-195 M06	69
KA-19-198 M06	69
KA-19-213 M06	69
KA-19-214	69
KA-19-216 M06	69
KA-19-25	69
KA-19-42	68
KA-19-51	69
KA-19-60	68
KA-19-83	69
KA-39-100 M06	67
KA-39-76	67
KA-39-79	67
KA-39-82	67
KA-39-85	67
KA-39-87	67
KA-39-93 M07	69
KA-51-18	73
KA-51-19	73
KA-59-103	77
KA-59-138	72
KA-59-146	73
KA-59-167	76

Part Number	Page
KA-59-18	73
KA-59-185	76
KA-59-185 MC7	76
KA-59-186	72
KA-59-188	76
KA-59-189	72
KA-59-208	72
KA-59-22	73
KA-59-220	77
KA-59-230	77
KA-59-231	77
KA-59-232	77
KA-59-235	72
KA-59-236	72
KA-59-237	72
KA-59-251	76
KA-59-260	76
KA-59-263	77
KA-59-267	73
KA-59-277	76
KA-59-279	77
KA-59-281	72
KA-59-287	77
KA-59-289	73
KA-59-29	73
KA-59-290	77
KA-59-291	77
KA-59-292	77
KA-59-295	72
KA-59-296	72
KA-59-297	72
KA-59-304	72
KA-59-318	72
KA-59-324	74
KA-59-343	73
KA-59-348	73
KA-59-353 M06	76
KA-59-375 M07	76
KA-59-391 M06	76
KA-59-392 M06	76
KA-59-406 M06	77
KA-59-435	73
KA-59-438 M06	76
KA-59-439 M06	72
KA-59-69	77
KA-59-70 M06	72
KA-59-72	72

Part Number	Page
KA-59-85 M07	73
KA-59-96	72
KA-71-02	78
KA-71-03	78
KA-71-04	78
KA-71-08	78
KA-71-09	78
KA-79-118	78
KA-79-156 M06	78
KA-79-157 M06	78
KA-79-161 MC9	78
KA-79-165 M06	78
KA-79-28	78
KA-79-39	78
KA-79-56	78
KA-79-59	78
KA-81-01	80
KA-81-02	80
KA-81-03	80
KA-81-04	80
KA-81-04 M06	80
KA-81-05	80
KA-81-07	80
KA-89-15	77
KA-89-18	80
KA-89-82	80
KA-91-02	79
KA-91-15	79
KA-91-16	79
KA-99-114 M06	79
KA-99-125 M06	79
KA-99-56	79
KA-99-65	79
KA-99-74	79
KA-99-79	79
KA-99-98	79
KC-19-02	10
KC-19-110	9
KC-19-122	9
KC-19-129	10
KC-19-138	9
KC-19-140	9
KC-19-152	9
KC-19-170	9
KC-19-175	9
KC-19-207	9
KC-19-208	9

Part Number	Page
KC-19-212	9
KC-19-239	10
KC-19-244	10
KC-19-245	10
KC-19-248	9
KC-19-249	9
KC-19-250	9
KC-19-256	10
KC-19-258	9
KC-19-261	9
KC-19-282	9
KC-19-288 M06	10
KC-19-293 M06	9
KC-19-323 M06	9
KC-19-328 M06	10
KC-19-329 M06	10
KC-19-50	9
KC-19-54	9
KC-19-93	9
KC-19-94	10
KC-39-03	11
KC-39-103	10
KC-39-105	10
KC-39-106	10
KC-39-134 M07	10
KC-39-30	11
KC-39-38	10
KC-39-45	10
KC-39-50	10
KC-39-93	10
KC-39-98	10
KC-59-107	7
KC-59-109	8
KC-59-111	6
KC-59-136	6
KC-59-141	6
KC-59-155	6
KC-59-156	6
KC-59-175	6
KC-59-184	6
KC-59-188	6
KC-59-195	7
KC-59-212	8
KC-59-220	7
KC-59-232	7
KC-59-239	6
KC-59-246	8

Part Number	Page	Part Number	Page	Part Number	Page	Part Number	Page
KC-59-248	6	KC-79-214	13	KD-19-65	23	KH-59-72	91
KC-59-248 M06	6	KC-79-215	12	KD-19-66	23	KH-59-78	91
KC-59-261	8	KC-79-237 M06	12	KD-19-67	23	KH-59-84	91
KC-59-267	7	KC-79-237 M07	12	KD-19-68	23	KH-79-15	92
KC-59-270	8	KC-79-260 M06	12	KD-19-69	23	KH-99-10	92
KC-59-280	7	KC-79-274 M06	12	KD-19-72	23	KN-19-110	34
KC-59-284	6	KC-79-302 M06	13	KD-19-73	23	KN-19-114	33
KC-59-287	8	KC-79-35	13	KD-19-93	23	KN-19-115	35
KC-59-288	6	KC-79-44 QD	13	KD-59-110	21	KN-19-118	35
KC-59-358	6	KC-79-48	13	KD-59-110 M07	21	KN-19-145	34
KC-59-383	7	KC-79-51	11	KD-59-119	22	KN-19-148	35
KC-59-408	8	KC-79-58	13	KD-59-125	22	KN-19-149	34
KC-59-418	8	KC-79-59	13	KD-59-126	21	KN-19-150	34
KC-59-419	8	KC-79-67 QD	13	KD-59-129	21	KN-19-151	34
KC-59-420	8	KC-79-74	13	KD-59-130	22	KN-19-162	35
KC-59-444	8	KC-89-103	13	KD-59-132	22	KN-19-186 M07	34
KC-59-446	7	KC-89-163	13	KD-59-133	22	KN-19-187 M07	33
KC-59-447	8	KC-89-180	11	KD-59-134	21	KN-19-195 M06	35
KC-59-482	7	KC-89-39	11	KD-59-135	22	KN-19-196 M06	34
KC-59-485	7	KC-89-42	13	KD-59-161	22	KN-19-198 M06	35
KC-59-533	8	KC-89-58	11	KD-59-164	22	KN-19-199 M06	35
KC-59-544	6	KC-89-59	11	KD-59-180 M06	22	KN-19-205 M06	35
KC-59-545	6	KC-89-64	13	KD-59-186 M06	22	KN-19-208 M06	35
KC-59-548	6	KC-89-87	11	KD-59-187 M06	21	KN-19-42	33
KC-59-577 M06	7	KC-89-88	11	KD-59-193 M06	21	KN-39-102	33
KC-59-588 M06	6	KC-89-89	11	KD-59-201 M06	22	KN-39-114 M06	33
KC-59-61	6	KC-89-92	11	KD-59-202 M06	21	KN-39-52	33
KC-59-89	6	KC-89-93	11	KD-59-26	21	KN-39-68	33
KC-59-95	7	KC-99-108 M06	15	KD-59-47	21	KN-39-72	33
KC-79-07	12	KC-99-20	15	KD-59-63	22	KN-39-75	33
KC-79-07 M06	12	KC-99-30	14	KD-59-84	21	KN-39-83	33
KC-79-105	13	KC-99-31	15	KD-79-13	23	KN-39-86	33
KC-79-106	13	KC-99-32	14	KD-79-14	23	KN-39-92	33
KC-79-107	13	KC-99-35	15	KD-79-19	23	KN-39-93	33
KC-79-108	13	KC-99-37	15	KD-89-08	21	KN-39-97	33
KC-79-108 M06	13	KC-99-38	14	KG-59-34 M06	45	KN-59-06	36
KC-79-109	12	KC-99-40	14	KG-81-02	45	KN-59-104	38
KC-79-110	13	KC-99-52	15	KH-39-11	92	KN-59-118	38
KC-79-111	13	KC-99-53	15	KH-39-12	92	KN-59-122	38
KC-79-125	12	KC-99-54	14	KH-39-25 M06	92	KN-59-132	38
KC-79-131	13	KC-99-56	14	KH-59-05	91	KN-59-148	37
KC-79-150	13	KC-99-95 M06	14	KH-59-24	91	KN-59-158	37
KC-79-155	13	KD-19-101	23	KH-59-26	91	KN-59-160	38
KC-79-168	12	KD-19-104 M06	23	KH-59-63	91	KN-59-173	36
KC-79-179	13	KD-19-105 M06	23	KH-59-64	91	KN-59-176	36
KC-79-197	13	KD-19-110	23	KH-59-65	91	KN-59-183	37
KC-79-200	13	KD-19-61	23	KH-59-66	91	KN-59-185	38

## PART NUMBER INDEX

Part Number	Page
KN-59-201	38
KN-59-202	38
KN-59-220	38
KN-59-220 M07	38
KN-59-226	36
KN-59-239	38
KN-59-242	38
KN-59-242 M06	38
KN-59-243	37
KN-59-244	37
KN-59-245	37
KN-59-247	38
KN-59-260	38
KN-59-261	37
KN-59-263	37
KN-59-263 M07	37
KN-59-264	37
KN-59-266	38
KN-59-271	36
KN-59-294	36
KN-59-295	36
KN-59-296	36
KN-59-298	36
KN-59-313 M06	37
KN-59-329 M06	38
KN-59-330 M06	38
KN-59-332 M06	37
KN-59-344 MAF	36
KN-59-361 M06	38
KN-59-48	36
KN-59-53	36
KN-59-57	36
KN-59-68	38
KN-59-92	37
KN-79-45 M06	39
KN-79-69	39
KN-79-70	39
KN-89-05	41
KN-89-12	41
KN-89-13	41
KN-89-14	41
KN-89-30	41
KN-89-31	41
KN-89-87 M07	41
KN-99-102 M06	40
KN-99-14	40
KN-99-30	40

Part Number	Page
KN-99-34	40
KN-99-34 M06	40
KN-99-44	40
KN-99-50	40
KN-99-58	40
KP-8000-060	112
KP-8000-061	112
KP-8000-062	112
KP-8000-063	112
KP-8012-767-400	109
KP-8021-767-400	110
KTH-1000	130
KTH-5000	130
KTM-5000	130
KTS-8-1	130
KTS-8-2	130
KTW-13	130
KV-59-04	94
KV-59-23	94
KV-59-26	94
KV-59-37	94
KV-59-56	94
KV-59-70	94
KV-79-11	95
KV-79-12	95
KV-79-15	95
KV-79-21	95
KV-99-45	94
KV-99-46	94
UG-1094 /U	13
UG-1095 B/U	34
UG-1104 A/U	11
UG-1186 /U	33
UG-160 C/U	33
UG-1873 /U	13
UG-27 C/U	40
UG-27 D/U	40
UG-30 E/U	40
UG-447 /U	12
UG-496 /U	92
UG-535 /U	12
UG-536 A/U	36
UG-536 B/U	36
UG-536 C/U	36
UG-556 B/U	33
UG-57 B/U	40
UG-59 E/U	91

Part Number	Page
UG-594 B/U	36
UG-943 B/U	22
UG-997 A/U	39







ISO 9001:2000 & AS9100  
FM 46160

All Winchester Electronics KINGS® brand products are manufactured under ISO 9001-2000 and AS9100 registered quality management systems.



All Winchester Electronics KINGS® brand products are in full compliance with the European Union Directive 2002/95/EC (RoHS). We are committed to continuous improvement, and are actively working to ensure restricted substances are removed from our products, or below RoHS specified limits.



Winchester Electronics KINGS® brand RF connector and patch plug products are Network Equipment – Building Systems (NEBS) Level III Certified.

While the information in this publication is believed to be accurate and reliable, all data presented is subject to change without notice. Winchester Electronics Corporation disclaims responsibility for any damages resulting from application or any incompleteness or inaccuracies in the information presented. Consult factory for specific information on the latest design specifications.

Registered Trademarks of Winchester Electronics Corporation -  
TR-4®, TR-5®, K-GRIP®, K-GRIP JR®, WEATHERPROOF K-GRIP JR®, PRE-ASSEMBLED K-GRIP®, TAPER GRIP®, SPEED-GRIP®, TRI-LOC®, ROTO-STRIP®, the KINGS® SYMBOL, and Connecting Innovation to Application®  
KINGS® and the KINGS® DESIGN are trademarks of Winchester Electronics Corporation.