

# KT33814UG

## KIT33814AEEVBE evaluation board

Rev. 3.0 — 2 October 2018

User guide

### KIT33814AEEVBE

The KIT33814AEEVBE evaluation board is an easy-to-use circuit board that allows the user to exercise all the functions of the MC33814 two cylinder small engine control IC. A PC communicates to the evaluation board through a USB/SPI Dongle (KITUSBSPIDGLEVME) connected to the PC's USB port. The NXP SPIGen (version 7.1.8) program provides the user interface to the MC33814 SPI port and allows the user to send commands to the IC and receive status from the IC.

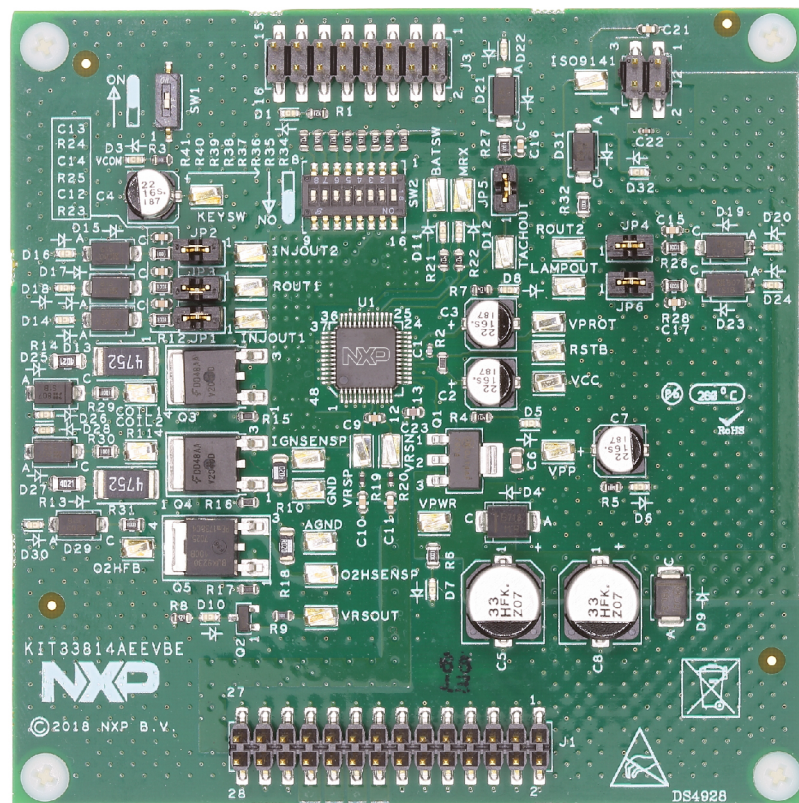

aaa-031713



## 1 Finding kit resources and information on the NXP web site

---

NXP Semiconductors provides online resources for this evaluation board and its supported device(s) on <http://www.nxp.com>.

The information page for KIT33814AEEVBE evaluation board is at <http://www.nxp.com/KIT33814AEEVBE>. The information page provides overview information, documentation, software and tools, parametrics, ordering information and a **Getting Started** tab. The **Getting Started** tab provides quick-reference information applicable to using the KIT33814AEEVBE evaluation board, including the downloadable assets referenced in this document.

### 1.1 Collaborate in the NXP community

The NXP community is for sharing ideas and tips, ask and answer technical questions, and receive input on just about any embedded design topic.

The NXP community is at <http://community.nxp.com>.

## 2 Getting ready

---

Working with the KIT33814AEEVBE requires the kit contents, additional hardware and a Windows PC workstation with installed software.

### 2.1 Kit contents

- Assembled and tested KIT33814AEEVBE board in an anti-static bag

### 2.2 Additional hardware

In addition to the kit contents, the following hardware is necessary or beneficial when working with this kit.

- Power supply 12 V with current limit set initially to 1.0 A
- Oscilloscope (4 channel preferably) with current probe
- Multimeter
- USB/SPI Dongle board (KITUSBSPIDGLEVME) plus 16-pin ribbon cable
- Typical loads (DC servo motor, fuel injectors, solenoids, lamps, relays and tachometer)

### 2.3 Windows PC workstation

This evaluation board requires a Windows PC workstation. Meeting these minimum specifications should produce great results when working with this evaluation board.

- USB-enabled computer with Windows XP or higher

### 2.4 Software

Installing software is necessary to work with this evaluation board. All listed software is available on the evaluation board's information page at <http://www.nxp.com/KIT33814AEEVBE>.

- SPI Generator (SPIGen) software, version 7.1.8 or later

## 3 Getting to know the hardware

---

The NXP analog product development boards provide an easy-to-use platform for evaluating NXP products. The boards support a range of analog, mixed-signal and power solutions. They incorporate monolithic integrated circuits and system-in-package devices that use proven high-volume technology. NXP products offer longer battery life, a smaller form factor, reduced component counts, lower cost and improved performance in powering state-of-the-art systems.

### 3.1 Kit overview

#### 3.1.1 KIT33814AEEVBE features

This evaluation board consists of a MC33814 two cylinder small engine control IC, a USB to SPI Dongle interface, and power conditioning circuitry. All +5.0 V VCC power required by the board is obtained from the MC33814 built-in power regulator. A +12 V VBAT supply provides the power to the three internal voltage regulators.

3.1.2 KIT33814AEEVBE block diagram

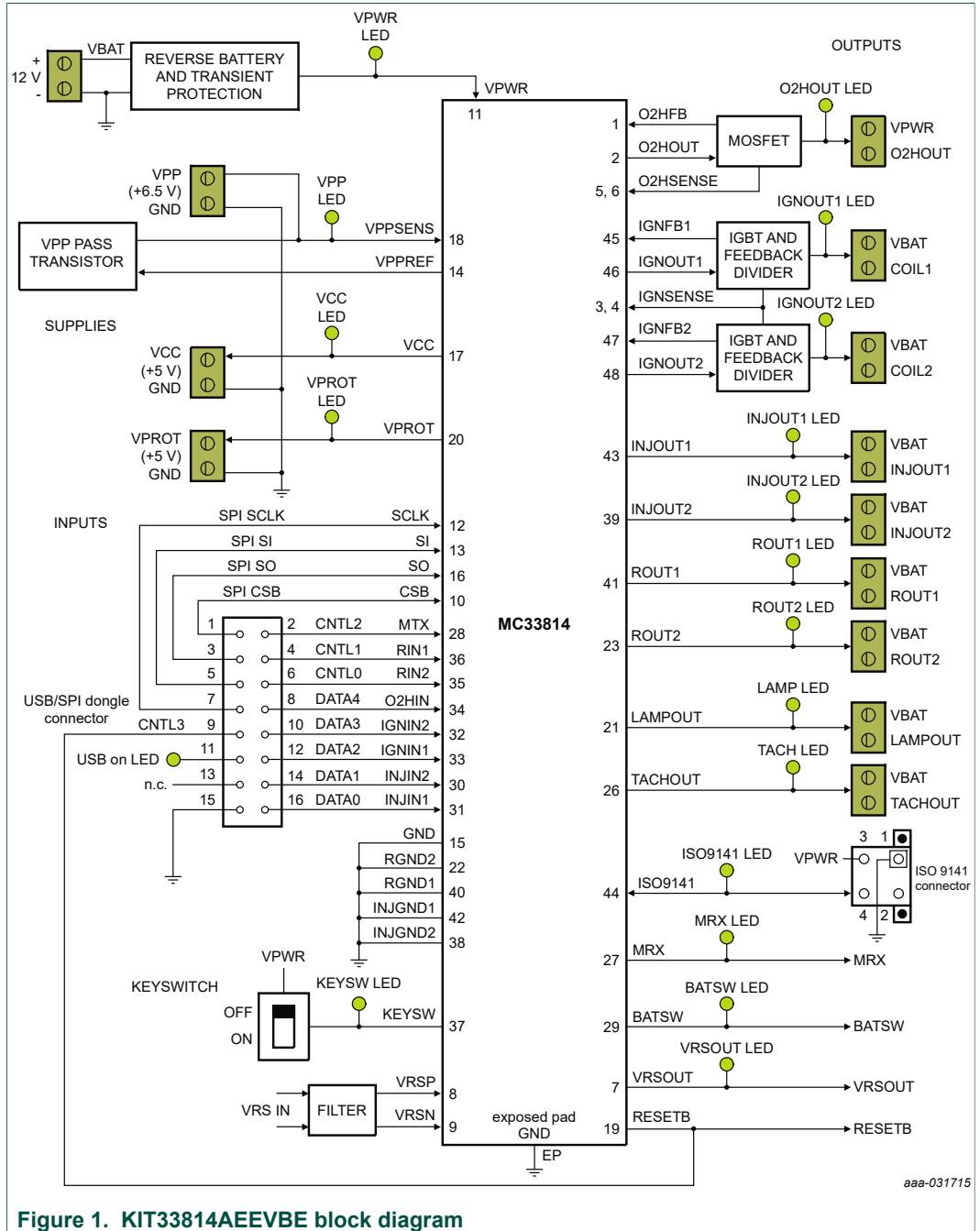

Figure 1. KIT33814AEEVBE block diagram

3.1.3 Schematic, board layout and bill of materials

The schematic, board layout and bill of materials for the KIT33814AEEVBE are available at <http://www.nxp.com/KIT33814AEEVBE>.

3.2 Featured components

Figure 2 identifies important components on the KIT33814AEEVBE board and Table 1 provides additional details on these components.

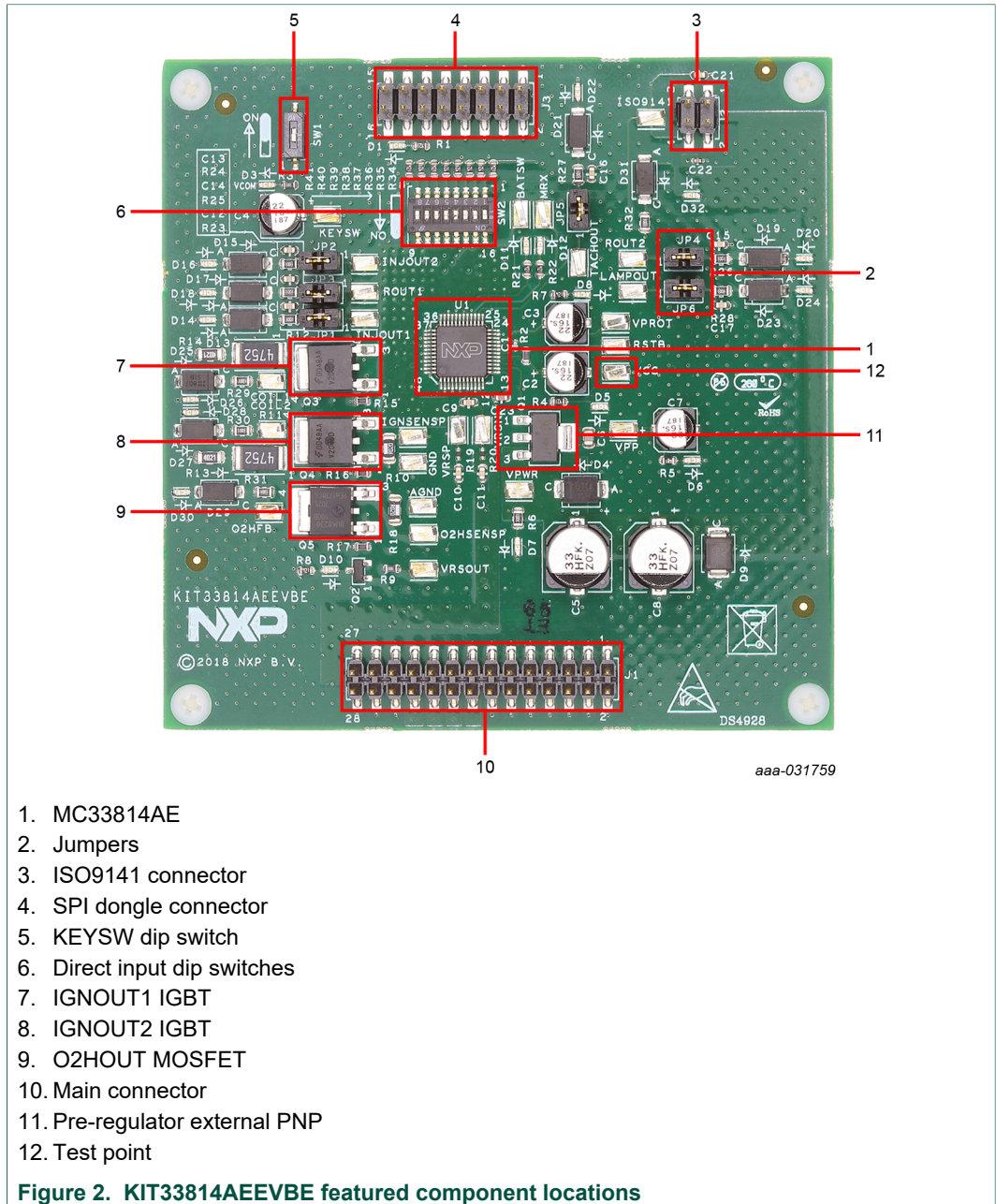

Table 1. KIT33814AEEVBE board component descriptions

Name	Description
MC33814AE	two cylinder small engine control IC
Jumpers	used to disconnect LSD from loads to experience open load functionality
ISO9141 connector	connection to K-line transceiver
SPI dongle connector	compatible with USB/SPI dongle

Name	Description
KEYSW dip switch	used to wake the device up
Direct input dip switches	when no USB/SPI is connected, direct access to LSD and predriver inputs
IGNOUT1 and IGNOUT2 IGBTs	drives an ignition coil
O2HOUT MOSFET	can drive an O2 heater sensor
Main connector	connection to Vbat, GND, external loads and VRS
Test point	to probe different signals

### 3.2.1 MC33814: Two cylinder small engine control IC

#### 3.2.1.1 General description

Powered by SMARTMOS technology, the 33814 delivers a cost-optimized IC solution for managing one and two-cylinder engines. With six drivers, three predrivers, a 5.0 V regulator for the MCU, a protected external sensor supply, and a high level of integration, the IC offers an ideal response to contemporary market requirements.

The innovative VRS system optimizes noise immunity under cranking conditions. Diagnostic and protection features present on all outputs allow applications to operate with greater safety.

#### 3.2.1.2 Features

The MC33814 is an engine control analog power IC intended for two cylinder motorcycle and other small engine control applications. The IC supports the following functionality:

- Operates over supply voltage range of  $4.5\text{ V} \leq V_{PWR} \leq 36\text{ V}$
- Logic stability guaranteed down to 2.5 V
- Two fuel injector drivers - typical of 1.3 A each
- Two Ignition IGBT or general purpose gate predrivers
- One O2 sensor (HEGO) heater general purpose gate pre-driver
- Relay 1 driver, typically 2.0 A, can be used for fuel pump control
- Relay 2 driver, typically 1.0 A, can be used as power relay control
- Lamp driver, typically 1.0 A can also be used to drive an LED
- $V_{PROT}$  protected sensor supply tracks  $V_{CC} +5.0\text{ V}$  regulator
- MCU reset generator - system integrity monitor (watchdog)
- Independent fault protection with all faults reported via the SPI
- ISO9141 K-line interface for communicating diagnostic messages
- Start-up/shutdown control and power sequence logic
- Interfaces directly to MCU using a 5.0 V SPI and logic I/O
- Differential/single-ended VRS conditioning circuit

### 3.3 Indicators

The following 19 LEDs are provided as visual output devices for the evaluation board:

**Table 2. KIT33814AEEVBE indicator descriptions**

Label	Description
VPWR	indicates when +12 V supply is connected to the evaluation board
VPP	indicates that the VPP pre-regulator is supplying +6.5 V to the two +5 V regulators, VCC and VPROT
VCC	indicates that the MC33814 internal +5 V regulator is running and providing the +5 V VCC voltage supply
VPROT	indicates that the VPROT +5 V regulator is turned ON and is supplying 5.0 V
KEYSW	indicates when the key switch is turned ON supplying +12 V to the KEYSW input
IGNOUT1	indicates that the ignition input, IGNIN1 or SPI bit, is active and the ignition 1 output driver is turned ON
IGNOUT2	indicates that the ignition input, IGNIN2 or SPI bit is active, and the ignition 2 output driver is turned ON
O2HOUT	indicates that the O2HIN input or the SPI bit is active and the O2 heater driver output is turned ON
INJOUT1	indicates that the injector 1 input, INJIN1 or SPI bit, is active and the injector 1 output is pulled low
INJOUT2	indicates that the injector 2 input, INJIN2 or SPI bit is active, and the injector 2 output is pulled low
ROUT1	indicates that the relay 1 input RIN1, or SPI bit, is active and the relay 1 output is pulled low
ROUT2	indicates that the relay 2 input RIN2, or SPI bit, is active and the relay 2 output is pulled low
LAMPOUT	indicates that the lamp SPI control bit is active and the LAMPOUT pin is pulled low
VRSOUT	indicates that there is activity on the VRSN and VRSP pins and that the VRS circuit has detected a valid VRS signal
TACHOUT	indicates the state of the TACHOUT output signal
MRX	indicates the state of the MRX line as a result of the data on the ISO9141 line
BATSW	indicates the state of the on-board key switch. When the key switch is ON, the BATSW LED is ON.
USB	indicates that the USB SPI dongle is connected properly and is attached to an active USB port on a PC
ISO9141	indicates the state of the ISO9141 line. When this LED is ON, the ISO9141 line is low and when the LED is OFF, the ISO9141 line is high.

### 3.4 Test points

The board contains 25 test point jumpers that provide access to various signals to and from the board.

**Table 3. KIT33814AEEVBE test point descriptions**

Test point name	Description
VPWR	12 V (VBAT minus Schottky diode drop)
GND	0 V
VPP	6.5 V
VCC	5.0 V
VPROT	5.0 V
BATSW	0 or 5.0 V depending on the state of KEYSW
KEYSW	0 or 12 V depending on the state of KEYSW

Test point name	Description
ISO9141	0 or 12 V depending on the state of MTX
MRX	0 or 5 V depending on the state of ISO9141 line
VRSOUT	0 or 5 V depending on the VRSN and VRSP inputs
TACHOUT	0 or 5 V depending on VRSOUT or internal SPI bits
LAMPOUT	0 or 12 V depending on the SPI bits
ROUT2	0 or 12 V depending on RIN2 or internal SPI bits
ROUT1	0 or 12 V depending on RIN1 or internal SPI bits
INJOUT2	0 or 12 volts depending on INJIN2 or internal SPI bits
INJOUT1	0 or 12 V depending on INJIN1 or internal SPI bits
COIL2	0 or 12 volts depending on IGNIN2 or internal SPI bits
COIL1	0 or 12 V depending on IGNIN1 or internal SPI bits
O2HFB	0 or 12 V depending on O2HOUT or internal SPI bits
VRSN	-0.3 to 5.0 V (clamped internally) from VRS low-side
VRSP	-0.3 to 5.0 V (clamped internally) from VRS high-side
O2HSENSN	Ground side of O2H driver current sense resistor (.02 ohms)
O2HSENSP	High-side of O2H driver current sense resistor (.02 ohms)
IGNSNSN	Ground side of IGN1/2 driver current sense resistor (.02 ohms)
IGNSNSP	High-side of IGN1/2 driver current sense resistor (.02 ohms)

### 3.5 Input signal definitions

The following eight input signals control the outputs or functions inside the circuit.

**Table 4. Input signal definitions**

Input name	Description
O2HIN	controls the O2 heater predriver output
IGNIN1	controls the ignition 1 predriver output
IGNIN2	controls the ignition 2 predriver output
INJIN1	controls the state of the INJOUT1 output
INJIN2	controls the state of the INJOUT2 output
RIN1	controls the state of the ROUT1 output
RIN2	controls the state of the ROUT2 output
MTX	provides the transmit data to the ISO9141 line

The following signals are provided by the parallel outputs from the USB/SPI interface.

**Table 5. USB/SPI direct control outputs connections**

Input name	Description
O2HIN	connected to the DATA4 signal
IGNIN1	connected to the DATA2 signal
IGNIN2	connected to the DATA3 signal
INJIN1	connected to the DATA0 signal
INJIN2	connected to the DATA1 signal



Input name	Description
RIN1	connected to the CNTL1 signal
RIN2	connected to the CNTL0 signal
MTX	connected to the CNTL2 signal

DATA0-DATA4 and CNTL0-CNTL3 signals are logic level outputs from the USB/SPI Dongle that can be controlled directly from the SPIGen program. An example SPIGEN configuration file called KIT33814SW.spi is provided in the software bundle which contains several batch file examples.

If the user prefers to supply the various MC33814 input signals externally other than from the USB-SPI interface, the dip switch SW2 can be used with the following:

- 1: not used
- 2: RIN1
- 3: RIN2
- 4: O2HIN
- 5: IGNIN2
- 6: IGNIN1
- 7: INJIN2
- 8: INJIN1

### 3.6 USB/SPI dongle connector

The USB/SPI dongle connector is a 16-pin, .1" center, dual-row connector that is designed to interface directly to the USB/SPI Dongle unit (KITUSBSPIDGLEVME). This connector mates with the 16-conductor flat cable that connects to the USB/SPI Dongle. The USB/SPI dongle connector consists of the following 16 pins.

**Table 6. USB/SPI dongle pin description**

Pin number	Name	Description
1	CNTL2	CNTL2 connected to MTX
2	CSB	SPI signal, chip select bar
3	CNTL1	CNTL1 connected to RIN1
4	SO	SPI signal, serial out
5	CNTL0	CNTL0 connected to RIN2
6	SI	SPI signal, serial In
7	DATA4	DATA4 connected to O2HIN
8	SCLK	SPI signal, serial clock
9	DATA3	DATA3 connected to IGNIN2
11	DATA2	DATA2 connected to IGNIN1
12	VDD	+5.0 V VDD from USB
13	DATA1	DATA1 connected to INJIN2
14	+3.3V	+3.3 V from USB (not used on this evaluation board)
15	DATA0	DATA0 connected to INJIN1
16	GND	Signal ground

### 3.7 Screw terminal connections

The MC33814 board contains twelve output and two input screw terminal connections and one four pin I/O connector to allow easy access to the MC33814's circuits.

Figure 3 shows the locations of the screw terminals.

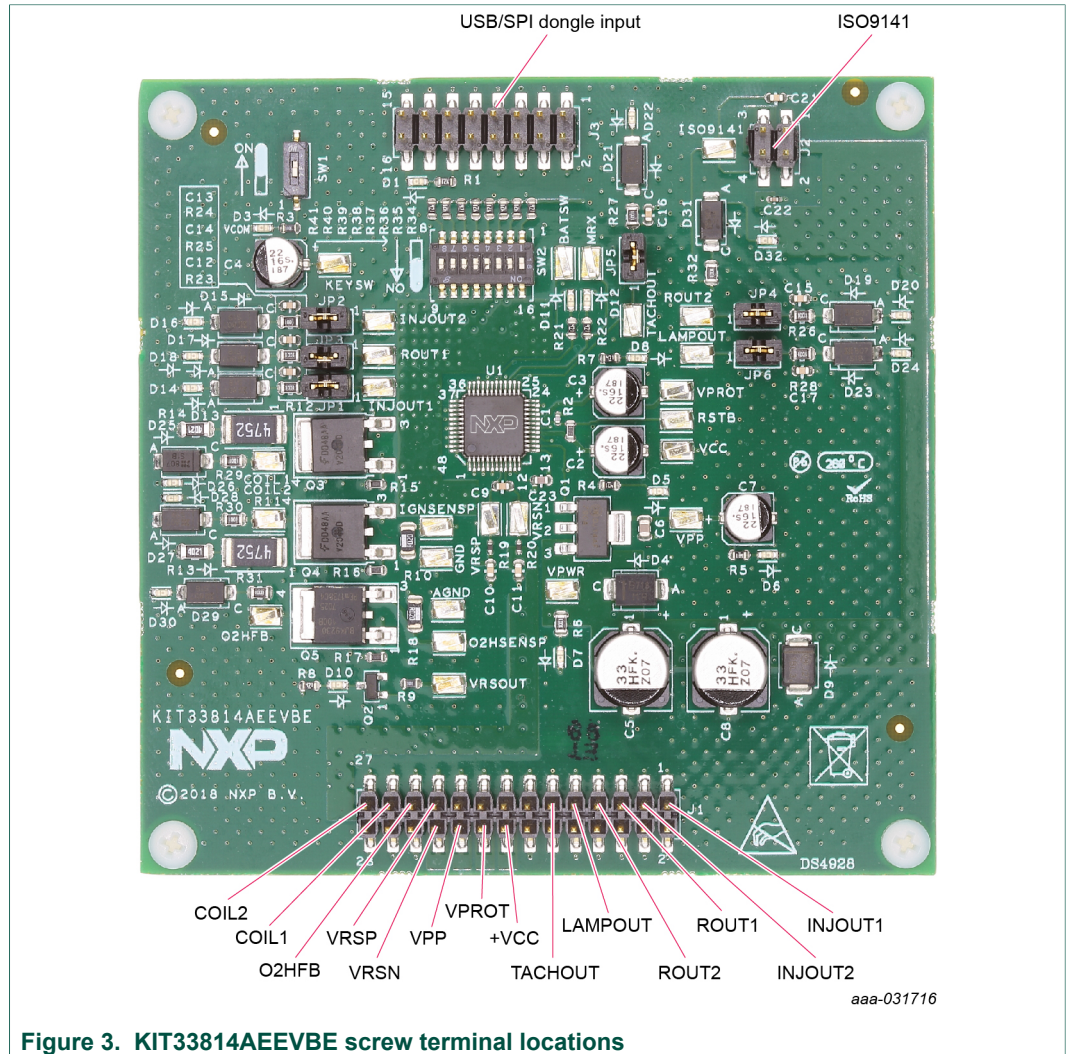

Figure 3. KIT33814AEEVBE screw terminal locations

### 3.8 Board connectors

Table 7. Main connector

Label	Pin numbers on main connector (J1)
INJOUT1	1
INJOUT2	3
ROUT1	5
ROUT2	7
LAMPOUT	9
TACHOUT	11
VBAT	2, 4, 6, 8, 10, 12, 14, 24, 26, 28

Label	Pin numbers on main connector (J1)
GND	13, 15, 17, 19
VRSP	21
O2HFB	23
COIL1	25
COIL2	27
VCC	16
VPROT	18
VPP	20
VRSN	22

Table 8. ISO9141 connector

Label	Pin numbers on ISO9141 connector (J2)
GND	1
VPWR	3
ISO9141	4

### 3.9 SPI dongle connector (J3)

Table 9. SPI dongle connector

Label	Pin numbers on USB/SPI connector (J3)
MTX	1
CSB	2
RIN1	3
SO	4
RIN2	5
SI	6
O2HIN	7
SCLK	8
IGNIN2	9
IGNIN1	11
+5V	12
INJIN2	13
INJIN1	15
GND	16

## 4 Accessory board

The KITUSBSPIDGLEVME evaluation board provides a USB to SPI interface that features the MC68HC908JW32 with Dongle. It is a working hardware/software example that allows a user to become familiar with the MC68HC908JW32 microcontroller by means of an actual useful application, a USB to SPI and USB to parallel converter.

The main function provided by this kit is to allow a PC, that may not have a parallel port, to communicate with other NXP evaluation kits, via a USB port. The USB port is a standard feature on almost every new PC. This kit makes use of the MC68HC908JW32's built-in USB, SPI and parallel ports.



Figure 4. KITUSBSPIDGLEVME evaluation kit

## 5 Installing and configuring software and tools

### 5.1 Installing SPIGen on your computer

The latest version of SPIGen supports the MC33814 and is designed to run on any Windows 10, Windows 8, or Windows 7-based operating system. To install the software, do the following:

1. Go to [www.nxp.com/SPIGen](http://www.nxp.com/SPIGen) and click **Download**.
2. When the SPIGEN: SPI Generator (SPIGen) software page appears, go to the **Lab and Test Software** section and click **Download** associated with the description of the selected environment. A wizard guides the user through the process.
3. If instructed for the SPIGen wizard to create a shortcut, a SPIGen icon appears on the desktop. By default, the SPIGen executable file is installed at **C:\Program Files (x86)\SPIGen**.

Installing the device drivers overwrites any previous SPIGen installation and replaces it with a current version containing the MC33814 drivers. However, configuration files (.spi) from the previous version remain intact.

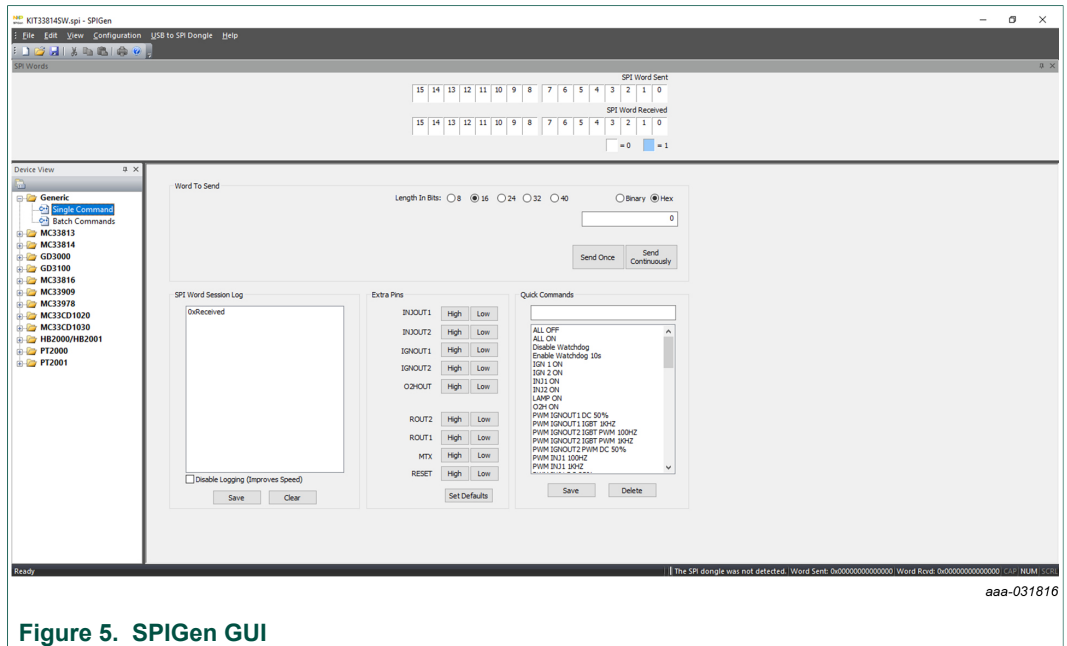
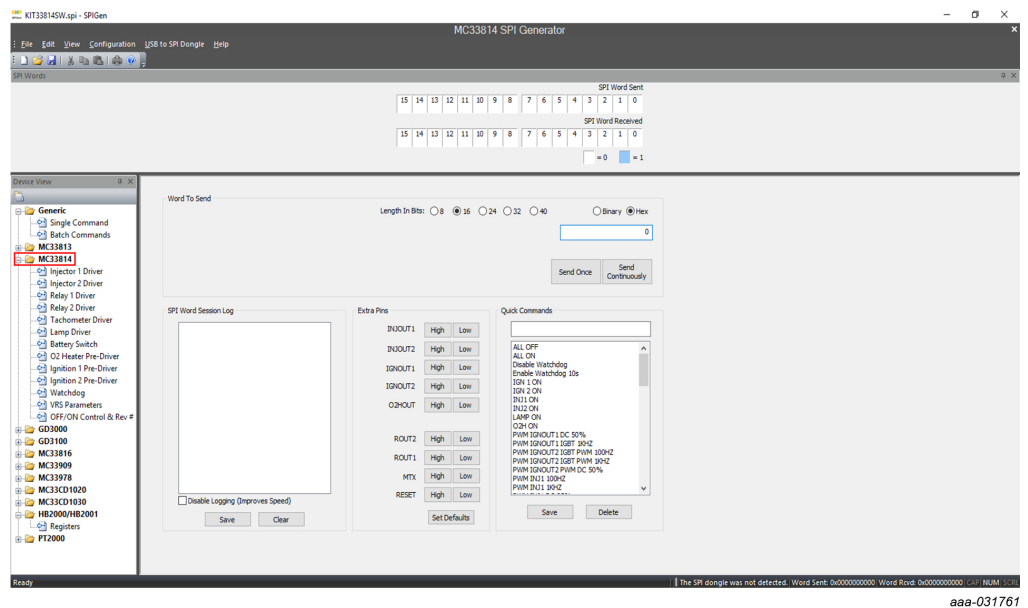

Figure 5. SPIGen GUI

The GUI is shown in [Figure 5](#). The text at the top is the name of the configuration file loaded. The left side panel displays folders that group user interfaces. The interfaces in the pre-installed MC33814 folder pertain specifically to the board under discussion. Loading a specific configuration file, allows you to add a list of **Extra Pins** as well as a list of **Quick Commands**.

## 5.2 Using SPIGen graphical user interface

1. Launch SPIGen. The MC33814 device appears in the **Device View** panel.



2. The registers can be accessed by choosing one register icon.

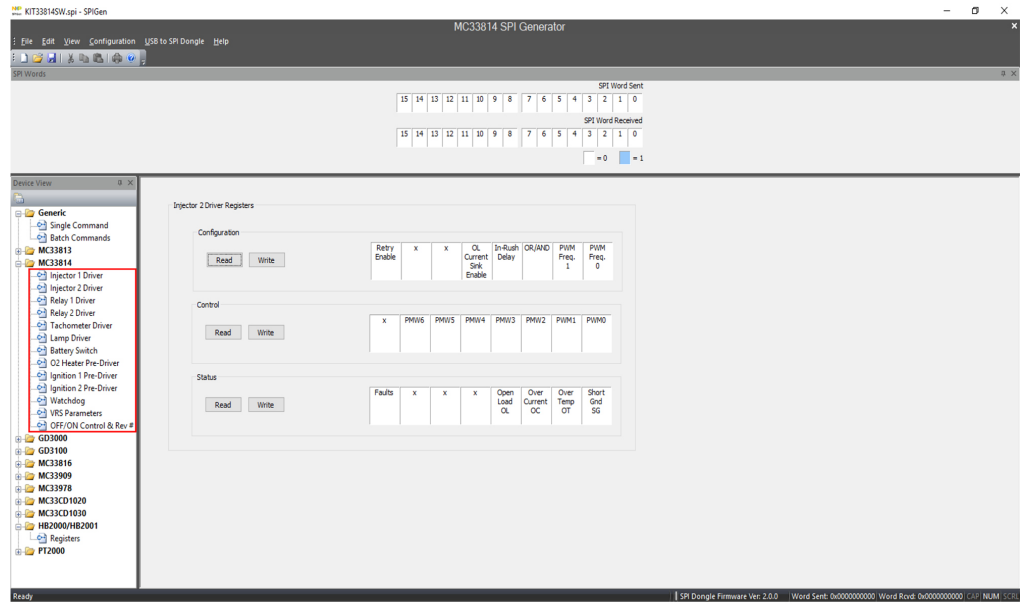

aaa-031762

3. Reading the Model Code/Revision Number displays the following values. In the same tab, the LSD, and predrivers can be switched ON and OFF through SPI.

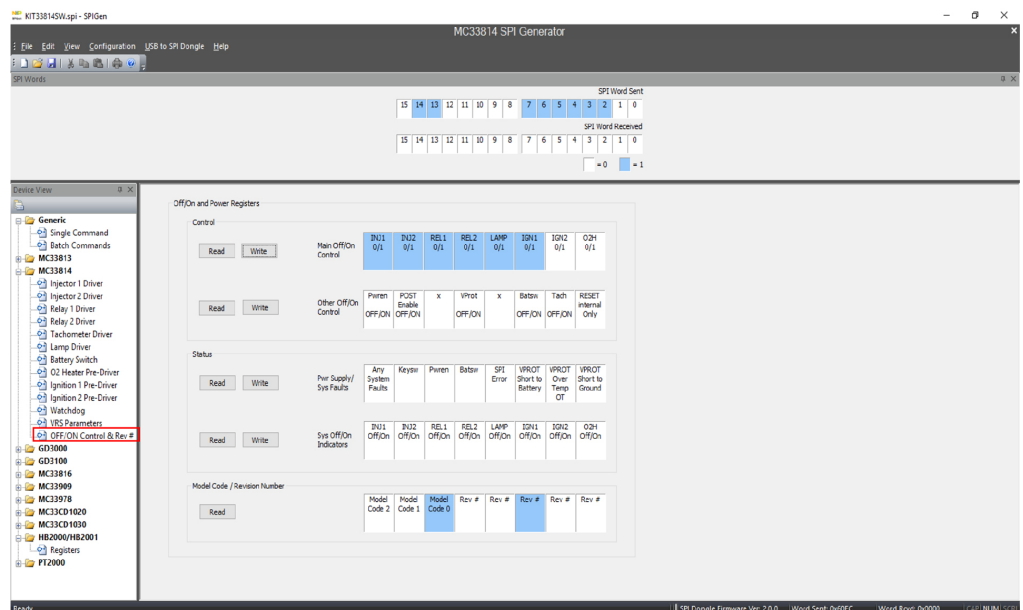

aaa-031763

## 6 Configuring the hardware

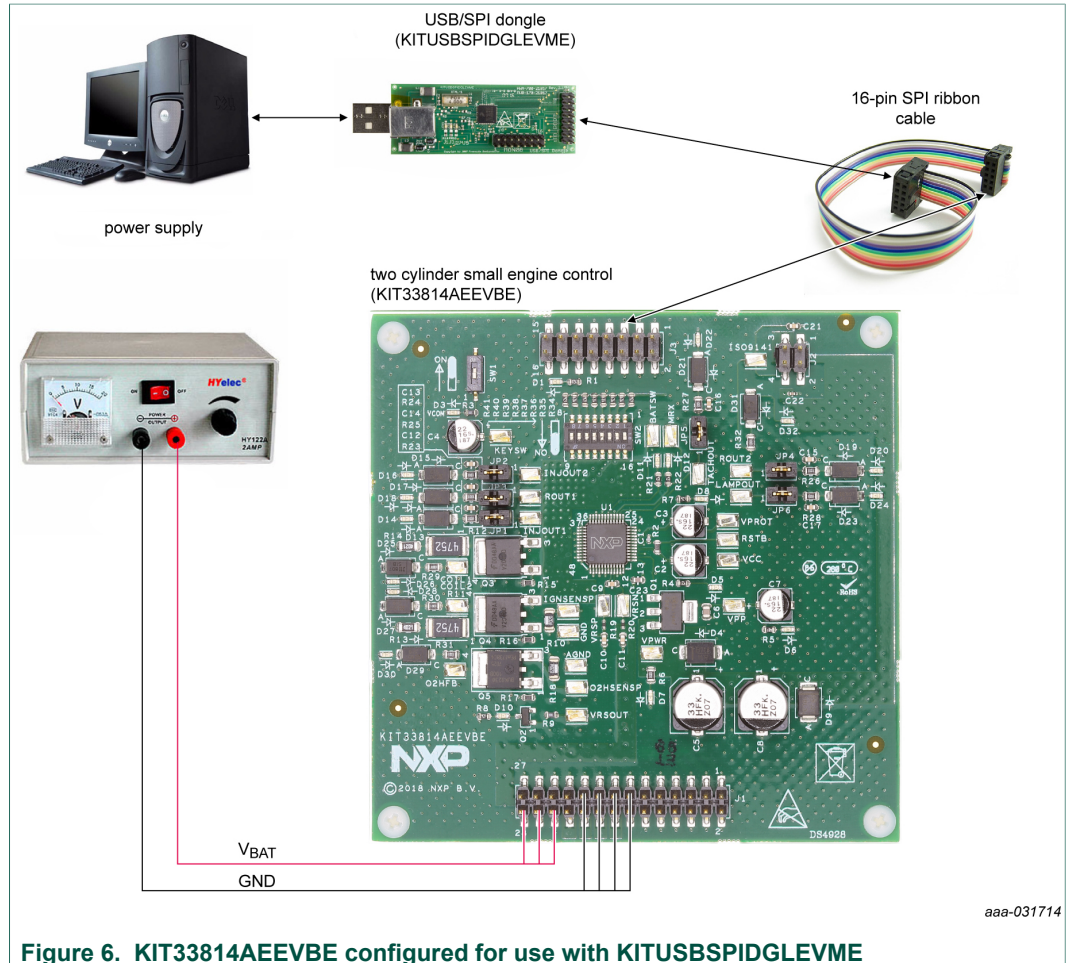

Figure 6. KIT33814AEEVBE configured for use with KITUSBSPIDGLEVME

To perform the examples included in the software bundle, the following connections and setup must be performed:

1. Make sure the SPIGen (version 7.1.8 or greater) program is installed on the PC and it can communicate with the USB/SPI Dongle.
2. Connect the USB/SPI Dongle to the MC33814 evaluation board via a 16-pin ribbon cable. Make sure to orient the cable so that pin1 on both the USB/SPI Dongle and the MC33814 evaluation board are connected correctly, pin 1 to pin 1.
3. Connect the USB/SPI Dongle to a PC, LED 2 on the USB/SPI Dongle and the USB ON LED on the MC33814 board should both be illuminated.
4. Attach a +12 VDC supply (do not turn on power yet) to the VBAT input connector on the MC33814 evaluation board, making sure to observe the GND and +12 V terminals. The current capability of the +12 V supply should exceed the maximum total current that the number of simultaneously ON loads require.
5. Attach loads to the COIL1, COIL2, O2HFB, INJOUT1, INJOUT2, ROUT1, ROUT2, LAMP, TACH and ISO9141 output terminals as desired.
6. Launch SPIGen and from the **File** menu, select **Open** and browse to the location of the **KIT33814SW.spi** file.
7. Turn on the +12 V supply and set the KEYSW slide switch to the DOWN position. Verify that all is working correctly by observing the VPWR, VPP, VCC and VPROT

LEDs which should all be illuminated. Click the **Extra Pins** button in the main SPIGen screen and then click the following buttons:

- a. Click **INJIN1 High**. The INJECTOR 1 load, INJOUT1, and LED should turn ON. Clicking **INJIN1 Low** should turn OFF the load and LED.
- b. Click **INJIN2 High**. The INJECTOR 2 load, INJOUT2, and LED should turn ON. Clicking **INJIN2 Low** should turn OFF the load and LED.
- c. Click **RIN1 High**. The RELAY 1 load, ROUT1 and LED should turn ON. Clicking **RIN1 Low** should turn OFF the RELAY 1 load, ROUT1 and LED.
- d. Click **RIN2 High**. The RELAY 2 load, ROUT2, and LED should turn ON. Clicking **RIN2 Low** button should turn OFF the RELAY 2 load, ROUT2 and LED.
- e. Click **IGNIN1 High** button. The COIL1 load and LED should turn ON. Clicking **IGNIN1 Low** should turn OFF the COIL1 load and LED.
- f. Click **IGNIN2 High** button. The COIL2 load and LED should turn ON. Clicking **IGNIN2 Low** should turn OFF the COIL2 load and LED.
- g. Click **O2HIN High** button. The O2 heater, O2HFB load and LED should turn ON. Clicking **O2HIN Low** should turn OFF the O2HFB load and LED.
- h. Click **Data 3 High** button. The LAMP load and LED should turn ON. Clicking **DATA 3 Low** should turn OFF the LAMP load and LED.
- i. Click **Data 4 High**. The ISO9141 load should turn ON. Clicking **DATA 3 Low** should turn OFF the ISO9141 load.

If everything described so far occurs, then you are ready to proceed with the remaining examples.

## 6.1 Example 1: running the example batch files

1. Click on the **Batch Commands** tab in the SPIGen main screen.
2. In the box below the Commands to Send: column is a pull-down menu containing several batch file names. One of these example batch files is labeled **TOGGLE ALL OUTPUTS**.
3. Click on this label to load it. You should see a list of commands in the **Command to Send** box.
4. Click **Continuous** and observe that the loads and LEDs attached to the MC33814 board are blinking ON and then going out in succession.

There are other demo batch examples that can be run and examined for learning how to use the evaluation board.



## 7 References

- [1] **KIT33814AEEVBE** — detailed information on this board, including documentation, downloads, and software and tools  
<http://www.nxp.com/KIT33814AEEVBE>
- [2] **MC33814** — product information on Two cylinder small engine control IC, MC33814  
<http://www.nxp.com/MC33814>
- [3] **SPIGen** — SPI generator software  
<http://www.nxp.com/SPIGEN>

## 8 Revision history

### Revision history

Rev	Date	Description
v.1	20120212	<ul style="list-style-type: none"><li>• Initial version</li></ul>
v.2	20130409	<ul style="list-style-type: none"><li>• Added Jump Start link for downloading software and/or documents</li><li>• Updated SPIGen section to match latest template</li></ul>
v.3	20181002	<ul style="list-style-type: none"><li>• The format of this document has been redesigned to comply with the new identity guidelines of NXP Semiconductors.</li><li>• Legal texts have been adapted to the new company name where appropriate.</li><li>• Added <a href="#">Section 3.9</a> and <a href="#">Section 5.2</a></li><li>• <a href="#">Section 6</a>: updated <a href="#">Figure 6</a></li><li>• <a href="#">Section 3.4</a> and <a href="#">Section 3.8</a>: updated</li><li>• <a href="#">Section 3.6</a>: updated <a href="#">Table 6</a></li><li>• <a href="#">Section 3.7</a>: updated <a href="#">Figure 3</a></li><li>• Schematic, board layout, bill of material: replaced by <a href="#">Section 3.1.3</a></li></ul>

## 9 Important notice

---

NXP provides the enclosed product(s) under the following conditions:

This evaluation kit is intended for use of ENGINEERING DEVELOPMENT OR EVALUATION PURPOSES ONLY. It is provided as a sample IC pre-soldered to a printed circuit board to make it easier to access inputs, outputs, and supply terminals. This evaluation board may be used with any development system or other source of I/O signals by simply connecting it to the host MCU or computer board via off-the-shelf cables. This evaluation board is not a Reference Design and is not intended to represent a final design recommendation for any particular application. Final device in an application will be heavily dependent on proper printed circuit board layout and heat sinking design as well as attention to supply filtering, transient suppression, and I/O signal quality.

The goods provided may not be complete in terms of required design, marketing, and or manufacturing related protective considerations, including product safety measures typically found in the end product incorporating the goods. Due to the open construction of the product, it is the user's responsibility to take any and all appropriate precautions with regard to electrostatic discharge. In order to minimize risks associated with the customers applications, adequate design and operating safeguards must be provided by the customer to minimize inherent or procedural hazards. For any safety concerns, contact NXP sales and technical support services.

Should this evaluation kit not meet the specifications indicated in the kit, it may be returned within 30 days from the date of delivery and will be replaced by a new kit.

NXP reserves the right to make changes without further notice to any products herein. NXP makes no warranty, representation or guarantee regarding the suitability of its products for any particular purpose, nor does NXP assume any liability arising out of the application or use of any product or circuit, and specifically disclaims any and all liability, including without limitation consequential or incidental damages. Typical parameters can and do vary in different applications and actual performance may vary over time. All operating parameters, including Typical, must be validated for each customer application by customer's technical experts.

NXP does not convey any license under its patent rights nor the rights of others. NXP products are not designed, intended, or authorized for use as components in systems intended for surgical implant into the body, or other applications intended to support or sustain life, or for any other application in which the failure of the NXP product could create a situation where personal injury or death may occur.

Should the Buyer purchase or use NXP products for any such unintended or unauthorized application, the Buyer shall indemnify and hold NXP and its officers, employees, subsidiaries, affiliates, and distributors harmless against all claims, costs, damages, and expenses, and reasonable attorney fees arising out of, directly or indirectly, any claim of personal injury or death associated with such unintended or unauthorized use, even if such claim alleges NXP was negligent regarding the design or manufacture of the part.

## 10 Legal information

### 10.1 Definitions

**Draft** — The document is a draft version only. The content is still under internal review and subject to formal approval, which may result in modifications or additions. NXP Semiconductors does not give any representations or warranties as to the accuracy or completeness of information included herein and shall have no liability for the consequences of use of such information.

### 10.2 Disclaimers

**Limited warranty and liability** — Information in this document is believed to be accurate and reliable. However, NXP Semiconductors does not give any representations or warranties, expressed or implied, as to the accuracy or completeness of such information and shall have no liability for the consequences of use of such information. NXP Semiconductors takes no responsibility for the content in this document if provided by an information source outside of NXP Semiconductors. In no event shall NXP Semiconductors be liable for any indirect, incidental, punitive, special or consequential damages (including - without limitation - lost profits, lost savings, business interruption, costs related to the removal or replacement of any products or rework charges) whether or not such damages are based on tort (including negligence), warranty, breach of contract or any other legal theory. Notwithstanding any damages that customer might incur for any reason whatsoever, NXP Semiconductors' aggregate and cumulative liability towards customer for the products described herein shall be limited in accordance with the Terms and conditions of commercial sale of NXP Semiconductors.

**Right to make changes** — NXP Semiconductors reserves the right to make changes to information published in this document, including without limitation specifications and product descriptions, at any time and without notice. This document supersedes and replaces all information supplied prior to the publication hereof.

**Applications** — Applications that are described herein for any of these products are for illustrative purposes only. NXP Semiconductors makes no representation or warranty that such applications will be suitable for the specified use without further testing or modification. Customers are responsible for the design and operation of their applications and products using NXP Semiconductors products, and NXP Semiconductors accepts no liability for any assistance with applications or customer product design. It is customer's sole responsibility to determine whether the NXP Semiconductors product is suitable and fit for the customer's applications and products planned, as well as for the planned application and use of customer's third party customer(s). Customers should provide appropriate design and operating safeguards to minimize the risks associated with their applications and products. NXP Semiconductors does not accept any liability related to any default, damage, costs or problem which is based on any weakness or default in the customer's applications or products, or the application or use by customer's third party customer(s). Customer is responsible for doing all necessary testing for the customer's applications and products using NXP Semiconductors products in order to avoid a default of the applications and the products or of the application or use by customer's third party customer(s). NXP does not accept any liability in this respect.

**Suitability for use in automotive applications** — This NXP Semiconductors product has been qualified for use in automotive

applications. Unless otherwise agreed in writing, the product is not designed, authorized or warranted to be suitable for use in life support, life-critical or safety-critical systems or equipment, nor in applications where failure or malfunction of an NXP Semiconductors product can reasonably be expected to result in personal injury, death or severe property or environmental damage. NXP Semiconductors and its suppliers accept no liability for inclusion and/or use of NXP Semiconductors products in such equipment or applications and therefore such inclusion and/or use is at the customer's own risk.

**Export control** — This document as well as the item(s) described herein may be subject to export control regulations. Export might require a prior authorization from competent authorities.

**Evaluation products** — This product is provided on an "as is" and "with all faults" basis for evaluation purposes only. NXP Semiconductors, its affiliates and their suppliers expressly disclaim all warranties, whether express, implied or statutory, including but not limited to the implied warranties of non-infringement, merchantability and fitness for a particular purpose. The entire risk as to the quality, or arising out of the use or performance, of this product remains with customer. In no event shall NXP Semiconductors, its affiliates or their suppliers be liable to customer for any special, indirect, consequential, punitive or incidental damages (including without limitation damages for loss of business, business interruption, loss of use, loss of data or information, and the like) arising out of the use of or inability to use the product, whether or not based on tort (including negligence), strict liability, breach of contract, breach of warranty or any other theory, even if advised of the possibility of such damages. Notwithstanding any damages that customer might incur for any reason whatsoever (including without limitation, all damages referenced above and all direct or general damages), the entire liability of NXP Semiconductors, its affiliates and their suppliers and customer's exclusive remedy for all of the foregoing shall be limited to actual damages incurred by customer based on reasonable reliance up to the greater of the amount actually paid by customer for the product or five dollars (US\$5.00). The foregoing limitations, exclusions and disclaimers shall apply to the maximum extent permitted by applicable law, even if any remedy fails of its essential purpose.

**Safety of high-voltage evaluation products** — The non-insulated high voltages that are present when operating this product, constitute a risk of electric shock, personal injury, death and/or ignition of fire. This product is intended for evaluation purposes only. It shall be operated in a designated test area by personnel that is qualified according to local requirements and labor laws to work with non-insulated mains voltages and high-voltage circuits. The product does not comply with IEC 60950 based national or regional safety standards. NXP Semiconductors does not accept any liability for damages incurred due to inappropriate use of this product or related to non-insulated high voltages. Any use of this product is at customer's own risk and liability. The customer shall fully indemnify and hold harmless NXP Semiconductors from any liability, damages and claims resulting from the use of the product.

**Translations** — A non-English (translated) version of a document is for reference only. The English version shall prevail in case of any discrepancy between the translated and English versions.

### 10.3 Trademarks

Notice: All referenced brands, product names, service names and trademarks are the property of their respective owners.

## Tables

Tab. 1.	KIT33814AEEVBE board component descriptions .....	5	Tab. 5.	USB/SPI direct control outputs connections .....	8
Tab. 2.	KIT33814AEEVBE indicator descriptions .....	7	Tab. 6.	USB/SPI dongle pin description .....	9
Tab. 3.	KIT33814AEEVBE test point descriptions .....	7	Tab. 7.	Main connector .....	10
Tab. 4.	Input signal definitions .....	8	Tab. 8.	ISO9141 connector .....	11
			Tab. 9.	SPI dongle connector .....	11

## Figures

Fig. 1.	KIT33814AEEVBE block diagram .....	4	Fig. 4.	KITUSBSPIDGLEVME evaluation kit .....	12
Fig. 2.	KIT33814AEEVBE featured component locations .....	5	Fig. 5.	SPIGen GUI .....	13
Fig. 3.	KIT33814AEEVBE screw terminal locations .....	10	Fig. 6.	KIT33814AEEVBE configured for use with KITUSBSPIDGLEVME .....	15