

UM11360

KITPF5020FRDMEVM evaluation board

Rev. 1 — 30 June 2020

User manual

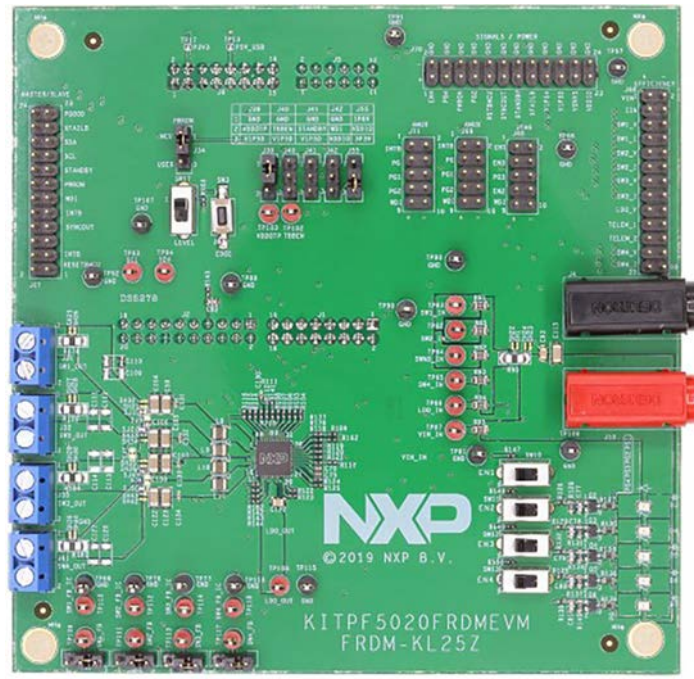

aaa-036554

Figure 1. KITPF5020FRDMEVM

Important Notice

NXP provides the enclosed product(s) under the following conditions:

This evaluation kit is intended for use of ENGINEERING DEVELOPMENT OR EVALUATION PURPOSES ONLY. It is provided as a sample IC pre-soldered to a printed circuit board to make it easier to access inputs, outputs, and supply terminals. This evaluation board may be used with any development system or other source of I/O signals by simply connecting it to the host MCU or computer board via off-the-shelf cables. This evaluation board is not a Reference Design and is not intended to represent a final design recommendation for any particular application. Final device in an application will be heavily dependent on proper printed circuit board layout and heat sinking design as well as attention to supply filtering, transient suppression, and I/O signal quality.

The goods provided may not be complete in terms of required design, marketing, and or manufacturing related protective considerations, including product safety measures typically found in the end product incorporating the goods. Due to the open construction of the product, it is the user's responsibility to take any and all appropriate precautions with regard to electrostatic discharge. In order to minimize risks associated with the customers applications, adequate design and operating safeguards must be provided by the customer to minimize inherent or procedural hazards. For any safety concerns, contact NXP sales and technical support services.

Should this evaluation kit not meet the specifications indicated in the kit, it may be returned within 30 days from the date of delivery and will be replaced by a new kit.

NXP reserves the right to make changes without further notice to any products herein. NXP makes no warranty, representation or guarantee regarding the suitability of its products for any particular purpose, nor does NXP assume any liability arising out of the application or use of any product or circuit, and specifically disclaims any and all liability, including without limitation consequential or incidental damages. Typical parameters can and do vary in different applications and actual performance may vary over time. All operating parameters, including Typical, must be validated for each customer application by customer's technical experts.

NXP does not convey any license under its patent rights nor the rights of others. NXP products are not designed, intended, or authorized for use as components in systems intended for surgical implant into the body, or other applications intended to support or sustain life, or for any other application in which the failure of the NXP product could create a situation where personal injury or death may occur.

Should the Buyer purchase or use NXP products for any such unintended or unauthorized application, the Buyer shall indemnify and hold NXP and its officers, employees, subsidiaries, affiliates, and distributors harmless against all claims, costs, damages, and expenses, and reasonable attorney fees arising out of, directly or indirectly, any claim of personal injury or death associated with such unintended or unauthorized use, even if such claim alleges NXP was negligent regarding the design or manufacture of the part.

1 Introduction

This document is the user guide for the KITPF5020FRDMEVM evaluation board. This document is intended for the engineers involved in the evaluation, design, implementation, and validation of PF5020 Power management integrated circuit (PMIC) for high performance applications.

The scope of this document is to provide the user with information that covers interfacing with the hardware, installing the GUI software, using other tools, and configuring the board for the application environment.

2 Finding kit resources and information on the NXP web site

NXP Semiconductors provides online resources for this evaluation board and its supported device(s) on <http://www.nxp.com>.

The information page for KITPF5020FRDMEVM evaluation board is at <http://www.nxp.com/KITPF5020FRDMEVM>. The information page provides overview information, documentation, software and tools, parametrics, ordering information and a **Getting Started** tab. The **Getting Started** tab provides quick-reference information applicable to using the KITPF5020FRDMEVM evaluation board, including the downloadable assets referenced in this document.

2.1 Collaborate in the NXP community

The NXP community is for sharing ideas and tips, ask and answer technical questions, and receive input on just about any embedded design topic.

The NXP community is at <http://community.nxp.com>.

3 Getting ready

Working with the KITPF5020FRDMEVM requires the kit contents, additional hardware and a Windows PC workstation with installed software.

3.1 Kit contents

- Assembled and tested KITPF5020FRDMEVM connected to FRDM-KL25Z in an anti-static bag
- 3.0 ft USB-STD A to USB-B-mini cable

3.2 Additional hardware

In addition to the kit contents, the following hardware is necessary or beneficial when working with this kit.

- Power supply with a range of 2.5 V to 6.0 V and current limit set initially to 100 mA

3.3 Windows PC workstation

This evaluation board requires a Windows PC workstation. Meeting these minimum specifications should produce great results when working with this evaluation board.

- USB-enabled computer with Windows 7 or Windows 10

3.4 Software

Installing software is necessary to work with this evaluation board. All listed software is available on the evaluation board's information page at <http://www.nxp.com/KITPF5020FRDMEVM>.

- **NXP_GUI_PR_1.0**: software interface GUI, tool to configure OTP, generate TBB and OTP scripts

4 Getting to know the hardware

The KITPF5020FRDMEVM evaluation board is the complete evaluation kit of the PF5020 power management IC from NXP Semiconductors. This user guide describes the functionality of the evaluation board, explains how to use the PMIC device in an application environment, and gives details about the hardware and software required.

The KITPF5020FRDMEVM board is the dedicated kit for the PF5020 PMIC but it is also compatible with other PMIC devices in the family like the PF5023 and PF5024.

4.1 KITPF5020FRDMEVM features

- SW1, SW2 in single-phase mode (default) or multiphase mode up to 3.5 A peak each
- SWND1 up to 3.5 A peak
- LDO1 from 1.5 V to 5.0 V, up to 400 mA
- PWRON switch for global wake up or enable
- Individual enable control switch for each regulator
- LEDs to indicate individual PGOODx and global PGOOD status
- USB interface through FRDM-KL25Z for register access, TBB mode, and OTP programming
- Multiple signal connectors for easy access
- Terminal blocks and test point for all the regulators for easy testing and evaluation

4.2 Kit featured components

Figure 2 identifies important components on the board.

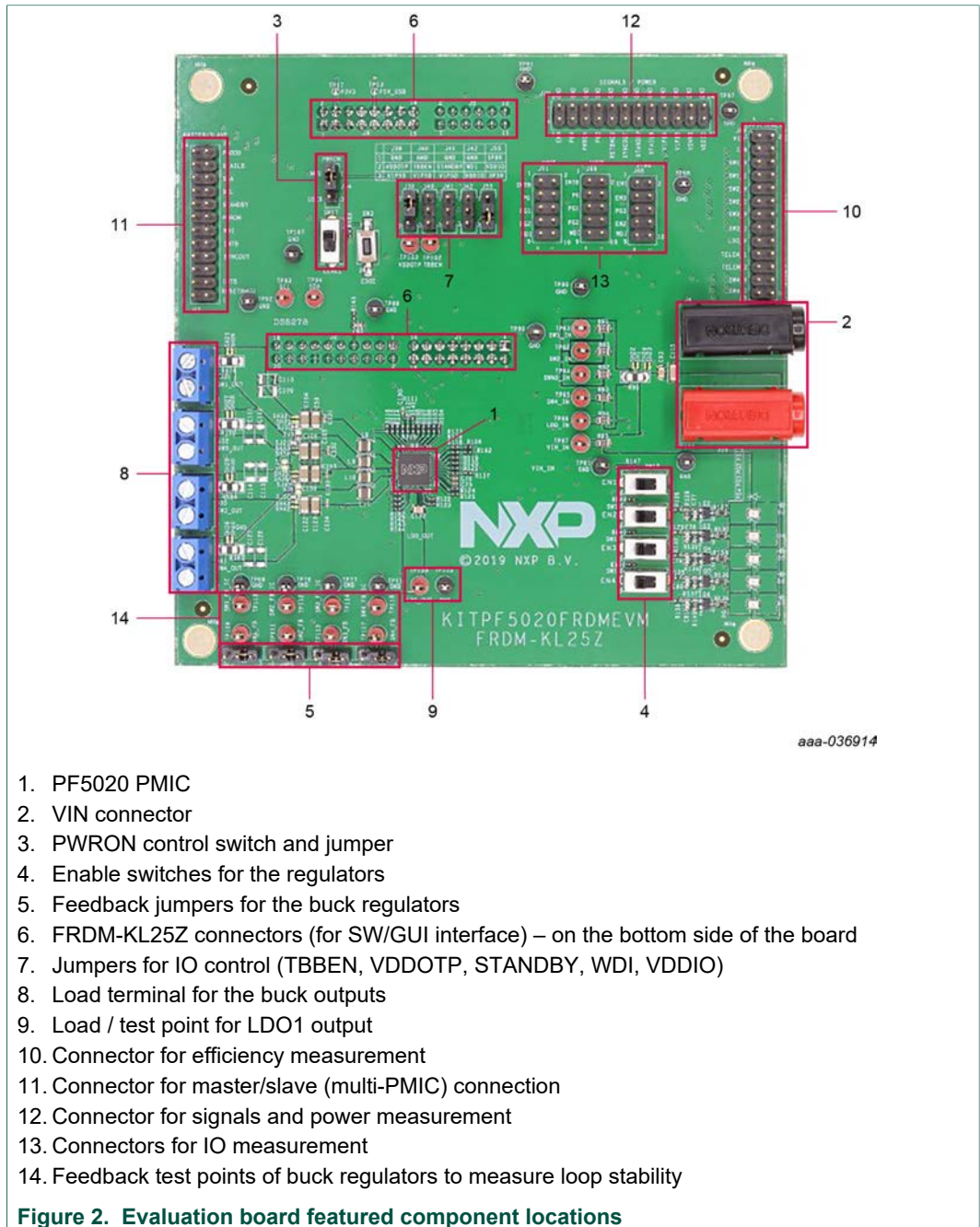

1. PF5020 PMIC
2. VIN connector
3. PWRON control switch and jumper
4. Enable switches for the regulators
5. Feedback jumpers for the buck regulators
6. FRDM-KL25Z connectors (for SW/GUI interface) – on the bottom side of the board
7. Jumpers for IO control (TBBEN, VDDOTP, STANDBY, WDI, VDDIO)
8. Load terminal for the buck outputs
9. Load / test point for LDO1 output
10. Connector for efficiency measurement
11. Connector for master/slave (multi-PMIC) connection
12. Connector for signals and power measurement
13. Connectors for IO measurement
14. Feedback test points of buck regulators to measure loop stability

Figure 2. Evaluation board featured component locations

4.2.1 PF5020: Power management integrated circuit (PMIC) for high performance applications

4.2.1.1 General description

The PF5020 integrates multiple high performance buck regulators. It can operate as a stand-alone point-of-load regulator IC, or as a companion chip to a larger PMIC.

Built-in one-time programmable (OTP) memory stores key startup configurations, drastically reducing external components typically used to set output voltage and sequence of regulators. Regulator parameters are adjustable through high-speed I2C after start up offering flexibility for different system states.

4.2.1.2 Features

- Three high efficiency buck converters
- One linear regulator with load switch options
- RTC supply and coin cell charger
- Watchdog timer/monitor
- Monitoring circuit to fit ASIL B safety level
- One-time programmable device configuration
- 3.4 MHz I²C communication interface
- 40-pin QFN package with wettable flank and exposed pad

4.2.2 Jumper, switch, and shunt configuration

Table 1. Evaluation board jumper, switch, and shunt descriptions

Jumper/switch	Default	Description
J1, J2, J5, J6	—	Freedom KL25Z board interface connectors
J34	Open	Control PWRON pull up source 2-3 → PWRON pulled up to VIN Open → full MCU control with no pull up
J39	1-2 shorted	Select PF5020 default register configuration 1-2 → OTP mode 2-3 → Hardwire mode
J40	Open	Enable TBB mode on PF5020 device 1-2 → TBB mode disabled 2-3 → TBB mode enabled Open → MCU has control of this pin
J41	Open	Select STANDBY pin voltage level 1-2 → STANDBY pin low 2-3 → STANDBY pin high Open → STANDBY pin controlled by MCU
J42	Open	Control WDI pin voltage level 1-2 → WDI pulled down to GND 2-3 → WDI pulled up to VDDIO Open → WDI controlled by the MCU
J55	2-3 shorted	Select the external LDO voltage for VDDIO 1-2 shorted → 1.8 V 2-3 shorted → 3.3 V
J62 (SW1), J63 (SW2), J64 (SWND)	2-3 Shorted	Select feedback source for SWx output 1-2 → feedback from the load 2-3 → feedback from the capacitor close to the PMIC
J66, J68, J69, J70, J71	—	Miscellaneous connectors for measurement
J67	—	Master/slave connector
SJ1 (SW1)	Short	Short → to always connect the SW1 output to load
SJ2 (SW2)	Short	Short → to connect the SW2 output in single phase to load Open → when used in multi-phase with SW1

Jumper/switch	Default	Description
SJ3 (SW12)	Open	Short → to connect SW12 in multi-phase configuration Open → when multi-phase is not used
SW3	Open	Short → Pulls down PWRON pin to ground
SW10,11,12,13 (SPDT)	Position 3	1 → ENx pulled up to VIN 2 → Open 3 → Short to GND
SW17 (SPDT)	Position 1	1 → PWRON pulled up to VIN 2 → Open 3 → Short to GND

4.3 Schematic, board layout and bill of materials

The schematic, board layout and bill of materials for the KITPF5020FRDMEVM evaluation board are available at <http://www.nxp.com/KITPF5020FRDMEVM>.

4.3.1 Schematics

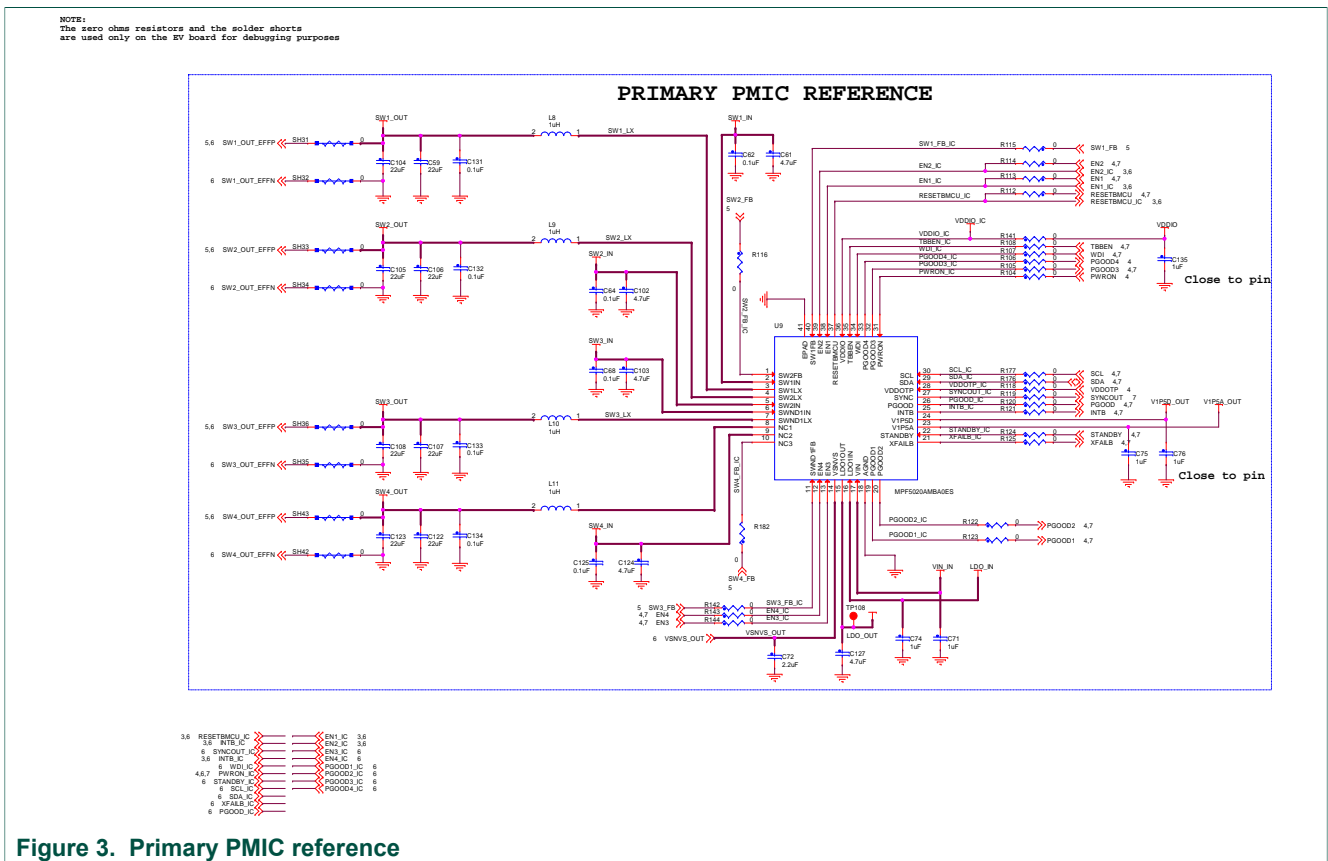

Figure 3. Primary PMIC reference

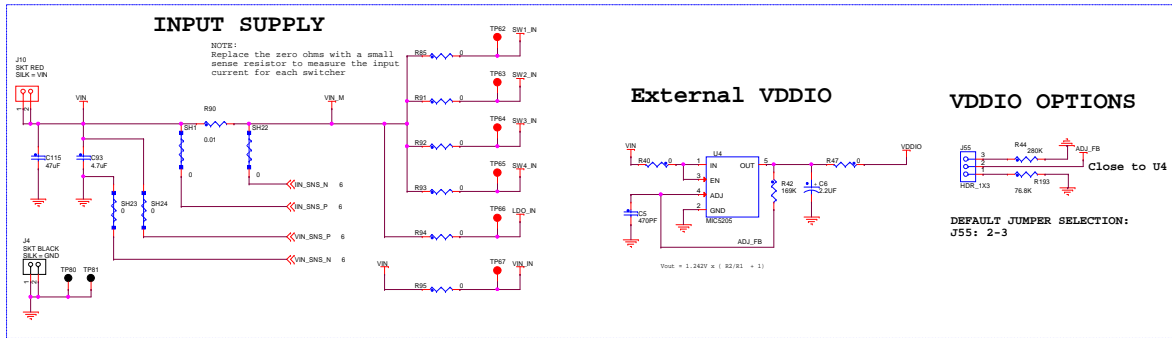

Figure 4. Power generation

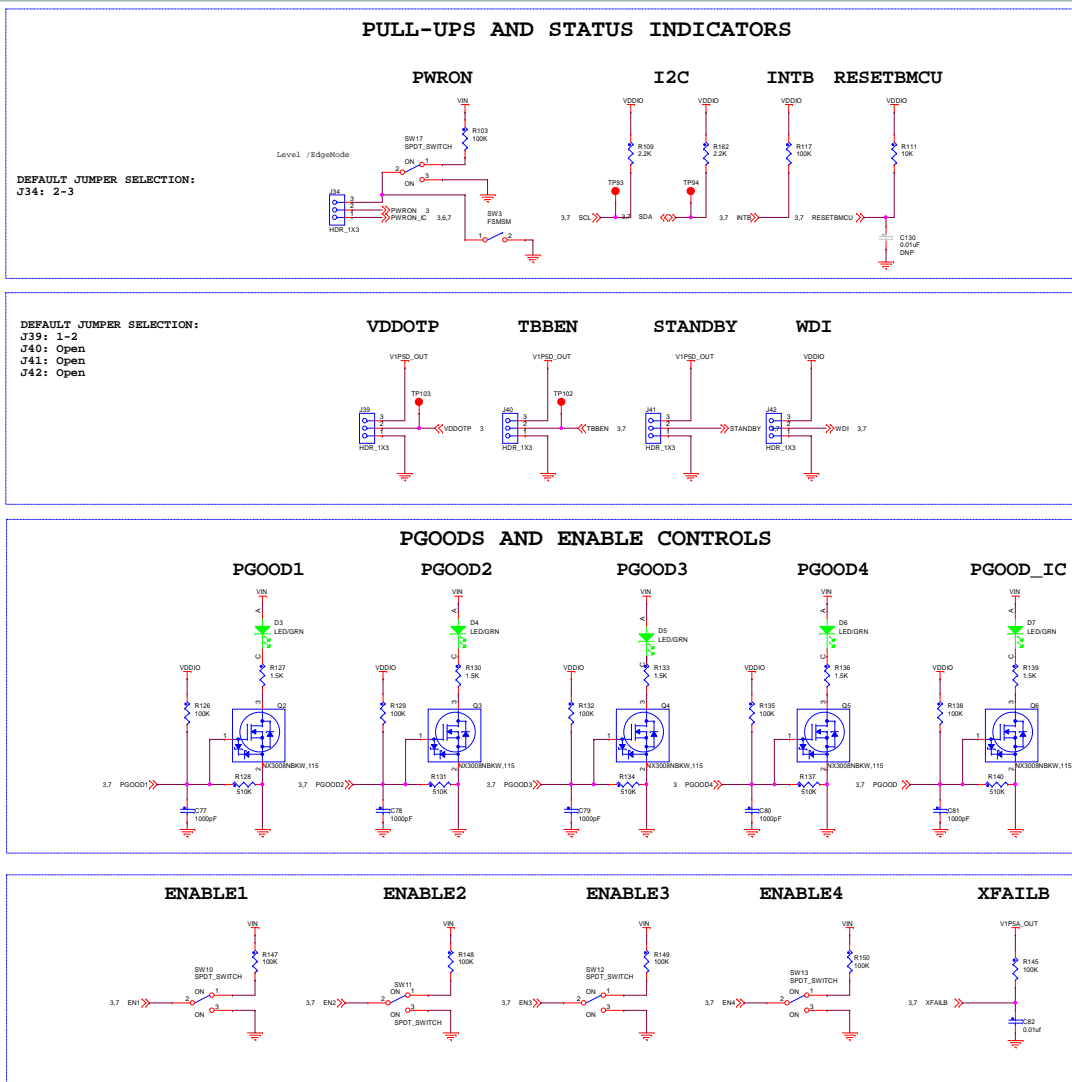

Figure 5. Pull-ups, power goods, and status indicators

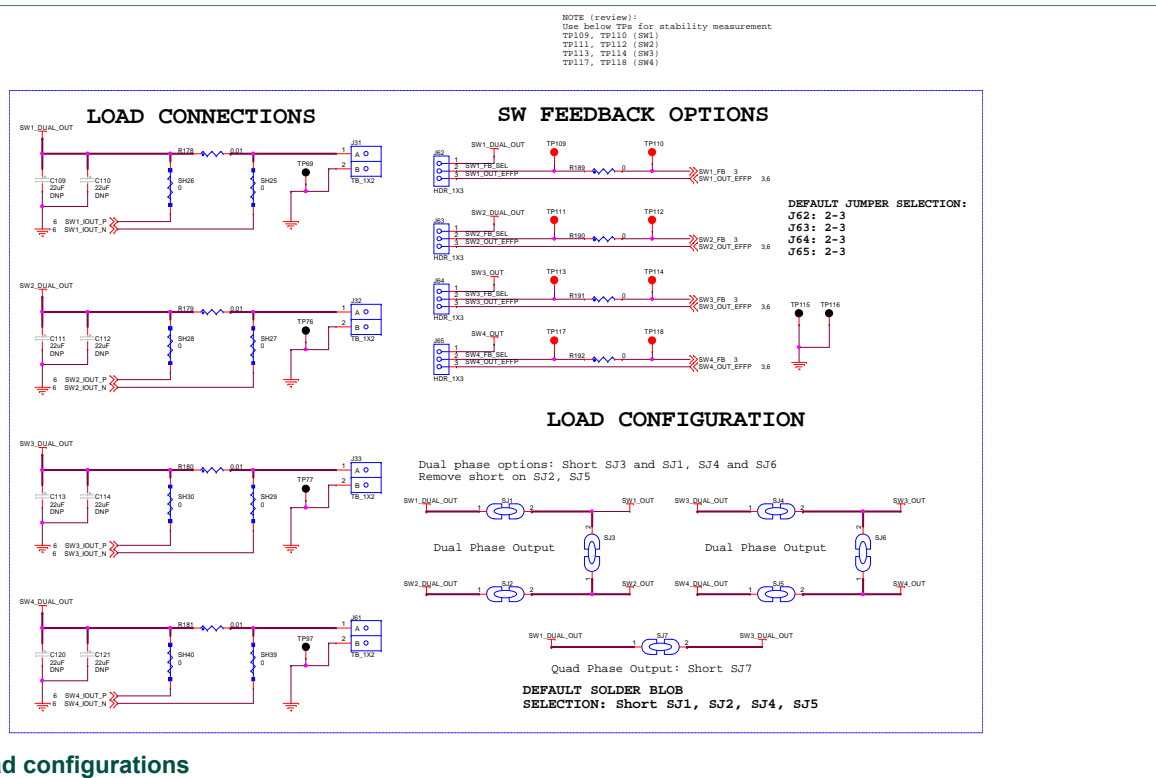

Figure 6. Load configurations

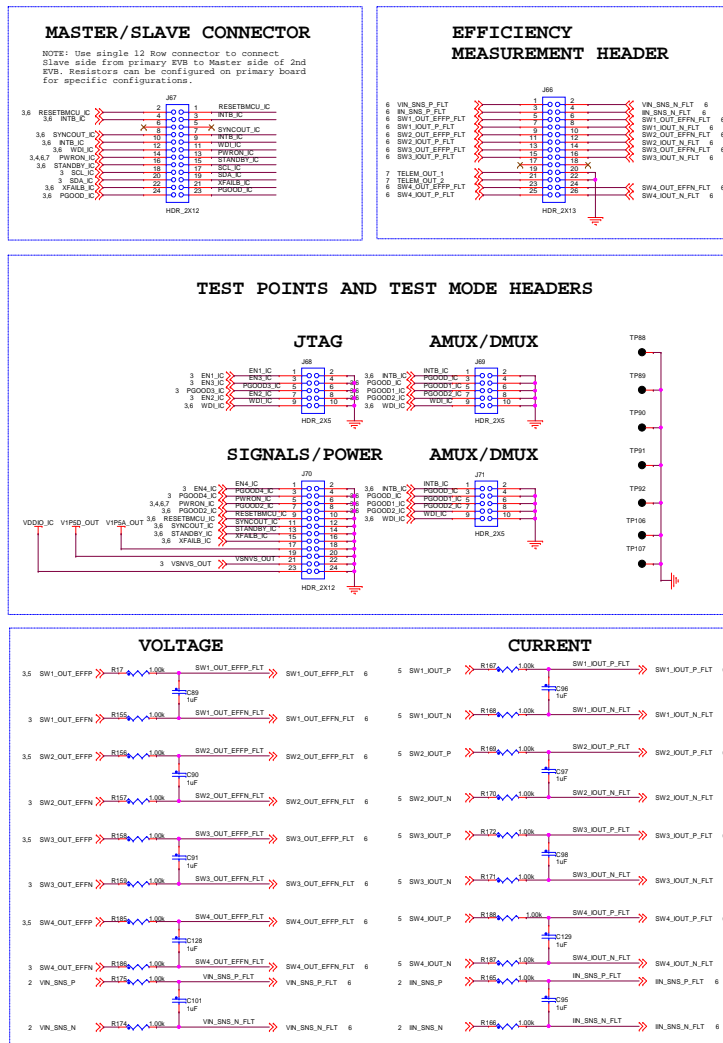

Figure 7. Signal and power measurement

Female connectors on the Freedom board
 w/13 Long pins, low insertions:
 SSG-106-23-G-D / 210-80515
 SSG-110-23-G-D / 210-80519
 SSG-108-23-G-D (x2) / 210-80247

KL25Z



Figure 8. FRDM-KL25Z interface

4.3.2 Board layout

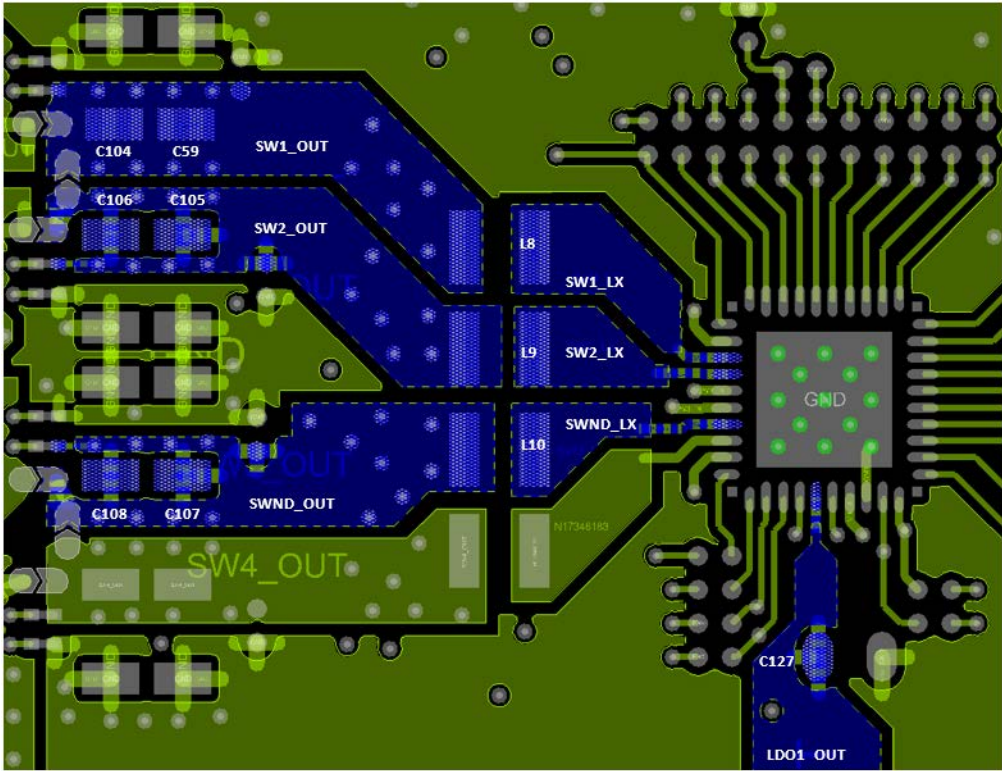

Figure 9. Top

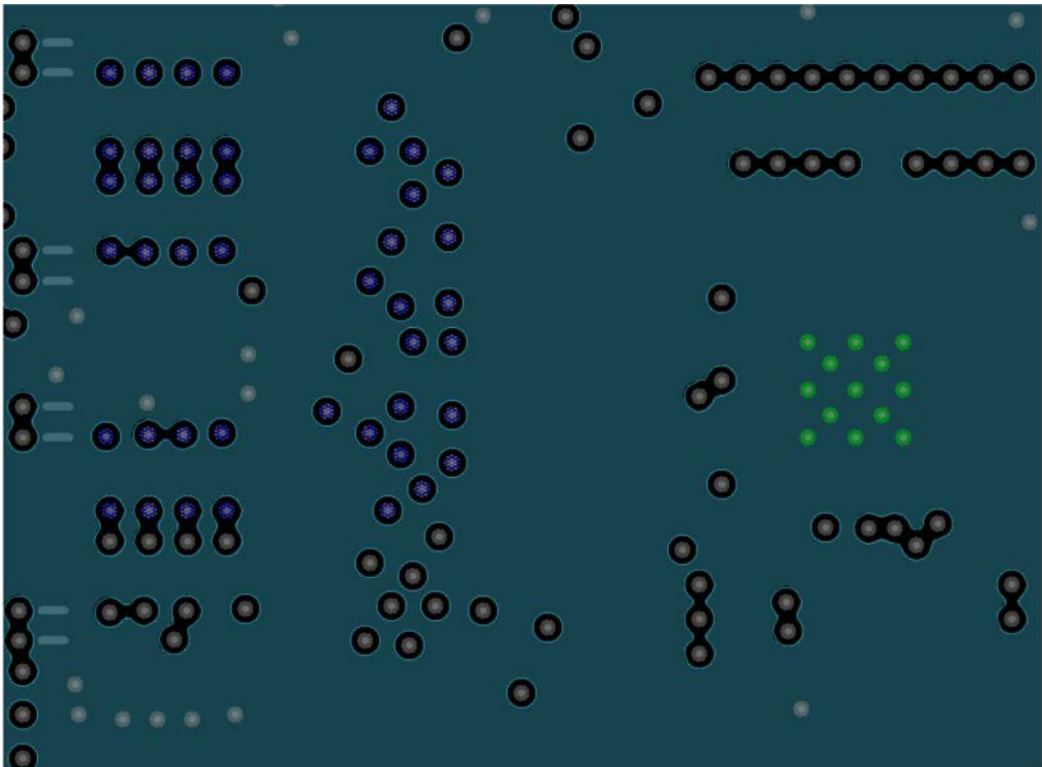

Figure 10. Layer 2

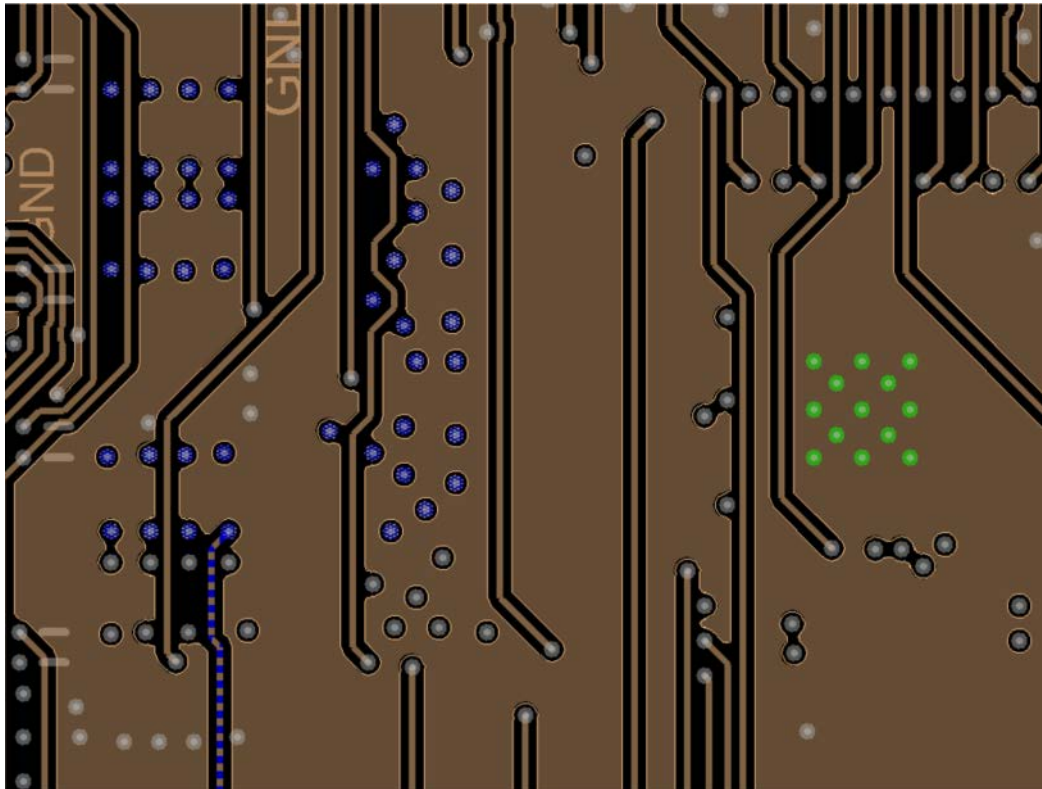

Figure 11. Layer 3

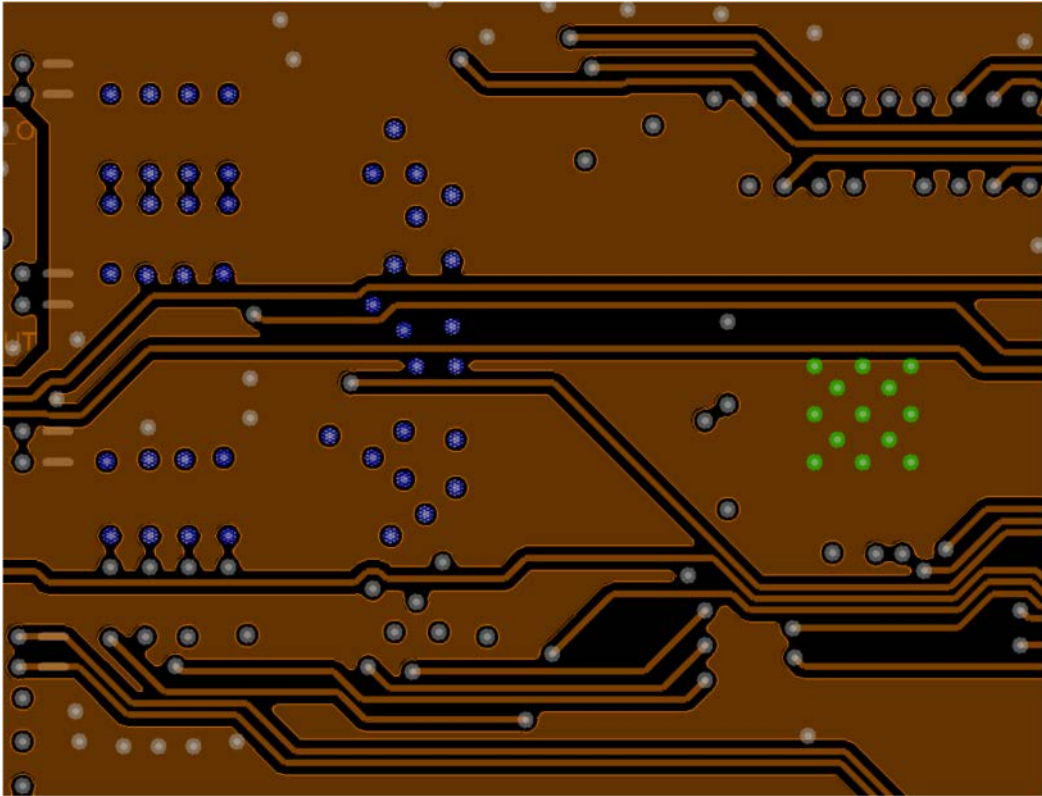

Figure 12. Layer 4

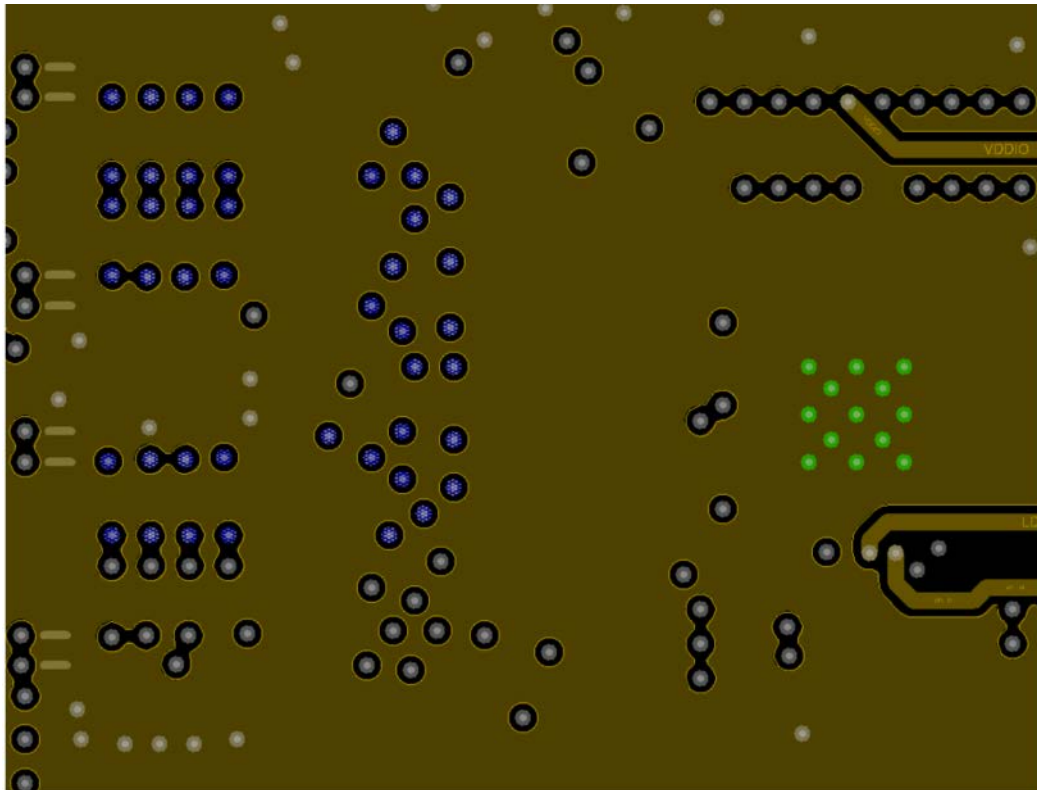

Figure 13. Layer 5

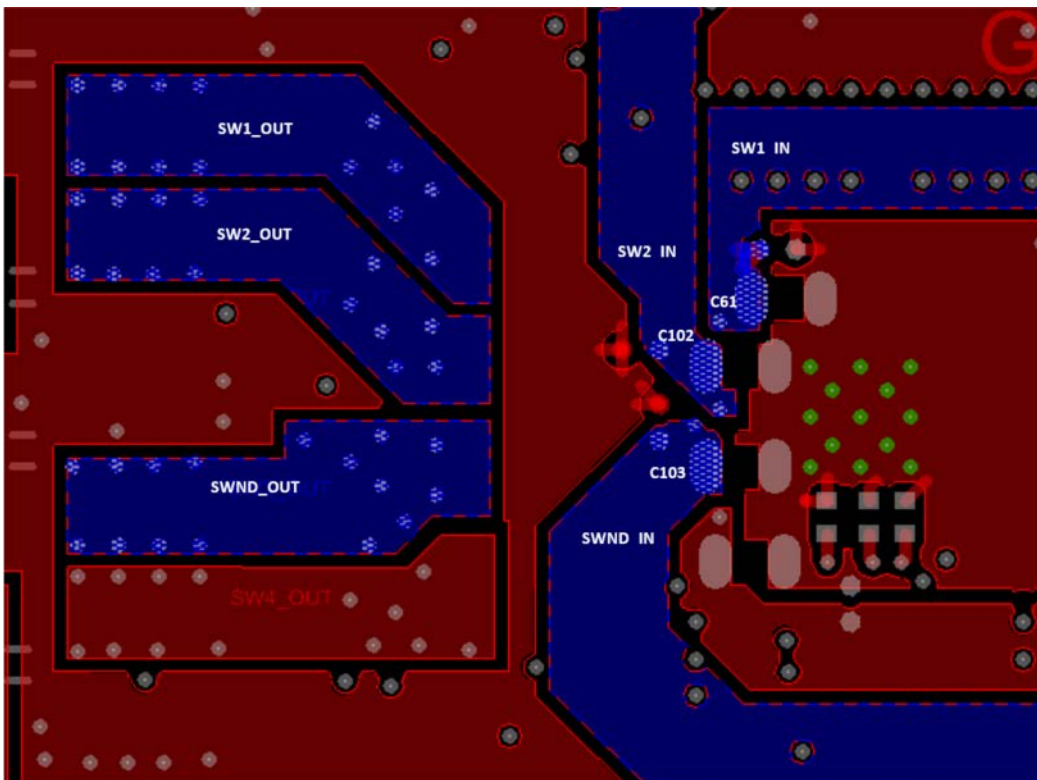

Figure 14. Bottom

4.3.3 Bill of Materials

Table 2. Bill of Materials

NXP does not assume liability, endorse, or warrant components from external manufacturers are referenced in circuit drawings or tables. While NXP offers component recommendations in this configuration, it is the customer's responsibility to validate their application.

DNP: do not populate

For critical components, it is vital to use the manufacturer listed.

Item number	Quantity	Schematic label	Value	Description	Part number	Manufacturer name	Assy Opt
Active components							
1	1	U4	MIC5205	IC LIN VREG LDO 1.5 V to 15 V 150 mA 2.5 V to 16 V SOT23-5	MIC5205YM5	MICREL	
2	1	U9	MPF5020AMBA0ES	IC POWER MANAGEMENT 5.5 V AEC-Q100 QFN40	MPF5020AMBA0ES	NXP SEMICONDUCTORS	
Capacitors							
3	1	C5	470 pF	CAP CER 470 pF 50 V 5 % COG 0603	06035A471JAT2A	AVX	
4	1	C6	2.2 µF	CAP TANT ESR = 1.800 Ω 2.2 µF 10 V 10 % 3216-18	TPSA225K010R1800	AVX	
5	16	C59, C104, C105, C106, C107, C108, C109, C110, C111, C112, C113, C114, C120, C121, C122, C123	22 µF	CAP CER 22 µF 10 V 10 % X7R AEC-Q200 1206	LMJ316B87226KLHT	Taiyo Yuden	
6	6	C61, C93, C102, C103, C124, C127	4.7 µF	CAP CER 4.7 µF 16 V 10 % X7R AEC-Q200 0805	CGA4J3X7R1C475K125AB	TDK	
7	8	C62, C64, C68, C125, C131, C132, C133, C134	0.1 µF	CAP CER 0.1 µF 16 V 10 % X7R AEC-Q200 0402	GCM155R71C104K A55D	MURATA	
8	15	C71, C74, C75, C76, C89, C90, C91, C95, C96, C97, C98, C101, C128, C129, C135	1 µF	CAP CER 1 µF 10 V 10 % X7S AEC-Q200 0402	GCM155C71A105KE 38D	MURATA	
9	1	C72	2.2 µF	CAP CER 2.2 µF 10 V 10 % X7S AEC-Q200 0402	GRT155C71A225KE 13	MURATA	
10	5	C77, C78, C79, C80, C81	1000 pF	CAP CER 1000 pF 50 V 5 % C0G AEC-Q200 0603	CGA3E2C0G1H102J 080AA	TDK	
11	1	C82	0.01 µF	CAP CER 0.01 µF 50 V 10 % X7R AEC-Q200 0603	CGA3E2X7R1H103K 080AA	TDK	
12	1	C115	47 µF	CAP CER 47 µF 10 V 20 % X5R AEC-Q200 1206	GRT31CR61A476M E13L	MURATA	
13	1	C130	0.01 µF	CAP CER 0.01 µF 50 V 10 % X7R AEC-Q200 0402			DNP
Diodes							
14	5	D3, D4, D5, D6, D7	LED/GRN	LED GRN SGL 20 mA SMT NRND	LP M67K-E2G1-25	OSRAM	
Resistors							
15	20	R17, R155, R156, R157, R158, R159, R165, R166, R167, R168, R169, R170, R171, R172, R174, R175, R185, R186, R187, R188	1.00 kΩ	RES MF 1.00 kΩ 1/16 W 1 % AEC-Q200 0402	RK73H1ETTP1001F	KOA SPEER	
16	31	R40, R47, R104, R105, R106, R107, R108, R112, R113, R114, R115, R116, R118, R119, R120, R121, R122, R123, R124, R125, R141, R142, R143, R144, R176, R177, R182, R189, R190, R191, R192	0 Ω	RES MF ZERO Ω 1/16 W -- AEC-Q200 0402	CRCW04020000Z0ED	VISHAY INTERTECHNOLOGY	
17	1	R42	169 kΩ	RES MF 169 kΩ 1/10 W 1 % AEC-Q200 0603	RK73H1JTTD1693F	KOA SPEER	
18	1	R44	280 kΩ	RES MF 280 kΩ 1/10 W 1 % AEC-Q200 0402	RK73H1ETTP2803F	KOA SPEER	
19	6	R85, R91, R92, R93, R94, R95	0 Ω	RES MF ZERO 1/8 W AEC-Q200 0805	MCR10E2P000	ROHM	
20	5	R90, R178, R179, R180, R181	0.01 Ω	RES TF 0.01 Ω 1 W 1 % AEC-Q200 1206	ERJ-8CWFR010V	PANASONIC	
21	12	R103, R117, R126, R129, R132, R135, R138, R145, R147, R148, R149, R150	100 kΩ	RES MF 100 kΩ 1 % 1/10 W AEC-Q200 0402	ERJ-2RKF1003X	PANASONIC	
22	2	R109, R162	2.2 kΩ	RES MF 2.2 kΩ 1/16 W 0.1 % AEC-Q200 0402	ERA-2AEB222X	PANASONIC	
23	5	R127, R130, R133, R136, R139	1.5 kΩ	RES MF 1.5 kΩ 1/10 W 5 % AEC-Q200 0603	ERJ3GEYJ152V	PANASONIC	
24	5	R128, R131, R134, R137, R140	510 kΩ	RES MF 510 kΩ 1/10 W 5 % 0603	RC0603JR-07510KL	YAGEO AMERICA	
25	1	R193	76.8 kΩ	RES MF 76.8 kΩ 1/10 W 1 % AEC-Q200 0402	RK73H1ETTP7682F	KOA SPEER	
26	1	R194	10 kΩ	RES MF 10 kΩ 5 % 1/10 W AEC-Q200 0402	ERJ-2GEJ103X	PANASONIC	
Switches, Connectors, Jumpers, and Test Points							
27	2	J1, J6	CON 2X8	CON 2X8 SKT TH 100 MIL SP 335H AU 104L	SSW-108-01-S-D	SAMTEC	
28	1	J2	CON_2X10	CON 2X10 SKT TH 100 MIL CTR 340H AU 104L	SSW-110-01-G-D	SAMTEC	
29	1	J4	SKT BLACK	CON 1X2 BANANA BLACK RA TH 15.3 MM SP 492H AG 197L	571-0100	DELTRON EMCON LTD	
30	1	J5	CON 2X6 SKT	CON 2X6 SKT TH 100 MIL CTR 340H AU 104L	SSW-106-01-G-D	SAMTEC	
31	1	J10	SKT RED	CON 1X2 BANANA RED RA TH 15.3MM SP 488H AG 197L	571-0500	DELTRON EMCON LTD	
32	4	J31, J32, J33, J61	TB_1X2	CON 1X2 TB TH 5 MM SP 398H SN 138L	691102710002	WURTH ELEKTRONIK EISOS GMBH & CO. KG	
33	10	J34, J39, J40, J41, J42, J55, J62, J63, J64, J65	HDR_1X3	HDR 1X3 TH 100MIL SP 330H AU 98L	HTSW-103-07-S-S	SAMTEC	

Item number	Quantity	Schematic label	Value	Description	Part number	Manufacturer name	Assy Opt
34	1	J66	HDR_2X13	HDR 2X13 TH 100 MIL CTR 330H AU	TSW-113-07-S-D	SAMTEC	
35	2	J67, J70	HDR_2X12	HDR 2X12 TH 100 MIL CTR 337H AU 100L	TSW-112-07-G-D	SAMTEC	
36	3	J68, J69, J71	HDR_2X5	HDR 2X5 TH 100MIL CTR 330H AU	TSW-105-08-G-D	SAMTEC	
37	4	L8, L9, L10, L11	1.0 µH	IND PWR 1.0 µH@1 MHz 4.7A 20 % AEC-Q200 SMD	TFM252012ALMA1R OMTAA	TDK	
38	5	Q2, Q3, Q4, Q5, Q6	NX3008NBKW,115	TRAN NMOS SW 30 V 350 mA AEC-Q101 SC-70	NX3008NBKW,115	NEXPERIA	
39	20	SH1, SH22, SH23, SH24, SH25, SH26, SH27, SH28, SH29, SH30, SH31, SH32, SH33, SH34, SH35, SH36, SH39, SH40, SH42, SH43	0	ZERO Ω CUT TRACE 0201 PADS; NO PART TO ORDER	LAYOUT ELEMENT ONLY	LAYOUT ELEMENT ONLY	
40	7	SJ1, SJ2, SJ3, SJ4, SJ5, SJ6, SJ7	0402 JUMPER	SOLDER BLOB JUMPER 0402 OPEN NO PART TO ORDER	NA	NA	
41	1	SW3	FSMSM	SW SPST PB 12 V 50 mA SMT	1437566-4	Tyco Electronics	
42	5	SW10, SW11, SW12, SW13, SW17	SPDT_SWITCH	SW SPDT SLIDE 0.1 A 12 V TH	OS102011MS2QN1	C&K Components	
43	2	TP13, TP17	TPAD_030	TEST POINT PAD 30 MIL DIA SMT, NO PART TO ORDER	NOT A COMPONENT	NOT A COMPONENT	
44	19	TP62, TP63, TP64, TP65, TP66, TP67, TP93, TP94, TP102, TP103, TP108, TP109, TP110, TP111, TP112, TP113, TP114, TP117, TP118	TESTLOOP_RED	TEST POINT PC MULTI PURPOSE RED TH	5010	KEystone ELECTRONICS	
45	15	TP69, TP76, TP77, TP80, TP81, TP88, TP89, TP90, TP91, TP92, TP97, TP106, TP107, TP115, TP116	TESTLOOP_BLACK	TEST POINT PC MULTI PURPOSE BLK TH	5011	KEystone ELECTRONICS	

5 Installing and configuring software and tools

Download and unzip the *NXP_GUI_PR_1.0* file into any desired location. The package should contain a GUI folder and MCU folder.

5.1 Freedom board BOOTLOADER refresh in a Windows 7 or 10 system (optional - only when the Freedom board is not preprogrammed)

1. Press the RST push button on the Freedom board and connect the USB cable into the SDA port on the Freedom board. A new BOOTLOADER device should appear on the left pane of the File explorer.

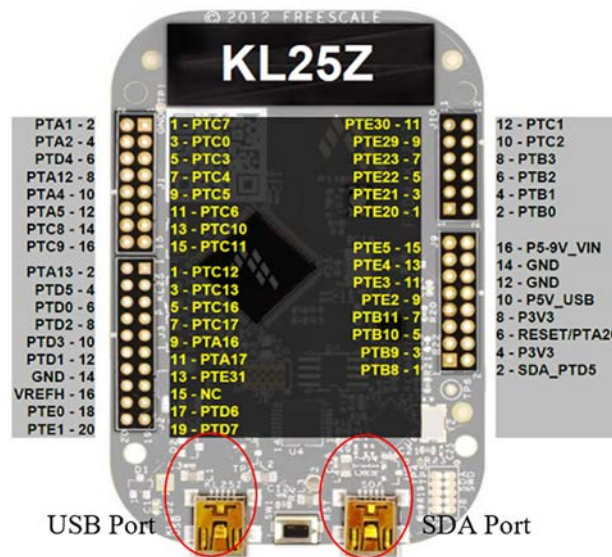

aaa-036717

2. Drag and drop the file **MSD-DEBUG-FRDM-KL25Z_Pemicro_v118.SDA** from the MCU folder into the BOOTLOADER drive.
Note: Make sure to allow enough time for the firmware to be saved in the Bootloader.
3. Disconnect and reconnect the USB cable into the SDA port (this time without pressing the RST push button). The PC installs a new device called **FRDM_KL25Z**.
4. Locate the file **nxp-gui-fw-frdmkl25z-usb_hid-pf502x_v0.1.6.bin** from the MCU folder and drag and drop the file into the FRDM_KL25Z device.
5. Freedom board firmware is successfully loaded.
6. Open and run the **NXP_GUI-1.0-Setup.exe** file from the GUI folder inside the unzipped package. This installs the NXPGUI software in the system. Install it in a local destination folder.

6 Configuring the hardware for startup

To configure the hardware and workstation, complete the following procedure:

1. With the USB cable connected to the PC and the USB port in the freedom board, apply VIN to the evaluation board.
 - a. Provide external VIN between 2.5 V to 5.5 V on J10 (VIN) and J4 (GND). Make sure that the supply is current limited to 100 mA.
2. Press **Reset** on the Freedom board, to ensure board is properly recognized.
3. If the NXPGUI application was not installed before, perform step 6 of [Section 5.1 "Freedom board BOOTLOADER refresh in a Windows 7 or 10 system \(optional - only when the Freedom board is not preprogrammed\)"](#) to install it for the first time. Open the NXPGUI application from the installation folder or from the Start menu.
4. A configuration window is displayed. Select one of the devices to load the predefined configurations, and then click **OK**.

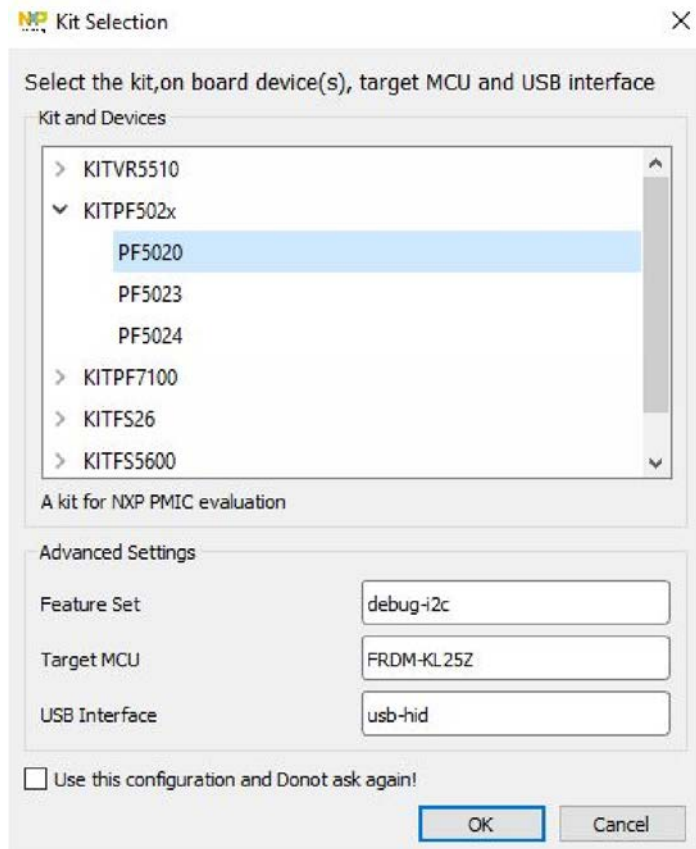

aaa-036556

5. The NXPGUI interface should open and load the main framework. Make sure to confirm if the GUI can identify the USB device properly. This is displayed by the active **Start** button on the top-left corner of the GUI.
 Note: The USB cable should be connected for the GUI to recognize and be able to connect to the device.
6. Click **Start** to enable the connection to the device. The device status can be read from the bottom-left corner of the GUI.



aaa-036557

7. Once the device is connected, the system is ready for Hardwire, TBB or OTP operation as desired.

7 Using the KITPF5020FRDMEVM evaluation board

This section summarizes the overall setup. Detailed description is provided in the following sections.

7.1 Operating in Hardwire mode

To operate the board with the default hardwire configuration, complete the following procedure:

1. Short J34 in position 2-3 and SW17 in position 1 (PWRON = high), or leave J34 open to let the MCU on the board control the pin.
2. Short J39 in position 2-3 (VDDOTP = V1P5D).
3. Short J40 in position 1-2 (TBBEN = Low).

In Hardwire mode, applying power to the board turns On the device by default. However, when the GUI is started, and the device is connected, the PMIC turn On/Off can be controlled via the PWRON control in the **IO PINS** tab of the main window.

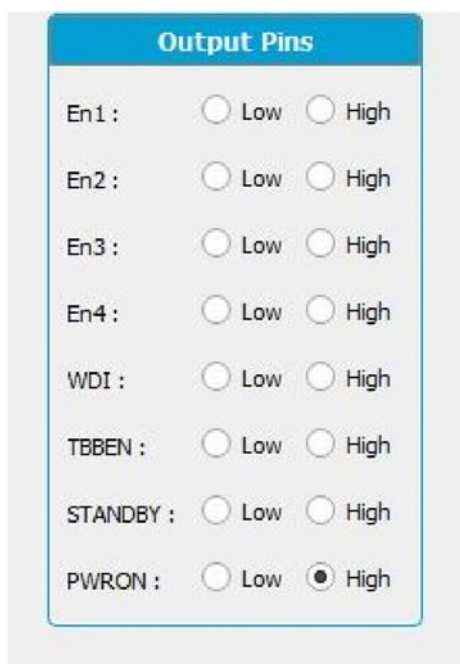

aaa-036559

7.2 Operating in TBB mode

To operate the device in TBB mode, a TBB script can be created using the OTP section of the NXPGUI (installed in the previous steps).

To generate a TBB script, complete the following procedure:

1. Select the configuration settings in the OTP tool as required.
2. Generate a TBB script using the Export section on the OTP tool (make sure to fill all required fields marked with a * next to them). Save the generated TBB file in a known location.

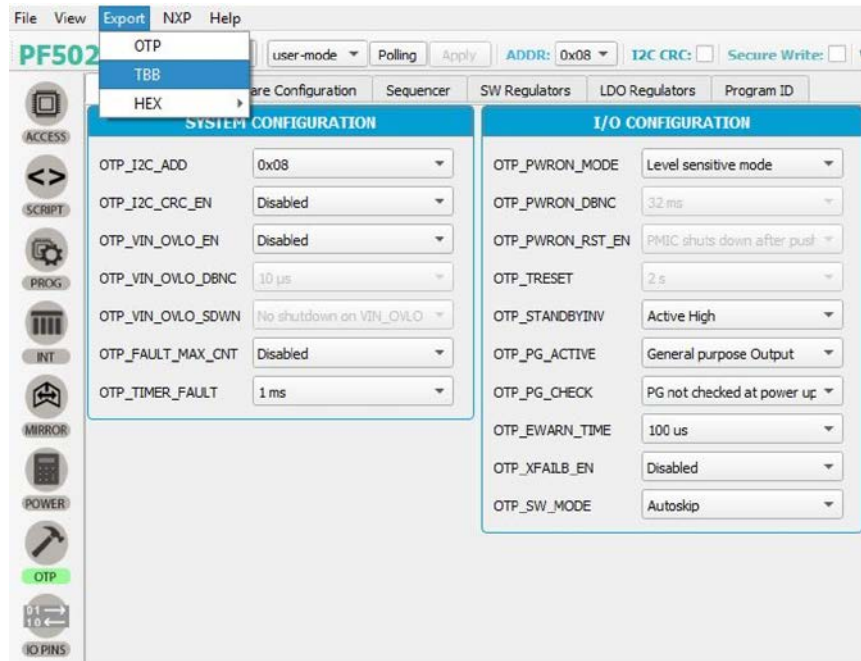

aaa-036560

To operate the board in TBB mode, complete the following procedure:

1. Set SW17 to position to 3 (PWRON to GND).
2. Short J40 in position 2-3 (TBB = V1P5D).
- Or
3. Use the NXPGUI to select the TBB mode, when the KL25Z interface board is connected to the EVB. Disconnect jumpers J40, J41 and J42 from the board as explained in [Section 4.2.2 "Jumper, switch, and shunt configuration"](#).

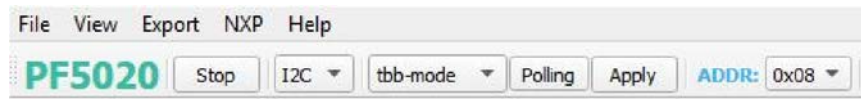

aaa-036561

4. In the Script section of the GUI, use the command window to load the TBB script created and click **Run** to start programming the PF5020.
5. After Script is done programming, the device is automatically enabled with the selected TBB configuration.

7.3 Programming/burning OTP in TBB mode

To program the OTP, the device must be operated in TBB mode. An OTP script can be created using the NXPGUI OTP section.

1. Start the NXPGUI from the installation folder or from the Start menu. Follow the steps in [Section 6 "Configuring the hardware for startup"](#) to start the GUI and connect to the board.

2. Generate the desired OTP configuration and the configuration using the file menu on the top left.
3. Select OTP from the **Export** tab in the menu and save the generated OTP file(.txt) in a known location with a desired filename.

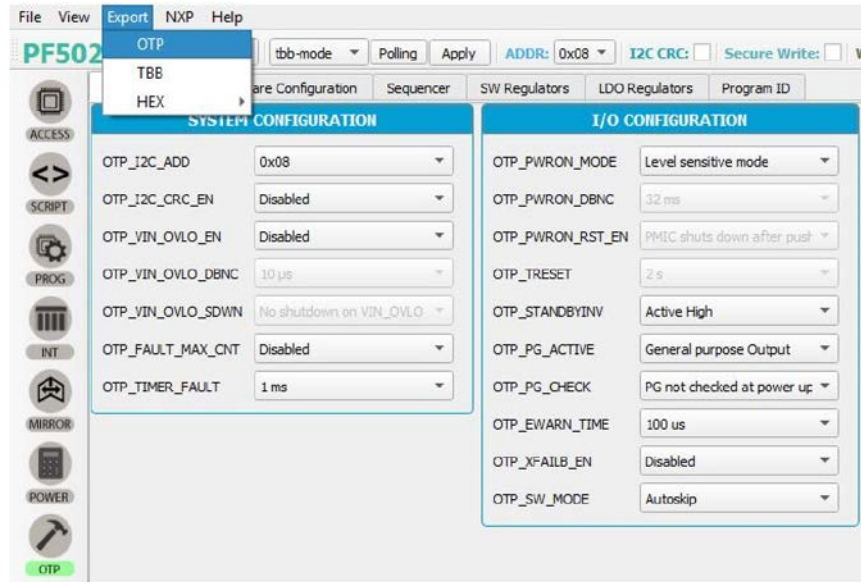

aaa-036563

4. To operate the board in TBB mode:
 - a. Follow step 3 in [Section 7.2 "Operating in TBB mode"](#).
 - b. Other jumpers must be in the configuration as explained in [Section 4.2.2 "Jumper, switch, and shunt configuration"](#).
5. Remove jumper on J39 and connect an external supply of 8.0 V on the VDDOTP pin at **J39, pin2 or TP103**.
6. In the PROG section, use the **Config Source** button to select "script", and then click the **Browse** button to load the config (*.cfg) file saved before. Click **Program** to start programming the PF5020 device.

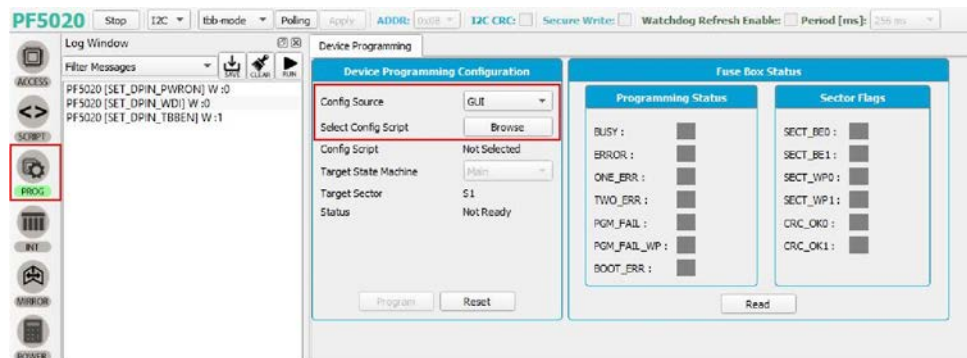

aaa-036564

7. After the script completes the programming, the device is automatically enabled with the selected OTP configuration. Remove the voltage on the VDDOTP pin (J39-2).

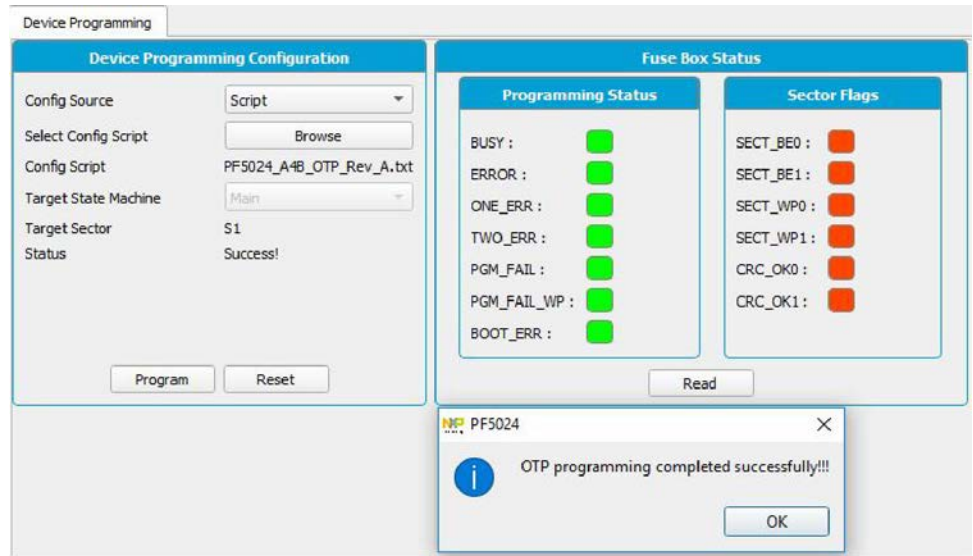

aaa-038473

8. Put the jumper on J39 (1-2). Select user-mode in the GUI and click **Apply** to turn On the board with new settings.
Or
9. Turn Off the power supply and turn back-on to reconnect the device.
10. Using the **IO Pins** tab in the main window of the GUI, set the PWRON pin high to enable the device with the programmed configuration. Ensure that the enable switches SW10, SW11, SW12, SW13 are set high for the regulators to turn On.

8 References

- [1] **KITPF5020FRDMEVM** — detailed information on this board, including documentation, downloads, and software and tools
<http://www.nxp.com/KITPF5020FRDMEVM>
- [2] **PF5020** — product information on PF5020, Power management integrated circuit (PMIC) for high performance applications
<http://www.nxp.com/PF5020>
- [3] **FRDM-KL25Z** — detailed information on this board, including documentation, downloads, and software and tools
<https://www.nxp.com/FRDM-KL25Z>

9 Revision history

Revision history

Rev	Date	Description
v.1	20200630	Initial version

10 Legal information

10.1 Definitions

Draft — The document is a draft version only. The content is still under internal review and subject to formal approval, which may result in modifications or additions. NXP Semiconductors does not give any representations or warranties as to the accuracy or completeness of information included herein and shall have no liability for the consequences of use of such information.

10.2 Disclaimers

Limited warranty and liability — Information in this document is believed to be accurate and reliable. However, NXP Semiconductors does not give any representations or warranties, expressed or implied, as to the accuracy or completeness of such information and shall have no liability for the consequences of use of such information. NXP Semiconductors takes no responsibility for the content in this document if provided by an information source outside of NXP Semiconductors. In no event shall NXP Semiconductors be liable for any indirect, incidental, punitive, special or consequential damages (including - without limitation - lost profits, lost savings, business interruption, costs related to the removal or replacement of any products or rework charges) whether or not such damages are based on tort (including negligence), warranty, breach of contract or any other legal theory. Notwithstanding any damages that customer might incur for any reason whatsoever, NXP Semiconductors' aggregate and cumulative liability towards customer for the products described herein shall be limited in accordance with the Terms and conditions of commercial sale of NXP Semiconductors.

Right to make changes — NXP Semiconductors reserves the right to make changes to information published in this document, including without limitation specifications and product descriptions, at any time and without notice. This document supersedes and replaces all information supplied prior to the publication hereof.

Applications — Applications that are described herein for any of these products are for illustrative purposes only. NXP Semiconductors makes no representation or warranty that such applications will be suitable for the specified use without further testing or modification. Customers are responsible for the design and operation of their applications and products using NXP Semiconductors products, and NXP Semiconductors accepts no liability for any assistance with applications or customer product design. It is customer's sole responsibility to determine whether the NXP Semiconductors product is suitable and fit for the customer's applications and products planned, as well as for the planned application and use of customer's third party customer(s). Customers should provide appropriate design and operating safeguards to minimize the risks associated with their applications and products. NXP Semiconductors does not accept any liability related to any default, damage, costs or problem which is based on any weakness or default in the customer's applications or products, or the application or use by customer's third party customer(s). Customer is responsible for doing all necessary testing for the customer's applications and products using NXP Semiconductors products in order to avoid a

default of the applications and the products or of the application or use by customer's third party customer(s). NXP does not accept any liability in this respect.

Suitability for use in automotive applications — This NXP Semiconductors product has been qualified for use in automotive applications. Unless otherwise agreed in writing, the product is not designed, authorized or warranted to be suitable for use in life support, life-critical or safety-critical systems or equipment, nor in applications where failure or malfunction of an NXP Semiconductors product can reasonably be expected to result in personal injury, death or severe property or environmental damage. NXP Semiconductors and its suppliers accept no liability for inclusion and/or use of NXP Semiconductors products in such equipment or applications and therefore such inclusion and/or use is at the customer's own risk.

Export control — This document as well as the item(s) described herein may be subject to export control regulations. Export might require a prior authorization from competent authorities.

Evaluation products — This product is provided on an "as is" and "with all faults" basis for evaluation purposes only. NXP Semiconductors, its affiliates and their suppliers expressly disclaim all warranties, whether express, implied or statutory, including but not limited to the implied warranties of non-infringement, merchantability and fitness for a particular purpose. The entire risk as to the quality, or arising out of the use or performance, of this product remains with customer. In no event shall NXP Semiconductors, its affiliates or their suppliers be liable to customer for any special, indirect, consequential, punitive or incidental damages (including without limitation damages for loss of business, business interruption, loss of use, loss of data or information, and the like) arising out of the use of or inability to use the product, whether or not based on tort (including negligence), strict liability, breach of contract, breach of warranty or any other theory, even if advised of the possibility of such damages. Notwithstanding any damages that customer might incur for any reason whatsoever (including without limitation, all damages referenced above and all direct or general damages), the entire liability of NXP Semiconductors, its affiliates and their suppliers and customer's exclusive remedy for all of the foregoing shall be limited to actual damages incurred by customer based on reasonable reliance up to the greater of the amount actually paid by customer for the product or five dollars (US\$5.00). The foregoing limitations, exclusions and disclaimers shall apply to the maximum extent permitted by applicable law, even if any remedy fails of its essential purpose.

Translations — A non-English (translated) version of a document is for reference only. The English version shall prevail in case of any discrepancy between the translated and English versions.

10.3 Trademarks

Notice: All referenced brands, product names, service names and trademarks are the property of their respective owners.

NXP — is a trademark of NXP B.V.

SMARTMOS — is a trademark of NXP B.V.

Tables

Tab. 1. Evaluation board jumper, switch, and shunt descriptions 6	Tab. 2. Bill of Materials 15
---	------------------------------------

Figures

Fig. 1. KITPF5020FRDMEVM 1	Fig. 8. FRDM-KL25Z interface 10
Fig. 2. Evaluation board featured component locations 5	Fig. 9. Top 11
Fig. 3. Primary PMIC reference 7	Fig. 10. Layer 2 12
Fig. 4. Power generation 8	Fig. 11. Layer 3 12
Fig. 5. Pull-ups, power goods, and status indicators 8	Fig. 12. Layer 4 13
Fig. 6. Load configurations 9	Fig. 13. Layer 5 14
Fig. 7. Signal and power measurement 10	Fig. 14. Bottom 14