

XE166 Family

Hardware Manual XE166 Low End Easy Kit Board V1.5

Hardware Manual

V1.5, 2011-03

Microcontrollers

Edition 2011-03

**Published by
Infineon Technologies AG
81726 Munich, Germany**

**© 2011 Infineon Technologies AG
All Rights Reserved.**

LEGAL DISCLAIMER

THE INFORMATION GIVEN IN THIS APPLICATION NOTE IS GIVEN AS A HINT FOR THE IMPLEMENTATION OF THE INFINEON TECHNOLOGIES COMPONENT ONLY AND SHALL NOT BE REGARDED AS ANY DESCRIPTION OR WARRANTY OF A CERTAIN FUNCTIONALITY, CONDITION OR QUALITY OF THE INFINEON TECHNOLOGIES COMPONENT. THE RECIPIENT OF THIS APPLICATION NOTE MUST VERIFY ANY FUNCTION DESCRIBED HEREIN IN THE REAL APPLICATION. INFINEON TECHNOLOGIES HEREBY DISCLAIMS ANY AND ALL WARRANTIES AND LIABILITIES OF ANY KIND (INCLUDING WITHOUT LIMITATION WARRANTIES OF NON-INFRINGEMENT OF INTELLECTUAL PROPERTY RIGHTS OF ANY THIRD PARTY) WITH RESPECT TO ANY AND ALL INFORMATION GIVEN IN THIS APPLICATION NOTE.

Information

For further information on technology, delivery terms and conditions and prices, please contact the nearest Infineon Technologies Office (www.infineon.com).

Warnings

Due to technical requirements, components may contain dangerous substances. For information on the types in question, please contact the nearest Infineon Technologies Office.

Infineon Technologies components may be used in life-support devices or systems only with the express written approval of Infineon Technologies, if a failure of such components can reasonably be expected to cause the failure of that life-support device or system or to affect the safety or effectiveness of that device or system. Life support devices or systems are intended to be implanted in the human body or to support and/or maintain and sustain and/or protect human life. If they fail, it is reasonable to assume that the health of the user or other persons may be endangered.

XE166

Revision History: V1.5 2011-03

Previous Version(s): 1.4

Trademarks

TriCore® is a trademark of Infineon Technologies AG.

We Listen to Your Comments

Is there any information in this document that you feel is wrong, unclear or missing? Your feedback will help us to continuously improve the quality of this document. Please send your proposal (including a reference to this document) to:

mcdocu.comments@infineon.com



Table of Contents

1	Introduction - XE166 family	5
2	General Information about XE166 Easy Kit Board	6
2.1	Summary of Features	6
2.2	Block Diagram	7
2.3	Board Overview	8
2.4	DIP Switch S101	9
2.4.1	Basic Startup Configuration for XE16x (L/ U -Series)	10
2.5	USB Drive installation	10
2.6	Easy Kit Power Supply concept	12
2.6.1	Power Supply via Power Plug	13
3	Information in Detail	14
3.1	Switch S101	14
3.1.1	DIP Switch Setting for XE16x (L/ U -Series)	14
3.2	Headers, Connectors and Components	15
3.2.1	USB Interface	15
3.2.2	CAN0 (X106)	15
3.2.3	LIN Interface (X105)	16
3.2.4	OCDS Interface	16
3.2.5	DAP Interface	16
3.2.6	ADC	17
3.2.7	LEDs	17
3.2.8	Serial EEPROM	17
3.3	Pin Definition and Location	18
3.3.1	64 - Pinout	18
3.3.2	48 - Pinout	20
3.3.3	38 - Pinout	22
3.4	Zero Ohm Resistors	23
4	Getting Started	24
4.1	Power Supply	24
4.2	BMI Programming	24
4.3	OCDS Debugging Interface	24
4.4	USB Interface for UART support	24
5	Schematic	25

1 Introduction - XE166 family

XE166 family - More performance, more Flash, better peripherals

With more than 15 successful years in the microcontroller market place, C166 has set the standard for 16-bit architectures with the highest aggregate volume share of all available 16-bit devices.

With its fast interrupt response and context switching, the C166 family is ideally suited for automotive, industrial, mass storage and wired as well as wireless communications applications.

Compared with the XC166, XE166 delivers more performance, more Flash memory, more RAM, strongly enhanced peripherals and a complete DSP library.

MCU and DSP in a core

Infineon Technologies' Real Time Signal Controller combines the traditional strengths of a Microcontroller Unit (MCU) to control peripherals with the computing power of Digital Signal Processors (DSP). All in one enhanced C166S V2 core. Together, the Microcontroller's real-time capability and ease of use and the DSP's mathematical performance and data throughput form a powerful single-chip solution ideal for many embedded applications.

For detailed technical information about the different derivatives please refer to the XE166 family web pages on the Infineon Internet.

<http://www.infineon.com/XE166>

This document covers all products of the XE162xL, XE161xL, XE161FU and XE160FU series.

2 General Information about XE166 Easy Kit Board

2.1 Summary of Features

- Infineon's XE166 Controller in LQFP-64, VQFN-48 and TSSOP-38 Package
- High Speed CAN Transceiver, LIN Transceiver, USB to UART/JTAG bridge
- 8 Low Power Status LEDs
- Easy access to all pins
- 4-DIP switches for configuration
- On board USB to JTAG/UART interface
- Powered via USB

Connectors

The XE166 Board offers a wide variety of connectors:

- USB connector for ASC/ JTAG/ SPD Interface
- 4-pin header for LIN Transceiver
- 16-pin header for JTAG interface (OCDS)
- 10-pin (2x5) header for CAN High Speed Transceiver (CAN0)
- 10-pin header for DAP/ SPD interface

Components

- Low-Drop Voltage Regulator TLE 4274
- Four status LED's for Power/RESET/JTAG
- CAN-Transceiver TLE 6251DS
- LIN Transceiver TLE 7259
- FT2232HL Dual USB to UART/JTAG interface
- SPI EEPROM 128 Kbit AT25128N¹⁾
- 8 general purpose LEDs
- Potentiometer for ADC
- Reset switch

Zero Ohm Bridges

- Zero Ohm resistors give the flexibility to configure the systems functionality

1) The soldered part may differ from the schematic, for example Atmel 25040AN.

2.2 Block Diagram

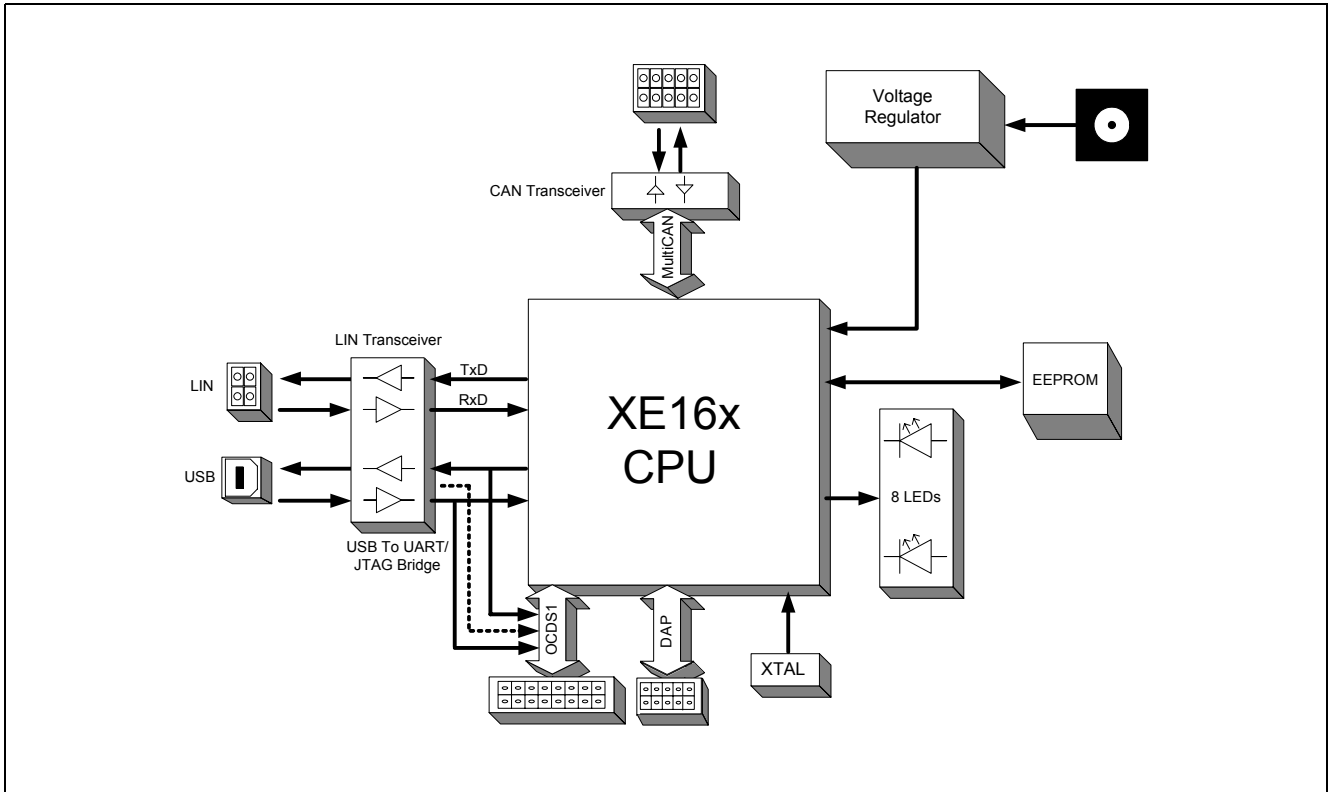

Figure 1 Block diagram of XE166 Easy Kit layout overview

2.3 Board Overview

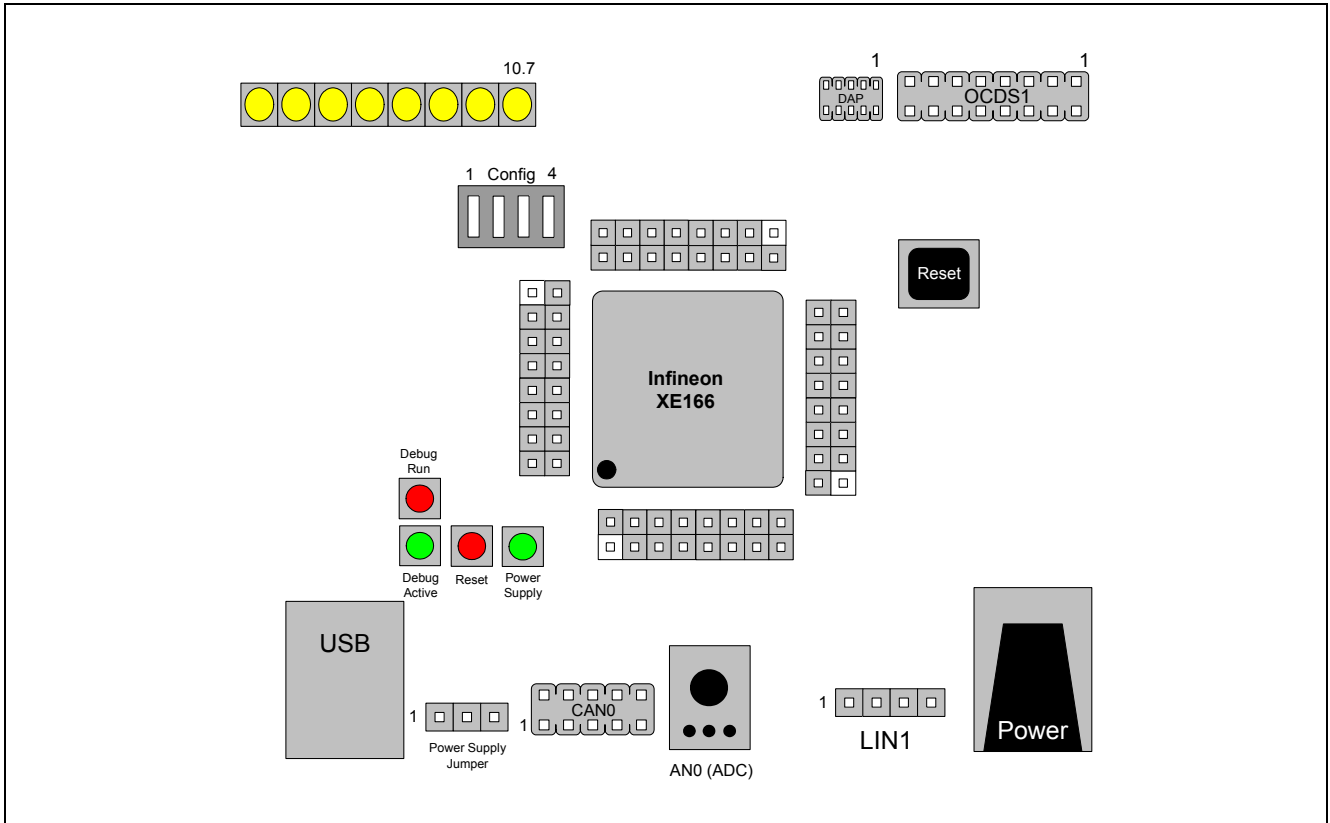

Figure 2 Top View (basic components)

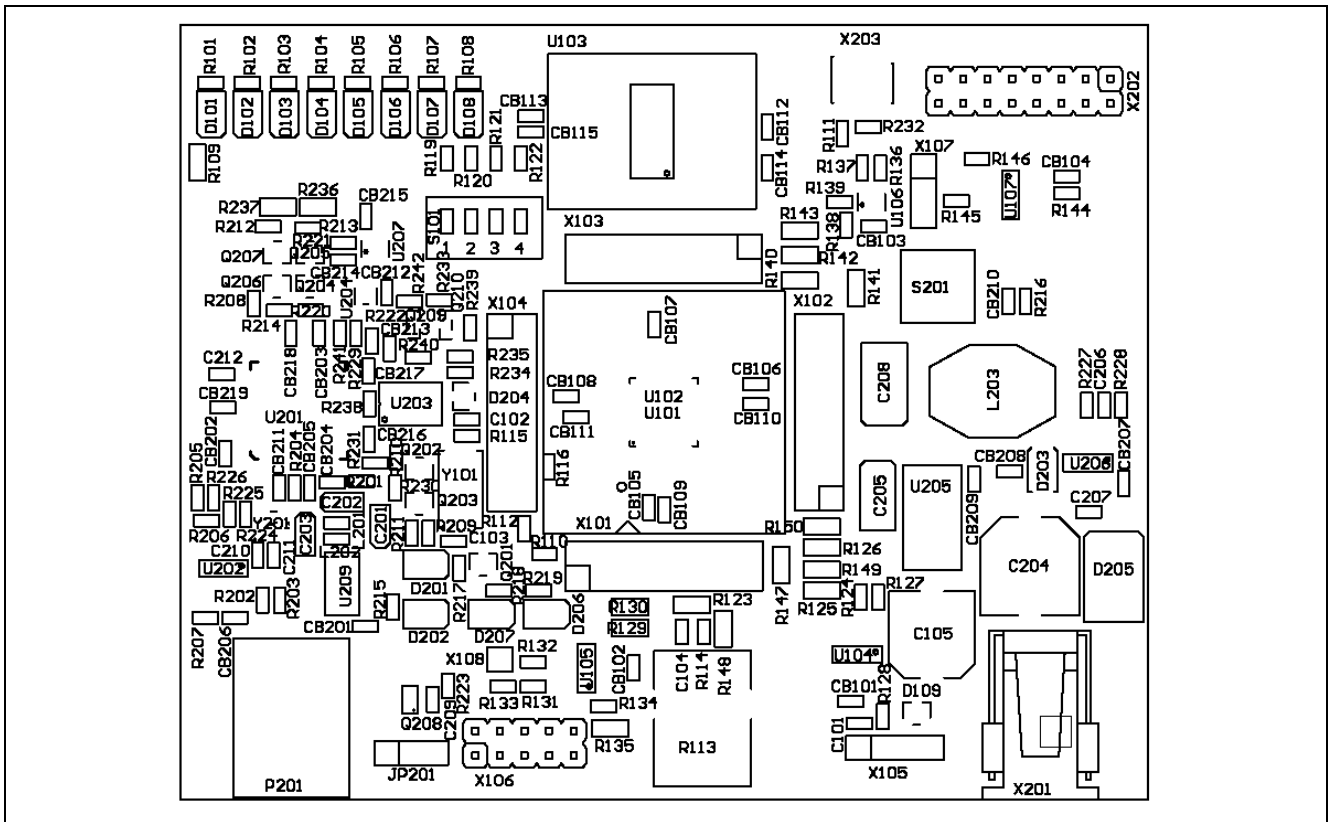

Figure 3 Top view in detail

2.4 DIP Switch S101

Although most of the programmable features of the XE166 are selected by software either during the initialization phase or repeatedly during program execution, some features must be selected earlier because they are used for the first access of the program execution.

These configurations are accomplished by latching the logic levels at a number of pins at the end of the internal reset sequence.

DIP switch S101 allows to configure the startup setting of the XE166 during RESET. The default System Startup Configuration is shown in [Table 1](#). By default all DIP Switches are OFF. The XE166 executes a standard start from internal Flash.

Note: The Kit is programmed with BMI for DAP. To connect a JTAG debugger box from a Tool vendor (KEIL, PLS), the BMI need to be reprogrammed to JTAG using a flash programming software (e.g. Memtool).

Table 1 Default Configuration

Name in schematic	Default configuration	Description
S101		Startup configuration: Standard start from internal Flash (Default)

2.4.1 Basic Startup Configuration for XE16x (L/ U -Series)

Table 2 Basic Startup Configuration via External Circuitry

Startup Mode	TRST	BMI value ¹⁾		CFG-pins	
				P2.9	P10.12
Internal Start from Flash, no debug	0	not checked		x	x
Start-up and debug mode from BMI	1	BMI valid	BMI.BLS=disable	x	x
Start-up and debug mode from BMI			BMI.BLS=enable	x	0
ASC Bootloader				x	1
ASC Bootloader		BMI invalid/ unconfigured		x	1
CAN Bootloader ²⁾				0	0
Internal start from Flash,JTAG debug pos.A				1	0

- 1) BMI0[15:12] = 0101_B means BMI.BLS=enable.
 BMI0[15:12] = 1010_B means BMI.BLS=disable.
 BMI0[15:12] = else means BMI is invalid.

- 2) CAN Bootloader is not available to XE16xU series.

Configuration pins are treated by firmware differently depending on additional conditions:

- If TRST=0 - it is purely hardware controlled (so-called "Zero-pin") configuration - device start from Internal Flash without debug support is executed
- If TRST=1 - the Boot Mode Index (BMI) is evaluated by firmware first and depending on the result - start-up mode and debug

For more detailed information about the DIP switch setting, please refer to [Chapter 3.1.1, Table 4](#).

2.5 USB Drive installation

All USB-Transaction are realized by the USB-Software running on a Host-Computer. The USB-Device driver is communicating with the Equipment connected to the Computer.

The driver for Easy Kit USB interface will be delivered with a Software called DAS (Device Access Server). The goal of the DAS architecture is to provide one single interface for all types of tools, which fulfills all performance and reliability needs. Additionally a driver for a virtual COM port will be installed.

Find out more about DAS on the Infineon Web page:

<http://www.infineon.com/DAS>

This DAS Software can be found in the Easy Kit CD under the Tools section. DAS Software Version 3.0.0 or higher is required to be used with the Easy Kit.

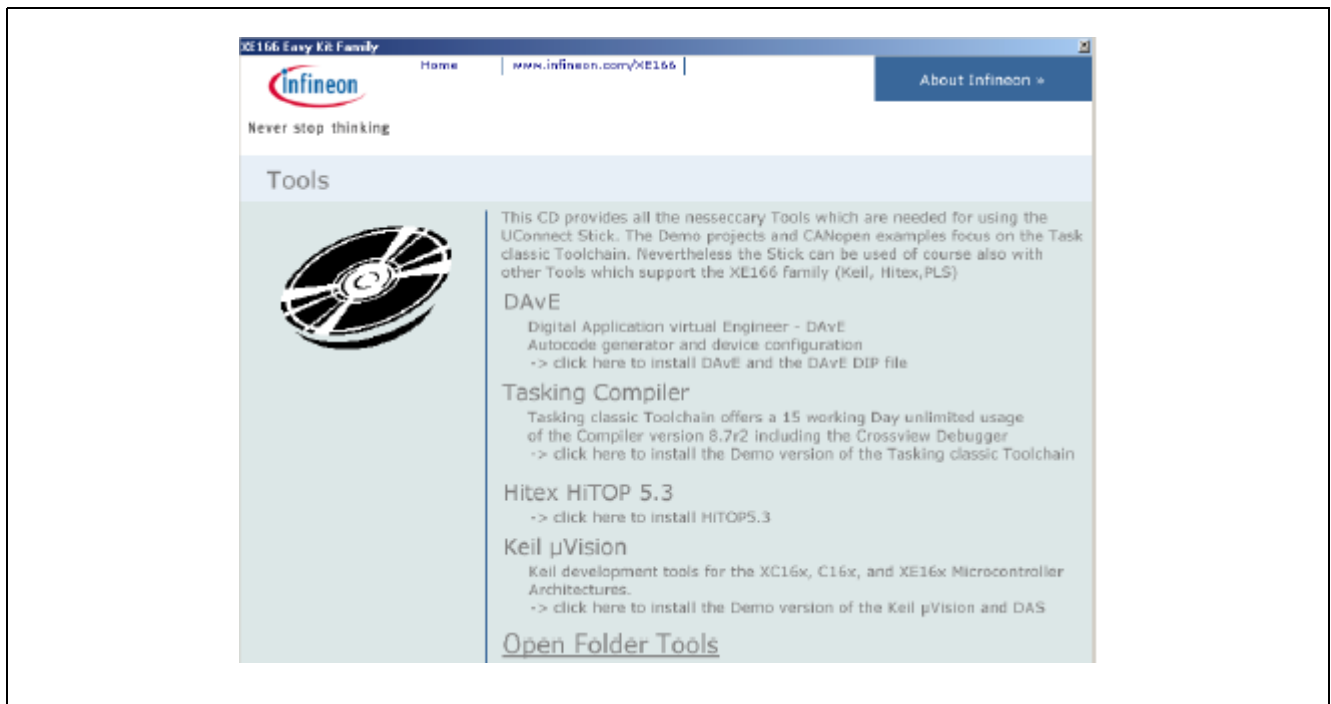

Figure 4 Tools install

2.6 Easy Kit Power Supply concept

The Easy Kit USB Power Supply concept allows the user to work with the Kit without an external Power Supply. If the USB power supply is not sufficient, an additional regulated DC power supply can be used.

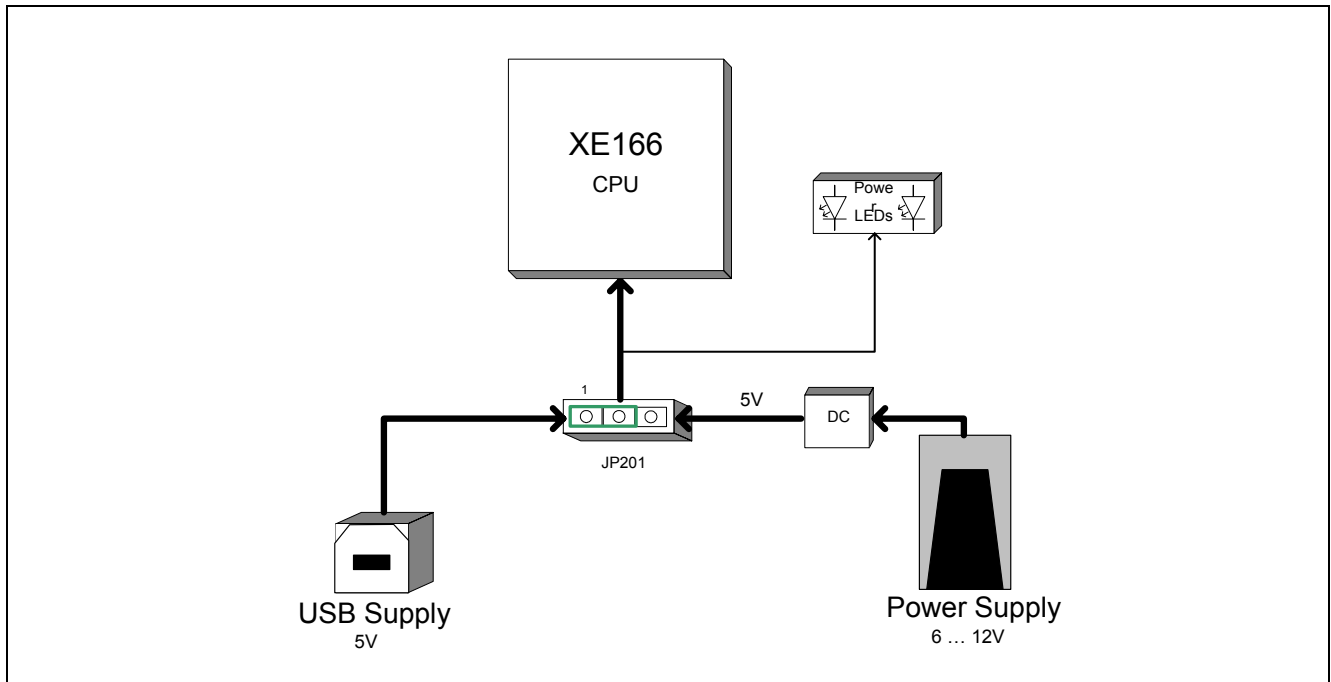
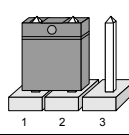
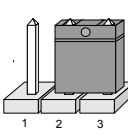

Figure 5 Easy Kit Power Supply concept

By means of the Power Supply Jumper JP201, USB, or the external power Supply can be selected to run the Easy Kit. The Setup for the Jumper JP201 is shown in [Table 3](#) below.

Table 3 Power Supply Jumper configuration

Name in schematic	Configuration	Description
JP201		Power Supply via USB Interface (Default)
JP201		Power Supply via Power Plug

The USB specification provides a 5 V supply on a single wire from which connected USB devices may draw power. The specification provides for no more than 5.25 V and no less than 4.35 V between the +ve and -ve bus power lines.

Initially, a device is only allowed to draw 100 mA. It may request more current from the upstream device in units of 100 mA up to a maximum of 500 mA. In practice, most ports will deliver the full 500 mA or more before shutting down power, even if the device hasn't requested it or even identified itself. If a (compliant) device requires more power than is available, then it cannot operate until the user changes the network (either by rearranging USB connections or by adding external power) to supply the required power.

Note: If the USB power supply is not sufficient, an external power supply is needed and the Jumper JP201 setting need to be changed.

Note: In case the USB Host PC goes into Suspend Mode, an external Power Supply should be used.

2.6.1 Power Supply via Power Plug

The XE166 Board can be supplied either with USB cable or with an external power supply. For external power supply, a regulated DC power supply with **max. 12Volt/ 400mA** can be connected to the power connector. The maximum power dissipation of the used voltage regulator has to be taken into account.

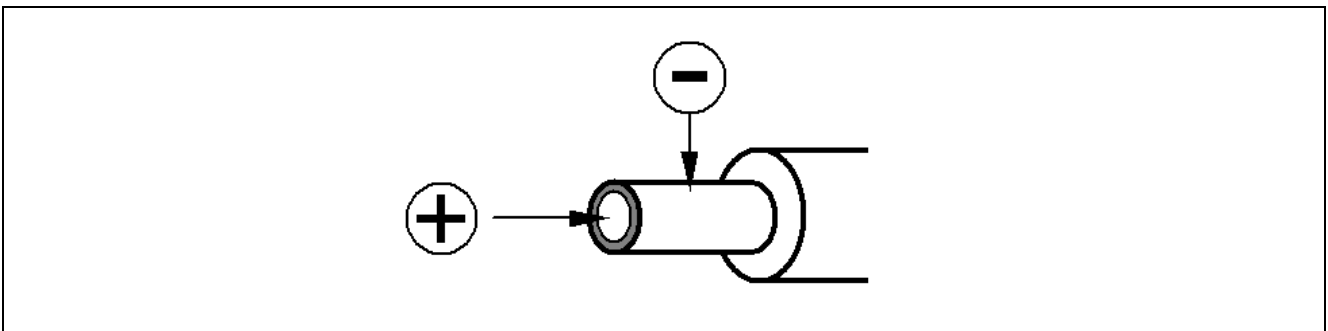

Figure 6 Power Supply

3 Information in Detail

The XE166 family supports variety of start-up modes, allowing the user to make selections in three aspects:

- Main functionality - where from the user code will be started (on-chip Flash, PSRAM, external memory);
- Optionally - a way for initial code-downloading into PSRAM before to start it:
 - From an external host via a communication interface - UART, CAN.
- Debug-related - either debugging will be possible, and if Yes - which debug-interface to use (SPD, JTAG, and DAP selectable pin-assignments via BMI).

The Easy Kit Board Manual covers only a limited number of start-up modes. For all possible start-up modes please refer to the corresponding User's Manual.

3.1 Switch S101

3.1.1 DIP Switch Setting for XE16x (L/ U -Series)

Table 4 DIP Switch Settings for S101

Name in schematic	Default configuration	Description
S101		Startup configuration: Standard start from internal Flash xx-xx-OFF-xx
S101		Startup configuration: BMI valid. BLS disable, Start-up and debug mode from BMI xx-xx-ON-xx
S101		Startup configuration: BMI valid. BLS enable, Start-up and debug mode from BMI xx-ON-ON-xx
S101		Startup configuration: BMI valid. BLS enable, Bootstrap loader ASC xx-OFF-ON-xx
S101		Startup configuration: BMI invalid. Bootstrap loader ASC xx-OFF-ON-xx
S101		Startup configuration: BMI invalid. Bootstrap loader CAN ON-ON-ON-xx

Table 4 DIP Switch Settings for S101

Name in schematic	Default configuration	Description
S101		Startup configuration: BMI invalid. JTAG Debug Mode A OFF-ON-ON-xx
S101		Startup configuration: All other positions are reserved

Note: Other than hardware configuration, the BMI value has to be configured in order for the device to run in the correct mode. For more information, refer to [Table 2](#).

3.2 Headers, Connectors and Components

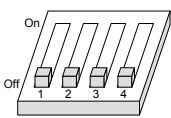
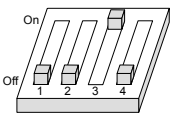
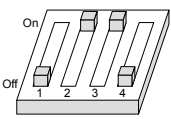
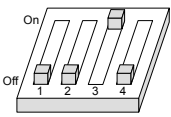
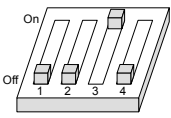
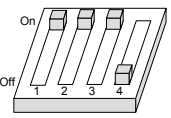
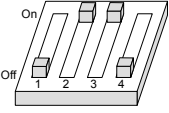
3.2.1 USB Interface

The USB connector is used for connection to a PC. Via the USB it is possible to power the board, using the USIC0 Channel 0 as serial connection via USB and Debugging via DAS. For the pinout of USB socket see [Figure 7](#).

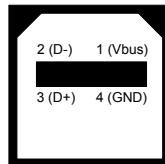

Figure 7 On-board header (P201)

3.2.2 CAN0 (X106)

One CAN transceiver is connected to the MultiCAN on XE166 node 0. The transceiver is connected to the IDC10 plug. For the pinout of IDC10 plug see [Figure 8](#). You can use a IDC female connector with crimp connector, flat cable and SUB-D 9 plug with crimp connector to have a 1:1 adapter to SUB-D 9.

CAN module is not available to XE16xU series.

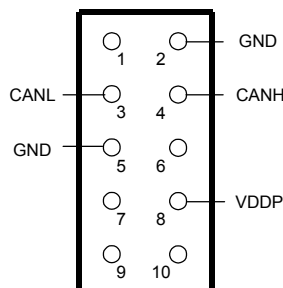

Figure 8 On-board header (X106)

3.2.3 LIN Interface (X105)

The board has a connector with 4 pins for LIN. For the pinout of the connector see [Figure 9](#). The LIN transceiver is connected to USIC1 Channel 0 for XE16xL module, and USIC0 Channel 0 for XE16xU module of the CPU.

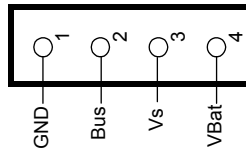

Figure 9 On-board header (X105)

3.2.4 OCDS Interface

The OCDS1 signals are connected to the IDC16 plug (X202). For pinout of the connector see [Figure 10](#). You can connect any debugger to this connector.

The signals /BRKIN and /BRKOUT are not connected by default.

If you connect a debug hardware, ensure that the MiniWiggler circuit is not active (ACTIV LED is off), and on the DAP connector (X203), no hardware is connected or the hardware is tristate.

If the ACTIV LED is on, then stop the active DAS Server JTAG over USB Chip and/or remove the USB connection to the PC.

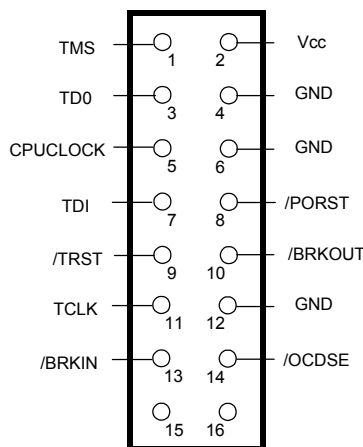

Figure 10 On-board header X202

3.2.5 DAP Interface

The board comes with a DAP connector (X203). For pinout of this connector see [Figure 11](#). You can connect a DAP/ SPD hardware here. If you use this connector make sure that the MiniWiggler is not active (ACTIV LED is off) and a connected OCDS1 hardware is disconnected or tristate.

For single pin DAP (SPD) interface, DAP1 is used.

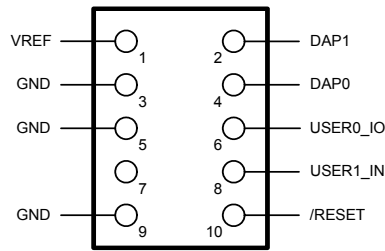

Figure 11 On-board header X203

3.2.6 ADC

On AN0 (ADC0) is a 10K potentiometer (R113) connected. You can apply a voltage between VAGND0 and VAREF0 to the AN0 channel via this potentiometer.

3.2.7 LEDs

Port 10 pin 0 up to pin 7 are connected to single LED's (D101... D108) and can be controlled by Software. These status LEDs are low active.

Table 5 LEDs description

LED number	Description
D201 (red)	Debug Run Mode (switched by DAS Server)
D202 (green)	Debug Active (Mini Wiggler circuit active)
D207 (red)	Power On Reset Active
D208 (green)	Board Voltage 5 Volts
D101 - D108 (yellow)	Status of P10L

3.2.8 Serial EEPROM

By default the USIC0 Channel 1 of the XE166 is connected to a serial EEPROM with a size of 512K (64 x 8). The default setting for the SSC is described in [Table 6](#).

Table 6 Serial EEPROM interface

Default Setting: SSC (USIC0 Channel 1)
P2.8 (SCK) with R140
P2.4 (SI) with R141
P2.10 (SO) with R142
P2.7 (CS) with R143

3.3 Pin Definition and Location

3.3.1 64 - Pinout

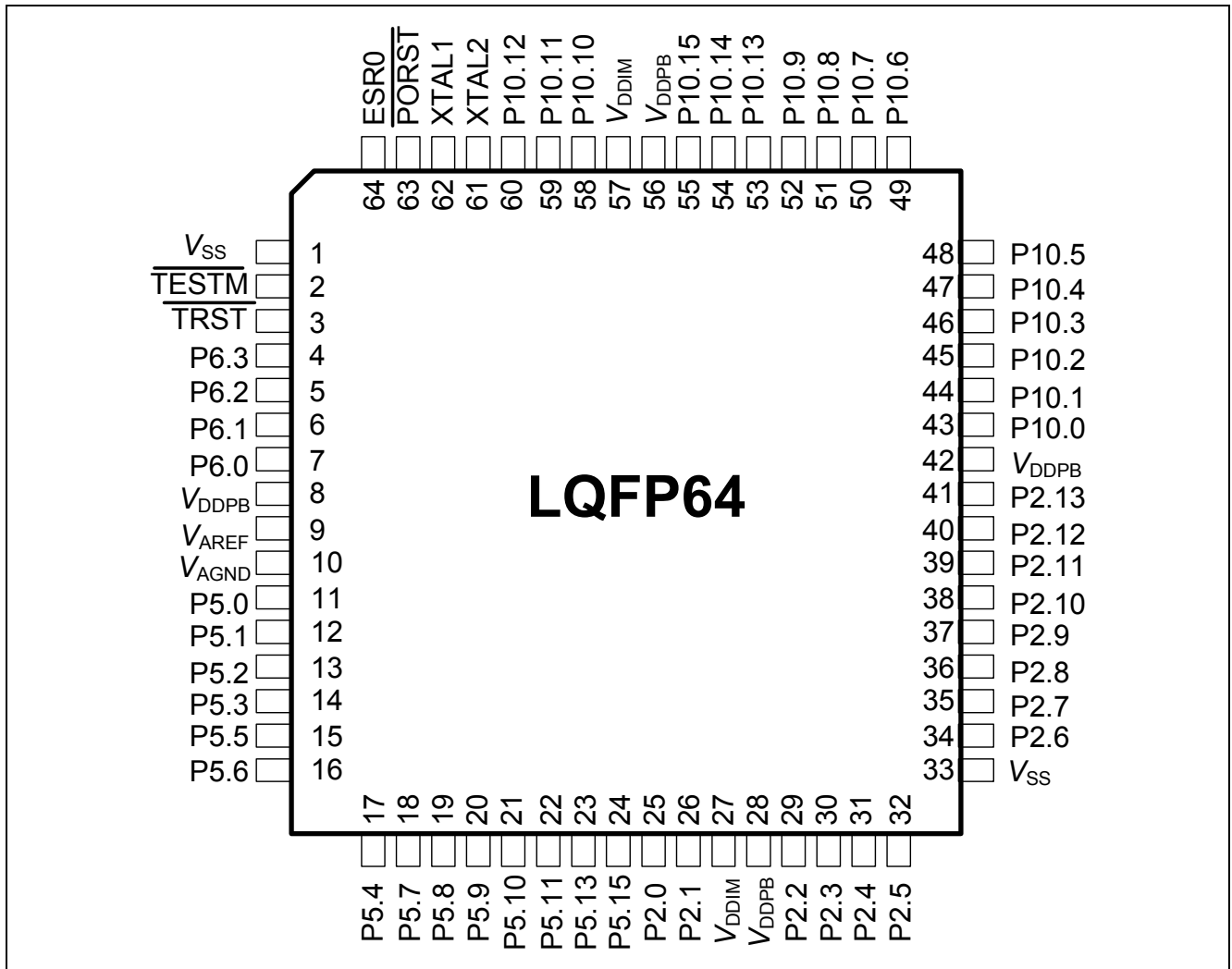

Figure 12 Pinout of the 64 pin device

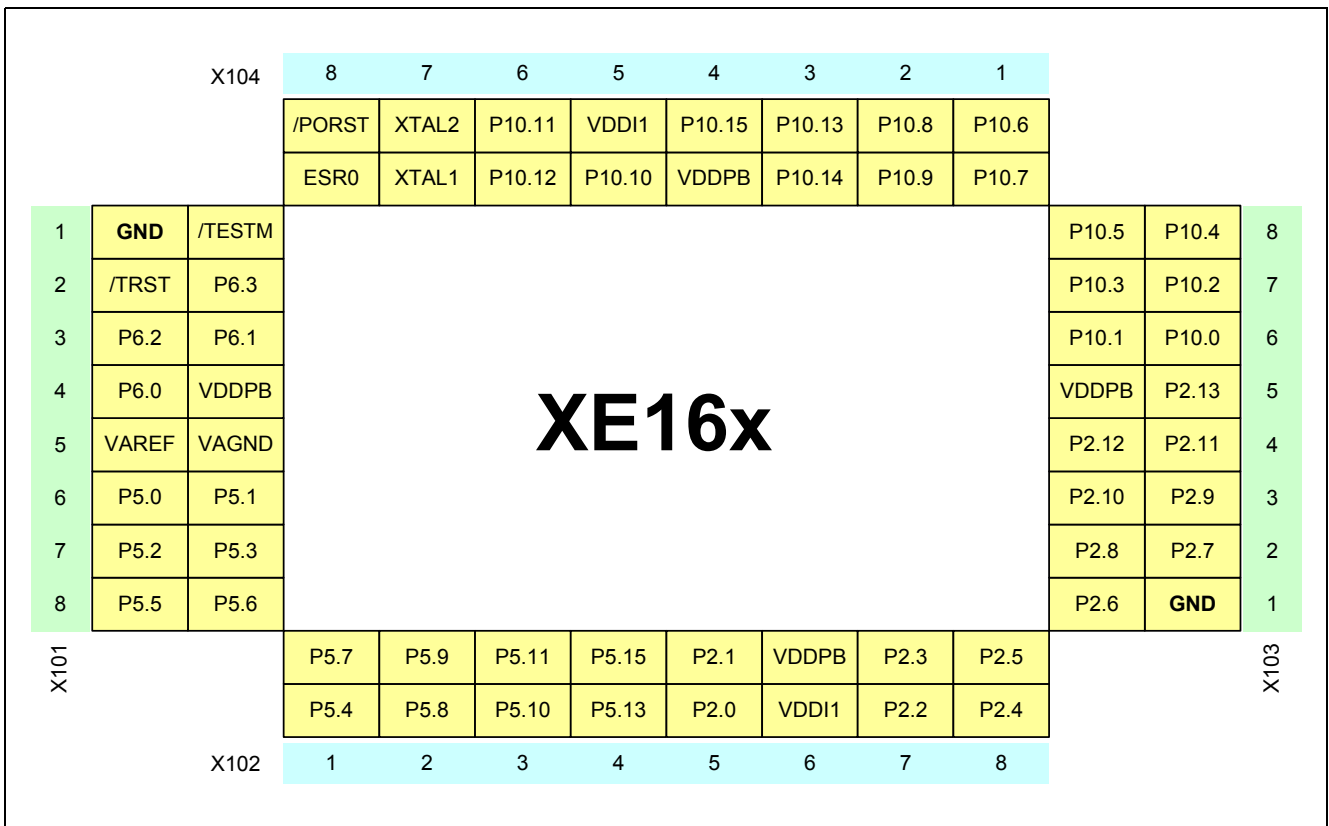

Figure 13 Pin connector of the 64 pin device

3.3.2 48 - Pinout

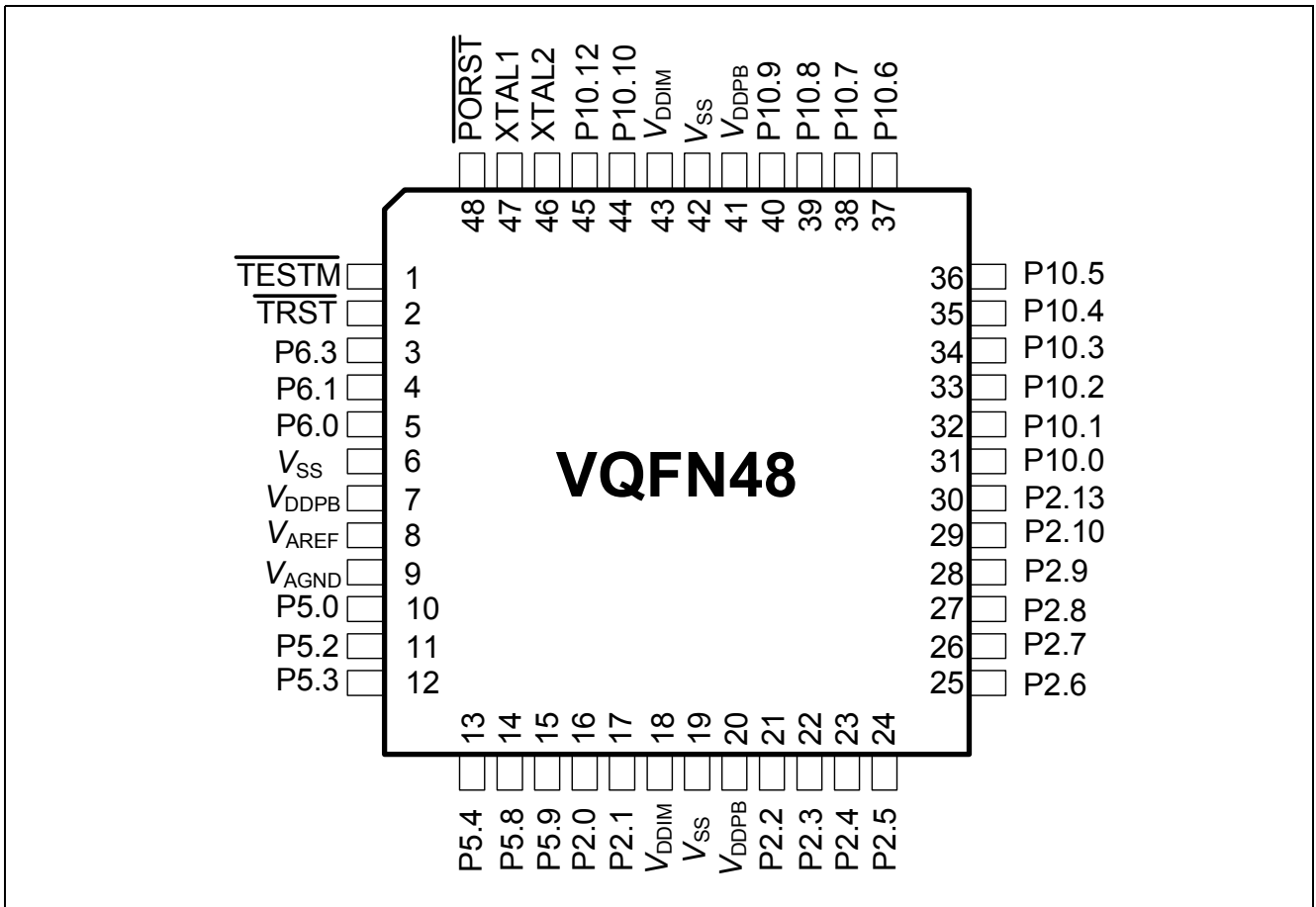

Figure 14 Pinout of the 48 pin device

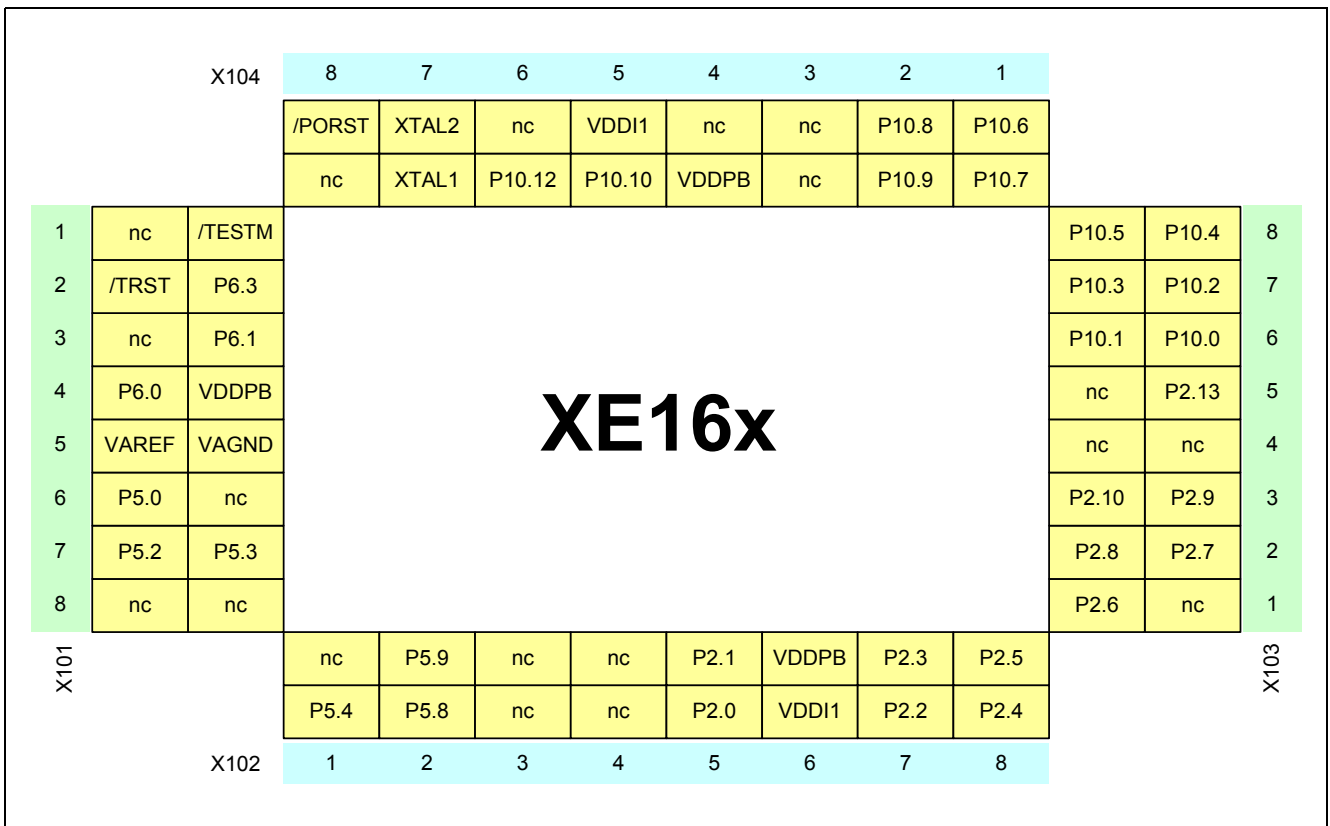

Figure 15 Pin connector of the 48 pin device

3.3.3 38 - Pinout

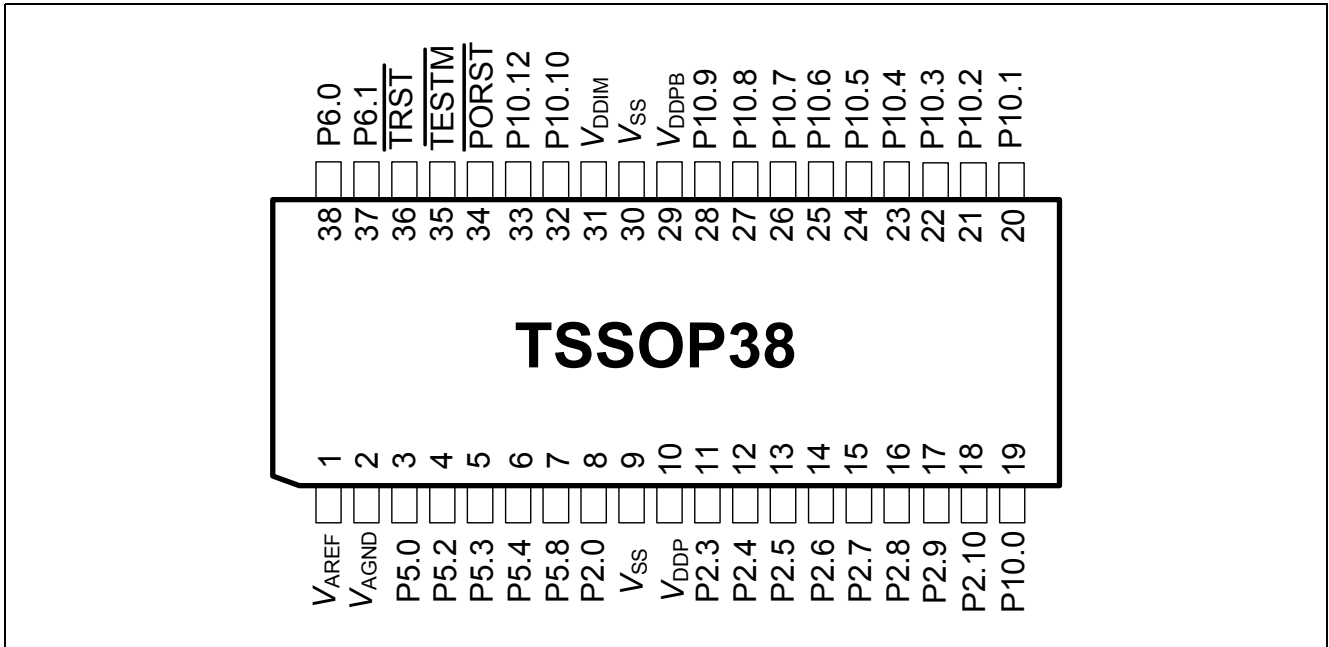

Figure 16 Pinout of the 38 pin device

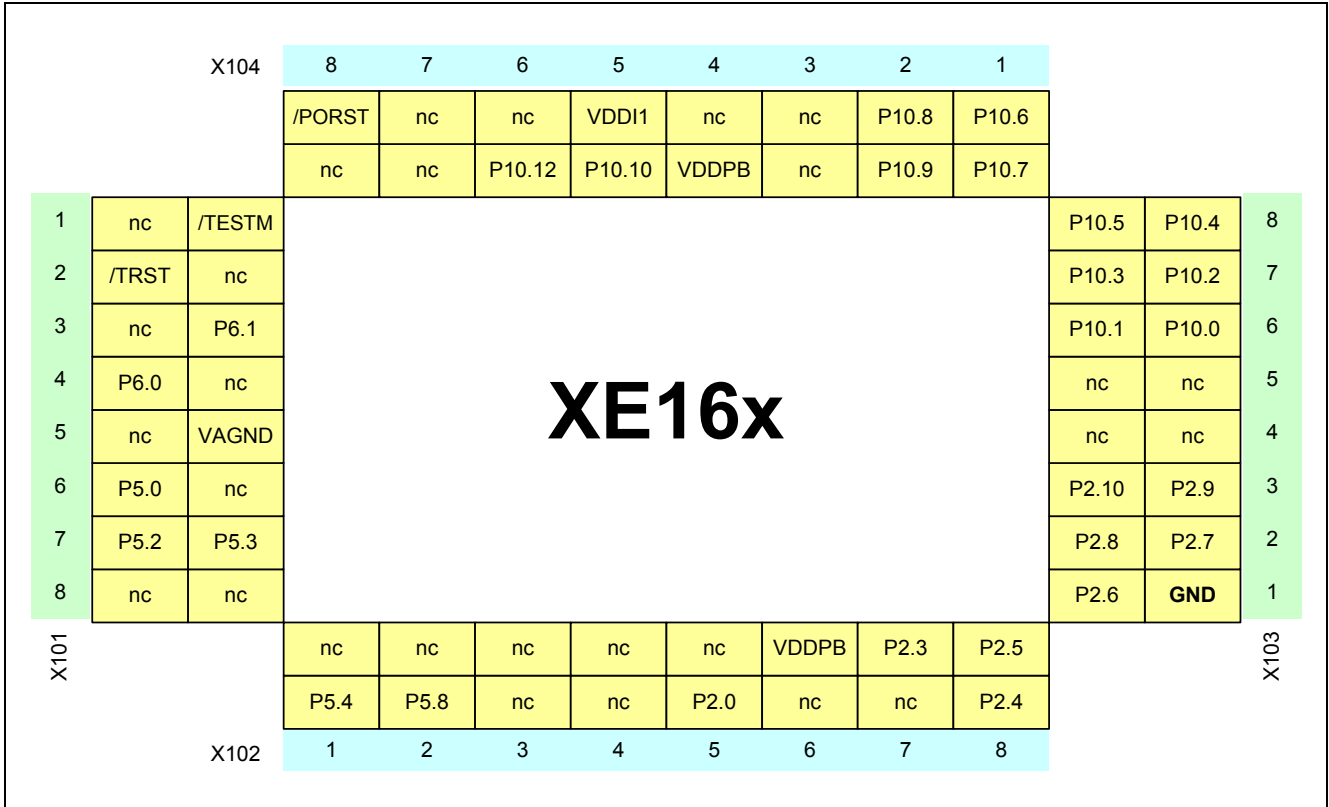

Figure 17 Pin connector of the 38 pin device

3.4 Zero Ohm Resistors

For configuration purposes several zero ohm resistors have been implemented. The functionality of these resistors are shown in the table below.

Table 7 Zero Ohm Resistors

Component	Name in schematic	Description
TLE7259 (LIN Transceiver Board)	R124	enable / disable
For XE16xL series	R125 / R126	connect / disconnect
For XE16xU series	R149 / R150	connect / disconnect
TLE6251DS (CAN Transceiver) ¹⁾	R129 / R130 R131 R135 R133 / 134	connect / disconnect (CAN0) enable / disable (CAN0) supply Bus voltage internal / external (CAN0) connect Bus / disconnect Bus (CAN0)
Microcontroller XE16x Analog reference	R148 R213	change of analog reference source
Voltage supply	R147	change of voltage supply
AT25128N ²⁾ (Serial EEPROM)	R140 / R141 R142 / R143	connect to USIC0 Channel 1 connect to USIC0 Channel 1
Status LED's Oscillator circuit	R109 R115 / R116	connect / disconnect LED's to 5 V oscillator gain
FT2232HL		
JTAG-Option:	R233, R238	open
DAP-Option:	R233, R238	assembled with 0R
ASC Bootloader: 64 Pin / 48 Pin/ 38 Pin	R236-R237	assembled with 0R
Other	R236-R237	open
U203:	R210	For internal use only
EEPROM 93LC46B:	R207	If ORG functionality is needed

1) CAN transceiver is not available to XE16xU series.

2) The soldered part may differ from the schematic, for example Atmel 25040AN.

4 Getting Started

4.1 Power Supply

If more current is needed, a regulated DC power supply with max. 12 Volts should be connected to the power connector. The maximum power dissipation of the used voltage regulator has to be taken into account. By default one green LED should be active. It indicates that the embedded voltage regulator supply the microcontroller.

Note: Power supply is not part of the delivery.

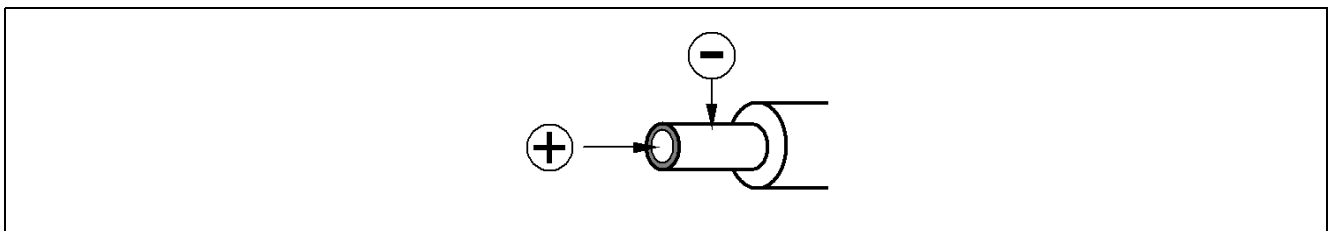

Figure 18 Power Supply Connector

4.2 BMI Programming

The XE166 Easy Kit supports Boot Mode Index (BMI) programming. This provides flexibility for the users to configure the device start-up mode. BMI value can be configured via software or tool.

For details on how to program the BMI value, please refer to the User's Manual.

4.3 OCDS Debugging Interface

The XE166 Easy Kit offers access to device via four interfaces (UART, JTAG, DAP, SPD), through a USB connection. With the FTDI chip, an on board USB JTAG wiggler has been implemented. Further, the USB interface allows to emulate a USB to UART bridge.

A simple 16-pin JTAG/ DAP/ SPD header can be used to connect a debugger from one of Infineon's tool suppliers. Both systems include an On-Chip Debug Support (OCDS) system, which provides convenient debugging, controlled directly by an external device via debug interface pins.

4.4 USB Interface for UART support

The USB connector is used for connection to a PC. Via the USB it is possible to power the board, using the ASC as serial connection via USB and Debugging via DAS. For the pinout of USB socket see [Figure 7](#).

Note: Before connecting the board to the PC, make sure that the actual DAS software is installed on the PC. For actual DAS software please contact your local FAE.

The latest version of the software can also be found on the DAS website:

www.infineon.com/DAS

5 Schematic

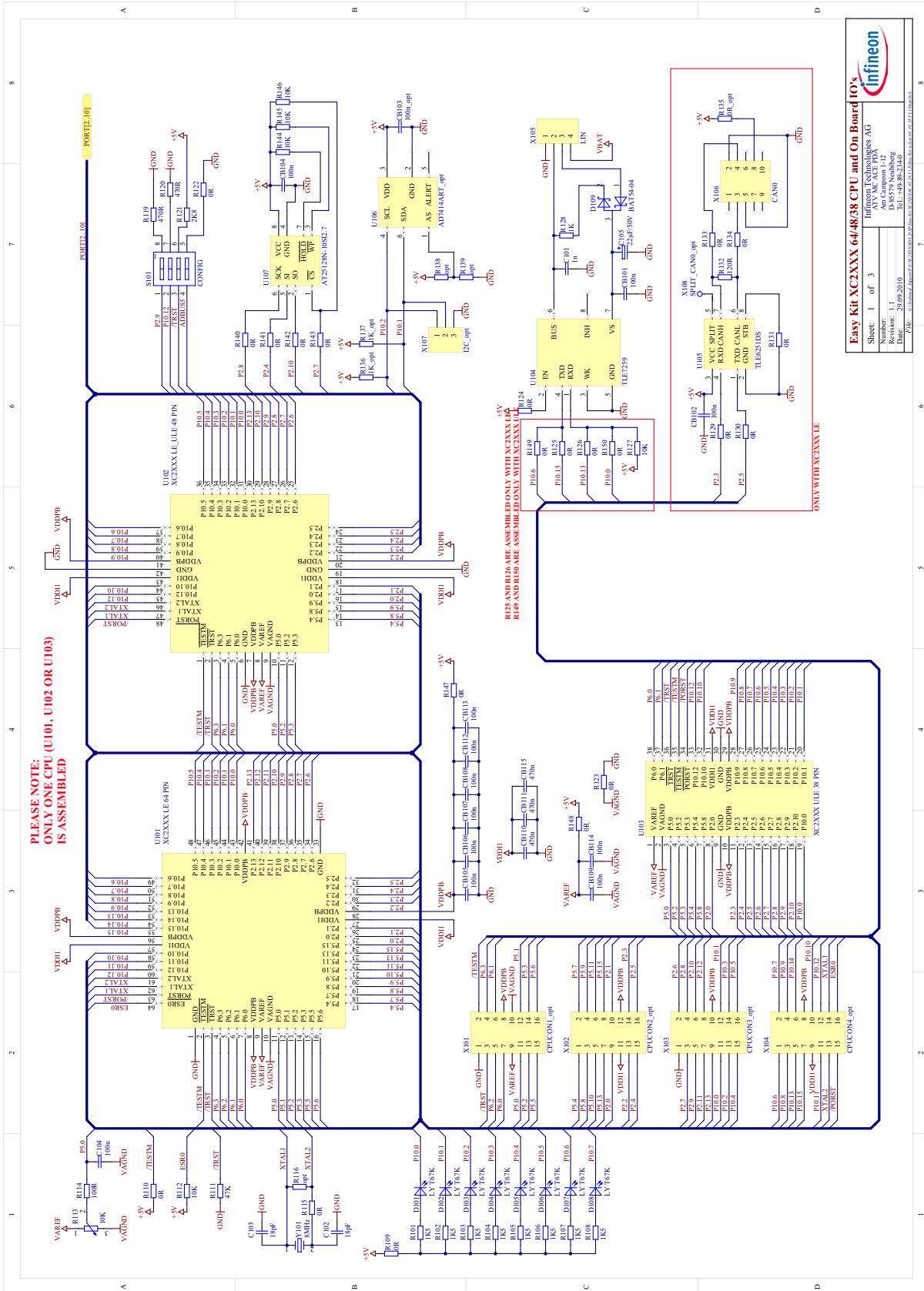

Easy Kit XC2XXX 64/48/38 CPU and On Board I/O's

Sheet: 1 of 3
 Number: 1.1
 Date: 29.09.2010
 Tel.: +49 89 2342 4000

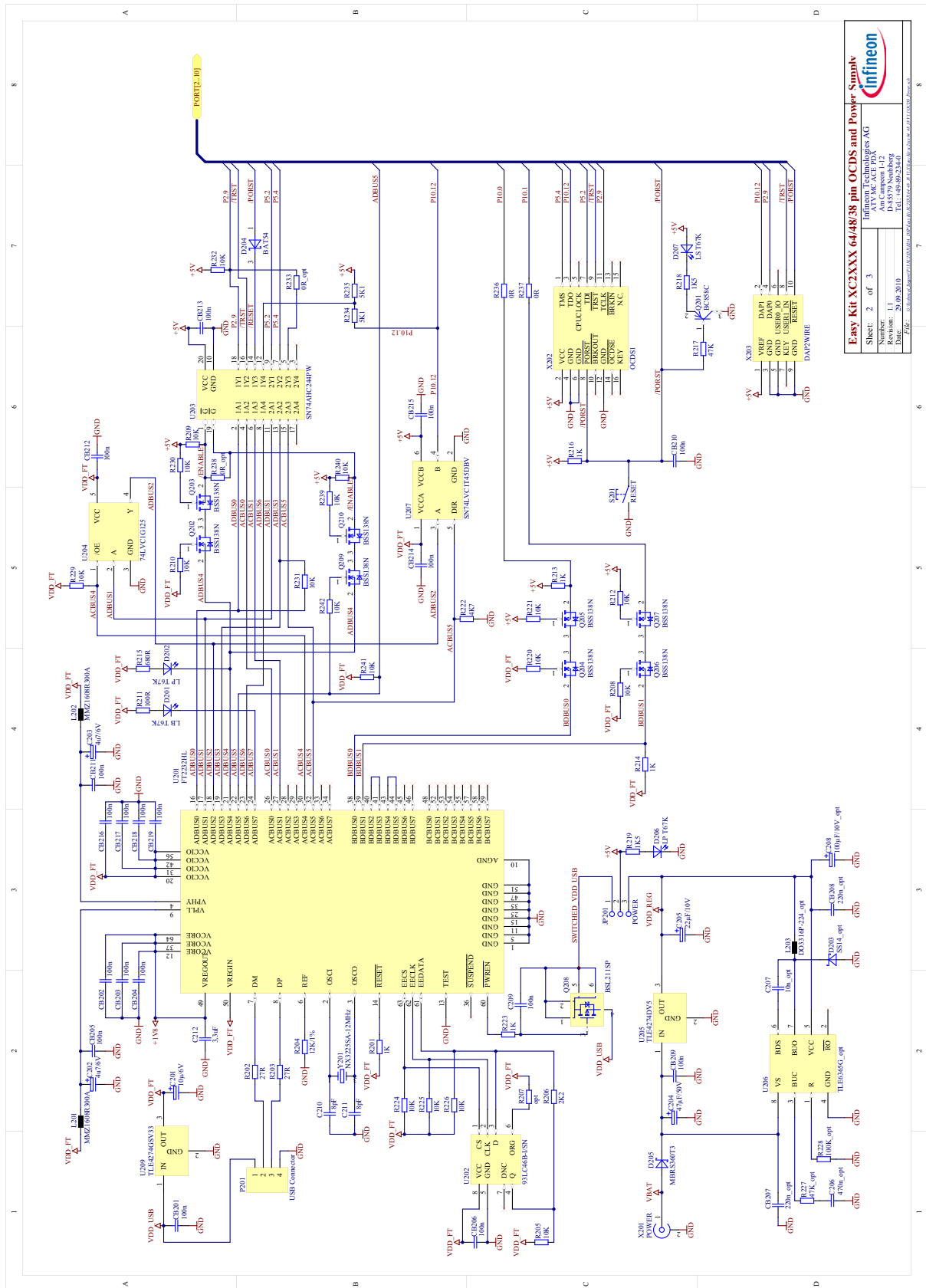

Easy Kit XC2XXX 64/48/38 pin OCS and Power Supply

Sheet: 2 of 3
 Title: XC2XXX Easy Kit
 Number: 11
 Date: 29.09.2010
 File: ...

Infineon Technologies AG
 ATU, AC, ACE, PD, PDS, AG
 Am Compton 112
 81739 Munich, Germany
 Tel.: +49 89 2344-0