

Evaluation Board for XMC4000 Family

XMC4700/XMC4800 Relax Kit Series-V1

Table of contents
Table of contents

	Table of contents	2
1	Introduction	3
1.1	Key Features	4
1.2	Block Diagram	5
2	Hardware Description	6
2.1	Power Supply	9
2.2	Pin Header X1 and X2	10
2.3	Arduino Compatible Connector	10
2.4	User Push Buttons and User LEDs	11
2.5	Debugging and UART-to-USB Communication	12
2.5.1	On-board Debug Probe	12
2.5.2	Cortex™ Debug Connector (10-pin)	12
2.6	Reset	13
2.7	CAN Transceiver	13
2.8	Serial Flash Memory	13
2.9	microSD Card	14
2.10	Ethernet	14
2.11	Boot Option	15
3	Production Data	15
3.1	Schematics	15
3.2	Components Placement and Geometry	24
3.3	List of Material	24
	Revision history	27
	Disclaimer	28

1 Introduction

1 Introduction

This document describes the features and hardware details of the XMC4700/XMC4800 Relax Kit Series-V1 equipped with an ARM® Cortex® -M4 based XMC™ microcontroller from Infineon Technologies AG.

It can be used with a wide range of development tools including Infineon's free of charge Eclipse based IDE DAVE. The XMC4700/XMC4800 Relax Kit Series-V1 are designed to evaluate the capabilities of the XMC4700/XMC4800 Microcontroller. [Table 1](#) shows its specification.

Table 1 **Kit Specification**

Processor	Infineon's ARM® Cortex® -M4 XMC4700 or XMC4800 microcontroller in LQFP144 package (order number XMC4700-F144K2048 or XMC4800-F144K2048)
Flash Memory	2048 kB
Data Memory	352 kB
Dimensions	66 x 99 mm (66 x 101 mm with connectors)
Clock Crystals	<ul style="list-style-type: none"> • 12 MHz and 32.768 kHz crystal for CPU • 25 MHz crystal for Ethernet Phy
Power	<ul style="list-style-type: none"> • 5 V external powering • Micro-AB USB Connector interface or • On-Board Debugger USB interface
Connectors	<ul style="list-style-type: none"> • Arduino compatible connectors • All relevant XMC™ pins available on expansion pads (X1, X2) • All EtherCAT signals available on expansion pads (X1, X2) • Ethernet interface via RJ45 jac • microUSB • microSD-Card slot • Serial Wire Debug interface (2x5, 50 mil pitch) to XMC™ (on board debugger can be overridden by externally connected debugger)
Debugger	On-Board J-Link Debug Probe via USB supporting <ul style="list-style-type: none"> • Serial Wire Debug (SWD) • UART-to-USB bridge (virtual COM)
Others	<ul style="list-style-type: none"> • On-board debug probe, based on XMC4200 microcontroller • Ethernet Phy • CAN transceiver • 32 Mbit Quad-SPI Flash Memory • 2 user push-buttons, 2 user LEDs • Reset push-button

The XMC4700/XMC4800 Relax Kit Series-V1 are available in four different assembly versions differentiating in features:

- XMC4700 Relax Lite
- XMC4700 Relax for 5V Shields

1 Introduction

- XMC4700 Relax
- XMC4800 Relax EtherCAT

The XMC4700 Relax Kit and the XMC4800 Relax EtherCAT[®] Kit feature with an Ethernet-enabled communication option, for example to run an embedded web server. You can store your own HTML web pages on a microSD Card or control the XMC4700/XMC4800 via the web browser on your PC

Additional voltage level shifters and Arduino connection header on the XMC4700 Relax Kit for 5V Shields allow the usage of Arduino shields with 3.3V or 5V logic level

The embedded web server application is not supported by the XMC4700 Relax Lite Kit and the XMC4700 Relax Kit for 5V Shields, because some components for example for Ethernet and SD-Card are not assembled.

The XMC4800 Relax EtherCAT[®] Kit is assembled with a XMC4800 (pin compatible to XMC4700) and comes together with a top-mounted XMC[™] EtherCAT[®] Phy Board. It's a complete development kit for EtherCAT slave devices and the XMC4800 is powerful and functional enough to make this board an ideal choice for the development engineers of EtherCAT[®] slaves such as servo drives and intelligent I/O devices.

All boards are marked with "XMC4700/XMC4800 Relax Kit Series-V1" and can be distinguished by the assembled devices (see pictures in chapter 2). These boards are neither cost nor size optimized and do not serve as a reference design.

1.1 Key Features

Table 2 summarizes the features of the different assembly versions of the XMC4700/XMC4800 Relax Kit Series-V1.

Table 2 Kit Features of Assembly Versions

Feature	XMC4700 Relax Lite Kit	XMC4700 Relax Kit for 5V Shields	XMC4700 Relax Kit	XMC4800 Relax EtherCAT [®] Kit
XMC4700 Microcontroller	x	x	x	
XMC4800 Microcontroller				x
On-board Debug Probe with USB interface supporting SWD + SWO	x	x	x	x
Virtual COM Port via Debug Probe	x	x	x	x
2 x User Push-Buttons and 2 x User LED and 1 x Reset Push-Button	x	x	x	x
Voltage Regulator 5 V -> 3.3 V	x	x	x	x
USB (Micro USB Plug)	x	x	x	x
12 MHz Crystal	x	x	x	x
32.768 kHz RTC Crystal			x	x
Arduino compatible connector and voltage level shifter for 3.3 V / 5 V Arduino shields		x		
0 Ohm Bridges for 3.3 V Arduino shields	x		x	x
Ethernet PHY and RJ45 Jack			x	x
32 Mbit Quad-SPI Flash Memory			x	x

(table continues...)

1 Introduction

Table 2 (continued) Kit Features of Assembly Versions

Feature	XMC4700 Relax Lite Kit	XMC4700 Relax Kit for 5V Shields	XMC4700 Relax Kit	XMC4800 Relax EtherCAT® Kit
microSD Card Slot			x	x
CAN Transceiver			x	x
Pin Header at X1 and X2 with mounted XMC™ EtherCAT Phy Board				x

1.2 Block Diagram

The block diagram in [Figure 1](#) shows the main components of the XMC4700/XMC4800 Relax Kit Series-V1 and their interconnections. There are following main building blocks:

- XMC4700 / XMC4800 Microcontroller in a LQFP144 package
- On-board USB debug probe based on XMC4200 for SWD, SWV and Virtual COM Port support
- Ethernet Phy with RJ45 Plug
- Two 40-pin header X1 and X2
- Connection Header for Arduino
- On-board power generation
- 2 User Push-Buttons, 2 User LEDs, Reset Push-Button
- Micro-AB USB Plug
- microSD Card Slot
- CAN Transceiver
- Quad SPI Flash

2 Hardware Description

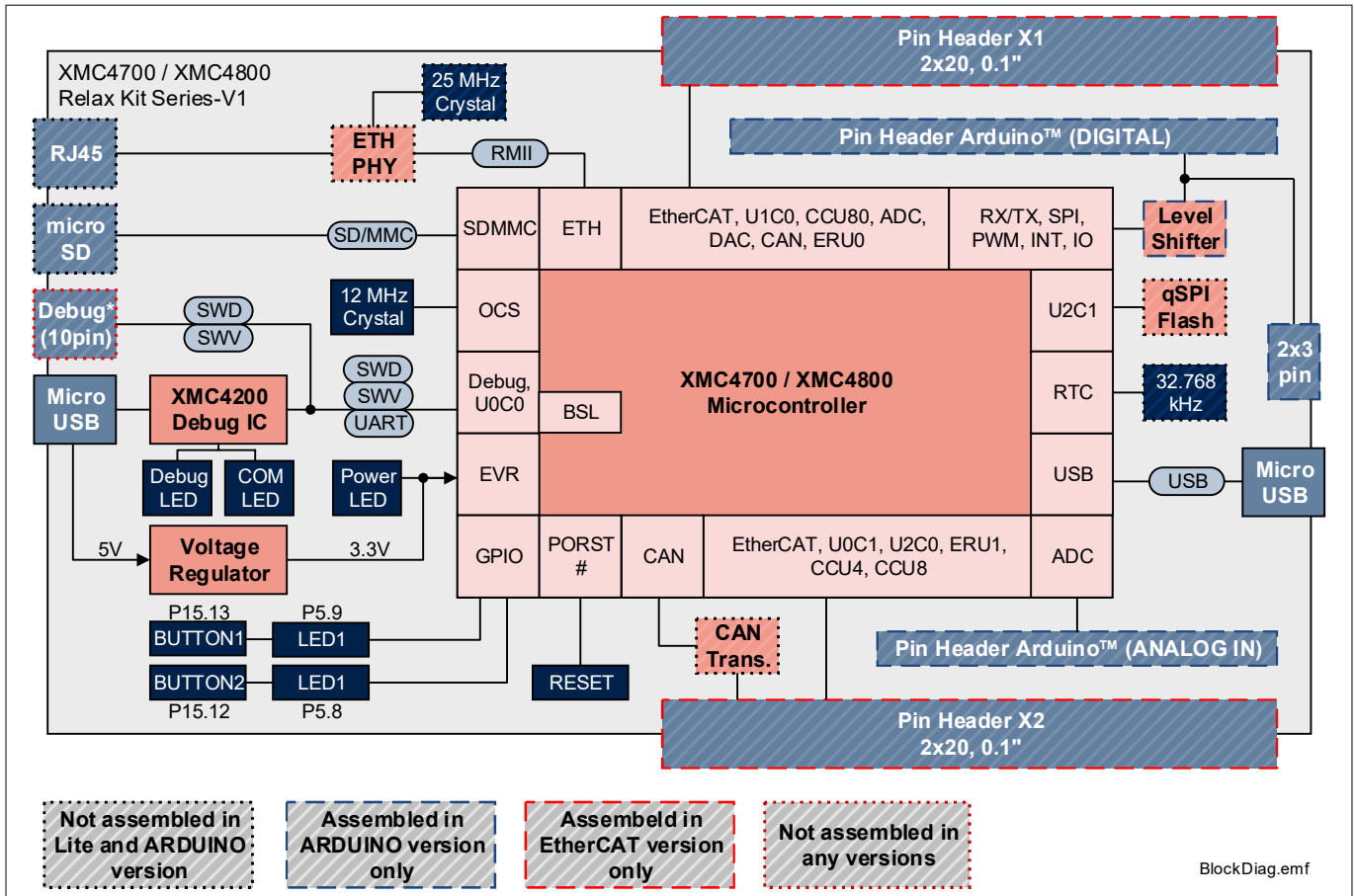

Figure 1 Block Diagram of the XMC4700/XMC4800 Relax Kit Series-V1

2 Hardware Description

The following chapters give a detailed description of the board hardware and how it can be used. The different assembly versions of the kits series are shown in [Figure 2](#), [Figure 3](#), [Figure 4](#) and [Figure 5](#).

2 Hardware Description

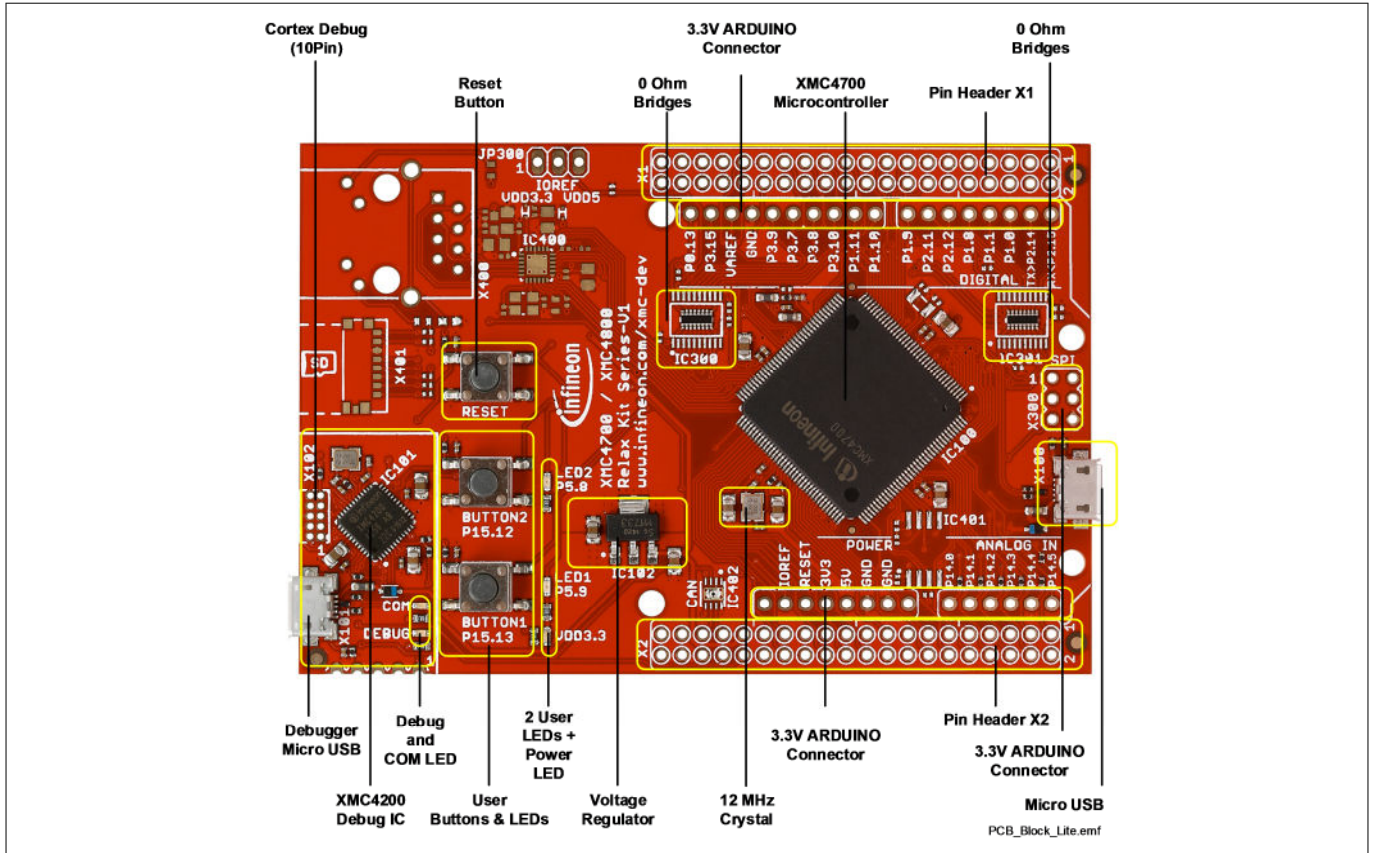

Figure 2 XMC4700 Relax Lite Kit

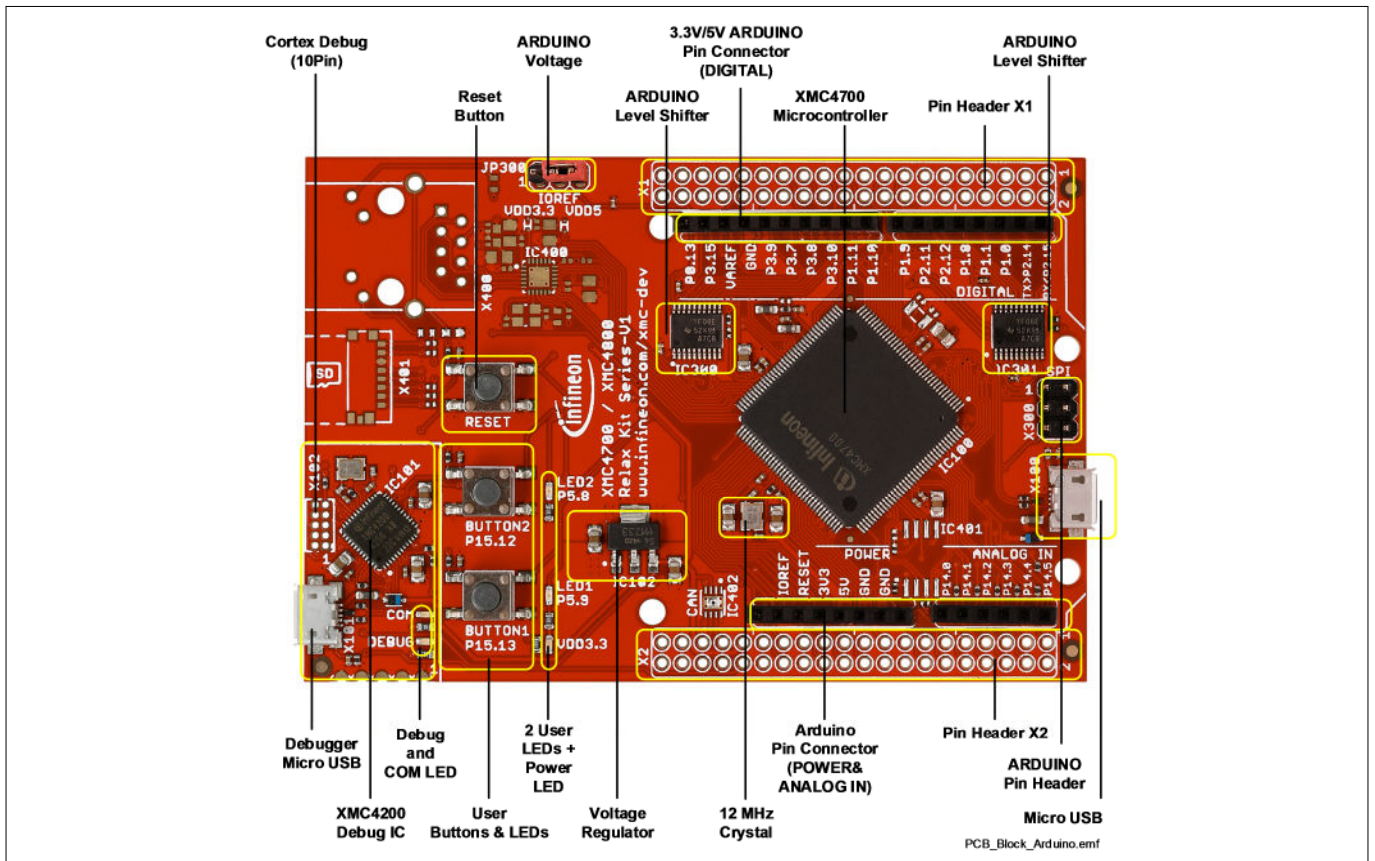

Figure 3 XMC4700 Relax Kit for 5V Shields

2 Hardware Description

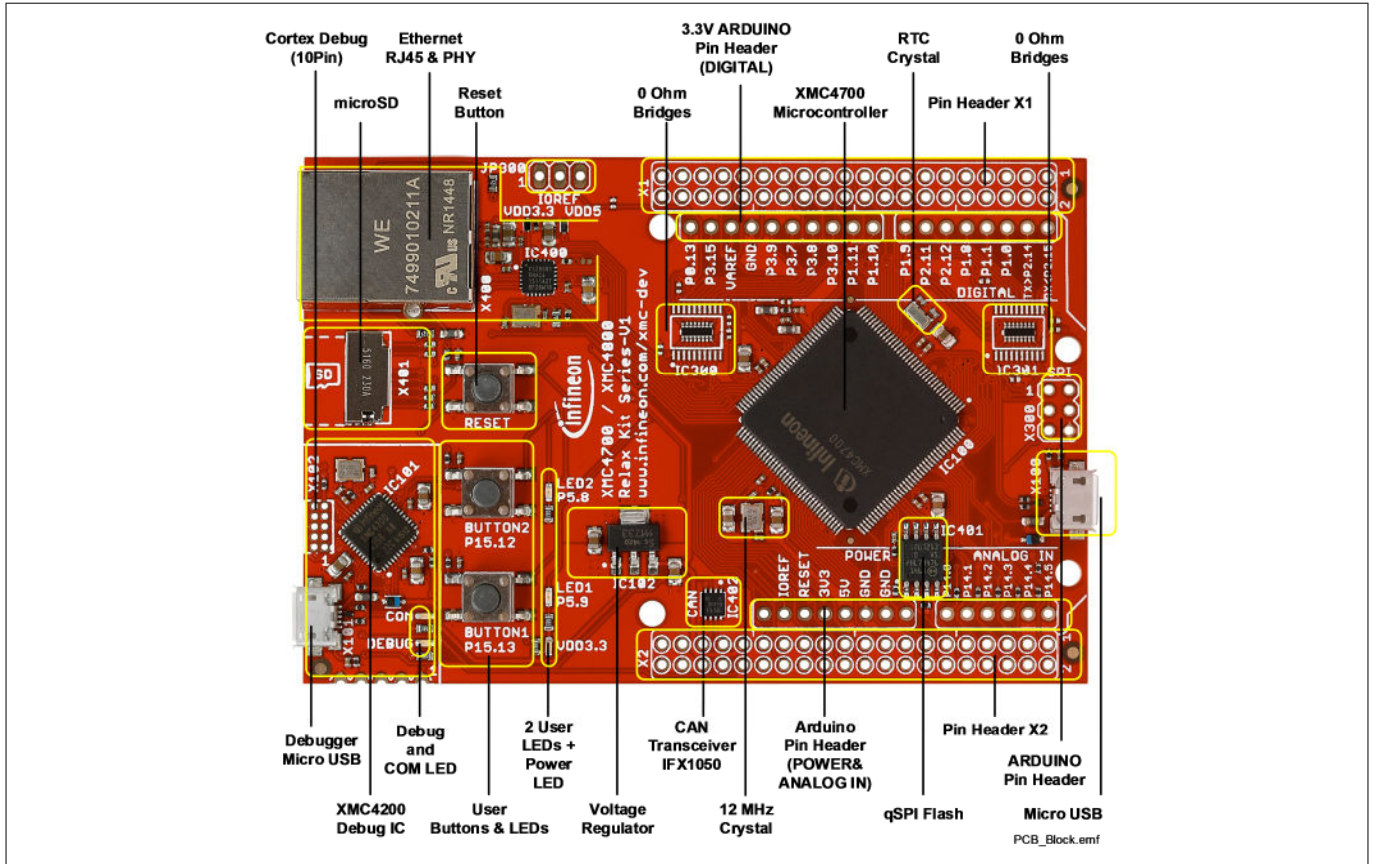

Figure 4 XMC4700 Relax Kit

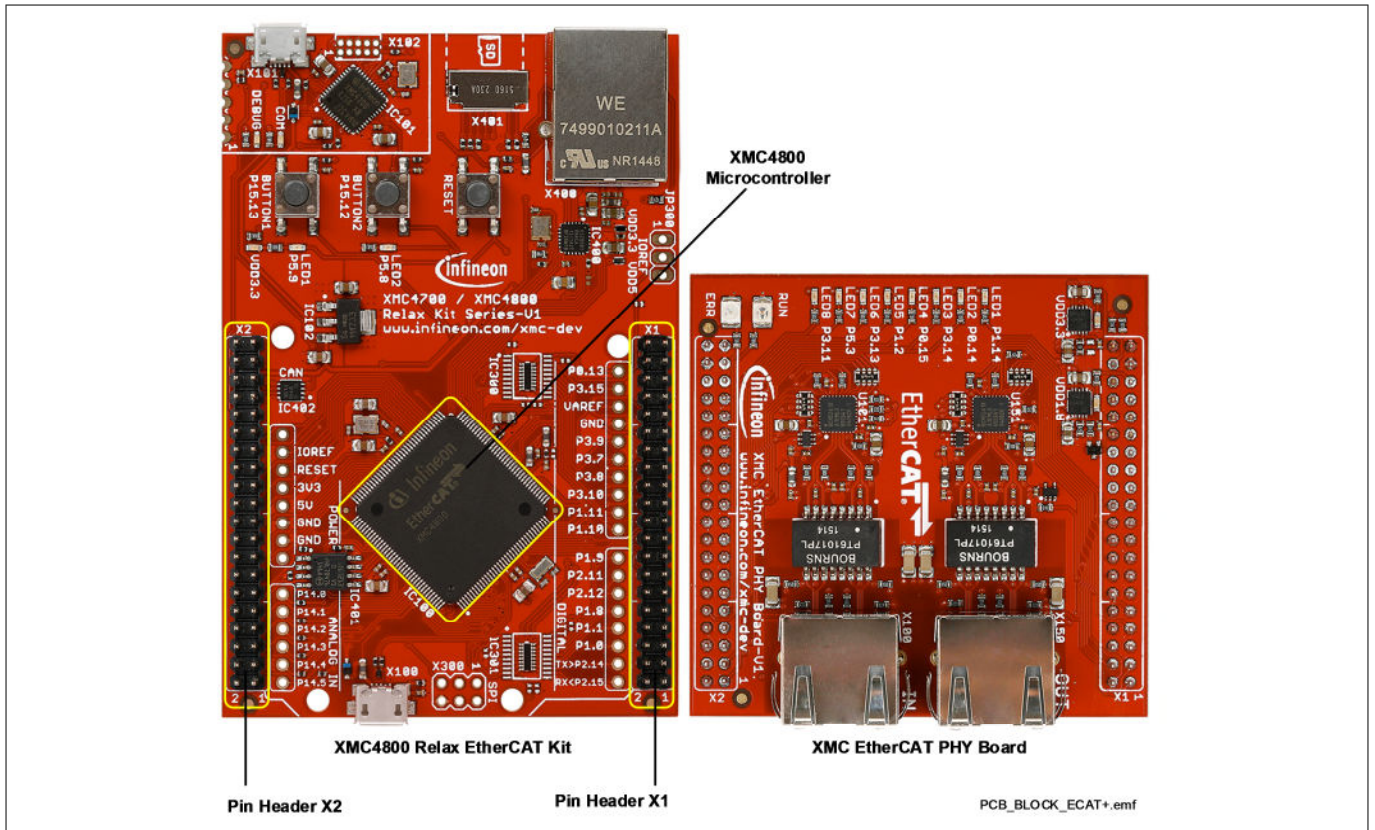

Figure 5 The XMC4800 Relax EtherCAT Kit includes the XMC™ EtherCAT PHY Board

2 Hardware Description

2.1 Power Supply

The XMC4700/XMC4800 Relax Kit Series-V1 must be supplied by an external 5 Volt DC power supply connected to any of the micro USB plugs (X100, X101). Out of the box with the pre-programmed web server application and the on-board debug probe in operation the XMC4700 Relax Kit typically draws about 250 mA, the XMC4700 Relax Lite Kit and the XMC4700 Relax Kit for 5V Shields without the web server capabilities draws about 200 mA and the XMC4800 Relax EtherCAT Kit together with the XMC™ EtherCAT Phy Board in an EtherCAT network draws about 500 mA. This current can be delivered via the USB plug of a PC, which is specified to deliver up to 500 mA. The green Power LED (VDD3.3) indicates the presence of the generated 3.3 V supply voltage.

On-board reverse current protection diodes will ensure safe operation in case power is provided through both USB plugs at the same time. These protection diodes allows to use the on-board debug probe connected with a PC/Notebook via X101 and a second host PC/Laptop connected with the XMC4700 / XMC4800 Relax Kit via X100. If the board is powered via a USB plug, it's not recommended to apply an additional 5 Volt power supply to one of the 5 Volt power pins (VDD5, 5 V) on the pin headers X1 or X2 or the Arduino Power header, because there is no protection against reverse current into the external power supply. These power pins can be used to power an external circuit. But care must be taken not to draw more current than USB can deliver. A PC as USB host typically can deliver up to 500 mA current. If higher currents are required and in order to avoid damages on the USB host the use of an external USB power supply unit which is able to deliver higher currents than 500 mA is strongly recommended.

After power-up the green DEBUG LED starts blinking. In case there is a connection to a PC via the Debug USB plug X101 and the USB Debug Device drivers are installed on this PC, the DEBUG LED will turn from blinking to constant illumination.

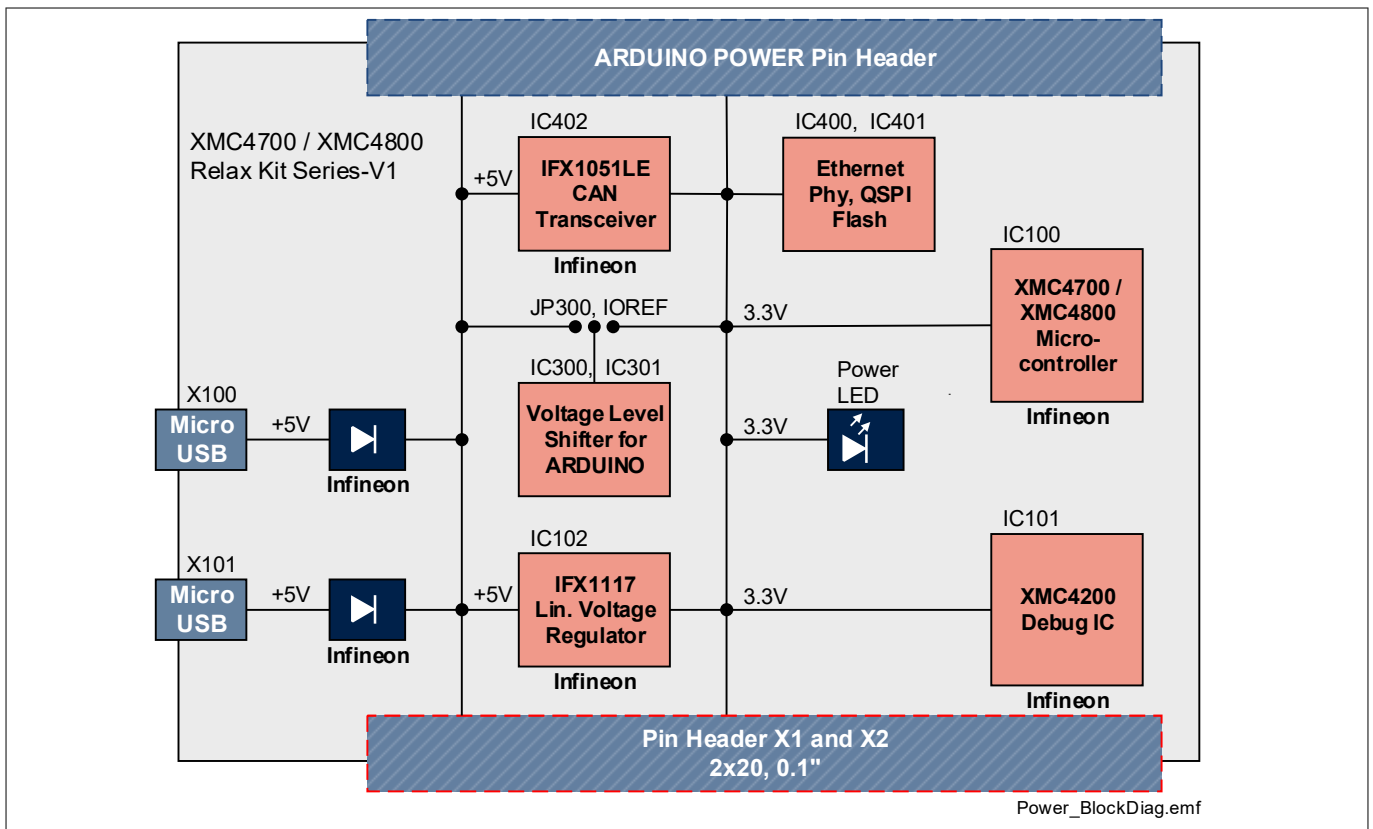

Figure 6 Power Supply Concept

2 Hardware Description

2.2 Pin Header X1 and X2

The pin headers X1 and X2 can be used to extend the evaluation board or to perform measurements on the XMC4700 / XMC4800. [Figure 7](#) shows the available GPIOs / signals at these pin headers. The pin table is also printed onto the bottom side of the PCB.

Pin Header X2				Pin Header X1			
GND	40	39	GND	GND	40	39	GND
GND	38	37	GND	VDD3.3	38	37	GND
VDD3.3	36	35	CANL	VDD3.3	36	35	VDD5
VDD3.3	34	33	CANH	P5.11	34	33	P5.10
RST#	32	31	VDD5	P1.14	32	31	P2.13
HIB_1	30	29	HIB_0	P14.8	30	29	P14.9
P2.6	28	27	P5.7	P15.14	28	27	P15.15
P5.6	26	25	P5.5	P14.6	26	25	P14.7
P5.4	24	23	P5.3	P14.12	24	23	P14.13
P5.2	22	21	P5.1	P14.14	22	21	P14.15
P5.0	20	19	P1.15	P15.2	20	19	P15.3
P6.6	18	17	P6.5	P15.4	18	17	P15.5
P6.4	16	15	P6.3*	P15.7	16	15	P15.6
P6.2	14	13	P6.1	P3.0	14	13	P3.1
P6.0	12	11	P1.2	P0.9	12	11	P3.2
P0.8	10	9	P0.7	P0.0	10	9	P0.10
P3.3	8	7	P3.14	P0.2	8	7	P0.1
P0.15	6	5	P0.14	P0.4	6	5	P0.3
P0.12	4	3	P3.11	P0.6	4	3	P0.5
P3.12	2	1	P3.13	P0.11	2	1	P3.4

(Top View)

Figure 7 Signal mapping of the pin headers X1 and X2

* The silkscreen on the PCB of this pin is wrong: It says “P5.3” (wrong) instead of “P6.3” (right). PCB version 1 is affected only.

2.3 Arduino Compatible Connector

The mapping of GPIOs and XMC™ pin functions to Arduino compatible functions can be found in [Figure 8](#). The Arduino compatible connector supports

- SPI interface (SPI_XXX)
- I2C interface (I2C_XXX)
- UART interface (UART_XXX)
- PWM signal outputs (PWM0-5)
- ADC input (ADC0-5)
- Interrupt input (INT0-1)

2 Hardware Description

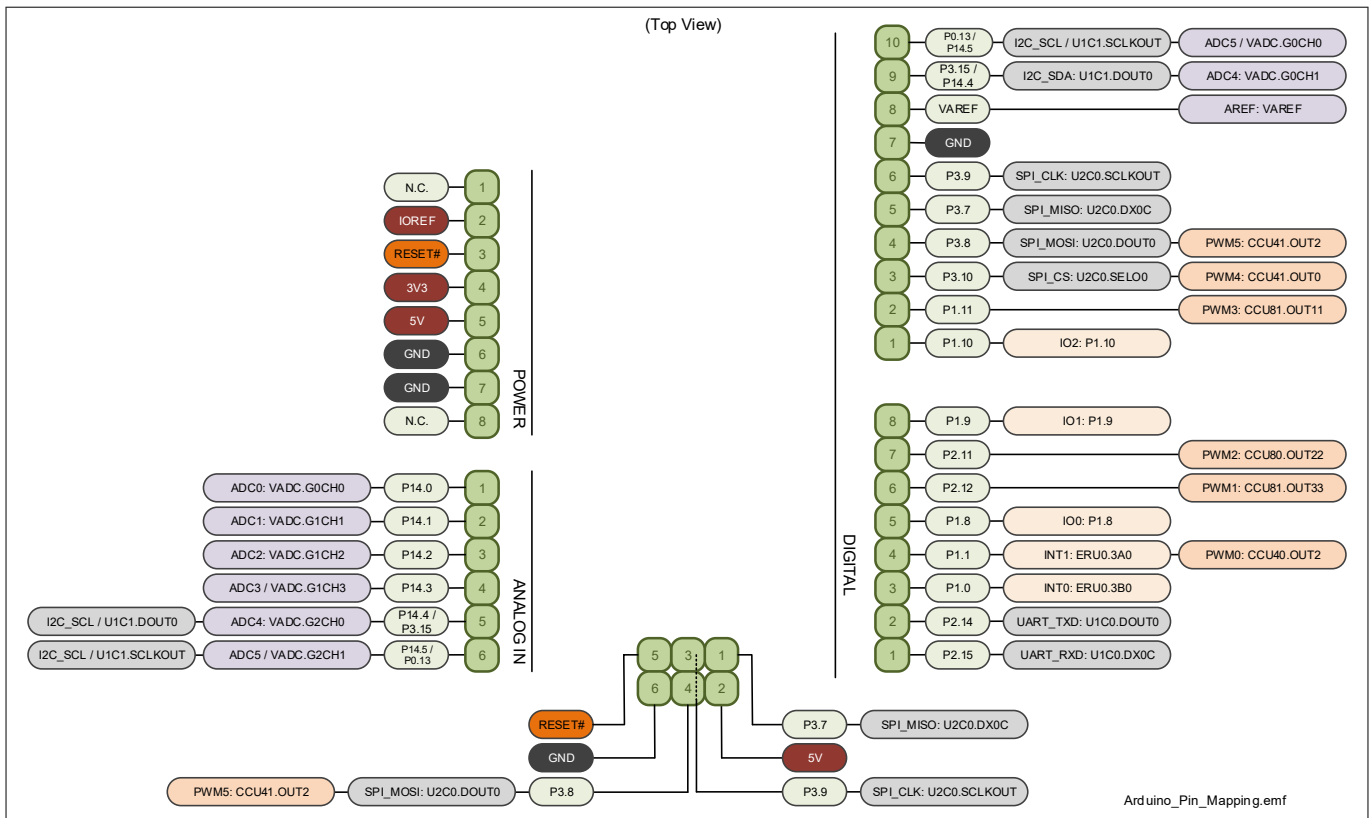

Figure 8 Mapping of Arduino Functions to XMC™ Pin Functions

The XMC4700 Relax Kit for 5V Shields features bi-directional voltage level shifter and therefore supports 5 V Arduino shields. Jumper JP300 (IOREF) determines whether the Arduino shield is driven with 5 V or 3.3 V. Analog input signals ADC0-5 are limited to 3.3 V input voltage. Primarily ADC0 to ADC3 should be used as analog input, because there is no additional circuit connected to these pins, whereas ADC4 and ADC5 have additional circuitry and require an input signal with lower input impedance.

Note: Parallel operation of I2C and ADC4 / ADC5 is not possible, because they share the same Arduino pins.

2.4 User Push Buttons and User LEDs

The XMC4700/XMC4800 Relax Kit Series-V1 provides two push buttons and two LEDs. The port pins used can be found in [Table 3](#) and [Table 4](#). These pins are used exclusively for this function and they are not mapped to other devices or connectors.

Table 3 XMC4700/XMC4800 Pin Mapping for User LEDs

LED	XMC™ Pin
LED1	P5.9
LED2	P5.8

Table 4 XMC4700/XMC4800 Pin Mapping for User Push Buttons

Button	XMC™ Pin
BUTTON1	P15.13
BUTTON2	P15.12

2 Hardware Description

2.5 Debugging and UART-to-USB Communication

The XMC4700/XMC4800 Relax Kit Series-V1 supports debugging via 2 different channels:

- On-board debug probe
- 10-pin Cortex™ Debug Connector (not assembled)

2.5.1 On-board Debug Probe

The on-board debug probe supports Serial Wire Debug (SWD) and UART communication. Both require the installation of Segger's J-Link Driver which is part of the DAVE™ installation. DAVE™ is a highly efficient development platform for the XMC™ microcontroller families to simplify and shorten SW development. It can be downloaded at www.infineon.com/dave. The latest Segger J-Link Driver can be downloaded at <http://www.segger.com/jlink-software.html>. Table 5 shows the pin assignment of the XMC4700/XMC4800 used for debugging and UART communication.

Table 5 XMC4700/XMC4800 Pins Mapping for Debugging and UART-Communication

Pin Funtion	Input/Output	XMC™ Pin
Data pin for Debugging via SWD	I/O	TMS
Clock pin for Debugging ia SWD	O	TCK
Transmit pin for UART communication (PC_RX)	O	P1.5 (U0C0.DOUT)
Receive pin for UART communication (PC_TX)	I	P1.4 (U0C0.DX0B)

2.5.2 Cortex™ Debug Connector (10-pin)

The 10-pin Cortex™ Debug Connector supports Serial Wire Debug (SWD) and Serial Wire Viewer (SWV). The pin assignment of the Cortex™ Debug Connector is shown in Table 6.

Table 6 Pin Assignment of the Cortex™ Debug Connector (X102)

Pin No.	Signal Name	Description
1	VCC	+3.3 V
2	TMS	Serial Wire Data I/O
3	GND	Ground
4	TCK	Serial Wire Clock
5	GND	Ground
6	SWV	Serial Wire Viewer (Trace Data Out)
7	Key	Key
8	NC	Not connected
9	GND_Detect	Ground detected
10	RESET	Rest (active low)

2 Hardware Description

2.6 Reset

The reset pin (PORST#) of the XMC4700/XMC4800 is a bi-directional pin in open drain mode. An internal pull-up resistor keeps the PORST# pin high during normal operation. A low level at this pin will force a hardware reset. In case of a MCU internal reset the PORST# pin will drive a low signal.

A reset signal can be issued by

- the on-board Reset Button (SW102, “RESET”)
- the on-board debug probe (IC101.46)
- the external debugger connected to the 10-pin Cortex™ Debug probe connector (X102)
- the Arduino Power Header (X302.3, “RESET”)
- the pin header X2 (X2.32, “RST#”)

An XMC™ internal circuit always ensures a save Power-on-Reset. XMC™ does not require any additional external components to generate a reset signal during power-up.

2.7 CAN Transceiver

The XMC4700 Relax Kit and the XMC4800 Relax EtherCAT Kit provide a CAN interface via the X2 connector. Infineon’s high speed CAN transceiver IFX1051LE for industrial application supports 3.3V I/O logic and is suitable for 12V and 24V bus systems with an excellent EMC performance. The CAN bus (signals CANH, CANL) is not terminated by a 120 Ohm and needs to be terminated externally.

Table 7 CAN Signals and XMC4700/XMC4800 Pin Mapping

Signal name	Pin No. at Pin Header X2	XMC™ Pin, XMC™ Function
CANH	X2.33	–
CANL	X2.35	–
CAN_TX	–	P1.12, CAN.N1_TXD
CAN_RX	–	P1.13, CAN.N1_RXDC

2.8 Serial Flash Memory

The XMC4700 Relax Kit and the XMC4800 Relax EtherCAT Kit provide a 32 Mbit serial flash memory from Micron (type: N25Q032A) interfaced to XMC4700/XMC4800 through a SPI interface. The SPI interface can be configured as single, dual or quad SPI.

Table 8 XMC4700/XMC4800 Pins Mapping for Serial Flash Memory

XMC™ Pin	Function in qSPI Mode, XMC™ Function	Function in SPI Mode, XMC™ Function
P4.2	Clock, U2C1.SCLKOUT	Clock, U2C1.SCLKOUT
P4.3	Chip Select, U2C1.SELO2	Chip Select, U2C1.SELO2
P4.7	Data Line 0 I/O, U2C1.DOUT0	Master Out Slave In (MOSI, MTSR), U2C1.DOUT0
P4.6	Data Line 1, U2C1.DOUT1	Master In Slave Out (MISO, MRST), U2C1.DX0E
P4.4	Data Line 3, U2C1.DOUT3	HOLD (low active)
P4.5	Data Line 2, U2C1.DOUT2	Write Protection (low active)

2 Hardware Description

2.9 microSD Card

The XMC4700 Relax Kit and the XMC4800 Relax EtherCAT Kit provide a microSD card slot (X401). The microSD card can be operated in SD mode via the SDMMC peripheral or in SPI mode via the USIC0 Channel1 (U0C1) of the XMC4700/XMC4800.

Table 9 XMC4700/XMC4800 Pins Mapping for microSD Card

XMC™ Pin	Function in SD Mode, XMC™ Function	Function in SPI Mode, XMC™ Function
P3.6	Clock, SDMMC.CLK_OUT (IN)	Clock, U0C1.SCLKOUT
P3.5	Command Line, SDMMC.CMD_OUT (IN)	Master Out Slave In (MOSI, MTSR), U0C1.DOUT0
P4.0	Data Line 0, SDMMC.DATA0_OUT (IN)	Master In Slave Out (MISO, MRST), U0C1.DX0E
P1.6	Data Line 1, SDMMC.DATA1_OUT (IN)	Unused
P1.7	Data Line 2, SDMMC.DATA2_OUT (IN)	Unused
P4.1	Data Line 3, SDMMC.DATA3_OUT (IN)	Chip Select (CS) / Slave Select (SS), U0C1.SELO0

2.10 Ethernet

The XMC4700 Relax Kit and the XMC4800 Relax EtherCAT Kit provide an Ethernet Phy and RJ45 plug.

Table 10 XMC4700/XMC4800 Pins used for Ethernet

XMC™ Pin	Ethernet Function	XMC™ Function
P15.9	Carrier Sense / Receive Data Valid	ETH0.CRS_DVC
P15.8	Clock Input	ETH0.CLK_RMIIC
P2.10	LED	GPIO P2.10
P2.9	Transmit Data Line 1	ETH0.TXD1
P2.8	Transmit Data Line 0	ETH0.TXD0
P2.5	Transmit Enable	ETH0.TX_EN
P2.4	Receive Error	ETH0.RXERA
P2.3	Receive Data Line 1	ETH0.RXD1A
P2.2	Receive Data Line 0	ETH0.RXD0A
P2.0	Management Data In/Out	ETH0.MDIB / ETH0.MDO
P2.7	Management Data Clock	ETH0.MDC
P1.3	Interrupt (disabled via solder jumper R401)	GPIO P1.3

3 Production Data

2.11 Boot Option

During power-on-reset the XMC4700/XMC4800 latches the signal level at the pins TMS and TCK. Based on the logic levels latched at these pins after reset the XMC4700/XMC4800 starts booting in different modes. TMS and TCK pins are used for debugging and by default program execution is always starting from on-chip flash (normal mode).

The XMC4700/XMC4800 Relax Kit Series-V1 does not support the selection of the boot options by switches directly. In case of no external debug probe is used the boot mode can be influenced by applying 1 kOhm pull-up- or pull-down resistors to TMS and TCK pins. These pins are available at the 10-pin debug connector X102.

Table 11 Boot Mode Selection with external Pull Resistors

Logic Level at TMS during Reset	Logic Level at TCK during Reset	Boot Mode
High	Low	Normal Mode (boot from on-chip flash) (DEFAULT)
Low	Low	ASC BSL Mode (boot from UART)
High	High	BMI Customized Boot Mode
Low	High	CAN BSL Mode (boot from CAN)

3 Production Data

This chapter covers schematics, board dimensions, component placement and the list of material.

3.1 Schematics

In the following figures shows the schematics of the XMC4700/XMC4800 Relax Kit Series-V1 and the XMC™ EtherCAT Phy Board-V1:

- [Figure 9](#): Relax Kit Schematic: MCU, Push Buttons, LEDs, Reset Button, Crystals, USB
- [Figure 10](#): Relax Kit Schematic: OBD Probe, Ethernet, Quad-SPI Memory, microSD Card Slo
- [Figure 11](#): Relax Kit Schematic: Pin Header, Voltage Level Shifter, Power Supply, CAN transceiver
- [Figure 12](#): XMC™ EtherCAT Phy Board Schematic: Input and Output Phy
- [Figure 13](#): XMC™ EtherCAT Phy Board Schematic: Power, Connectors, LEDs
- [Figure 14](#): XMC™ EtherCAT Phy Board Schematic: Input and Output Phy (see Revision 1.3)
- [Figure 15](#): XMC™ EtherCAT Phy Board Schematic: Power, Connectors, LEDs (see Revision 1.3)
- [Figure 16](#): XMC™ EtherCAT Phy Board Schematic: Input and Output Phy (see Revision 1.4)
- [Figure 17](#): XMC™ EtherCAT Phy Board Schematic: Power, Connectors, LEDs (see Revision 1.4)

3 Production Data

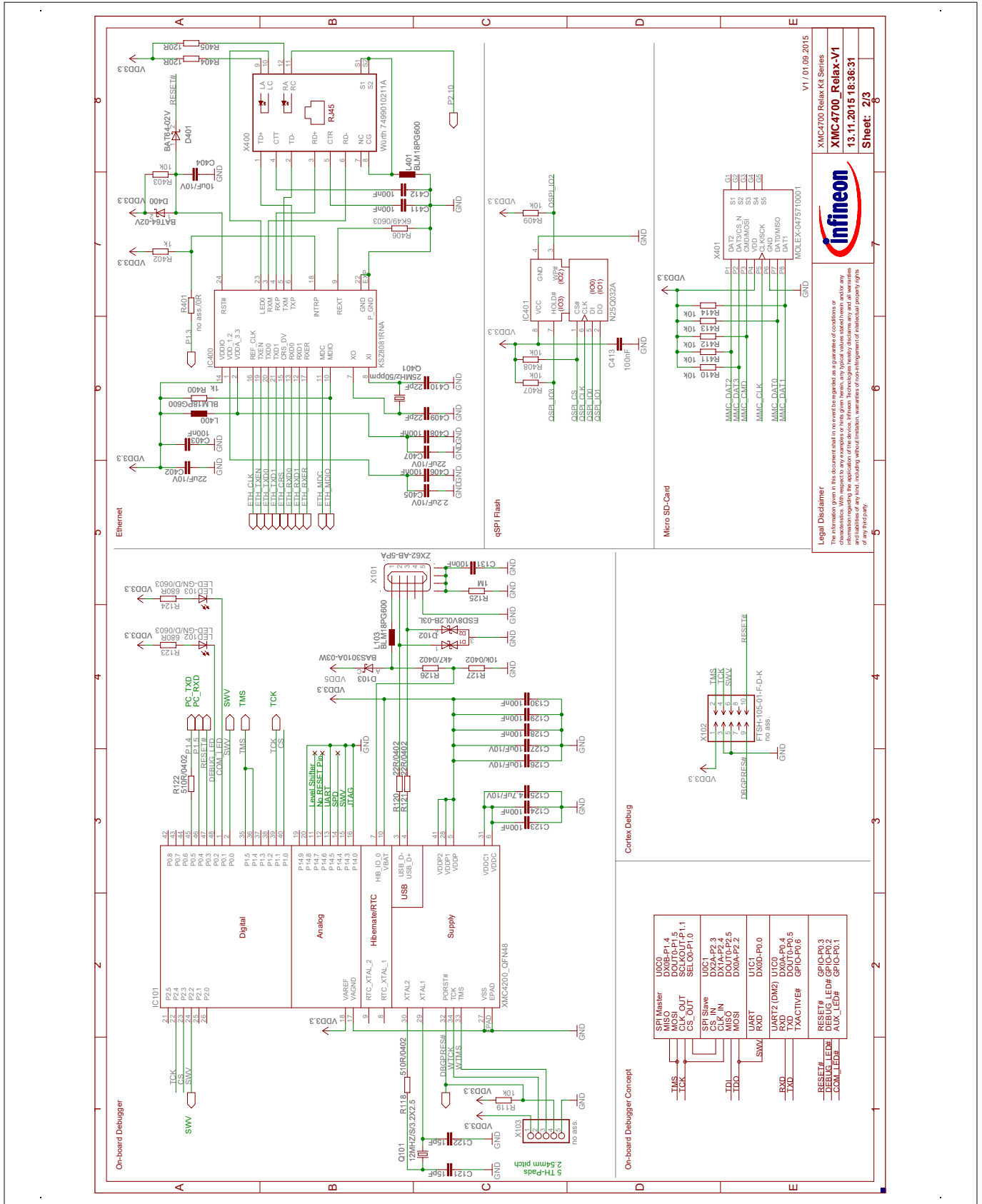

Figure 10 Relax Kit Schematic: OBD Probe, Ethernet, Quad-SPI Memory, microSD Card Slot

3 Production Data

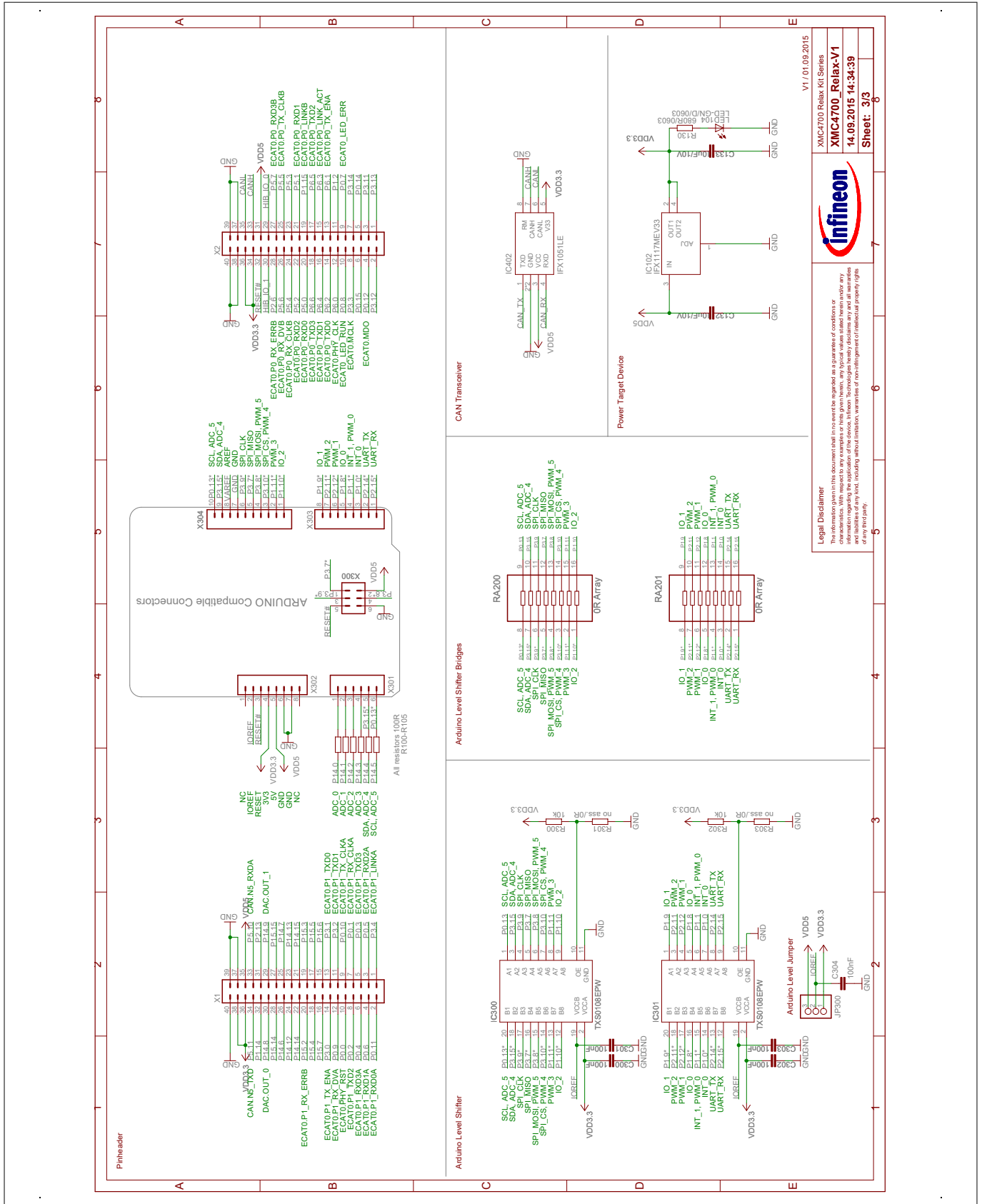
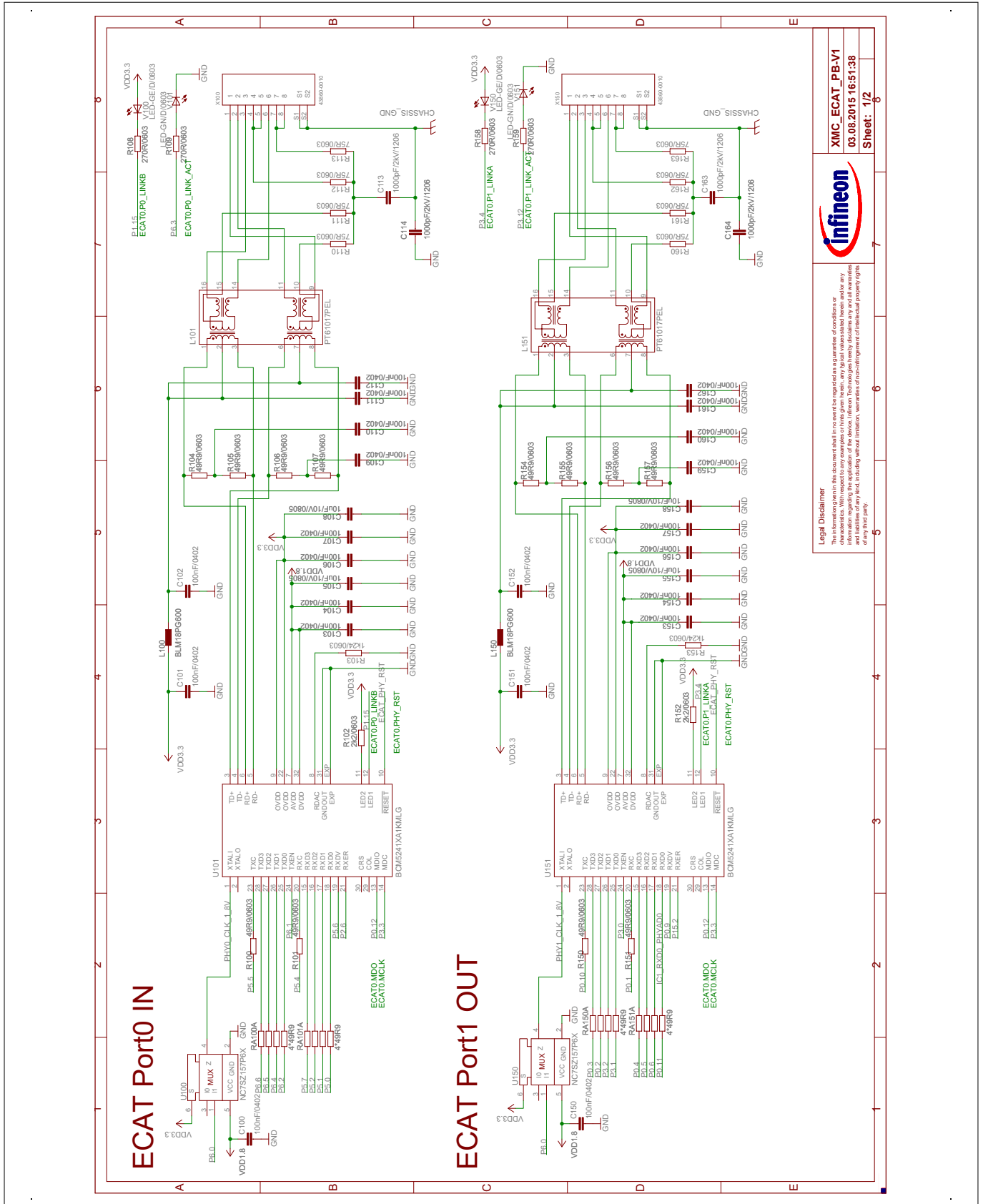

Figure 11 Relax Kit Schematic: Pin Header, Voltage Level Shifter, Power Supply, CAN transceiver

3 Production Data



Infineon

XMC_ECAT_PB-V1
03.08.2015 16:51:38
Sheet: 1/2

Legal Disclaimer
The information in this document is intended to provide a general overview of the product and is not intended to be used for any specific application. The information is provided "as is" and without warranty of any kind, including without limitation, warranties of non-infringement, intellectual property rights, or otherwise. The user assumes all responsibility for any infringement or any other damages that may arise from the use of the information in this document.

Figure 12 XMC™ EtherCAT Phy Board Schematic: Input and Output Phy

3 Production Data

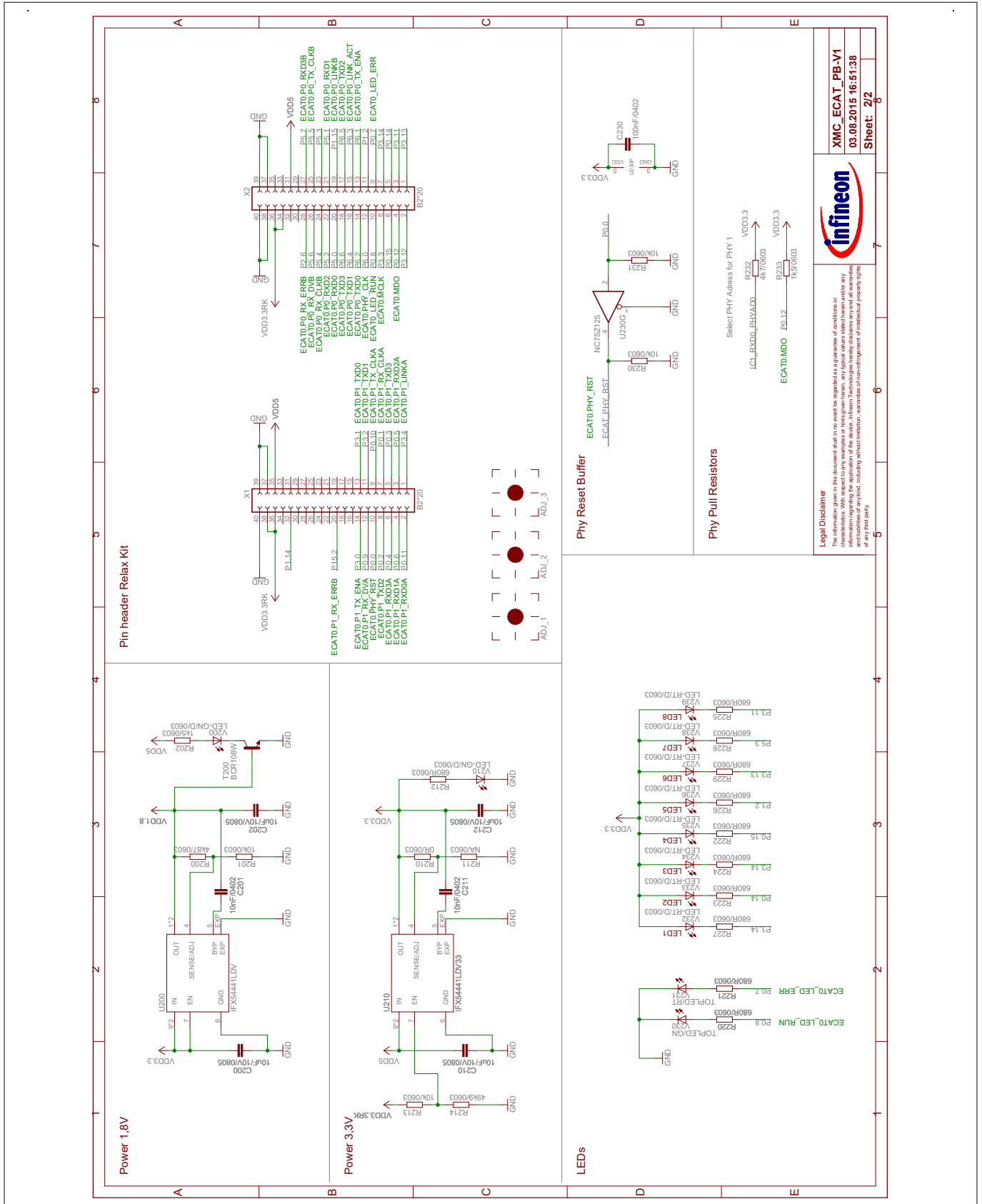
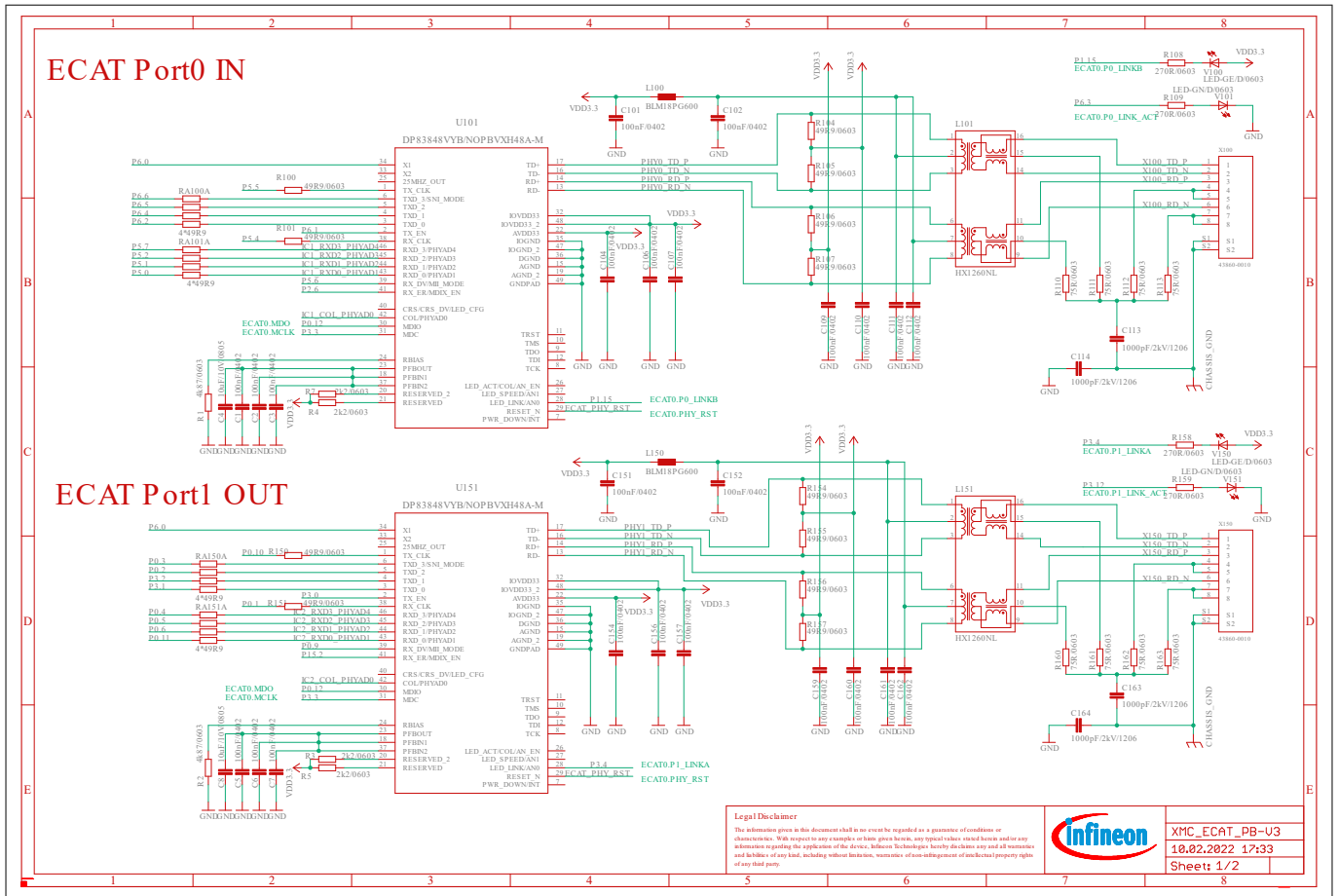

Figure 13 XMC™ EtherCAT Phy Board Schematic: Power, Connectors, LEDs

3 Production Data



Legal Disclaimer

The information given in this document shall in no event be regarded as a guarantee of conditions or characteristics. With respect to any examples or drawings herein, any typical values cannot be used for any information regarding the application of the device. Infineon Technologies hereby disclaims any and all warranties and liabilities of any kind, including without limitation, those of non-infringement of intellectual property rights of any third party.



XMC_ECAC_PB-U3
10.02.2022 17:33
Sheet: 1/2

Figure 14 XMC™ EtherCAT Phy Board Schematic: Input and Output Phy (see Revision 1.3)

3 Production Data

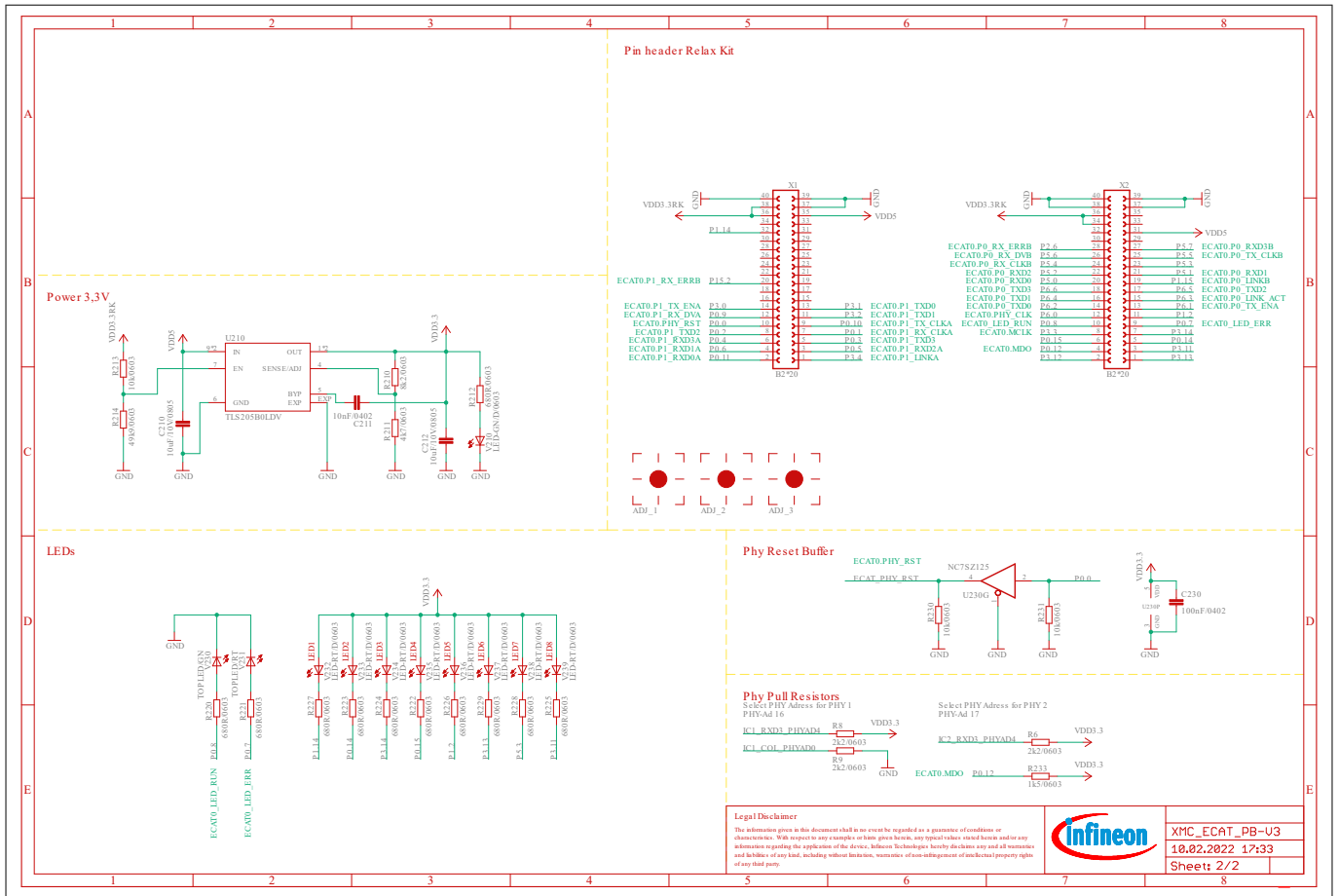

Figure 15 XMC™ EtherCAT Phy Board Schematic: Power, Connectors, LEDs (see Revision 1.3)

3 Production Data

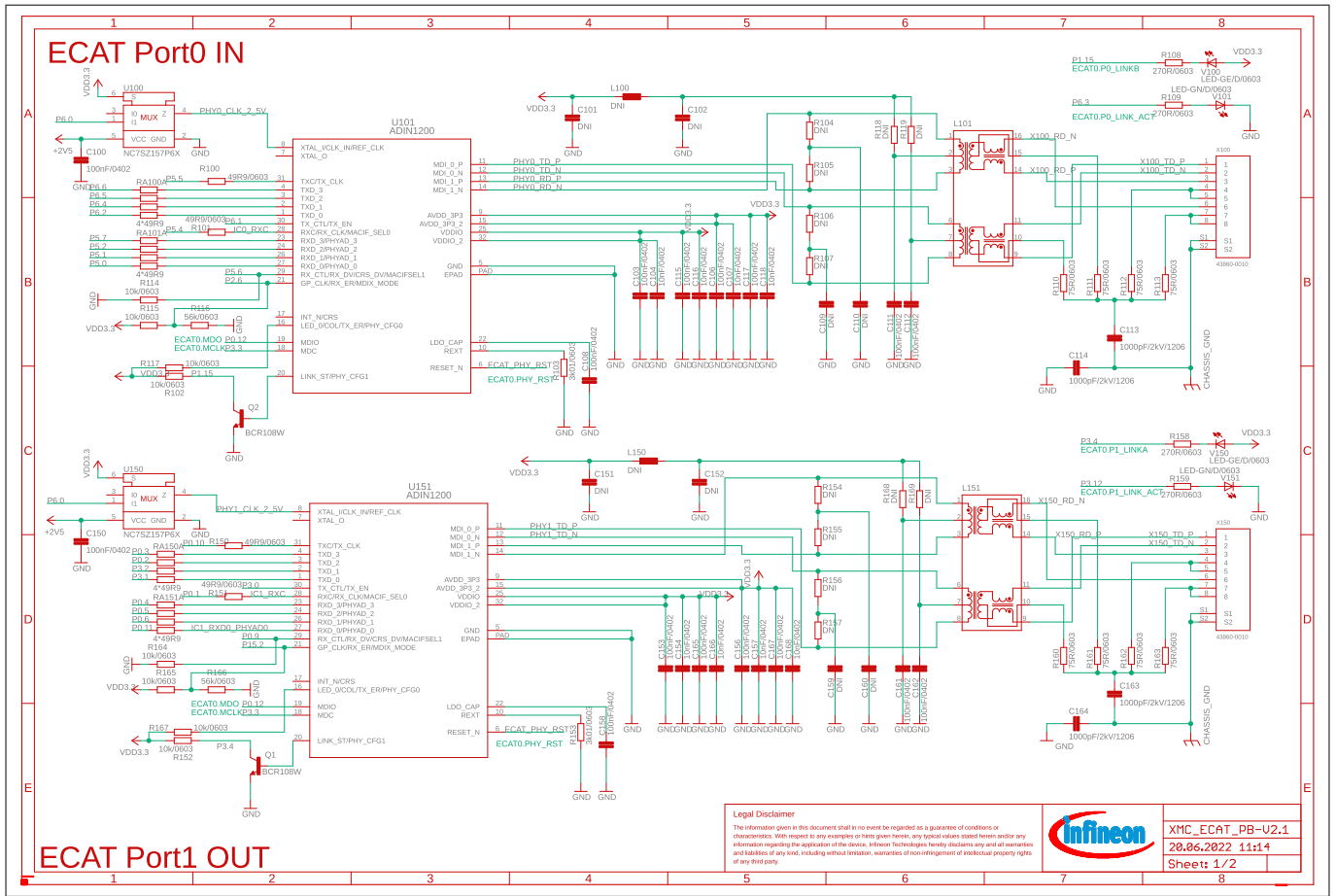

Figure 16 XMC™ EtherCAT Phy Board Schematic: Input and Output Phy (see Revision 1.4)

3 Production Data
Table 12 (continued) List of Material

Value	Device	Qty	Reference Designator	Note ¹⁾
22uF 10V 20% 0805	Capacitor X5R	2	C402, C407	B
100nF 16V 10% 0402	Capacitor X7R	19	C100, C105, C106, C107, C108, C109, C110, C111, C112, C114, C115, C118, C119, C123, C124, C128, C129, C130, C131	
100nF 16V 10% 0402	Capacitor X7R	5	C300, C301, C302, C303, C304	A
100nF 16V 10% 0402	Capacitor X7R	6	C403, C406, C408, C411, C412, C413	B
10nF 16V 10% 0402	Capacitor X7R	1	C120	
2.2uF 10V 10% 0805	Capacitor X7R	1	C405	B
4.7uF 10V 10% 0805	Capacitor X7R ESR<50mOhm	1	C125	
10-pin	Connection Header 10-pin 0.1" THT SSW-110-01-G-S	1	X304	A
6-pin	Connection Header 6-pin 0.1" THT SSW-106-01-G-S	1	X301	A
8-pin	Connection Header 8-pin 0.1" THT SSW-108-01-G-S	2	X302, X303	A
RJ45	Connector 10/100 Ethernet 7499010211A Wüth	1	X400	B
ZX62-AB-5PA	Connector Micro USB AB SMD ZX62- AB-5PA Hirose	2	X100, X101	
microSD-Card Slot	Connector microSD MOLEX-475710001	1	X401	B
12MHz 3.2x2.5	Crystal 12MHz 4Pad NX3225SA 12MHz NDK	2	Q100, Q101	
25MHz 3.2x2.5	Crystal 25MHz 4Pad NX3225SA 25MHz NDK	1	Q401	B
32.768KHz 3.2x1.5	Crystal 32.768KHz SMD 12.5pF NDK NX3215SA-32.768K	1	Q400	B
BAT64-02V SC79	Diode Infineon	2	D400, D401	B
BAS3010A-03W SOD323	Diode Schottky 30V 1A Infineon	2	D101, D103	
KSZ8081RNACA QFN24	Ethernet PHY RMII Micre	1	IC400	B
BLM18PG600SN1D 0603	Ferrite Bead 60R 500mA Murata	4	L100, L101, L102, L103	
BLM18PG600SN1D 0603	Ferrite Bead 60R 500mA Murata	2	L400, L401	B
N25Q032A13ESE40 SO8W	Flash serial SPIx4 32-Mbit Micron	1	IC401	B
LED-GN 0603	LED SMD gn LSQ971-Z	3	LED102, LED103, LED104	

(table continues...)

3 Production Data
Table 12 (continued) List of Material

Value	Device	Qty	Reference Designator	Note ¹⁾
LED-RT 0603	LED SMD rt LSQ976-Z	2	LED100, LED101	
TXS0108EPW TSSOP-20	Level Shifter 8-bit	2	IC300, IC301	A
XMC4200-Q48K256 QFN48	Microcontroller XMC4200 Infineon	1	IC101	
XMC4700/XMC4800- F144F2048 LQFP144	Microcontroller XMC4700/ XMC4800 Infineon	1	IC100	
2x20pin 0.1"	Pin Header THT	2	X1, X2	C
2x3-pin 0.1	Pin Header THT	1	X300	A
3-pin 0.1"	Pin Header THT	1	JP300	A
no ass. 2x5pin 0.05"	Pin Header THT FTSH-105-01-F- D-K	1	X102	N
no ass. 5-pin 0.1"	Pin Header THT no assembly	1	X103	N
ESD8V0L2B-03L TSLP-3- 1	Diode Protection Infineon	2	D100, D102	
FSM2JSMA	Pushbutton ON SMD Tyco	3	SW100, SW101, SW102	
0R 1% 0402	Resistor	1	R110	
100R 1%0 402	Resistor	6	R100, R101, R102, R103, R104, R105	
10K 1% 0402	Resistor	5	R114, R115, R116, R119, R127	
10k 1% 0402	Resistor	2	R300, R302	A
10k 1% 0402	Resistor	9	9 R403, R407, R408, R409, R410, R411, R412, R413, R414	B
120R 1% 0603	Resistor	2	R404, R405	B
1k 1% 0402	Resistor	2	R400, R402	B
1M 1% 0402	Resistor	2	R106, R125	
22R 1% 0402	Resistor	2	R107, R108	
22R 1% 0402	Resistor	2	R120, R121	
4k7 1% 0402	Resistor	1	R126	
510R 1% 0402	Resistor	3	R111, R118, R122	
680R 1% 0603	Resistor	4	R112, R113, R123, R124	
680R 1% 0603	Resistor	1	R130	
6K49 1% 0603	Resistor	1	R406	B
no ass. 0R	Resistor	4	R109, R301, R303, R401	N
0R 0402 Array	Resistor Network EXB2HVR000V Panasonic	2	RA200, RA201	D

(table continues...)

Revision history
Table 12 (continued) List of Material

Value	Device	Qty	Reference Designator	Note ¹⁾
IFX1117MEV33 SOT223	Voltage Regulator 3.3 V Infineon	1	IC102	

1) Agenda:

A: Assembled on Relax Kit for 5V Shields only

B: Assembled on Relax Kit and Relax EtherCAT Kit only

C: Assembled on Relax EtherCAT Kit only

D: Assembled on Relax Kit , Relax Lite Kit and Relax EtherCAT Kit only N: Not Assembled

Revision history

Page or Item	Subjects (major changes since previous revision)
Revision 1.0, 2015-11-20	Initial Version
Revision 1.1, 2016-02-11	Figure 7 has been updated: X2.16 has been changed from P6.1 to P6.4; X2.15 has been changed from P5.3 to P6.3; X1.14 has been changed from P3.9 to P3.0
Revision 1.2 2016-06-15	EtherCAT [®] added to “Other Trademarks”
Revision 1.3 2022-06-10	The XMC [™] EtherCAT [®] Phy Board has been redesigned due to replacement of the BCM5241XA1KMLG PHY through the DP83848VYB/NOPBVXH48A-M PHY The redesigned PCB has got a new marking: XMC [™] EtherCAT PHY Board-V3
Revision 1.4 2022-06-20	The XMC [™] EtherCAT [®] Phy Board has been redesigned due to replacement of the BCM5241XA1KMLG PHY through the ADIN1200 PHY The redesigned PCB has got a new marking: XMC [™] EtherCAT PHY Board-V2.1