

Two-Channel Flash LED Driver with Independent Current Control

Features

- High efficiency synchronous boost converter with 2MHz/4MHz switching frequency option
- I²C interface programming and hardware STROBE/TORCH control
- Two-channel independent current sources
 - ▶ LED1/LED2: Up to 1.5A
 - ▶ Flash/Torch/IR modes
 - ▶ Independent LED on/off and current settings
 - ▶ Programmable ramp shape and time control
 - ▶ Three input low voltage protection modes
 - ▶ Torch currents up to 187.5mA (KTD2688) or 375mA (KTD2688A)
 - ▶ Flash time-out protection up to 1.60s(KTD2688A)
 - ▶ LED cathode ground connection for improved thermal dissipation
- LED open/short protection
- I²C fault read back
- RoHS and Green Compliant

Brief Description

KTD2688 is the ideal power solution for high-power flash LEDs. It includes a highly integrated synchronous boost converter and two current sources, providing a very small total solution in portable application. It has both I²C interface and hardware STROBE/TORCH pins for maximum control flexibility. The two integrated current sources are independently controlled, their on/off conditions and current settings in Flash/Torch/IR modes can be programmed independently by the I²C interface. It also has three selectable input low voltage protection modes to prevent a system reset under low battery condition.

Various protection features are integrated into KTD2688, including cycle-by-cycle input current limit protection, output overvoltage protection, LED fault (open or short) protection, flash timeout protection and thermal shutdown protection.

KTD2688 is available in a RoHS and Green compliant 12-ball 1.30mm x 1.57mm WLCSP package with 0.4mm pitch.

Applications

- Smartphones and Tablets Camera Flash
- Digital Cameras

Typical Application

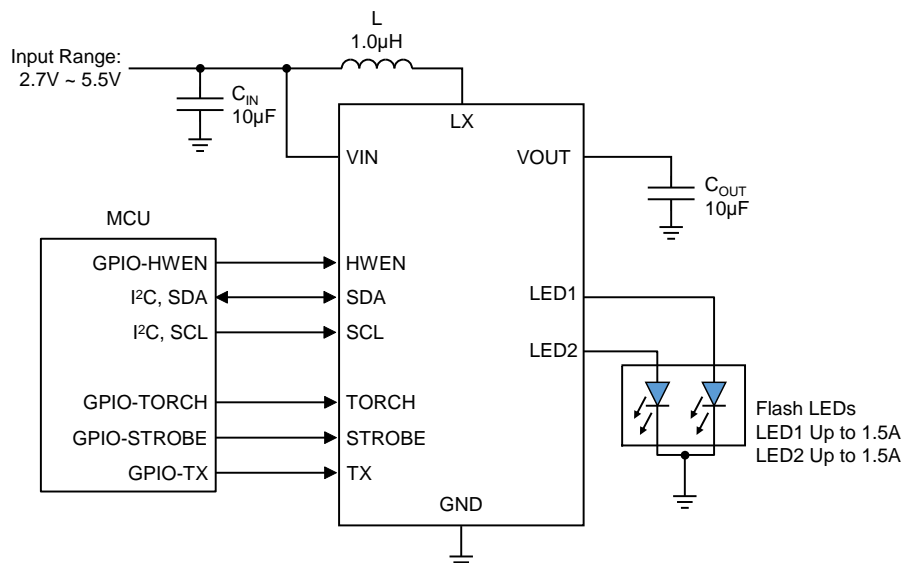

Pin Descriptions

Pin #	Name	Function
A1	GND	Ground pin
A2	VIN	Input supply pin for the device. Connect a 10µF ceramic capacitor to GND.
A3	SDA	Bi-direction data pin of the I ² C interface.
B1	LX	Switching pin of the boost converter.
B2	STROBE	Active high FLASH/IR enable pin. There is an internal 300kΩ pull-down resistor at this pin to GND.
B3	SCL	Clock input pin of the I ² C interface.
C1	VOUT	Output pin of the boost converter. Connect a 10µF ceramic capacitor to GND
C2	HWEN	Active high hardware enable pin. There is an internal 300kΩ pull-down resistor at this pin to GND.
C3	TORCH	Active high TORCH enable pin. There is an internal 300kΩ pull-down resistor at this pin to GND.
D1	LED2	Regulated output current source #2, up to 1.5A.
D2	TX	Active high power amplifier synchronization input pin.
D3	LED1	Regulated output current source #1, up to 1.5A.

WLSCP-12

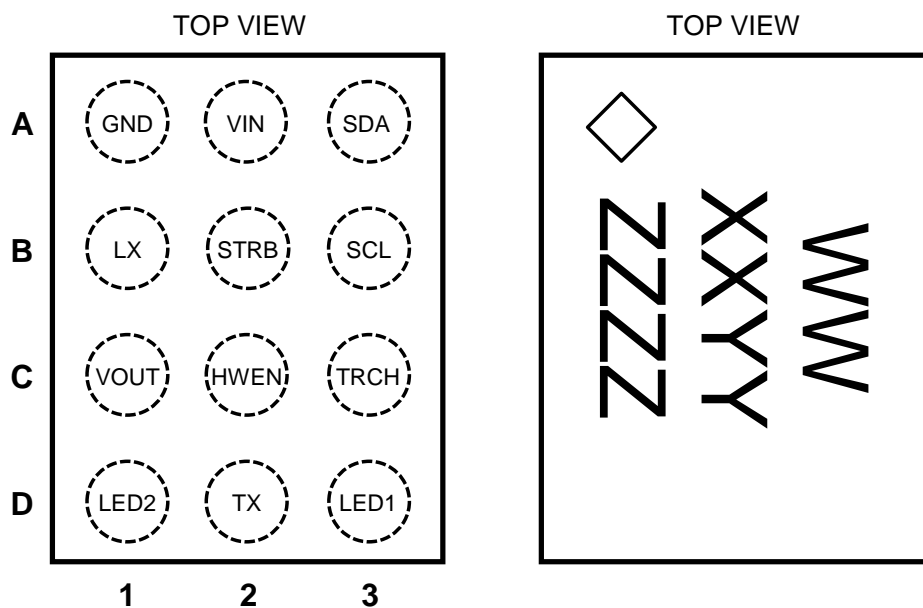

12-Bump 1.30mm x 1.57mm WLCSP Package

Top Mark
 WW = Device ID Code,
 XX = Date Code, YY = Assembly Code,
 ZZZZ = Serial Number

Absolute Maximum Ratings¹

(T_A = 25°C unless otherwise noted)

Symbol	Description	Value	Units
VIN, VOUT	Input and output voltage pins	-0.3 to 6	V
LED1, LED2	Current source pins	-0.3 to VOUT+0.3	V
SCL, SDA, STROBE, TX, TORCH, HWEN	Control pins	-0.3 to VIN+0.3	V
LX	Switching pin	-0.3 to 6.5	V
T _J	Operating Temperature Range	-40 to 150	°C
T _S	Storage Temperature Range	-65 to 150	°C
T _{LEAD}	Maximum Soldering Temperature (at leads, 10 sec)	300	°C
ESD	HBM electrical static discharge	2.0	kV

Thermal Capabilities

Symbol	Description	Value	Units
θ _{JA}	Thermal Resistance – Junction to Ambient ²	90	°C/W
P _D	Maximum Power Dissipation at T _A ≤ 25°C	Internally Limited ³	W
ΔP _D /ΔT	Derating Factor Above T _A = 25°C	-11	mW/°C

Recommended Operating Range

Description	Value
VIN, VOUT, LED1, LED2	2.7V to 5.5V
LX	≤ 6V

Ordering Information

Part Number ⁴	Marking	Operating Temperature	Package	Maximum Torch Current per Channel	Flash Time-Out
<i>KTD2688EUR-TR</i>	JXXXYYZZZ ⁵	-40°C to +85°C	WLCSP-12	187.5mA	10ms to 400ms
<i>KTD2688AEUR-TR</i>	JYXXYYZZZ ⁵	-40°C to +85°C	WLCSP-12	375mA	40ms to 1600ms

- Stresses above those listed in Absolute Maximum Ratings may cause permanent damage to the device. Functional operation at conditions other than the operating conditions specified is not implied. Only one Absolute Maximum rating should be applied at any one time.
- Junction to Ambient thermal resistance is highly dependent on PCB layout. Values are based on thermal properties of the device when soldered to an EV board.
- Internal shutdown circuitry protects the device from permanent damage. Thermal shutdown activated at typically T_J = 150°C and re-engages at typically 130°C.
- For part numbers in *Italic*, please contact your local sales representative for availability.
- XX = Date Code, YY = Assembly Code, ZZZZ = Serial Number.

Electrical Characteristics⁶

Unless otherwise noted, the *Min* and *Max* specs are applied over the full operation temperature range of -40°C to +85°C, while *Typ* values are specified at room temperature (25°C), $V_{IN} = 3.6V$, $V_{OUT} = 4V$.

Symbol	Description	Conditions	Min	Typ	Max	Units	
VIN Supply							
V_{IN}	Input operating range		2.7		5.5	V	
I_Q	IC operating current	Not switching, pass mode		0.61		mA	
I_{SHDN}	V_{IN} pin shutdown current	Shutdown mode, HWEN = GND			1	μA	
I_{SB}	V_{IN} pin standby current	Standby, HWEN = V_{IN}		2.5		μA	
UVLO	Input under voltage lockout	V_{IN} Rising		2.5		V	
UVLO _{HYST}	UVLO hysteresis			0.15		V	
Boost Converter							
I_{LIM}	Peak NMOS current limit	Reg 0x07, bit[0] = '0'		1.9		A	
		Reg 0x07, bit[0] = '1'		2.8		A	
F_{SW}	Oscillator frequency	Reg 0x07, bit[1] = '0'		2		MHz	
		Reg 0x07, bit[1] = '1'		4		MHz	
D_{MAX}	Maximum duty cycle	$F_{SW} = 2MHz$		88		%	
V_{OVP}	Internal OV threshold of V_{OUT}	V_{OUT} Rising		5		V	
V_{LVP}	V_{IN} low voltage protection threshold	Reg 0x02, bit[5:3] = '000', $T_A = 25^\circ C$		2.9		V	
Current Sources							
I_D	Output Current Accuracy	LED1,2 = 1500mA setting, Flash mode	$T_A = 25^\circ C$	-5%	1500	+5%	mA
		LED1,2 = 93.75mA setting, Torch mode		-8%	93.75	+8%	mA
	Output Current Accuracy	LED1,2 = 187.5mA setting, Torch mode		-8%	187.5	+8%	mA
$T_{TIMEOUT}$	Flash Timeout Period	Reg 0x08, bit[3:0] = '1010'		150		ms	
$T_{TIMEOUT}$	Flash Timeout Period (KTD2688A)	Reg 0x08, bit[3:0] = '1010'		600		ms	
I²C-Compatible Voltage Specifications (SCL, SDA)							
V_{IL}	Input Logic Low Threshold				0.4	V	
V_{IH}	Input Logic High Threshold		1.4			V	
V_{OL}	SDA Output Logic Low	$I_{SDA} = 3mA$			0.4	V	
I²C-Compatible Timing Specifications (SCL, SDA), see Figure 1							
t_1	SCL (Clock Period)		2.5			μs	
t_2	Data In Setup Time to SCL High		100			ns	
t_3	Data Out Stable After SCL Low		0			ns	
t_4	SDA low setup time to SCL low (Start)		100			ns	
t_5	SDA high hold time after SCL high (Stop)		100			ns	
Control – HWEN, TORCH, STROBE, TX							
V_{TH-L}	Input Logic Low Threshold				0.4	V	
V_{TH-H}	Input Logic High Threshold		1.4			V	
$R_{Pull-down}$	Internal pull down resistors			300		k Ω	
Thermal Shutdown							
T_{J-TH}	Thermal shutdown threshold			150		$^\circ C$	
	Thermal shutdown hysteresis			20		$^\circ C$	

6. KTD2688 is guaranteed to meet performance specifications over the -40°C to +85°C operating temperature range by design, characterization and correlation with statistical process controls.

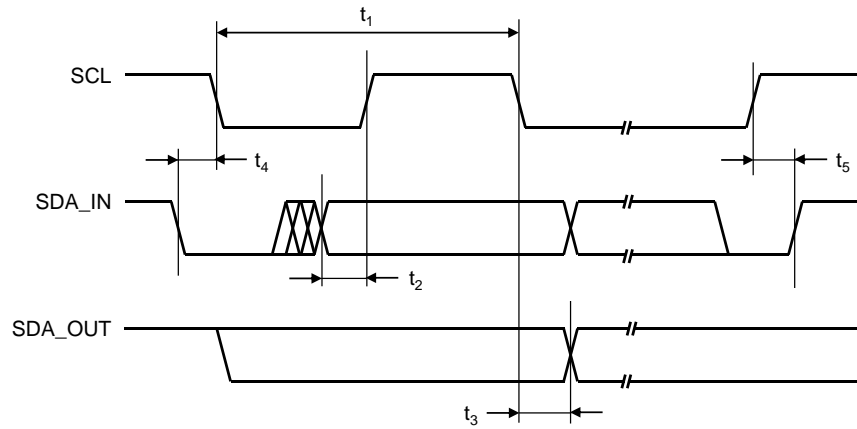
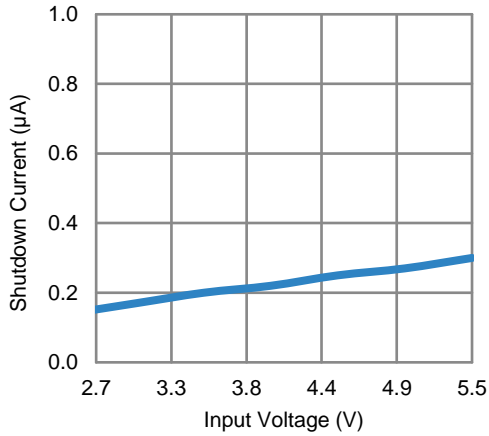

Figure 1. I²C Compatible Interface Timing

Typical Characteristics

$V_{IN} = 3.6V$, $L = 1.0\mu H$, $C_{IN} = 10\mu F$, $C_{OUT} = 10\mu F$, Temp = 25°C unless otherwise specified.

Shutdown Current vs. VIN
($H_{WEN} = 0V$, $I^2C = 0$)



Quiescent Current vs. VIN
(non-switching)

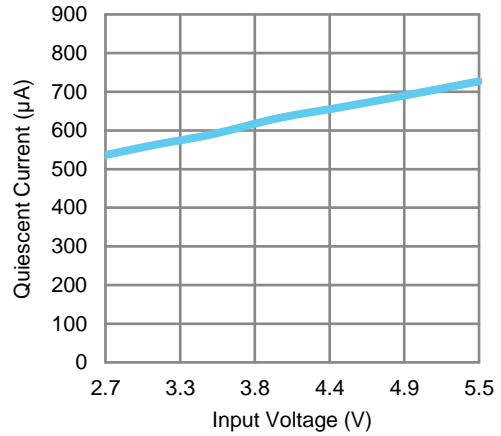

Switching Frequency vs. VIN
(2MHz)

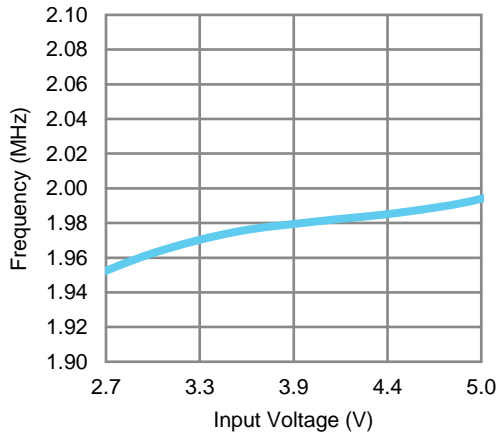

Switching Frequency vs. VIN
(4MHz)

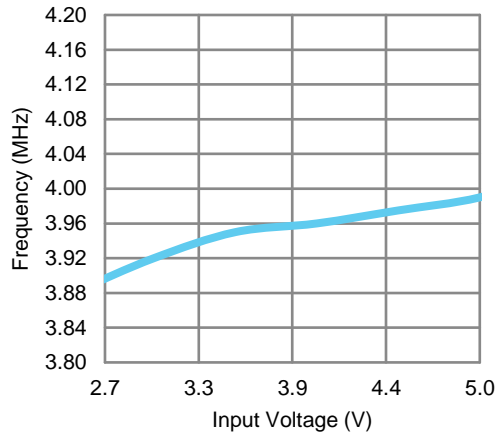

Input Logic Threshold vs. VIN

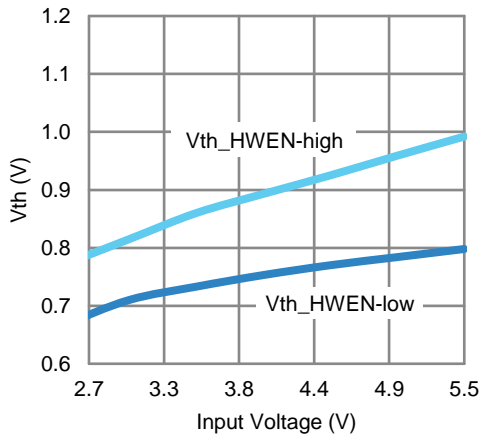

Typical Characteristics

$V_{IN} = 3.6V$, $L = 1.0\mu H$, $C_{IN} = 10\mu F$, $C_{OUT} = 10\mu F$, Temp = 25°C unless otherwise specified.

LED Current vs. VIN
(Flash, LED1 on, LED2 off, 2MHz)

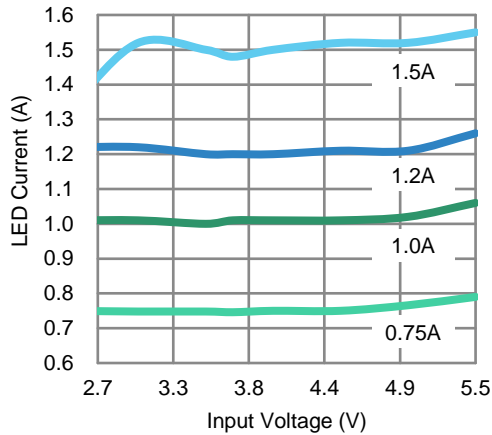

LED Current vs. VIN
(Torch, 2MHz)

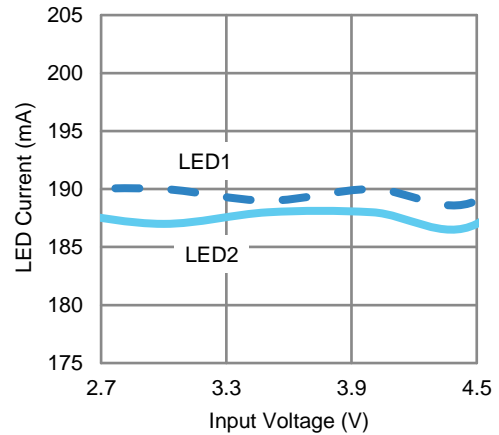

LED Efficiency vs. VIN
(Torch Mode)

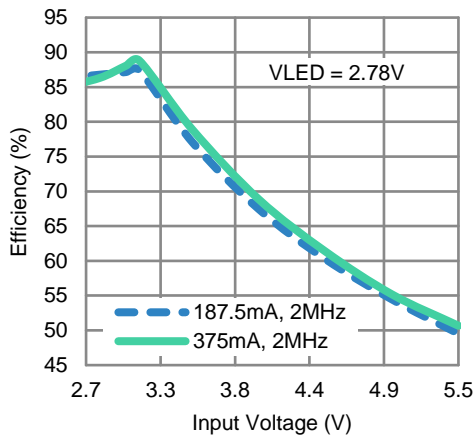

LED Efficiency vs. VIN
(Flash Mode, 1A)

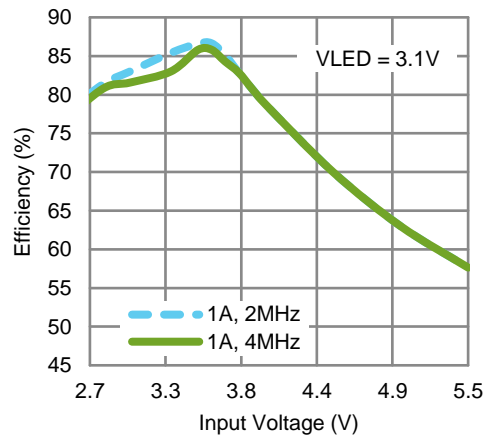

LED Efficiency vs. VIN
(Flash Mode, 1.5A)

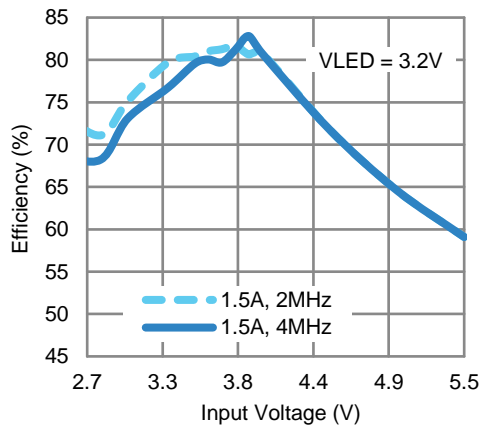

Typical Characteristics

$V_{IN} = 3.6V$, $L = 1.0\mu H$, $C_{IN} = 10\mu F$, $C_{OUT} = 10\mu F$, Temp = 25°C unless otherwise specified.

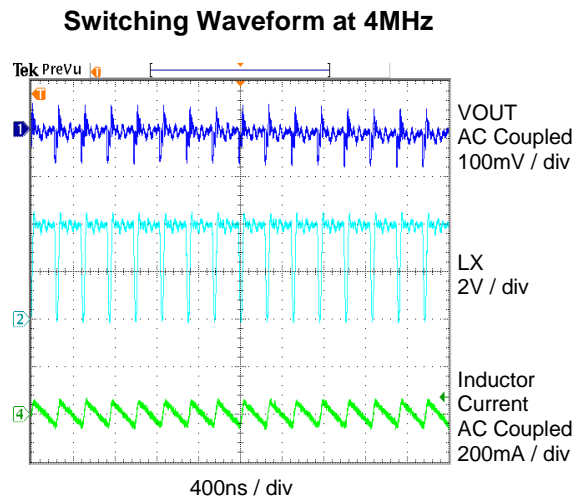
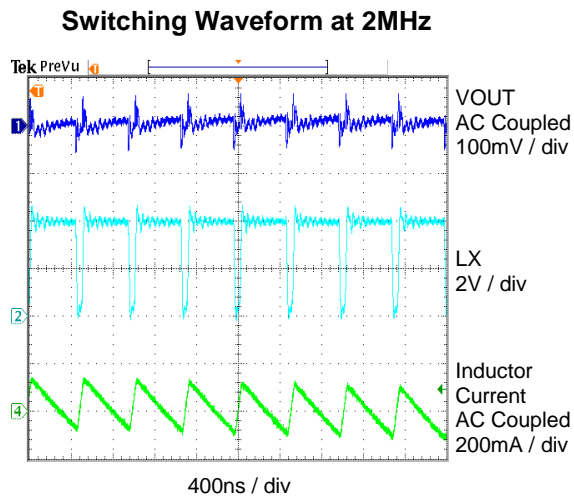
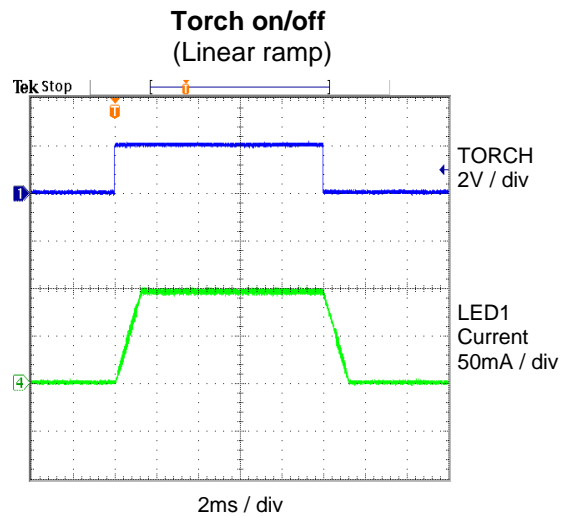
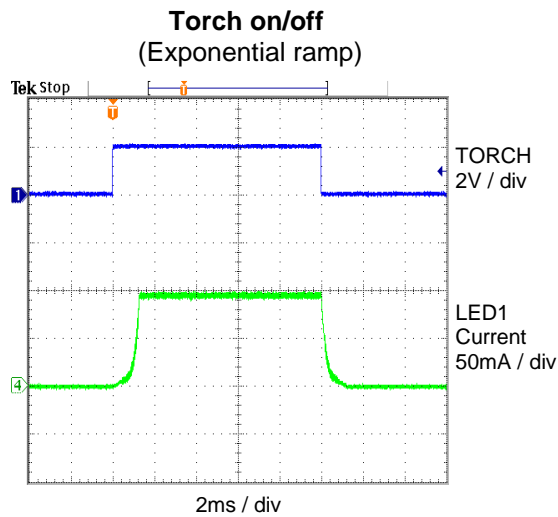
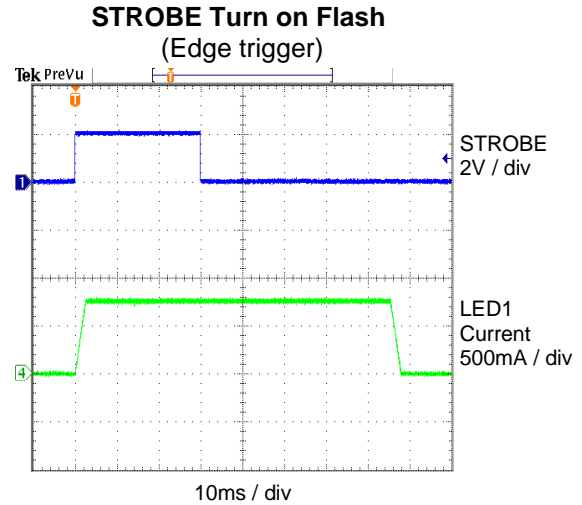
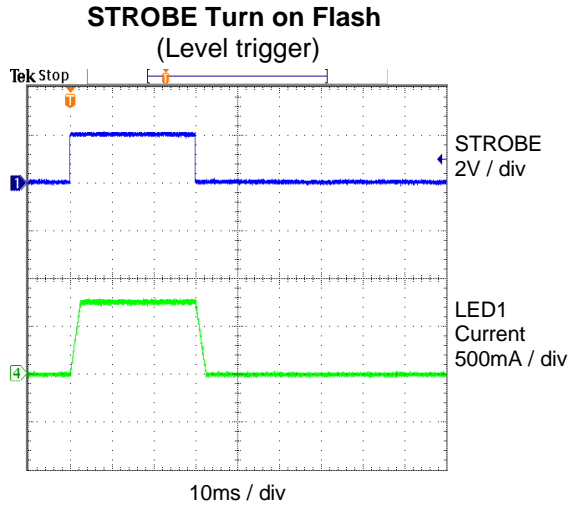

Typical Characteristics

$V_{IN} = 3.6V$, $L = 1.0\mu H$, $C_{IN} = 10\mu F$, $C_{OUT} = 10\mu F$, $Temp = 25^{\circ}C$ unless otherwise specified.

Low Voltage Protection

(Stop & Hold Mode with LVP hysteresis = 0mV)

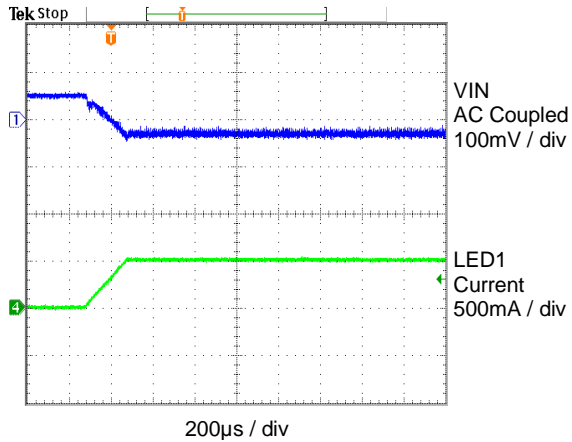

Low Voltage Protection

(Down Mode with LVP hysteresis = 0mV)

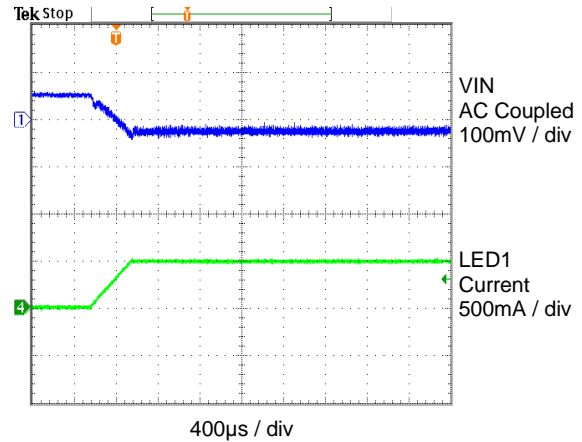

Low Voltage Protection

(Up & Down Mode with LVP hysteresis = 0mV)

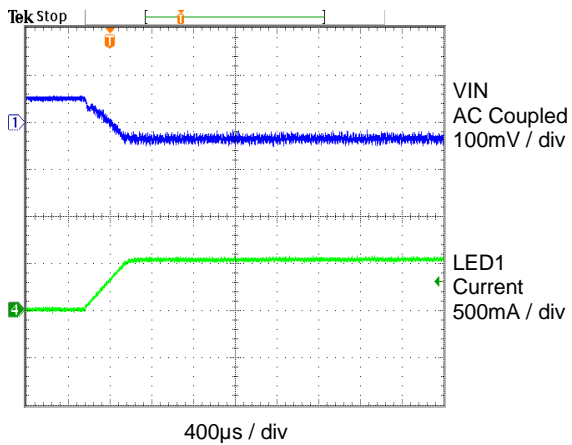

TX Mode

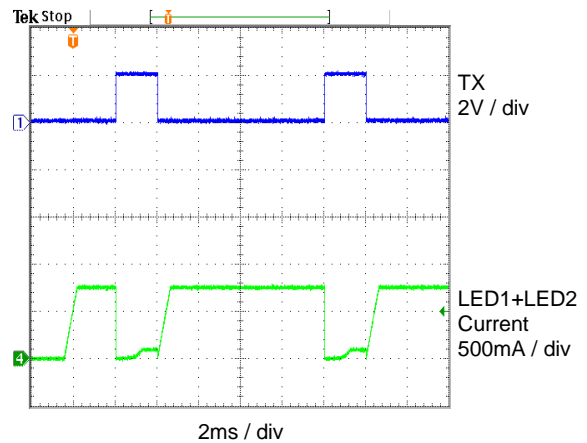

IR Mode

(Pass Mode Setting)

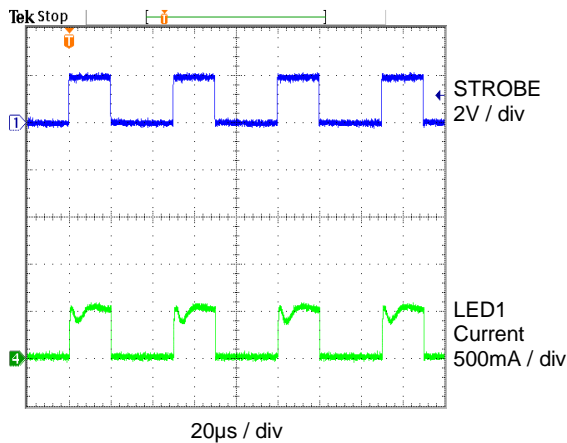

Functional Block Diagram

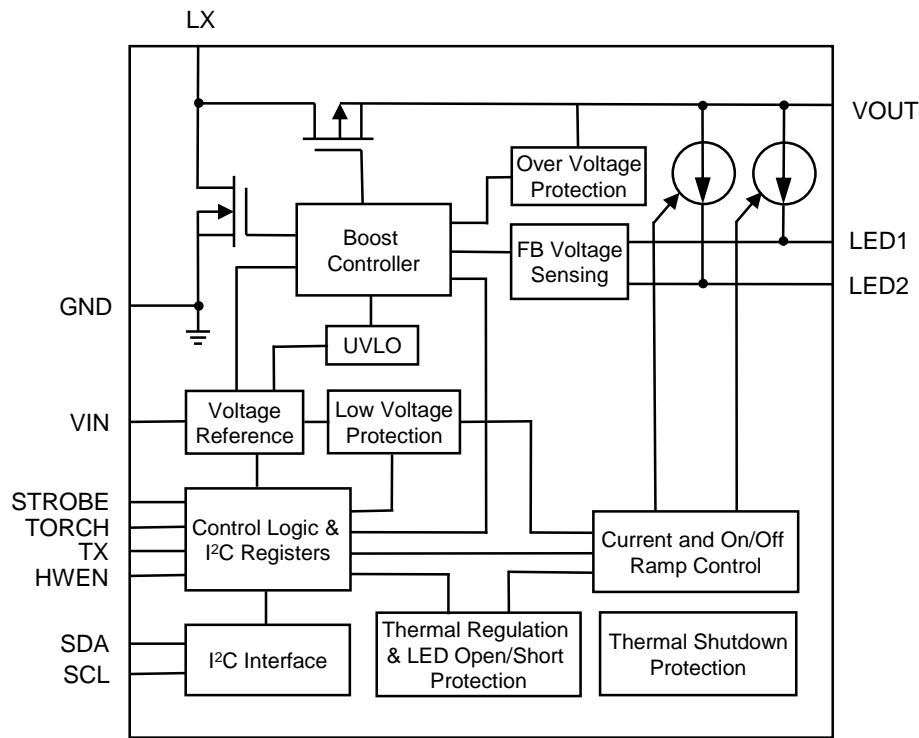

Functional Description

KTD2688 is a high-power flash LED driver capable of delivering up to 1.5A for both LED1 and LED2. It consists of a high switching frequency synchronous boost converter and two independently controlled current sources in a small WLCSP package size. The inductor-based boost converter integrates two low $R_{DS(on)}$ power MOSFETs, and operates at a switching frequency of 2.0MHz (default) or 4MHz to minimize the size of the external inductor and capacitors. Unlike a traditional DC-DC boost converter with a fixed output voltage, KTD2688 dynamically adjusts the output voltage depending on the flash LED forward voltage and current, it only boosts the output to a voltage sufficient to drive the LEDs at the programmed output current. The use of unique control scheme maintains accurate current regulation in the current sources while minimizing the output voltage, increasing the overall conversion efficiency.

The control interface is designed for maximum flexibility and compatibility with various types of system controls. KTD2688 is mainly programmed and controlled via an I²C-compatible interface, but also includes three logic inputs that can provide a hardware flash enable (STROBE) and a hardware torch enable (TORCH), as well as a flash interrupt (TX), which can be used to reduce the flash current during power amplifier pulse event to lower the battery load current. The I²C control features include the independent on/off and current control of the two current sources in Flash/Torch/IR modes, the on/off ramp timing and current shape control, three input low voltage protection modes, flash safety time-out protection, boost converter current limit and switching frequency options, and various fault events read back. In addition, KTD2688 also has various protection features including LED open and short protections

Hardware Enable & Standby Mode

KTD2688 has a logic input HWEN pin to enable/disable the device. When HWEN is set low, the device goes into shutdown mode, all I²C registers are reset to default, and the I²C interface is disabled. Under this condition,

the device does not respond to any I²C command. When HWEN is set high, the device goes into standby mode, the I²C interface is enabled, and the device can respond to I²C command.

There are two kinds of power-up sequences, shown in Figure 2 and Figure 3.

- If HWEN is tied to VIN, once VIN goes above around 2.0V, HWEN should stay high for at least $t_{wait} = 150\mu s$ time before any I²C command can be accepted.
- If HWEN is driven by a GPIO, once HWEN goes from low to high, HWEN should stay high for at least $t_{wait} = 150\mu s$ time before receiving any I²C command.

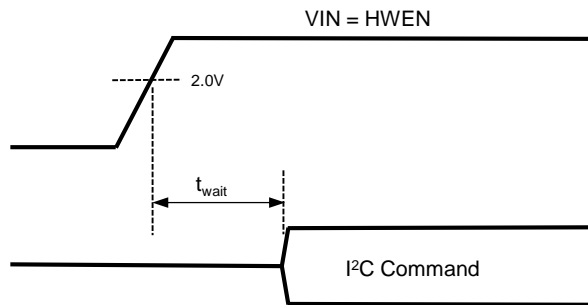

Figure 2. Power Up Sequence with HWEN Tied to VIN

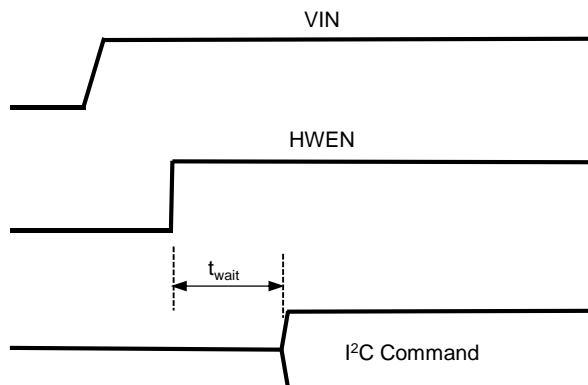

Figure 3. Power Up Sequence with HWEN Driven by GPIO

User can use either HWEN or I²C command to turn off the part, but there are some differences.

- If setting HWEN input low to turn off the part, the LED current will be turned off immediately without any ramp down control. After shutdown, the bias current for the device is much less than $1\mu A$, and the I²C interface is disabled.
- If using an I²C command to turn off the part while keeping HWEN high, the LED current will have ramp down control. After the LED current ramp down is finished, the VIN pin current is about $2.5\mu A$ typical to keep the I²C interface alive.

Flash Mode

In Flash mode, LED1 and LED2 current can be programmed up to 1.5A. The flash current values are controlled by I²C registers 0x03 and 0x04. LED2 current code in I²C register 0x04 has the option to be overridden by LED1 current code in I²C register 0x03. The flash on/off ramp time (ranging from $512\mu s$ to 64ms) is controlled by I²C register 0x07 bits[6:4], the shape of the ramp is always linear. The flash mode can be activated either by I²C register 0x01 bits[3:2] or by STROBE pin rising edge when STROBE pin is enabled, and it can be deactivated by I²C register 0x01 bits[3:2], or by STROBE pin, or by flash time-out event. After the flash time-out event, I²C register 0x01 bits[3:2] will be reset to standby mode.

If using STROBE pin to control the flash mode, there is an option to select when the flash mode is deactivated. If Strobe Type is selected as Level Triggered, flash mode is deactivated during STROBE pin falling edge or flash time-out event, as shown in Figure 4. If Strobe Type is selected as Edge Triggered, flash mode is only deactivated during flash time-out event, STROBE pin falling edge cannot deactivate it, as shown in Figure 5.

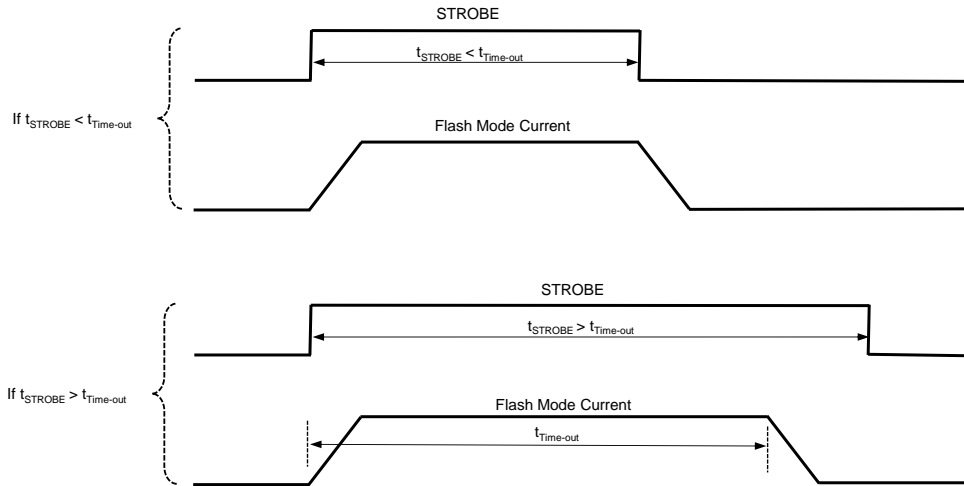

Figure 4. Flash Mode Current Controlled by STROBE (Level Triggered)

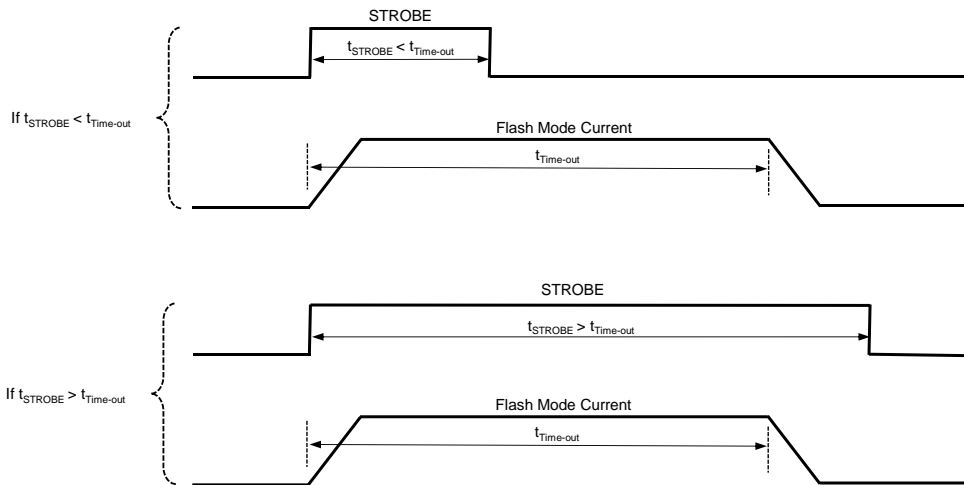

Figure 5. Flash Mode Current Controlled by STROBE (Edge Triggered)

Torch Mode

In Torch mode, LED1 and LED2 current can be programmed up to 187.5mA (KTD2688) or 375mA (KTD2688A). The torch current values are controlled by I²C registers 0x05 and 0x06. LED2 current code in I²C register 0x06 has the option to be overridden by LED1 current code in I²C register 0x05. The torch on/off ramp time (ranging from 0 to 1024ms) is controlled by I²C register 0x08 bits [6:4], the shape of the ramp (exponential or linear) is controlled by I²C register 0x08 bit [7]. The torch mode can be activated either by I²C register 0x01 bits[3:2] or by TORCH pin rising edge when TORCH pin is enabled, and it can be deactivated by I²C register 0x01 bits[3:2], or by TORCH pin falling edge.

IR Mode

In IR mode, the current setting is similar to Flash mode setting, which is controlled by I²C registers 0x03 and 0x04. LED2 current code in I²C register 0x04 has the option to be overridden by LED1 current code in I²C register 0x03. For IR mode, I²C register 0x01 bits[3:2] should be to '01' and STROBE pin should be enabled, then STROBE pin rising edge can activate IR mode, and STROBE pin falling edge or flash time-out event can

deactivate IR mode. In IR mode, the two current sources are enabled to the full current setting with no delay or slow ramp during STROBE rising edge, and they are fully turned off immediately with no delay or slow ramp during STROBE falling edge. This allows IR current to follow the fast frequency IR transmission of the STROBE pin signal. For IR mode, STROBE pin only allows Level Triggered, and doesn't allow Edge Triggered, but it is still protected by flash time-out if STROBE width is too long. In IR mode, since the STROBE width can be very short, the boost converter might not have enough time to boost the output high enough to regulate the current sources, it is recommended to set the boost converter to Pass mode and let the output voltage be equal to the input voltage.

Table 1 summarizes the control of Shutdown/Standby/Flash/Torch/IR modes.

Table 1. Mode Control Table

HWEN	I ² C register 0x01 bits[3:2]	STROBE Enable	TORCH Enable	STROBE Pin	TORCH Pin	FUNCTION
0	XX	X	X	X	X	Shutdown, I ² C Disabled
1	00	0	0	X	X	Standby, I ² C Enabled
1	00	0	1	X	Positive Edge	External Torch Mode
1	00	1	0	Positive Edge	X	External Flash Mode
1	00	1	1	0	Positive Edge	External Torch Mode
1	00	1	1	Positive Edge	0	External Flash Mode
1	00	1	1	Positive Edge	Positive Edge	External Flash Mode
1	10	X	X	X	X	Internal Torch Mode
1	11	X	X	X	X	Internal Flash Mode
1	01	0	X	X	X	IR Standby Mode
1	01	1	X	0	X	IR Standby Mode
1	01	1	X	Positive Edge	X	IR Mode

Power Amplifier Synchronization (TX)

TX input is to reduce flash mode LED current during the power amplifier transmit event to limit the total battery current. When the device is working in flash mode and TX pin is pulled high, it will force the device from flash mode to torch mode with the programmed torch mode current setting. After the power amplifier transmit event and TX comes back to low, if the flash time-out event hasn't finished, the device goes back to flash mode with the programmed flash mode current setting. The device continues to work until the flash time-out event. TX event writes a '1' to the I²C register 0x0A bit[7], this fault flag will be reset to '0' once I²C register 0x0A is read back through I²C interface, or by VIN power on reset, or by HWEN reset, or by I²C software reset.

VIN Low Voltage Protection (LVP)

In flash mode, the high LED current might pull the input battery voltage low. KTD2688 has three VIN Low Voltage Protection (LVP) modes to adjust the LED current based on the input voltage to prevent the battery voltage from going too low and trigger a system reset. The adjustable LVP threshold has 8 steps, ranging from 2.9V to 3.6V with 0.1V step. The three modes are "Stop & Hold", Down and "Up & Down" modes, shown in Figure 6. These LVP modes only work in flash mode.

- In Stop & Hold mode, during the flash current turn on ramp, if VIN drops below the LVP threshold, after 4μs deglitch delay, the LED current stops rising and remains at the last value. After that, even if VIN changes, the LED current setting will not change during the remaining of the flash event.
- In Down mode, during the flash current turn on ramp, when VIN drops below the LVP threshold, after 4μs deglitch delay, the LED current stops rising and starts to decrease until VIN goes back to be above the LVP threshold (or plus a hysteresis). After that, if VIN increases during the remaining flash event, the LED current setting will not change. But if VIN drops below LVP threshold again, the LED current is decreased accordingly.

- In Up & Down mode, during the flash current turn on ramp, when VIN drops below the LVP threshold, after 4μs deglitch delay, the LED current stops rising and starts to decrease until VIN goes back to be above the LVP threshold (or plus a hysteresis). Then, the LED current starts to increase until VIN drops below the LVP threshold again after the deglitch time. The flash current is repeatedly increased and decreased during the entire flash event to keep VIN close to the LVP threshold.

LVP event writes a '1' into the I²C register 0x0B bit[2], this fault flag bit resets to '0' once the register is read via I²C interface, or by VIN power on reset, or by HWEN reset, or by I²C software reset.

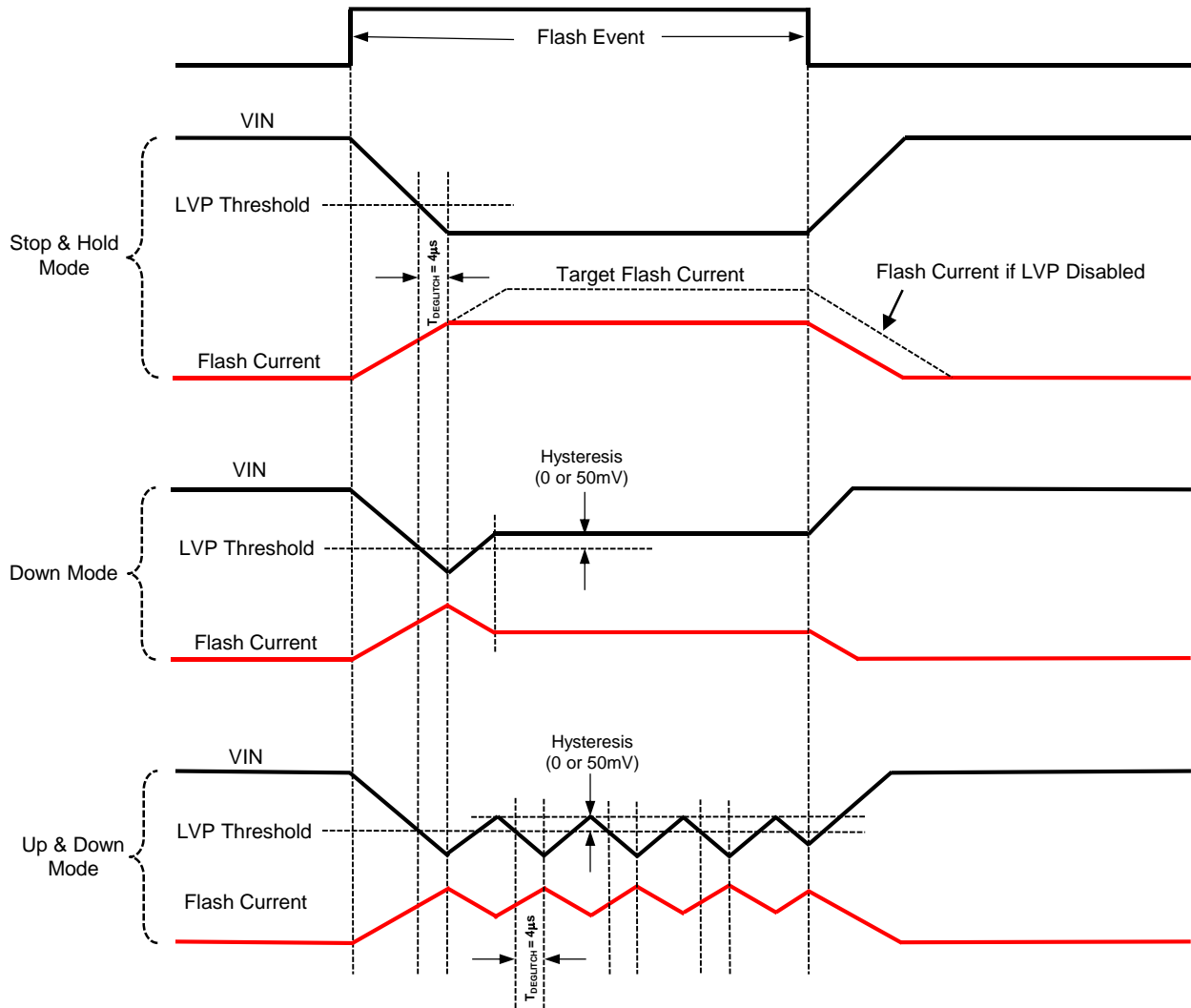

Figure 6. LVP Modes

Flash Time-out

The Flash time-out function sets the maximum time of one flash event, whether a flash stop command is received or not. The device has 16 flash time-out settings controlled by I²C register 0x08 bits [3:0], ranging from 10ms to 400ms for KTD2688 or 40ms to 1600ms for KTD2688A. Flash time-out feature applies to both flash and IR modes, and it continues to count when the flash mode is switched to torch mode during TX high event. Flash time-out event writes a '1' to the I²C register 0x0A bit[0], this fault flag is reset to '0' when it is read through I²C interface, or by VIN power on reset, or by HWEN reset, or by I²C software reset.

UVLO

The device has under voltage lock-out (UVLO) function to monitor the input voltage. Once the input voltage VIN drops below UVLO falling threshold (around 2.35V), the output current is disabled and the boost converter stops switching. Once the input voltage increases above UVLO rising threshold (around 2.5V), the output current resumes its previous setting. UVLO event writes a '1' to the I²C register 0x0A bit[1], this fault flag is reset to '0' once I²C register 0x0A is read through I²C interface, or by VIN power on reset, or by HWEN reset, or by I²C software reset. Even it is not read back, the device resumes normal operation once the input voltage comes back above UVLO rising threshold.

Thermal Shutdown

In flash or IR mode, the device has thermal shutdown protection, when the IC temperature goes above thermal shutdown rising threshold (around 150°C), the output current is disabled and the boost converter stops switching. Once the IC temperature drops below thermal shutdown falling threshold (around 130°C), the output current resumes to its previous setting. Thermal shutdown writes a '1' to the I²C register 0x0A bit[2], this fault flag is reset to '0' once I²C register 0x0A is read back through I²C interface, or by VIN power-on-reset, or by HWEN reset, or by I²C software reset. Even if the register is not read back, the device resumes normal operation once the IC temperature goes below thermal shutdown falling threshold.

Current Limit

The boost converter has cycle-by-cycle current limit protection for its power NMOS when it is switching. Once the current limit is reached, the power NMOS turns off until the next switching cycle. The device has two current limit settings (2.8A and 1.9A) controlled by I²C register 0x07 bit[0]. Current limit event writes a '1' to the I²C register 0x0A bit[3], this fault flag is reset to '0' once I²C register 0x0A is read back through I²C interface, or by VIN power-on-reset, or by HWEN reset, or by I²C software reset. The current limit function is disabled when the device is working in Pass mode because it doesn't sense power NMOS current.

LED Short Protection

LED short protection can be enabled or disabled by I²C register 0x07 bit[3]. When LED short protection is enabled, after turn-on ramp of the output current, the device senses LED1 and LED2 pin voltages. If the LED pin voltage drops below around 0.5V, after about 256μs deglitch time, the corresponding LED channel is disabled, the un-shortened channel still works. LED short condition writes a '1' to the I²C register 0x0A bit[5] or bit[4], this fault flag is reset to '0' once I²C register 0x0A is read back, or by VIN power-on-reset, or by HWEN reset, or by I²C software reset. Once the LED short condition is removed, the associated channel can resume normal operation by toggling the mode setting, or by disabling and then re-enabling that channel.

LED Open Protection and Overvoltage Protection (OVP)

If Boost mode is enabled while an LED is open during normal operation, the output voltage goes up to the overvoltage protection (OVP) threshold (around 5V), then the device senses LED1/LED2 voltages to automatically detect which LED channel is open and disables the open channel; then the output voltage goes back and the other normal LED channel still works. OVP event writes a '1' to the I²C register 0x0B bit[1], this fault flag is reset to '0' once I²C register 0x0B is read back, or by VIN power-on-reset, or by HWEN reset, or by I²C software reset. Once the LED open condition is removed, that channel can resume normal operation by toggling the mode setting.

Software Reset

The device has a software reset function controlled by I²C register 0x07 bit[7]. Writing a '1' to this bit resets all I²C registers to their default settings and reset all fault flags; this bit will also be reset to '0' automatically.

Application Information

I²C Serial Data Bus

KTD2688 supports the I²C bus protocol. A device that sends data onto the bus is defined as a transmitter and a device receiving data as a receiver. The device that controls the bus is called a master, whereas the devices controlled by the master are known as slaves. A master device must generate the serial clock (SCL), control bus access and generate START and STOP conditions to control the bus. KTD2688 operates as a slave on the I²C bus. Within the bus specifications a standard mode (100kHz maximum clock rate) and a fast mode (400kHz maximum clock rate) are defined. KTD2688 works in both modes. Connections to the bus are made through the open-drain I/O lines SDA and SCL.

The following bus protocol has been defined in Figure 7:

- Data transfer may be initiated only when the bus is not busy.
- During data transfer, the data line must remain stable whenever the clock line is HIGH. Changes in the data line while the clock line is high are interpreted as control signals.

Accordingly, the following bus conditions have been defined:

Bus Not Busy

Both data and clock lines remain HIGH.

Start Data Transfer

A change in the state of the data line, from HIGH to LOW, while the clock is HIGH, defines a START condition.

Stop Data Transfer

A change in the state of the data line, from LOW to HIGH, while the clock line is HIGH, defines the STOP condition.

Data Valid

The state of the data line represents valid data when, after a START condition, the data line is stable for the duration of the HIGH period of the clock signal. The data on the line must be changed during the LOW period of the clock signal. There is one clock pulse per bit of data.

Each data transfer is initiated with a START condition and terminated with a STOP condition. The number of data bytes transferred between START and STOP conditions are not limited, and are determined by the master device. The information is transferred byte-wise and each receiver acknowledges with a ninth bit.

Acknowledge

Each receiving device, when addressed, is obliged to generate an acknowledge after the reception of each byte. The master device must generate an extra clock pulse that is associated with this acknowledge bit.

A device that acknowledges must pull down the SDA line during the acknowledge clock pulse in such a way that the SDA line is stable LOW during the HIGH period of the acknowledge-related clock pulse. Setup and hold times must also be taken into account.

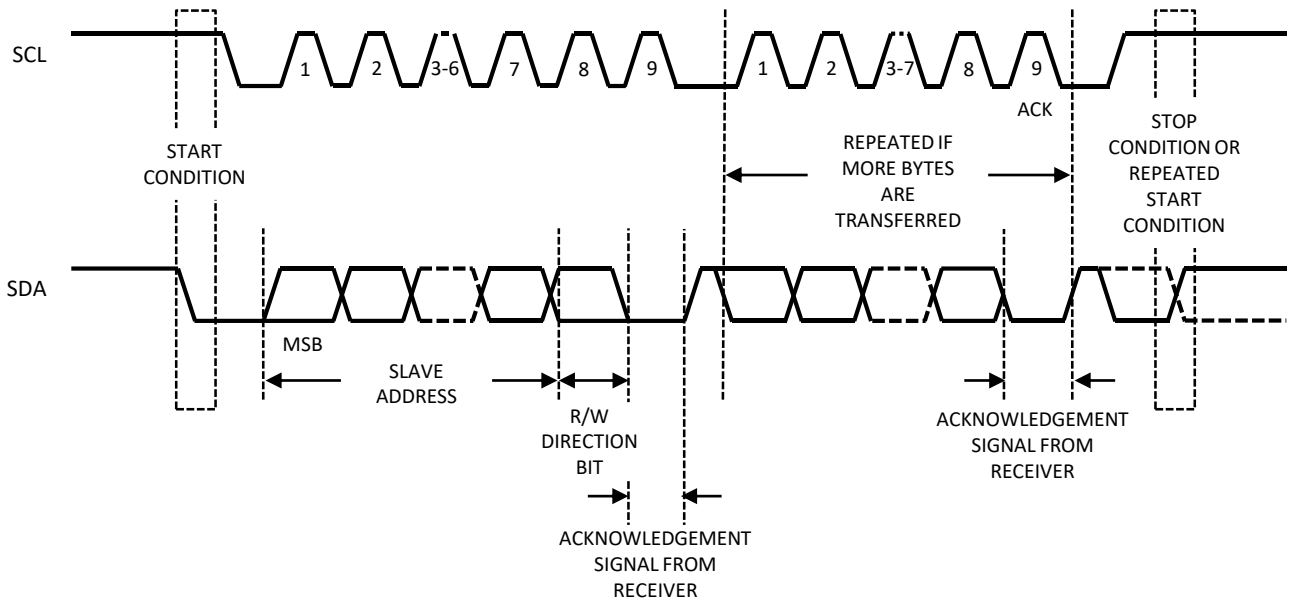

Figure 7. Data Transfer on I²C Serial Bus

KTD2688 7-bit slave device address is 1100011 binary (or 0x63h).

There are two kinds of I²C data transfer cycles: write cycle and read cycle.

I²C Write Cycle

For I²C write cycle, data is transferred from a master to a slave. The first byte transmitted is the 7-bit slave address plus one bit of '0' for write. Next follows a number of data bytes. The slave returns an acknowledge bit after each received byte. Data is transferred with the most significant bit (MSB) first. Figure 8 shows the sequence of the I²C write cycle.

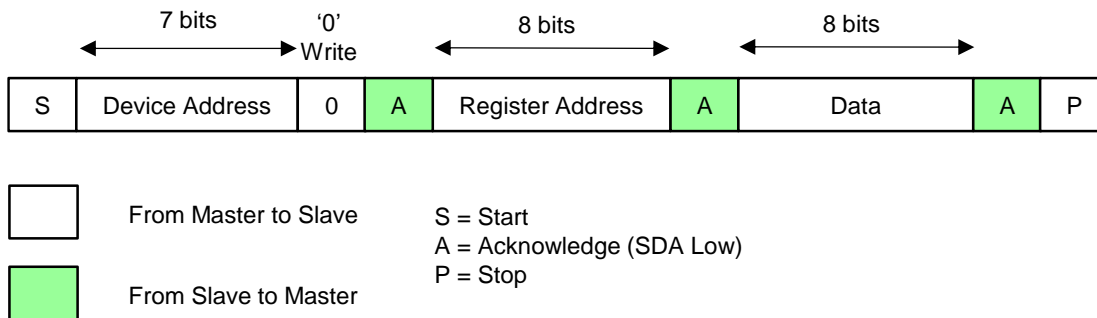

Figure 8. I²C Write Cycle

I²C Write Cycle Steps:

- Master generates start condition.
- Master sends 7-bit slave address and 1-bit data direction '0' for write.
- Slave sends acknowledge if the slave address is matched.
- Master sends 8-bit register address.
- Slave sends acknowledge.
- Master sends 8-bit data for that addressed register.
- Slave sends acknowledge.
- If master sends more data bytes, the register address will be incremented by one after each acknowledge.
- Master generate stop condition to finish the write cycle.

I²C Read Cycle

For I²C read cycle, data is transferred from a slave to a master. But to start the read cycle, master needs to write the register address first to define which register data to read. Figure 9 shows the steps of the I²C read cycle.

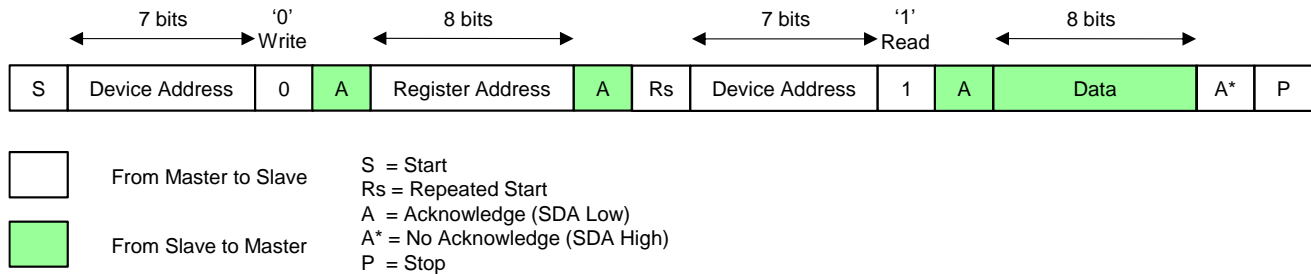

Figure 9. I²C Read Cycle

I²C Read Cycle Steps:

- Master generates start condition.
- Master sends 7-bit slave address and 1-bit data direction '0' for write.
- Slave sends acknowledge if the slave address is matched.
- Master sends 8-bit register address.
- Slave sends acknowledge.
- Master generates repeated start condition.
- Master sends 7-bit slave address and 1-bit data direction '1' for read.
- Slave sends acknowledge if the slave address is matched.
- Slave sends the data byte of that addressed register.
- If master sends acknowledge, the register address will be incremented by one after each acknowledge and the slave will continue to send the data for the updated addressed register.
- If master sends no acknowledge, the slave will stop sending the data.
- Master generate stop condition to finish the read cycle.

I²C Register Map

Table 2 summarizes the device I²C registers, their read/write access and default values. The I²C registers can be reset to their default values by VIN power-on-reset, or by HWEN reset, or by I²C software reset.

Table 2. I²C Register Map

Register Name	Address (Hex)	Read/Write	Default Value
Control Setting Register	0x01	Read/Write	0x80
LVP Setting Register	0x02	Read/Write	0x01
LED1 Flash Current Register	0x03	Read/Write	0xBF
LED2 Flash Current Register	0x04	Read/Write	0x3F
LED1 Torch Current Register	0x05	Read/Write	0xBF
LED2 Torch Current Register	0x06	Read/Write	0x3F
Boost Converter Register	0x07	Read/Write	0x09
Timing Register	0x08	Read/Write	0x1A
Fault Flag 1 Register	0x0A	Read	0x00
Fault Flag 2 Register	0x0B	Read	0x00
Device ID Register	0x0C	Read	Reserved

I²C Register Description

The following tables summarize the setting of each I²C register. Reserved bits should be written as '0' and ignored during read.

Table 3. Control Setting Register (Address 0x01, Read/Write)

Bit 7 TX Pin	Bit 6 STROBE Pin Trigger	Bit 5 STROBE Pin	Bit 4 TORCH Pin	Bits [3:2] Mode Setting	Bit 1 LED2 Channel	Bit 0 LED1 Channel
0 = Disable 1 = Enable (Default)	0 = Level (Default) 1 = Edge	0 = Disable (Default) 1 = Enable	0 = Disable (Default) 1 = Enable	00 = Standby (Default) 01 = IR Mode 10 = Torch Mode 11 = Flash Mode	0 = Disable (Default) 1 = Enable	0 = Disable (Default) 1 = Enable

Note: Adjusting STROBE Level/Edge trigger setting while turning on/off flash mode using STROBE pin is not recommended. There is no timing limit for STROBE pulse width to turn on/off the flash mode.

Table 4. LVP Setting Register (Address 0x02, Read/Write)

Bits [7:6]	Bits [5:3] LVP Voltage Threshold	Bit 2 LVP Voltage Hysteresis	Bits [1:0] LVP Modes
Reserved	000 = 2.9V (Default) 001 = 3.0V 010 = 3.1V 011 = 3.2V 100 = 3.3V 101 = 3.4V 110 = 3.5V 111 = 3.6V	0 = 0V (Default) 1 = 50mV	00 = Disable 01 = Stop & Hold (Default) 10 = Down 11 = Up & Down

Table 5. LED1 Flash Current Register (Address 0x03, Read/Write)

Bit 7 LED2 Flash Current Code Override	Bits [6:0] LED1 Flash Current Code
0 = LED2 flash current is set by I ² C register 0x04 1 = LED2 flash current equals to LED1 flash current (Default)	$I_{FLASH1} \text{ (mA)} = (\text{Code} + 1) \times 1500 / 128 \text{ (mA)}$ 0000000 = 11.72mA 0000001 = 23.44mA 0111111 = 750mA (Default) 1000000 = 761.72mA 1111111 = 1500mA

Table 6. LED2 Flash Current Register (Address 0x04, Read/Write)

Bit 7	Bits [6:0] LED2 Flash Current Code
Reserved	$I_{FLASH1} \text{ (mA)} = (\text{Code} + 1) \times 1500 / 128 \text{ (mA)}$ 0000000 = 11.72mA 0000001 = 23.44mA 0111111 = 750mA (Default) 1000000 = 761.72mA 1111111 = 1500mA

Table 7. LED1 Torch Current Register (Address 0x05, Read/Write)

Bit 7 LED2 Torch Current Code Override	Bits [6:0] LED1 Torch Current Code
0 = LED2 torch current is set by I ² C register 0x06 1 = LED2 torch current equals to LED1 torch current (Default)	$I_{TORCH1} \text{ (mA)} = (\text{Code} + 1) \times 187.5\text{mA} / 128 \text{ (KTD2688)}$ $I_{TORCH1} \text{ (mA)} = (\text{Code} + 1) \times 375\text{mA} / 128 \text{ (KTD2688A)}$ 0000000 = 1.465mA (KTD2688) or 2.93mA(KTD2688A) 0000001 = 2.93mA (KTD2688) or 5.86mA(KTD2688A) 0111111 = 93.75mA (KTD2688, Default) or 187.5mA (KTD2688A, Default) 1000000 = 95.215mA (KTD2688) or 190.43mA(KTD2688A) 1111111 = 187.5mA (KTD2688) or 375mA(KTD2688A)

Table 8. LED2 Torch Current Register (Address 0x06, Read/Write)

Bit 7	Bits [6:0] LED2 Torch Current Code
Reserved	$I_{TORCH2} \text{ (mA)} = (\text{Code} + 1) \times 187.5\text{mA} / 128 \text{ (KTD2688)}$ $I_{TORCH2} \text{ (mA)} = (\text{Code} + 1) \times 375\text{mA} / 128 \text{ (KTD2688A)}$ 0000000 = 1.465mA (KTD2688) or 2.93mA(KTD2688A) 0000001 = 2.93mA (KTD2688) or 5.86mA(KTD2688A) 0111111 = 93.75mA (KTD2688, Default) or 187.5mA (KTD2688A, Default) 1000000 = 95.215mA (KTD2688) or 190.43mA(KTD2688A) 1111111 = 187.5mA (KTD2688) or 375mA(KTD2688A)

Table 9. Boost Converter Register (Address 0x07, Read/Write)

Bit 7 Software Reset	Bits [6:4] Flash Current On/Off Ramp Time	Bit 3 LED Short Protection	Bit 2 Boost Converter Mode	Bit 1 Switching Frequency	Bit 0 Current Limit
0 = Don't Reset (Default) 1 = Reset	000 = 512 μ s (Default) 001 = 1ms 010 = 2ms 011 = 4ms 100 = 8ms 101 = 16ms 110 = 32ms 111 = 64ms	0 = Disable 1 = Enable (Default)	0 = Boost Mode (Default) 1 = Pass Mode	0 = 2MHz (Default) 1 = 4MHz	0 = 1.9A 1 = 2.8A (Default)

Table 10. Timing Register (Address 0x08, Read/Write)

Bit 7 Torch Current On/Off Ramp Shape	Bits [6:4] Torch Current On/Off Ramp Time	Bits [3:0] Flash Time-out Duration
0 = Linear (Default) 1 = Exponential	000 = 0ms 001 = 1ms (Default) 010 = 32ms 011 = 64ms 100 = 128ms 101 = 256ms 110 = 512ms 111 = 1024ms	0000 = 10ms (KTD2688) or 40ms (KTD2688A) 0001 = 20ms (KTD2688) or 80ms (KTD2688A) 0010 = 30ms (KTD2688) or 120ms (KTD2688A) 0011 = 40ms (KTD2688) or 160ms (KTD2688A) 0100 = 50ms (KTD2688) or 200ms (KTD2688A) 0101 = 60ms (KTD2688) or 240ms (KTD2688A) 0110 = 70ms (KTD2688) or 280ms (KTD2688A) 0111 = 80ms (KTD2688) or 320ms (KTD2688A) 1000 = 90ms (KTD2688) or 360ms (KTD2688A) 1001 = 100ms (KTD2688) or 400ms (KTD2688A) 1010 = 150ms (KTD2688, Default) or 600ms (KTD2688A, Default) 1011 = 200ms (KTD2688) or 800ms (KTD2688A) 1100 = 250ms (KTD2688) or 1000ms (KTD2688A) 1101 = 300ms (KTD2688) or 1200ms (KTD2688A) 1110 = 350ms (KTD2688) or 1400ms (KTD2688A) 1111 = 400ms (KTD2688) or 1600ms (KTD2688A)

Table 11. Fault Flag 1 Register (Address 0x0A, Read Only)

Bit 7	Bit 6	Bit 5	Bit 4	Bit 3	Bit 2	Bit 1	Bit 0
0 = Normal 1 = TX	0 = Normal 1 = Vout Short	0 = Normal 1 = LED1 Short	0 = Normal 1 = LED2 Short	0 = Normal 1 = Current Limit	0 = Normal 1 = Thermal Shutdown	0 = Normal 1 = UVLO	0 = Normal 1 = Flash Time-out

Table 12. Fault Flag 2 Register (Address 0x0B, Read Only)

Bits [7:3]	Bit 2 LVP	Bit 1 OVP	Bit 0
Reserved	0 = Normal 1 = LVP	0 = Normal 1 = OVP	Reserved

Table 13. Device ID Register (Address 0x0C, Read Only)

Bits [7:6]	Bits [5:3] Device ID	Bits [2:0] Revision
Reserved	000	Reserved

Inductor Selection

KTD2688 is designed to use a 0.47µH to 1.0µH inductor. To prevent core saturation, ensure that the inductor saturation current rating exceeds the peak inductor current for the application. The worst-case peak inductor current can be calculated with the following formula:

$$I_{Peak(L)} = \frac{V_{OUT(MAX)} \times I_{LED(MAX)}}{\eta \times V_{IN(MIN)}} + \frac{V_{IN(MIN)} \times t_{ON(MAX)}}{2 \times L}$$

where η is the estimated efficiency.

For example, for a 1.0A LED current application, the peak inductor current for a 1.0µH inductor could be as high as (estimated 25% as the maximum duty ratio at 2MHz, efficiency of 80%, minimum input voltage of 3.5V, 4.0V of output voltage, and maximum load current conditions) :

$$I_{Peak(L)} = \frac{4.0V \times 1.0A}{0.8 \times 3.5V} + \frac{3.5V \times 0.125\mu s}{2 \times 1\mu H} = 1.65A$$

If the inductor value is smaller, the inductor peak current will increase. To maintain stable operation for the boost converter, the inductor peak current must be less than both the current limit threshold and the inductor saturation current rating. Manufacturer’s specifications of inductors list both the inductor DC current rating, which is a thermal limitation, and peak inductor current rating, which is determined by the saturation characteristics. Measurements at full load and high ambient temperature should be performed to ensure that the inductor does not saturate or overheat due to its parasitic resistance. Bench measurements are recommended to confirm actual inductor peak current and to ensure that the inductor does not saturate at maximum LED current and minimum input supply voltage.

Table 14. Recommended Inductor

Inductor Part Number	Value (µH)	DCR (mΩ)	Saturation Current (A)	Dimensions (mm)	Manufacturer
MDMK3030T1R0MM	1.0	43	4.3	3 x 3 x 1.2	Taiyo Yuden

Capacitor Selection

For good voltage filtering, low ESR ceramic capacitors are recommended. A 10-µF input capacitor is recommended for high current flash LEDs to improve transient behavior of the regulator and EMI behavior of the total power supply circuit. The input capacitor should be placed as close as possible to the VIN pin and the GND pin. The output capacitance required depends on the required LED current. A 10-µF low ESR ceramic output capacitor is recommended to minimize output voltage ripple, it should also be placed as close as possible to the VOUT pin and the GND pin.

Table 15. Recommended Ceramic Capacitor Vendors

Manufacturer	Website
Murata	www.murata.com
AVX	www.avx.com
Taiyo Yuden	www.t-yuden.com

PC Board Layout

Due to the fast switching transitions and high-current paths, careful PC board layout is required. The input and output bypass capacitors should be placed as close to the IC as possible, these two capacitors' ground should be placed together and close to IC GND pin. Minimize the trace length between the IC and the inductor, and keep the trace short, direct, and wide.

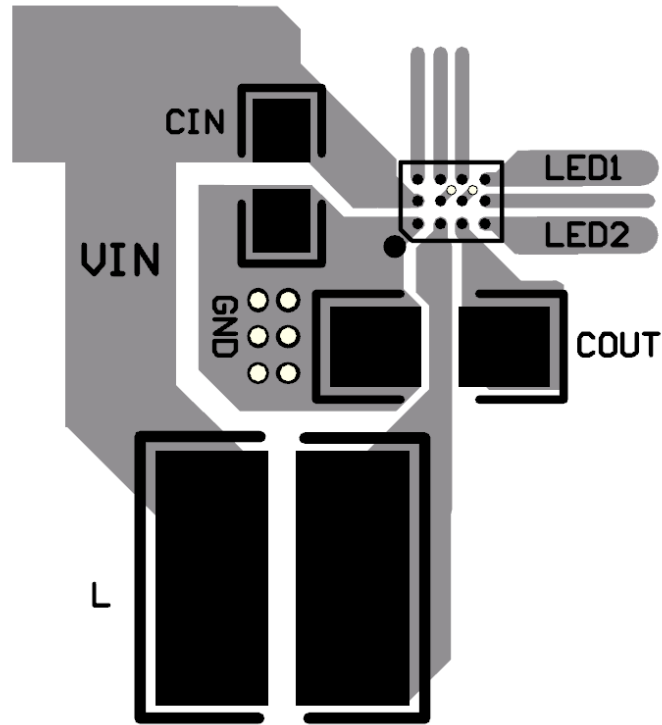

Figure 10. CSP Recommended PCB Layout