

Single Flash LED Driver with Programmable 1.5A Current Source

Features

- High efficiency synchronous boost converter with 2MHz/4MHz switching frequency option
- I²C interface programming and hardware STROBE control
- Single-channel programmable current source
 - Flash/Torch/IR modes
 - Flash: Up to 1.5A (128 Levels)
 - Torch: Up to 376mA (128 Levels)
 - Input low voltage protection function
 - Flash time-out protection
 - LED cathode ground connection for improved thermal dissipation
 - LED open/short protection
- I²C fault read back
- RoHS and Green compliant
- Pb-free Packages: WLCSP24-8 or UDFN22-10L
- -40°C to +85°C Ambient Temperature Range

Applications

- Smartphones and Tablets
- IR LED Driver
- Digital Cameras

Brief Description

KTD2690 is the ideal power solution for high-power flash LEDs. The highly integrated synchronous boost converter and current source can support up to 1.5A flash and up to 376mA torch current. The device provides a very small total solution in portable application. It has both I²C interface and hardware STROBE pin for maximum control flexibility. The integrated current source on/off and current settings in Flash/Torch/IR modes can be programmed by the I²C interface. A selectable input low voltage protection function can prevent a system reset under low battery condition.

Various protection features are integrated into KTD2690, including cycle-by-cycle input current limit protection, output overvoltage protection, LED fault (open or short) protection, flash timeout protection and thermal shutdown protection.

KTD2690 is available in a RoHS and Green 8-ball 1.519mm x 0.808mm x 0.500mm WLCSP package with 0.35mm pitch or a 10-lead 2mm x 2mm x 0.55mm UDFN package.

Typical Application

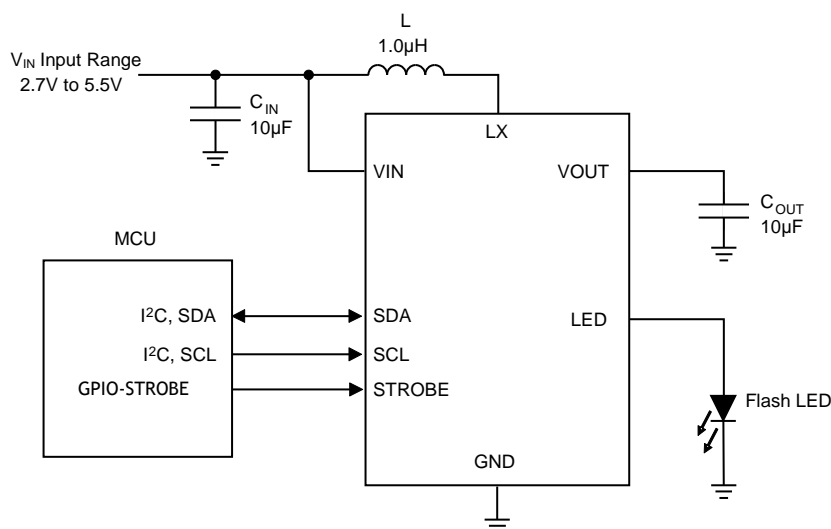

Pin Descriptions

Pin #		Name	Function
WLCSP24-8	UDFN22-10		
A1	1,10	GND	Ground pin
A2	2	VIN	Input supply pin for the device. Connect a 10µF ceramic capacitor to GND.
B1	8,9	LX	Switching pin of the boost converter.
B2	3	STROBE	Active high FLASH/IR enable pin. There is an internal 300kΩ pull-down resistor at this pin to GND.
C1	7	VOUT	Output pin of the boost converter. Connect a 10µF ceramic capacitor to GND
C2	4	SDA	Bi-direction data pin of the I ² C interface.
D1	6	LED	Regulated output current source.
D2	5	SCL	Clock input pin of the I ² C interface.
–	MC	GND	Metal chassis. Connect to ground for electrical and thermal usage.

WLCSP24-8

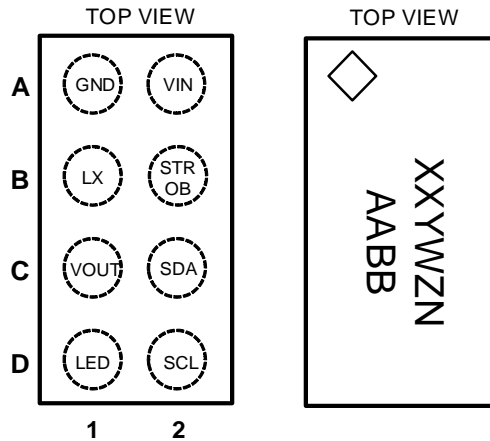

8-Bump 1.519mm x 0.808mm x 0.500mm
WLCSP Package

Top Mark

XX = Device ID Code, YW = Date Code, ZN = Serial Number,
AABB = Wafer Map Coordinates

UDFN22-10

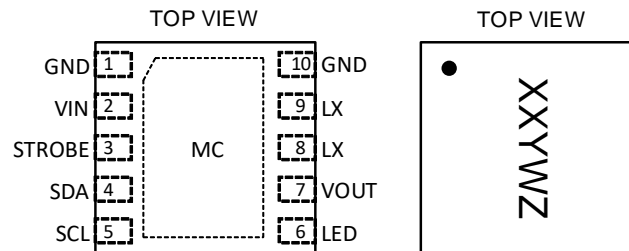

10-Lead 2mm x 2mm x 0.55mm
UDFN Package

Top Mark

XX = Device Code,
YW = Date Code, Z = Assembly Code

Absolute Maximum Ratings¹

(T_A = 25°C unless otherwise noted)

Symbol	Description	Value	Units
V _{IN} , V _{OUT}	Input and output voltage pins	-0.3 to 6	V
LED	Current source pin	-0.3 to V _{OUT} +0.3	V
SCL, SDA, STROBE	Control pins	-0.3 to V _{IN} +0.3	V
LX	Switching pin	-0.3 to 6.5	V
T _J	Junction Operating Temperature Range	-40 to 150	°C
T _S	Storage Temperature Range	-65 to 150	°C
T _{LEAD}	Maximum Soldering Temperature (at leads, 10 sec)	300	°C
ESD	HBM electrical static discharge	±2.0	kV

Thermal Capabilities

Symbol	Description	Value	Units
WLCSP24-8			
θ _{JA}	Thermal Resistance – Junction to Ambient ²	125	°C/W
P _D	Maximum Power Dissipation at T _A ≤ 25°C	1.0 ³	W
ΔP _D /ΔT	Derating Factor Above T _A = 25°C	-8.0	mW/°C
UDFN22-10			
θ _{JA}	Thermal Resistance – Junction to Ambient ²	65.15	°C/W
P _D	Maximum Power Dissipation at T _A ≤ 25°C	1.92	W
ΔP _D /ΔT	Derating Factor Above T _A = 25°C	-15.35	mW/°C

Recommended Operating Range

Description	Value
V _{IN} , V _{OUT} , LED	2.7V to 5.5V
LX	≤ 6V

Ordering Information

Part Number ⁴	Marking	Ambient Operating Temperature	Package
KTD2690ERAA-TA	RGYWZNAABB ⁵	-40°C to +85°C	WLCSP24-8
<i>KTD2690EVAB-TA</i>	<i>RGYWZ</i> ⁶	<i>-40°C to +85°C</i>	<i>UDFN22-10</i>

- Stresses above those listed in Absolute Maximum Ratings may cause permanent damage to the device. Functional operation at conditions other than the operating conditions specified is not implied. Only one Absolute Maximum rating should be applied at any one time.
- Junction to Ambient thermal resistance is highly dependent on PCB layout. Values are based on thermal properties of the device when soldered to an EV board.
- Internal shutdown circuitry protects the device from permanent damage. Thermal shutdown activated at typically T_J = 150°C and reengages at typically 130°C.
- For part numbers in *Italic*, please contact your local sales representative for availability.
- RG = Device ID Code, YW = Date Code, ZN = Serial Number, AABB = Wafer Map Coordinates.
- RG = Device Code, YW = Date Code, Z = Assembly Code

Electrical Characteristics⁷

Unless otherwise noted, the *Min* and *Max* specs are applied over the full ambient operation temperature range of -40°C to +85°C, while *Typ* values are specified at room temperature (25°C), $V_{IN} = 3.6V$, $V_{OUT} = 4V$.

Symbol	Description	Conditions	Min	Typ	Max	Units	
VIN Supply							
V_{IN}	Input operating range		2.7		5.5	V	
I_Q	IC operating current	Not switching, pass mode		0.6		mA	
I_{SB}	V_{IN} pin standby current	Device disabled, I ² C is Standby		0.5	2	μA	
UVLO	Input under voltage lockout	VIN Rising		2.4		V	
UVLO _{HYST}	UVLO hysteresis			0.10		V	
Boost Converter							
I_{LIM}	Peak NMOS current limit	Reg 0x01, bit[5] = '0'		1.9		A	
		Reg 0x01, bit[5] = '1'		2.8		A	
F_{SW}	Oscillator frequency	Reg 0x01, bit[6] = '0'		2.0		MHz	
		Reg 0x01, bit[6] = '1'		4.0		MHz	
D_{MAX}	Maximum duty cycle	$F_{SW} = 2MHz$		88		%	
V_{OVP}	Internal OV threshold of VOUT	VOUT Rising		5		V	
V_{LVP}	V_{IN} low voltage protection threshold	Reg 0x02, bit[7:5] = '000', $T_A = 25^\circ C$		2.9		V	
Current Sources							
I_D	Output Current Accuracy, Flash Mode	LED = 1500mA setting	$T_A = 25^\circ C$	1425	1500	1575	mA
	Output Current Accuracy, Torch Mode	LED = 376mA setting		342	376	409	mA
V_{HR}	LED Current Source Headroom	LED = 1500mA setting	Flash Mode		500		mV
		LED = 1000mA setting	Flash Mode		490		mV
		LED = 376mA setting	Torch Mode		300		mV
$T_{TIMEOUT}$	Flash Timeout Period	Reg 0x02, bit[4:1] = '1100'		1000		ms	
I²C-Compatible Voltage Specifications (SCL, SDA)							
V_{IL}	Input Logic Low Threshold				0.4	V	
V_{IH}	Input Logic High Threshold		1.4			V	
V_{OL}^8	SDA Output Logic Low	$I_{SDA} = 3mA$			0.4	V	
I²C-Compatible Timing Specifications (SCL, SDA), see Figure 1⁸							
t_1	SCL (Clock Period)		2.5			μs	
t_2	Data In Setup Time to SCL High		100			ns	
t_3	Data Out Stable After SCL Low		0			ns	
t_4	SDA Low Setup Time to SCL, Low (Start)		100			ns	
t_5	SDA High Setup Time to after SCL, High (Stop)		100			ns	
Control – STROBE							
V_{TH-L}	Input Logic Low Threshold				0.4	V	
V_{TH-H}	Input Logic High Threshold		1.4			V	
$R_{PULL-down}$	Internal Pull Down Resistor			300		kΩ	
Thermal Shutdown⁸							
T_{J-TH}	Thermal shutdown threshold			150		°C	
	Thermal shutdown hysteresis			20		°C	

7. KTD2690 is guaranteed to meet performance specifications over the -40°C to +85°C ambient operating temperature range by design, characterization and correlation with statistical process controls.

8. Guaranteed by design, characterization and statistical process control methods; not production tested.

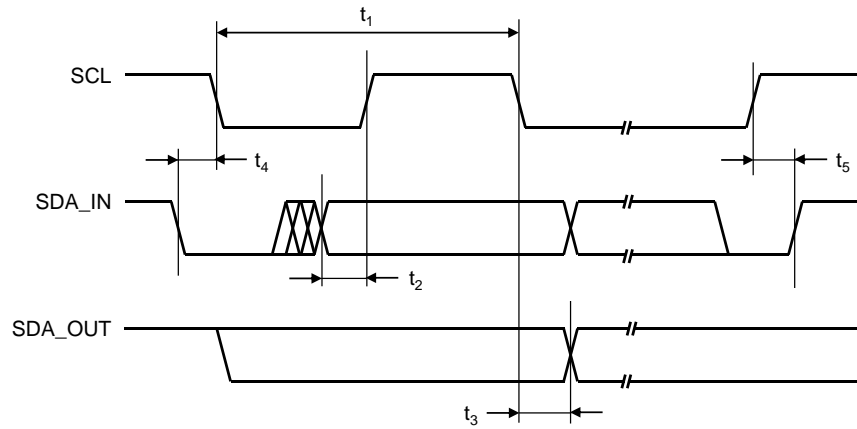
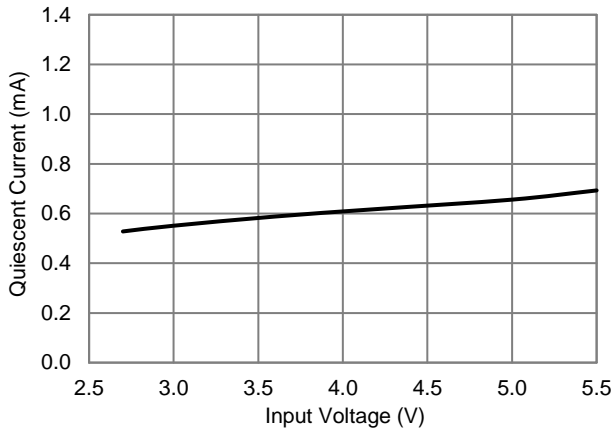

Figure 1. I²C Compatible Interface Timing

Typical Characteristics

$V_{IN} = 3.6V$, $L = 1.0\mu H$, $C_{IN} = 10\mu F$, $C_{OUT} = 10\mu F$, $T_A = 25^\circ C$ unless otherwise specified.

Input Quiescent Current vs VIN



Input Standby Current vs VIN

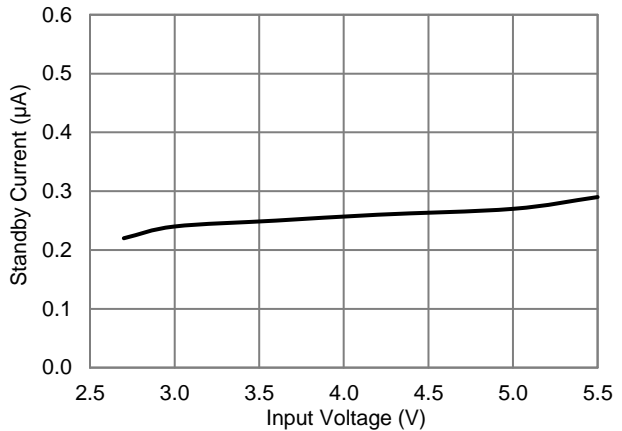

LED Torch Current vs Code⁹

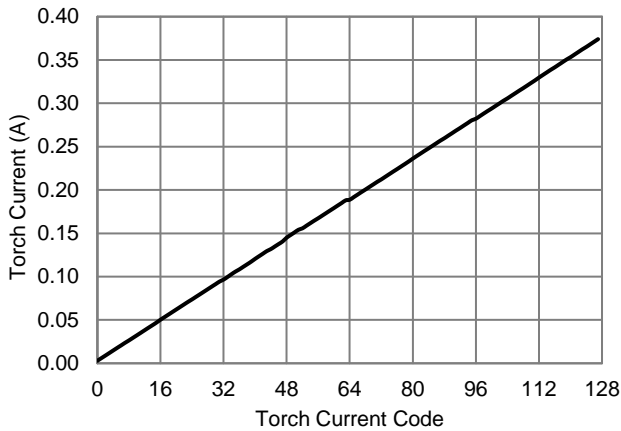

LED Flash Current vs Code⁹

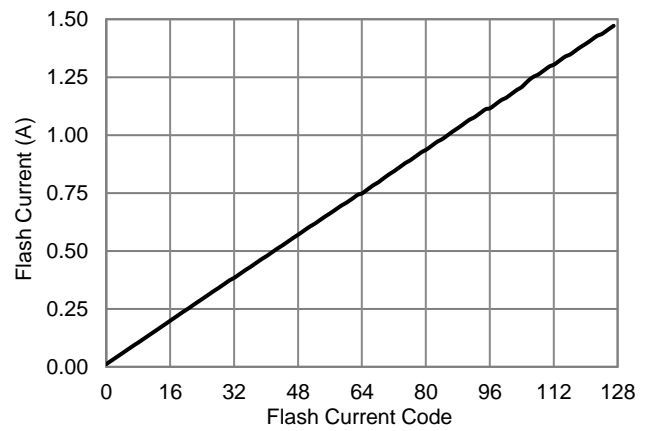

Switching Frequency vs Input Voltage

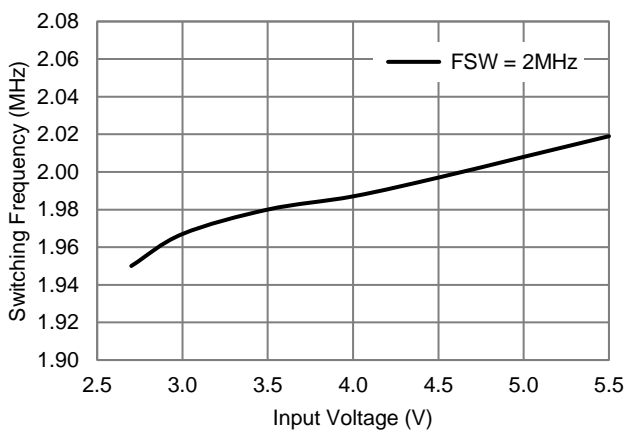

Switching Frequency vs Input Voltage

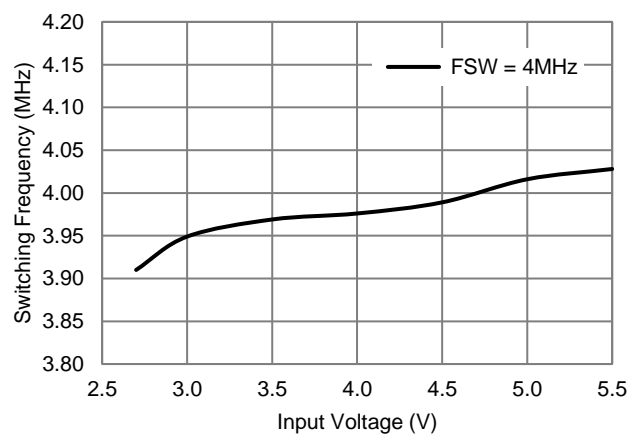

9. The maximum code value is 127 (7-bit).

Typical Characteristics

$V_{IN} = 3.6V$, $L = 1.0\mu H$, $C_{IN} = 10\mu F$, $C_{OUT} = 10\mu F$, $FSW = 2MHz$, $T_A = 25^\circ C$ unless otherwise specified.

Input Logic Threshold vs VIN

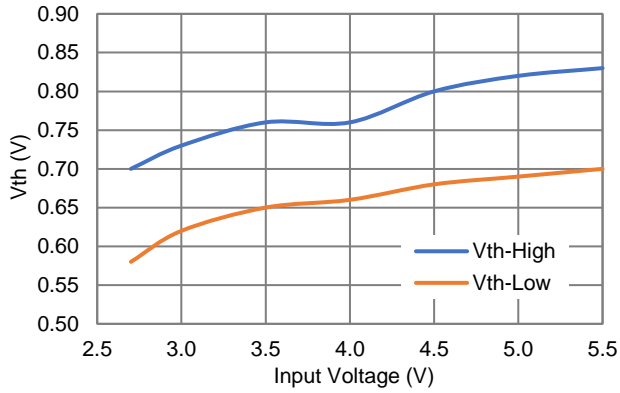

LED Torch Current vs VIN

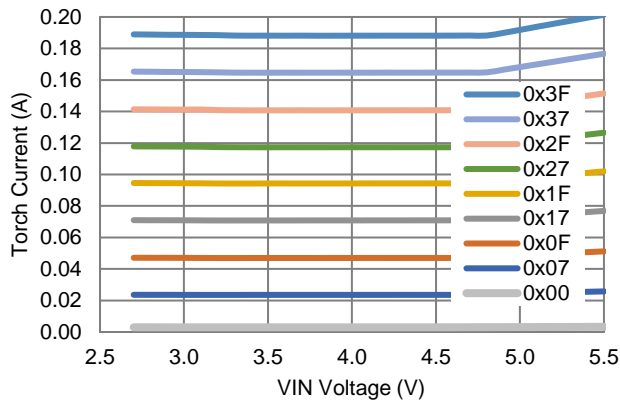

LED Torch Current vs VIN

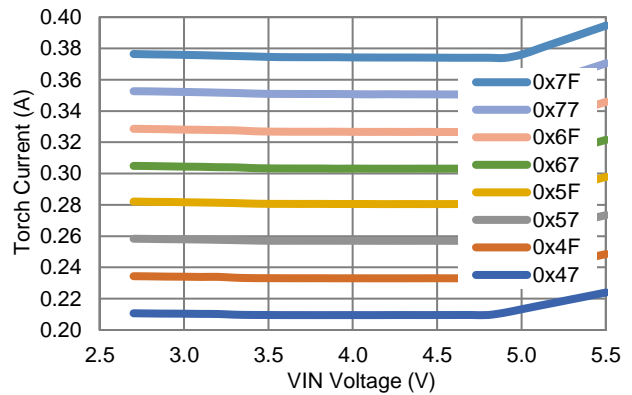

LED Flash Current vs VIN

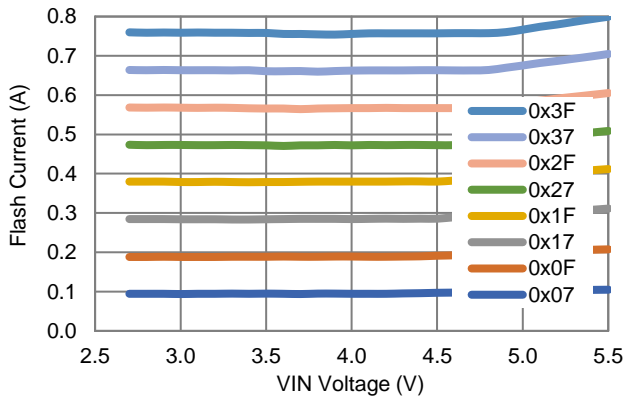

LED Flash Current vs VIN

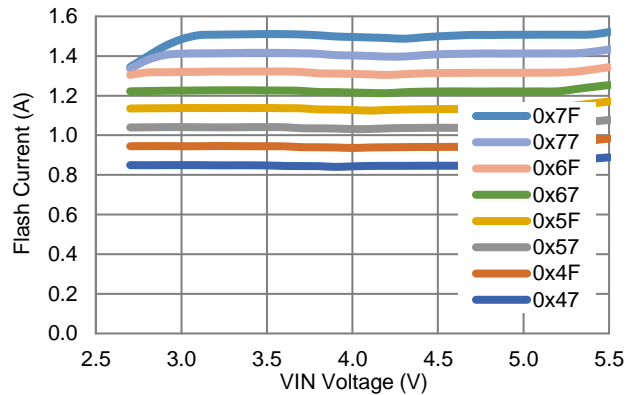

Typical Characteristics

$V_{IN} = 3.6V$, $L = 1.0\mu H$, $C_{IN} = 10\mu F$, $C_{OUT} = 10\mu F$, $FSW = 2MHz$, $T_A = 25^\circ C$ unless otherwise specified.

Flash Current vs VIN (code 0x7F, 1.5A)

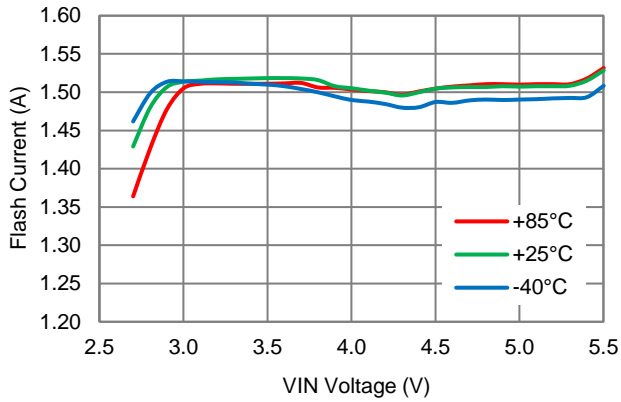

Flash Current vs VIN (code 0x65, 1.2A)

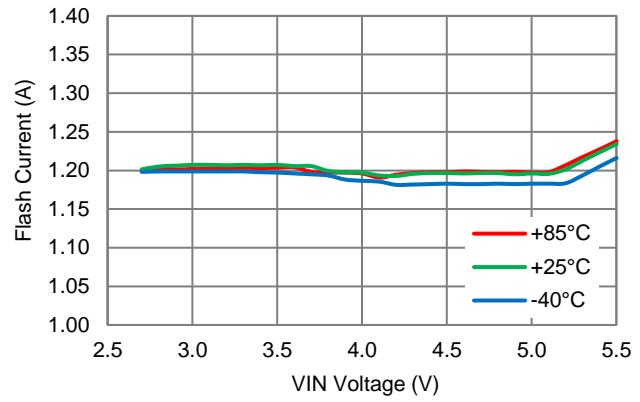

Flash Current vs VIN (code 0x54, 1.0A)

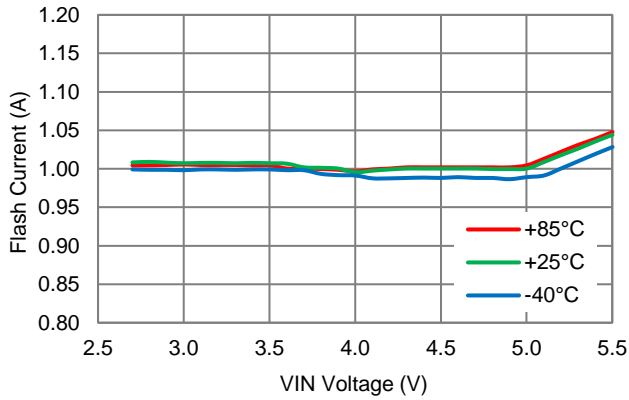

Torch Current vs VIN (code 0x7F, 376mA)

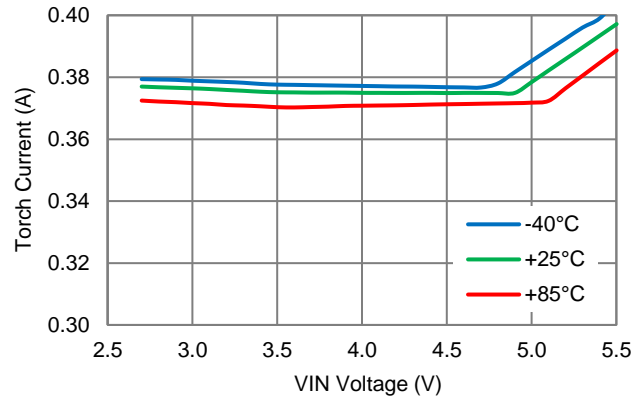

Torch Current vs VIN (code 0x57, 258mA)

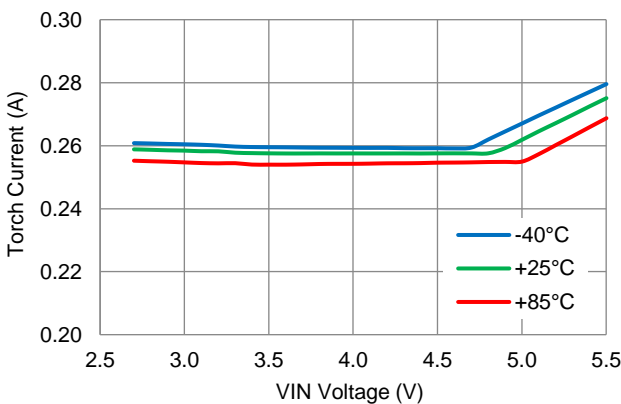

Torch Current vs VIN (code 0x3F, 188mA)

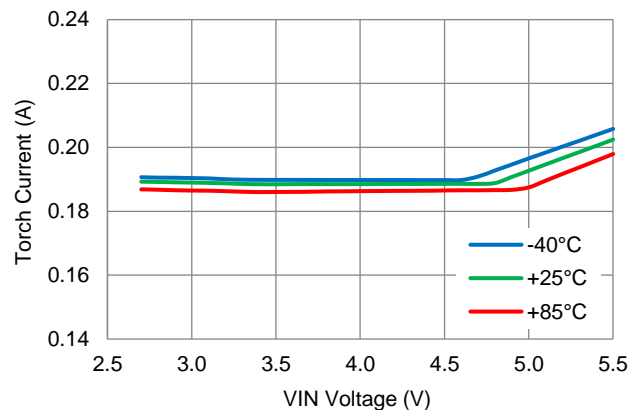

Typical Characteristics

$V_{IN} = 3.6V$, $L = 1.0\mu H$, $C_{IN} = 10\mu F$, $C_{OUT} = 10\mu F$, $T_A = 25^\circ C$ unless otherwise specified.

Flash Turn On by I2C

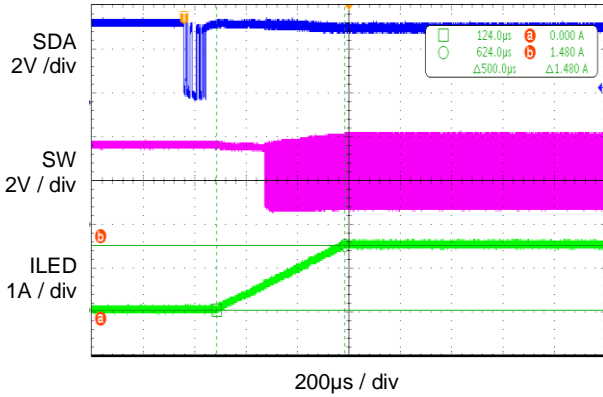

Flash Time-Out (40ms setting)

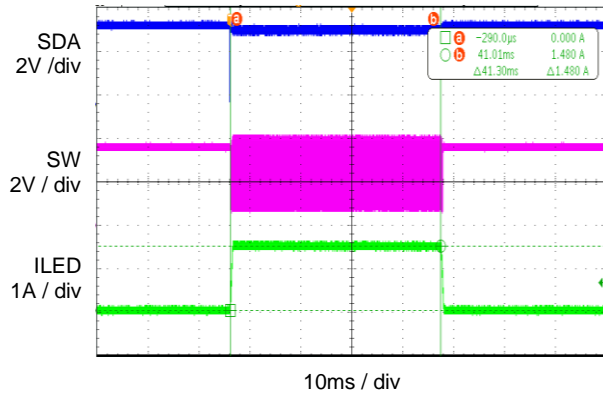

Torch On by I2C

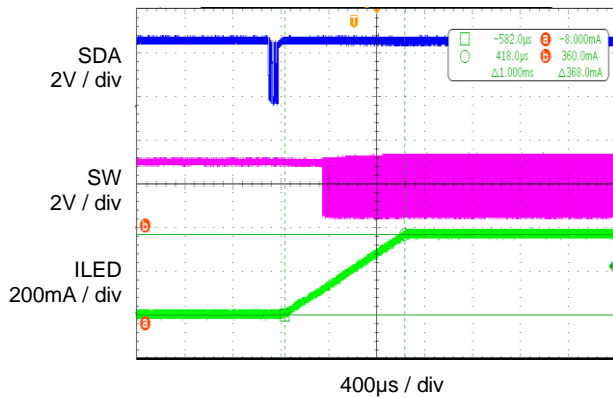

Torch Off by I2C

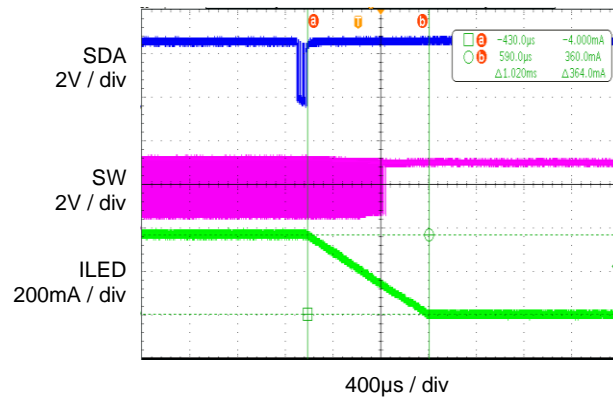

Strobe Turn On

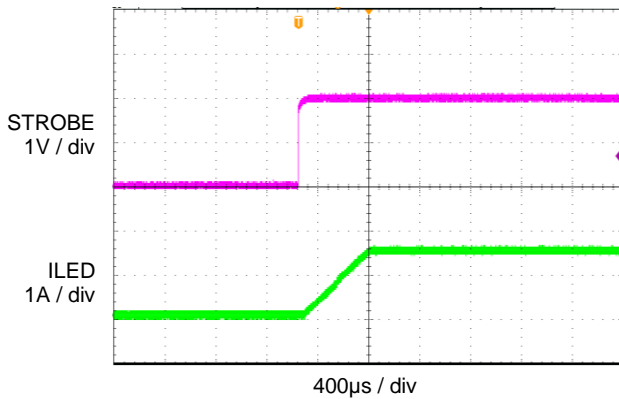

Strobe Turn Off

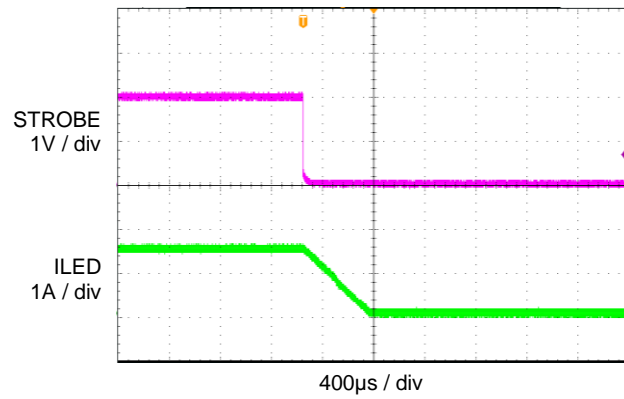

Typical Characteristics

$V_{IN} = 3.6V$, $L = 1.0\mu H$, $C_{IN} = 10\mu F$, $C_{OUT} = 10\mu F$, $T_A = 25^\circ C$ unless otherwise specified.

Strobe Edge Triggered (40ms Time-Out)

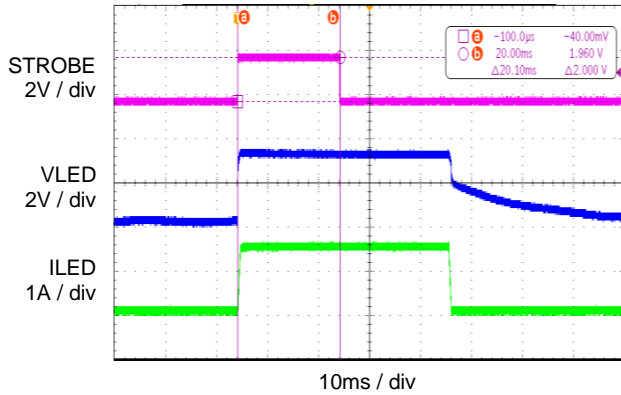

Strobe Level Triggered

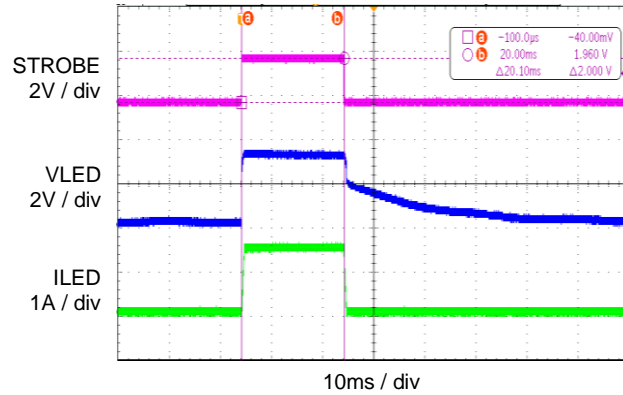

Strobe On to Flash Time-Out

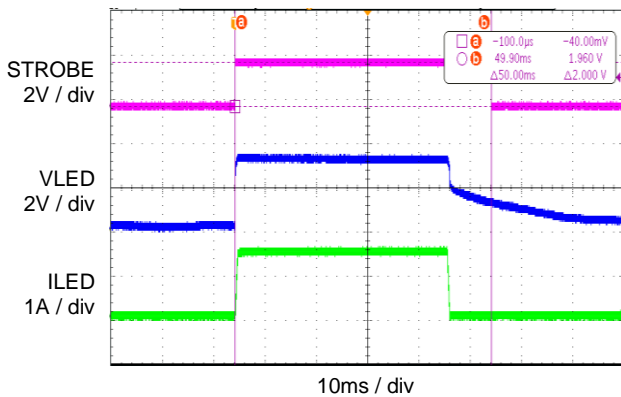

IR Mode

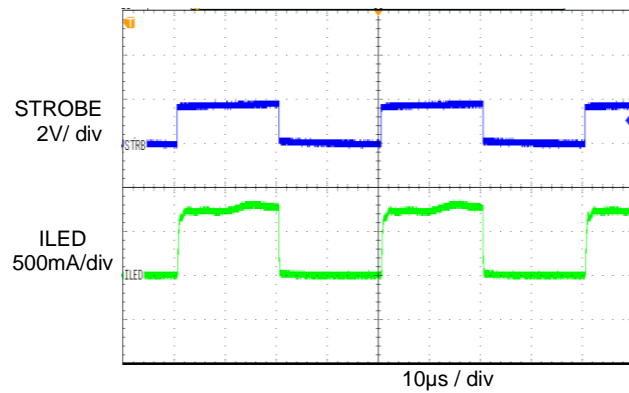

Boost Switching Waveform (FSW = 2MHz)

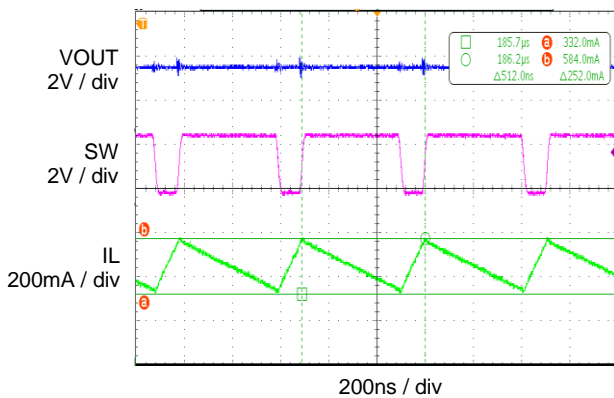

Boost Switching Waveform (FSW = 4MHz)

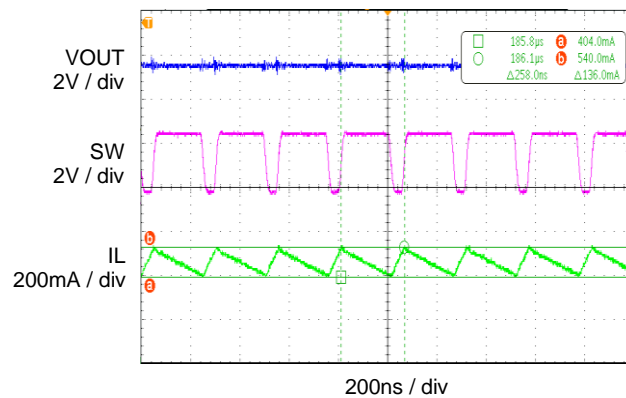

Typical Characteristics

$V_{IN} = 3.6V$, $L = 1.0\mu H$, $C_{IN} = 10\mu F$, $C_{OUT} = 10\mu F$, $T_A = 25^\circ C$ unless otherwise specified.

**LVP Threshold Disabled vs Enabled
(LVP = 2.9V, IFLASH = 500mA)**

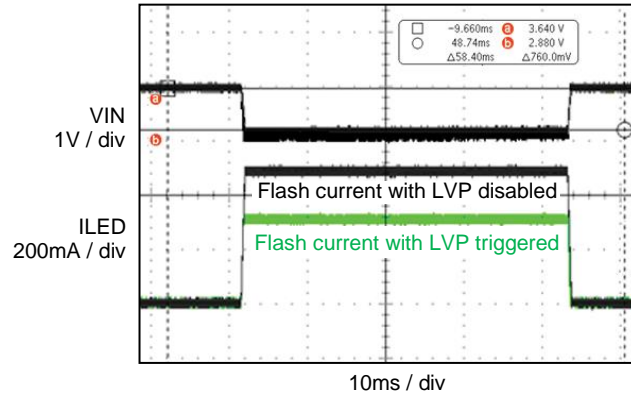

Functional Block Diagram

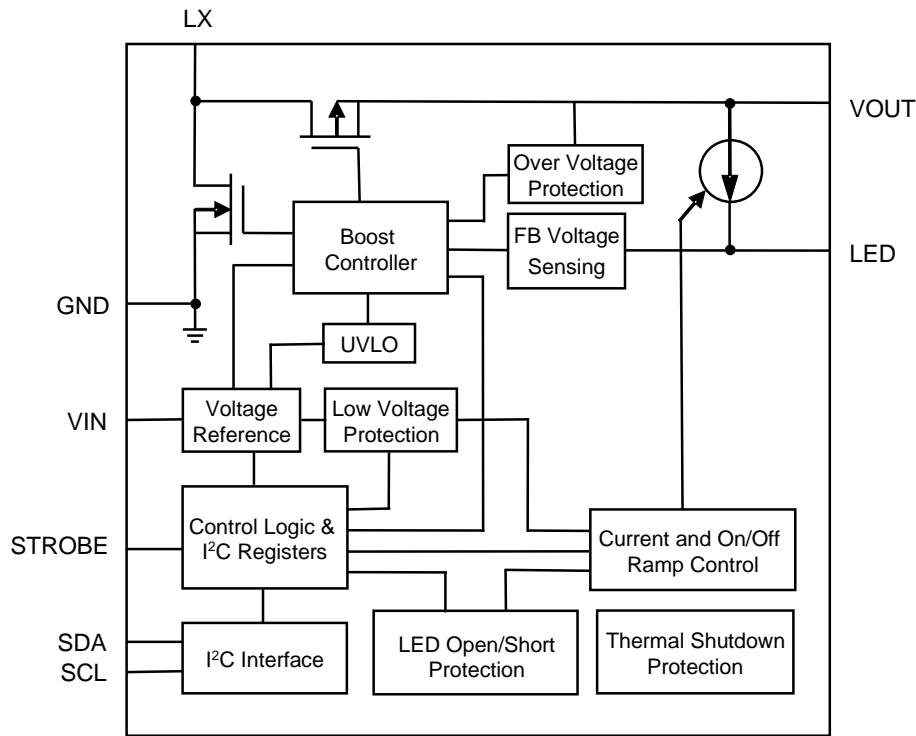

Functional Description

KTD2690 is a high-power flash LED driver capable of delivering up to 1.5A of LED current. It consists of a high switching frequency synchronous boost converter and a programmable current source in a small WLCSF package size. The inductor-based boost converter integrates two low $R_{DS(on)}$ power MOSFETs, and operates at a switching frequency of 2.0MHz (default) or 4MHz to minimize the size of the external inductor and capacitors. Unlike a traditional DC-DC boost converter with a fixed output voltage, KTD2690 dynamically adjusts the output voltage depending on the flash LED forward voltage and current, it only boosts the output to a voltage sufficient to drive the LEDs at the programmed output current. The use of unique control scheme maintains accurate current regulation in the current source while minimizing the output voltage, increasing the overall conversion efficiency.

The control interface is designed for maximum flexibility and compatibility with various types of system controls. KTD2690 is mainly programmed and controlled via an I²C-compatible interface, but also includes logic input that can provide a hardware flash enable (STROBE). The I²C control features include the current control of the current source in Flash/Torch/IR modes, flash safety time-out protection, boost converter current limit and switching frequency options, and various fault events read back. In addition, KTD2690 also has various protection features including LED open and short protections.

Flash Mode

In Flash mode, LED current can be programmed up to 1.5A. The flash current values are controlled by I²C register 0x03. The flash mode can be activated either by I²C register 0x01 bits[1:0] or by STROBE pin rising edge when STROBE pin is enabled, and it can be deactivated by I²C register 0x01 bits[1:0], or by STROBE pin, or by flash time-out event. After the flash time-out event, I²C register 0x01 bits[1:0] will be reset to standby mode.

If using STROBE pin to control the flash mode, there is an option to select when the flash mode is deactivated. If Strobe Type is selected as Level Triggered, flash mode is deactivated during STROBE pin falling edge or flash time-out event, as shown in Figure 2. If Strobe Type is selected as Edge Triggered, flash mode is only deactivated during flash time-out event, STROBE pin falling edge cannot deactivate it, as shown in Figure 3.

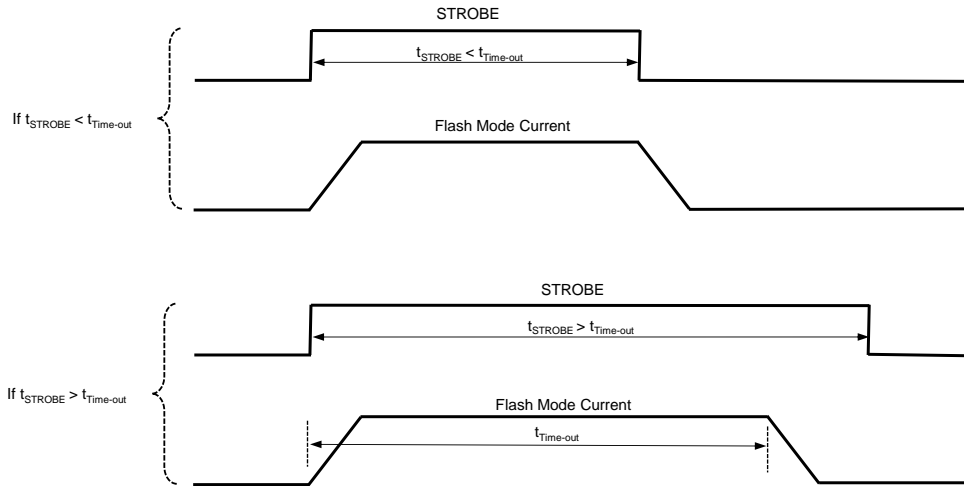

Figure 2. Flash Mode Current Controlled by STROBE (Level Triggered)

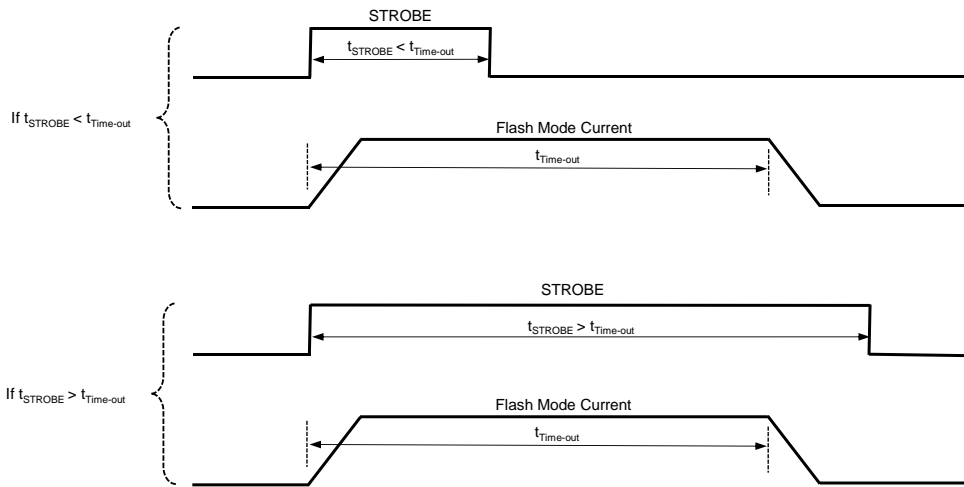

Figure 3. Flash Mode Current Controlled by STROBE (Edge Triggered)

Torch Mode

In Torch mode, LED current can be programmed up to 376mA. The torch current value is controlled by I²C register 0x04. The torch on/off ramp time is controlled by I²C register 0x02 bit [0].

IR Mode

In IR mode, the current setting is similar to Flash mode setting, which is controlled by I²C register 0x03. For IR mode, I²C register 0x01 bits[1:0] should be set to '01' and STROBE pin should be enabled, then STROBE pin rising edge can activate IR mode, and STROBE pin falling edge or flash time-out event can deactivate IR mode. In IR mode, the current source is enabled to the full current setting with no delay or slow ramp during STROBE rising edge, and it is fully turned off immediately with no delay or slow ramp during STROBE falling edge. This allows IR current to follow the fast frequency IR transmission of the STROBE pin signal. For IR mode, STROBE pin only allows Level Triggered, and doesn't allow Edge Triggered, but it is still protected by flash time-out if STROBE width is too long. In IR mode, since the STROBE width can be very short, the boost converter might

not have enough time to boost the output high enough to regulate the current sources, it is recommended to set the boost converter to Pass mode and let the output voltage be equal to the input voltage.

Table 1 summarizes the control of Shutdown/Standby/Flash/Torch/IR modes.

Table 1. Mode Control Table

I ² C register 0x01 bits[1:0]	STROBE Enable(0x01 bit[2])	STROBE Pin	FUNCTION
00	0	X	Standby
00	1	Positive Edge	External Flash Mode
10	X	X	Internal Torch Mode
11	X	X	Internal Flash Mode
01	0	X	IR Standby Mode
01	1	0	IR Standby Mode
01	1	Positive Edge	IR Mode

VIN Low Voltage Protection (LVP)

In flash mode, the high LED current might pull the input battery voltage low. KTD2690 has VIN Low Voltage Protection (LVP) function to adjust the LED current based on the input voltage to prevent the battery voltage from going too low and trigger a system reset. The adjustable LVP threshold has 8 steps, ranging from 2.9V to 3.6V with 0.1V step. During the flash current turn on ramp, if VIN drops below the LVP threshold, after 4μs deglitch delay, the LED current stops rising and remains at the last value. After that, even if VIN changes, the LED current setting will not change during the remaining of the flash event. The LVP function only work in flash mode.

LVP event writes a '1' into the I²C register 0x05 bit[6], this fault flag bit resets to '0' once the register is read via I²C interface, or by VIN power on reset, or by I²C software reset.

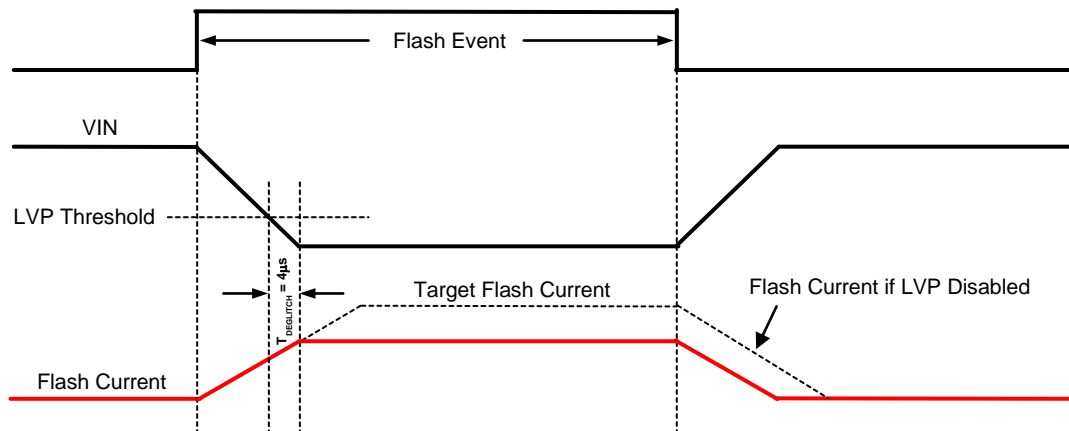

Figure 4. LVP Function

Flash Time-out

The Flash time-out function sets the maximum time of one flash event, whether a flash stop command is received or not. The device has 16 flash time-out settings controlled by I²C register 0x02 bits [4:1], ranging from 40ms to 1600ms. Flash time-out feature applies to both flash and IR modes. Flash time-out event writes a '1' to the I²C register 0x05 bit[0], this fault flag is reset to '0' when it is read through I²C interface, or by VIN power on reset, or by I²C software reset.

UVLO

The device has under voltage lock-out (UVLO) function to monitor the input voltage. Once the input voltage VIN drops below UVLO falling threshold (around 2.35V), the output current is disabled and the boost converter stops switching. Once the input voltage increases above UVLO rising threshold (around 2.5V), the output current resumes its previous setting. UVLO event writes a '1' to the I²C register 0x05 bit[1], this fault flag is reset to '0' once I²C register 0x05 is read through I²C interface, or by VIN power on reset, or by I²C software reset. Even it is not read back, the device resumes normal operation once the input voltage comes back above UVLO rising threshold.

Thermal Shutdown

In flash or IR mode, the device has thermal shutdown protection, when the IC temperature goes above thermal shutdown rising threshold (around 150°C), the output current is disabled and the boost converter stops switching. Once the IC temperature drops below thermal shutdown falling threshold (around 130°C), the output current resumes to its previous setting. Thermal shutdown writes a '1' to the I²C register 0x05 bit[2], this fault flag is reset to '0' once I²C register 0x05 is read back through I²C interface, or by VIN power-on-reset, or by I²C software reset. Even if the register is not read back, the device resumes normal operation once the IC temperature goes below thermal shutdown falling threshold.

Current Limit

The boost converter has cycle-by-cycle current limit protection for its power NMOS when it is switching. Once the current limit is reached, the power NMOS turns off until the next switching cycle. The device has two current limit settings (2.8A and 1.9A) controlled by I²C register 0x01 bit[5]. Current limit event writes a '1' to the I²C register 0x05 bit[4], this fault flag is reset to '0' once I²C register 0x05 is read back through I²C interface, or by VIN power-on-reset, or by I²C software reset. The current limit function is disabled when the device is working in Pass mode because it doesn't sense power NMOS current.

LED Short Protection

After turn-on ramp of the output current, the device senses the LED pin voltage. If the LED pin voltage drops below around 0.5V, after about 256μs deglitch time, the LED channel is disabled. LED short condition writes a '1' to the I²C register 0x05 bit[5], this fault flag is reset to '0' once I²C register 0x05 is read back, or by VIN power-on-reset, or by I²C software reset.

Once the LED short condition is removed, the device can resume normal operation by following the sequence below.

- 1) Select Standby mode by writing to Reg 0x01 [1:0] = 00,
- 2) Select the mode, IR or Torch or Flash, by writing to Reg 0x01[1:0] = 01 or 10 or 11 respectively.

It is not required to read Reg 0x05 to clear the LED fault flag.

LED Open Protection and Overvoltage Protection (OVP)

If Boost mode is enabled while an LED is open during normal operation, the output voltage goes up to the overvoltage protection (OVP) threshold (around 5V), then the device senses the LED voltage to automatically detect whether the LED channel is open and then disables the open channel. OVP event writes a '1' to the I²C register 0x05 bit[7], this fault flag is reset to '0' once I²C register 0x05 is read back, or by VIN power-on-reset, or by I²C software reset.

Once the LED open condition is removed, the driver can resume normal operation by following the sequence below.

- 1) Select Standby mode by writing to Reg 0x01 [1:0] = 00,
- 2) Select the mode, IR or Torch or Flash, by writing to Reg 0x01[1:0] = 01 or 10 or 11 respectively.

Software Reset

The device has a software reset function controlled by I²C register 0x06 bit[7]. Writing a '1' to this bit resets all I²C registers to their default settings and reset all fault flags; this bit will also be reset to '0' automatically.

Application Information

I²C Serial Data Bus

KTD2690 supports the I²C bus protocol. A device that sends data onto the bus is defined as a transmitter and a device receiving data as a receiver. The device that controls the bus is called a master, whereas the devices controlled by the master are known as slaves. A master device must generate the serial clock (SCL), control bus access and generate START and STOP conditions to control the bus. KTD2690 operates as a slave on the I²C bus. Within the bus specifications a standard mode (100kHz maximum clock rate) and a fast mode (400kHz maximum clock rate) are defined. KTD2690 works in both modes. Connections to the bus are made through the open-drain I/O lines SDA and SCL.

The following bus protocol has been defined in Figure 5:

- Data transfer may be initiated only when the bus is not busy.
- During data transfer, the data line must remain stable whenever the clock line is HIGH. Changes in the data line while the clock line is high are interpreted as control signals.

Accordingly, the following bus conditions have been defined:

Bus Not Busy

Both data and clock lines remain HIGH.

Start Data Transfer

A change in the state of the data line, from HIGH to LOW, while the clock is HIGH, defines a START condition.

Stop Data Transfer

A change in the state of the data line, from LOW to HIGH, while the clock line is HIGH, defines the STOP condition.

Data Valid

The state of the data line represents valid data when, after a START condition, the data line is stable for the duration of the HIGH period of the clock signal. The data on the line must be changed during the LOW period of the clock signal. There is one clock pulse per bit of data.

Each data transfer is initiated with a START condition and terminated with a STOP condition. The number of data bytes transferred between START and STOP conditions are not limited, and are determined by the master device. The information is transferred byte-wise and each receiver acknowledges with a ninth bit.

Acknowledge

Each receiving device, when addressed, is obliged to generate an acknowledge after the reception of each byte. The master device must generate an extra clock pulse that is associated with this acknowledge bit.

A device that acknowledges must pull down the SDA line during the acknowledge clock pulse in such a way that the SDA line is stable LOW during the HIGH period of the acknowledge-related clock pulse. Setup and hold times must also be taken into account.

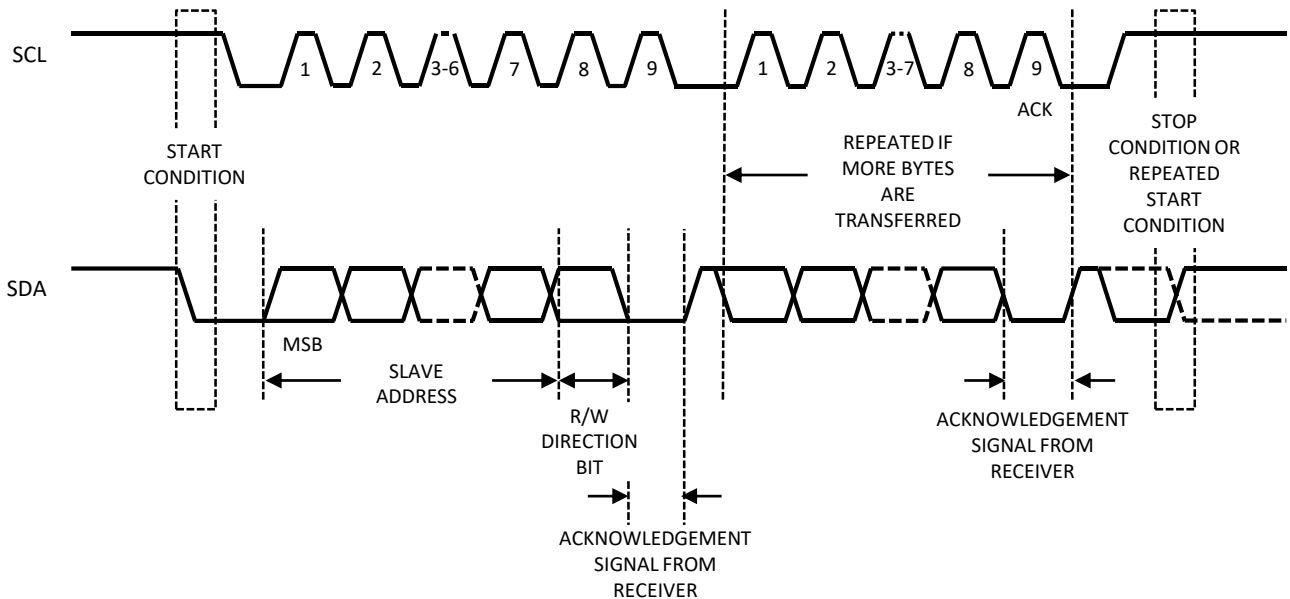

Figure 5. Data Transfer on I²C Serial Bus

KTD2690 7-bit slave device address is 1100100 binary (or 0x64h).

There are two kinds of I²C data transfer cycles: write cycle and read cycle.

I²C Write Cycle

For I²C write cycle, data is transferred from a master to a slave. The first byte transmitted is the 7-bit slave address plus one bit of '0' for write. Next follows a number of data bytes. The slave returns an acknowledge bit after each received byte. Data is transferred with the most significant bit (MSB) first. Figure 6 shows the sequence of the I²C write cycle.

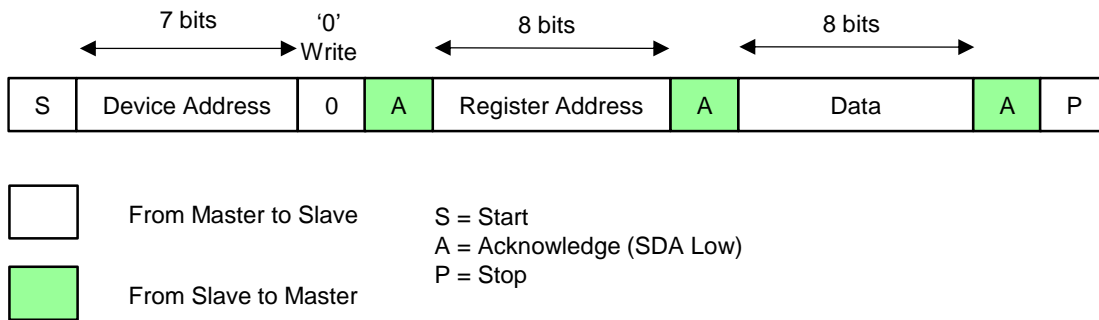

Figure 6. I²C Write Cycle

I²C Write Cycle Steps:

- Master generates start condition.
- Master sends 7-bit slave address and 1-bit data direction '0' for write.
- Slave sends acknowledge if the slave address is matched.
- Master sends 8-bit register address.
- Slave sends acknowledge.
- Master sends 8-bit data for that addressed register.
- Slave sends acknowledge.
- If master sends more data bytes, the register address will be incremented by one after each acknowledge.
- Master generate stop condition to finish the write cycle.

I²C Read Cycle

For I²C read cycle, data is transferred from a slave to a master. But to start the read cycle, master needs to write the register address first to define which register data to read. Figure 7 shows the steps of the I²C read cycle.

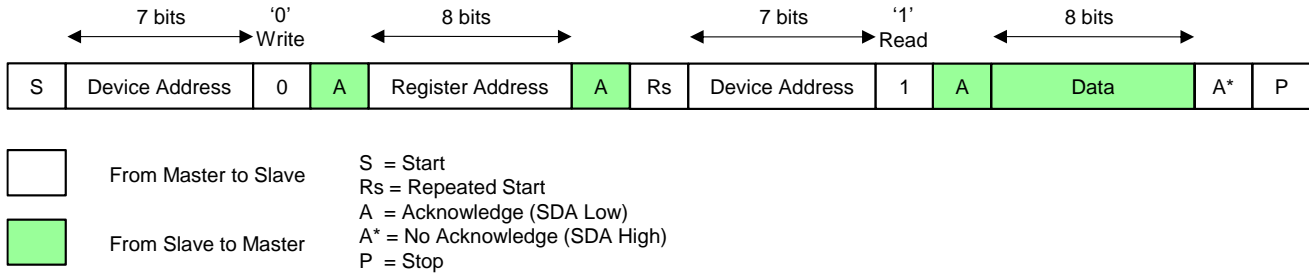

Figure 7. I²C Read Cycle

I²C Read Cycle Steps:

- Master generates start condition.
- Master sends 7-bit slave address and 1-bit data direction '0' for write.
- Slave sends acknowledge if the slave address is matched.
- Master sends 8-bit register address.
- Slave sends acknowledge.
- Master generates repeated start condition.
- Master sends 7-bit slave address and 1-bit data direction '1' for read.
- Slave sends acknowledge if the slave address is matched.
- Slave sends the data byte of that addressed register.
- If master sends acknowledge, the register address will be incremented by one after each acknowledge and the slave will continue to send the data for the updated addressed register.
- If master sends no acknowledge, the slave will stop sending the data.
- Master generate stop condition to finish the read cycle.

I²C Register Map

Table 2 summarizes the device I²C registers, their read/write access and default values. The I²C registers can be reset to their default values by VIN power-on-reset, or by I²C software reset.

Table 2. I²C Register Map

Register Name	Address (Hex)	Read/Write	Default Value
Enable Register	0x01	Read/Write	0x20
Configuration Register	0x02	Read/Write	0x19
LED Flash Current Register	0x03	Read/Write	0x80
LED Torch Current Register	0x04	Read/Write	0x00
Fault Flag Register	0x05	Read	0x00
Device ID Register	0x06	Read	Reserved

I²C Register Description

The following tables summarize the setting of each I²C register. Reserved bits should be written as '0' and ignored during read.

Table 3. Enable Register (Address 0x01, Read/Write)

Bit 7 Boost Mode	Bit 6 Switching Frequency	Bit 5 Current Limit	Bit 4 LVP Enable	Bit 3 STROBE Pin Trigger	Bit 2 STROBE Pin	Bits [1:0] Mode Setting
0 = Boost Mode (Default) 1 = Pass Mode	0 = 2MHz (Default) 1 = 4MHz	0 = 1.9A 1 = 2.8A (Default)	0 = Disable (Default) 1 = Enable	0 = Level (Default) 1 = Edge	0 = Disable (Default) 1 = Enable	00 = Standby (Default) 01 = IR Mode 10 = Torch Mode 11 = Flash Mode

Note: Adjusting STROBE Level/Edge trigger setting while turning on/off flash mode using STROBE pin is not recommended. There is no timing limit for STROBE pulse width to turn on/off the flash mode.

Table 4. Configuration Register (Address 0x02, Read/Write)

Bits [7:5] LVP Voltage Threshold	Bits [4:1] Flash Time-out Duration	Bit [0] Torch Ramp Time
000 = 2.9V (Default) 001 = 3.0V 010 = 3.1V 011 = 3.2V 100 = 3.3V 101 = 3.4V 110 = 3.5V 111 = 3.6V	0000 = 40ms 0001 = 80ms 0010 = 120ms 0011 = 160ms 0100 = 200ms 0101 = 240ms 0110 = 280ms 0111 = 320ms 1000 = 360ms 1001 = 400ms 1010 = 600ms 1011 = 800ms 1100 = 1000ms (Default) 1101 = 1200ms 1110 = 1400ms 1111 = 1600ms	0 = No Ramp 1 = 1ms (default)

Note: May trigger thermal shutdown if the value greater than 500ms under low VIN and small PCB room.

Table 5. LED Flash Current Register (Address 0x03, Read/Write)

Bit [7]	Bits [6:0] LED Flash Current Code
RSVD	$I_{FLASH} (mA) = (Code + 1) \times 1500 / 128 (mA)$ 0000000 = 11.72mA (Default) 0000001 = 23.44mA 0111111 = 750mA 1000000 = 761.72mA 1111111 = 1500mA

Table 6. LED Torch Current Register (Address 0x04, Read/Write)

Bit 7	Bits [6:0] LED Torch Current Code
RSVD	$I_{TORCH} (mA) = (Code + 1) \times 376mA / 128$ 0000000 = 2.94mA (Default) 0000001 = 5.86mA 0111111 = 188mA 1000000 = 191mA 1111111 = 376mA

Table 7. Fault Flag Register (Address 0x05, Read Only)

Bit 7 OVP	Bit 6 LVP	Bit 5 LED Short	Bit 4 Current Limit	Bit 3	Bit 2 Thermal Shutdown (TSD)	Bit 1 UVLO	Bit 0 Flash Time-Out
0 = Normal 1 = OVP	0 = Normal 1 = LVP	0 = Normal 1 = LED Short	0 = Normal 1 = Current Limit	RSVD	0 = Normal 1 = Thermal Shutdown	0 = Normal 1 = UVLO	0 = Normal 1 = Flash Time-out

Table 8. Device ID Register (Address 0x06, Read and Write bit 7 = 1 to Reset)

Bit 7 Software Reset	Bit 6	Bits [5:3] Device ID	Bits [2:0] Revision
0 = Don't Reset (Default) 1 = Reset	RSVD	001	RSVD

Inductor Selection

KTD2690 is designed to use a 0.47µH to 1.0µH inductor. To prevent core saturation, ensure that the inductor saturation current rating exceeds the peak inductor current for the application. The worst-case peak inductor current can be calculated with the following formula:

$$I_{Peak(L)} = \frac{V_{OUT(MAX)} \times I_{LED(MAX)}}{\eta \times V_{IN(MIN)}} + \frac{V_{IN(MIN)} \times t_{ON(MAX)}}{2 \times L}$$

where η is the estimated efficiency.

For example, for a 1.0A LED current application, the peak inductor current for a 1.0µH inductor could be as high as (estimated 25% as the maximum duty ratio at 2MHz, efficiency of 80%, minimum input voltage of 3.5V, 4.0V of output voltage, and maximum load current conditions):

$$I_{Peak(L)} = \frac{4.0V \times 1.0A}{0.8 \times 3.5V} + \frac{3.5V \times 0.125\mu s}{2 \times 1\mu H} = 1.65A$$

If the inductor value is smaller, the inductor peak current will increase. To maintain stable operation for the boost converter, the inductor peak current must be less than both the current limit threshold and the inductor saturation current rating. Manufacturer's specifications of inductors list both the inductor DC current rating, which is a thermal limitation, and peak inductor current rating, which is determined by the saturation characteristics.

Measurements at full load and high ambient temperature should be performed to ensure that the inductor does not saturate or overheat due to its parasitic resistance. Bench measurements are recommended to confirm actual inductor peak current and to ensure that the inductor does not saturate at maximum LED current and minimum input supply voltage.

Table 8. Recommended Inductor

Inductor Part Number	Value (μH)	DCR (mΩ)	Saturation Current (A)	Dimensions (mm)	Manufacturer
MDMK3030T1R0MM	1.0	43	4.3	3 x 3 x 1.2	Taiyo Yuden

Capacitor Selection

For good voltage filtering, low ESR ceramic capacitors are recommended. A 10-μF input capacitor is recommended for high current flash LEDs to improve transient behavior of the regulator and EMI behavior of the total power supply circuit. The input capacitor should be placed as close as possible to the VIN pin and the GND pin. The output capacitance required depends on the required LED current. A 10-μF low ESR ceramic output capacitor is recommended to minimize output voltage ripple, it should also be placed as close as possible to the VOUT pin and the GND pin.

Table 9. Recommended Ceramic Capacitor Vendors

Manufacturer	Website
Murata	www.murata.com
AVX	www.avx.com
Taiyo Yuden	www.t-yuden.com

PC Board Layout

Due to the fast switching operation and high-current paths, careful PC board layout is required. The input and output bypass capacitors should be placed as close to the IC as possible, these two capacitors ground should be placed together and close to the IC GND pin. Minimize the trace length between the IC and the inductor, and keep the trace short, direct, and wide.

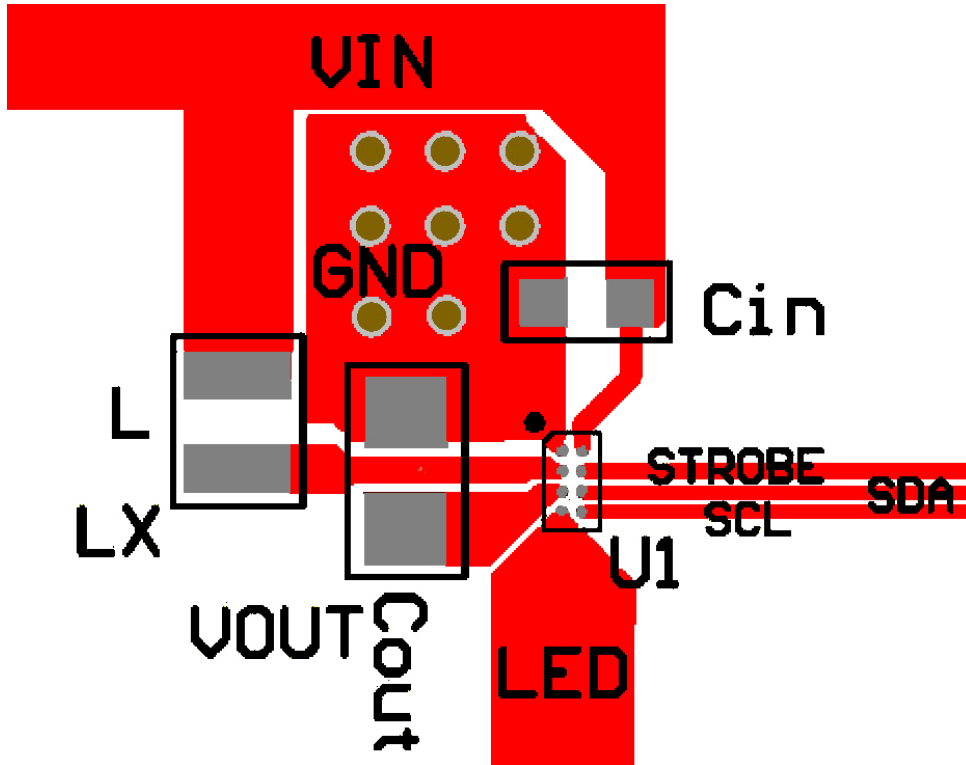

Figure 8. WLCSP Recommended PCB Layout

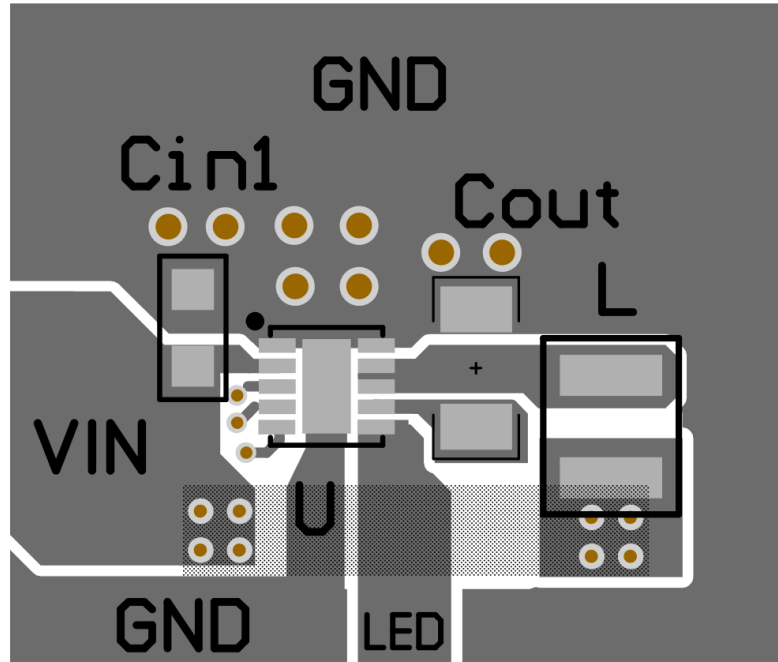
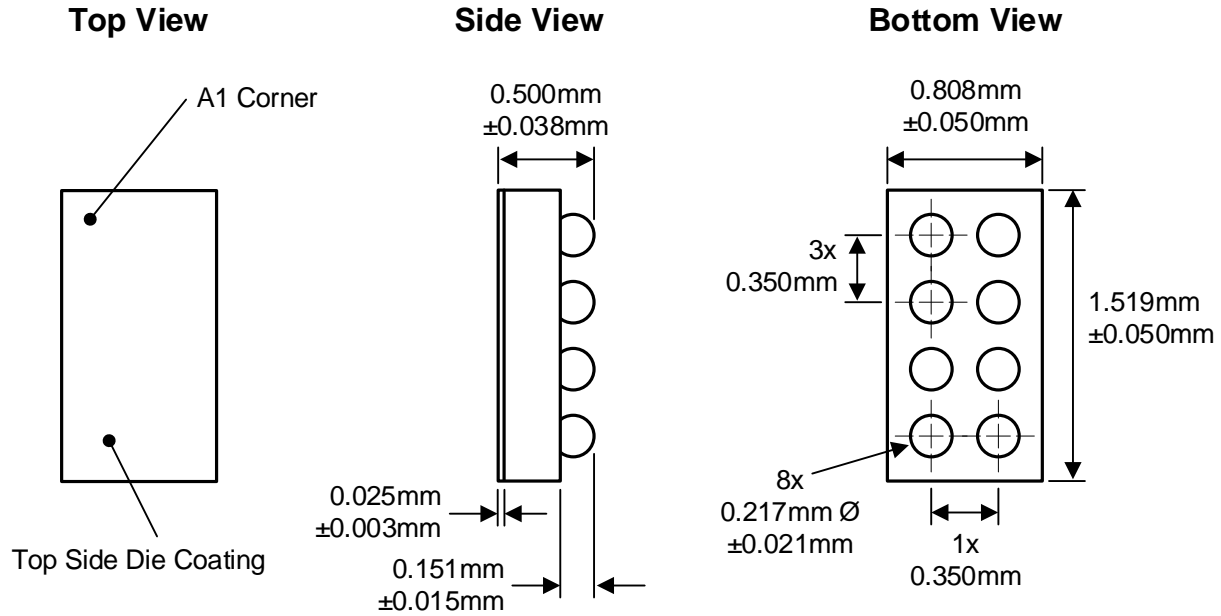

Figure 9. UDFN Recommended PCB Layout

Packaging Information

WLCSP24-8 (0.808mm x 1.519mm x 0.500mm)



Recommended Footprint

(NSMD Pad Type)

