

## 2.0A Slew Rate Controlled Load Switch with Reverse Blocking

### Features

- Operating Range: 1.5V~5.5V
- Low  $R_{DS(ON)}$  MOSFET: Typ. 24m $\Omega$  @ 3.3V
- Continuous DC current up to 2.0A
- Built-in slew rate controlled turn-on: 2.7ms
- Low quiescent current < 1 $\mu$ A
- ESD Protection
  - Human Body Model : 8kV
  - Charged Device Model : >2.0kV
  - Compliance to IEC61000-4-2 level 4
    - Contact Discharge : 8kV
    - Air Discharge : 15kV
- Pb-Free Packages:
  - WLCSP-4, 1.0 x 1.0mm
  - RoHS and Green Compliant
- -40°C to +85°C Temperature Range

### Brief Description

The KTS1601 is slew rate controlled load switch designed for 1.5 V to 5.5 V operation. It features a controlled soft-on slew rate of typical 2.7ms that limits the inrush current for designs with heavy capacitive loads and thereby minimizing any resulting voltage droop at the power rails.

The very low  $R_{DS(ON)}$  allows currents up to 2.0A, whilst minimizing the power dissipation and voltage drop from supply to load. The KTS1601 features an active high enable pin, which is capable of interfacing directly with low input control signals, without any additional level shifting circuitry. The KTS1601 also includes an active pull-down option to ensure the device remains off, should the enable be allowed to float.

The KTS1601 provides reverse blocking in the OFF state to ensure that power supplies are not discharged.

The KTS1601 is available in an optimized, lead-free, fully green compliant, small 4-pin WLCSP 1.0 x 1.0mm package with 0.5mm pitch

### Applications

- Mobile Phones & Tablets
- SSD (Solid State Drive)
- Portable Instruments
- DSC, DVR, GPS

### Typical Application

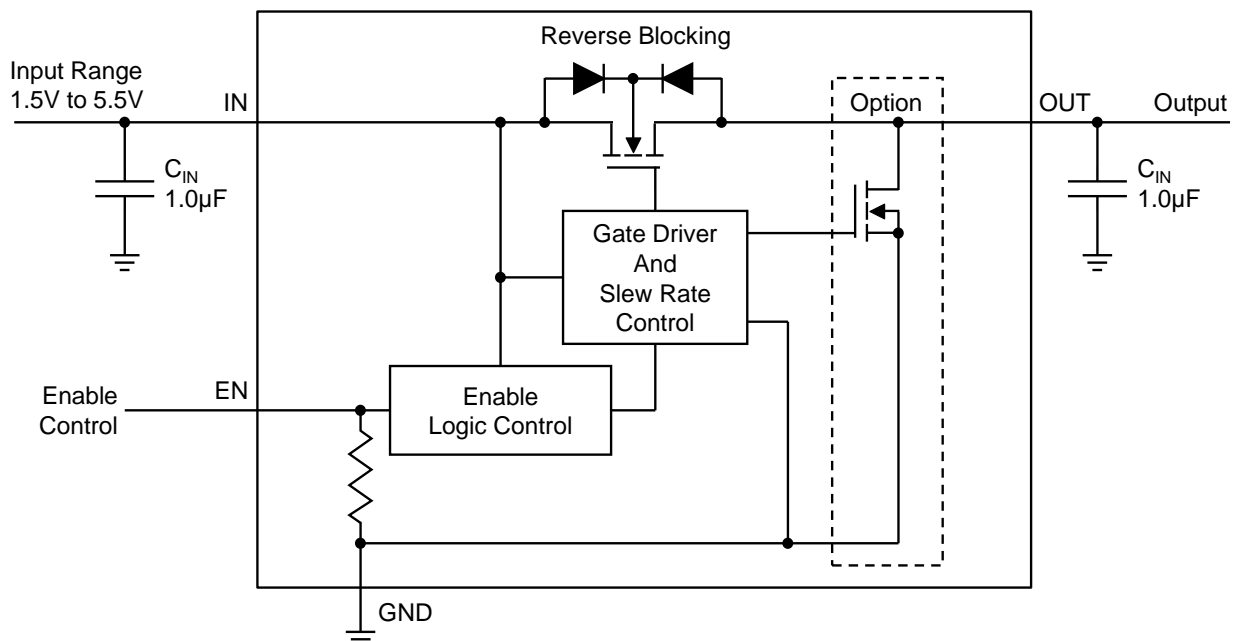

## Pin Descriptions

Pin #	Name	Function
A1	OUT	Power-switch output. Connect a 1.0uF ceramic capacitor from OUT to GND as close as possible to the IC is recommended. As an option, a pull-down transistor can be added to OUT
A2	IN	Power-switch input voltage. Connect a 1.0µF or greater ceramic capacitor from IN to GND as close as possible to the IC.
B1	GND	Ground connection
B2	EN	Enable input, logic high turns on power switch.

### WLCSP-4, 1.0 x 1.0 x 0.625 mm

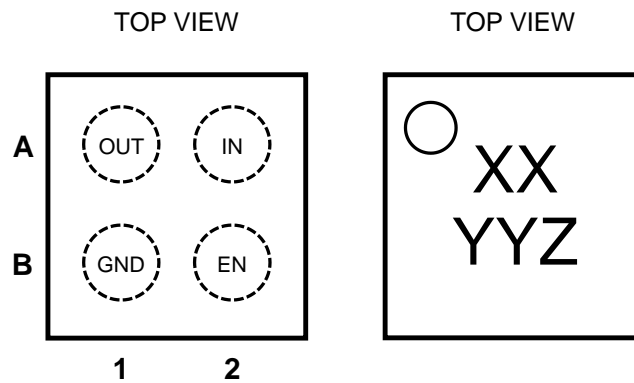

4-Bump 1.0mm x 1.0mm x 0.6mm micro SMD Package

(Top Mark)  
 XX = Device Code  
 YY = Date Code, Z = Assembly Code

## Absolute Maximum Ratings<sup>1</sup>

(T<sub>A</sub> = 25°C unless otherwise noted)

Symbol	Description	Value	Units
IN, OUT, EN	Input voltage, Enable Input Voltage, Output Voltage to GND	-0.3 to +6.0	V
ISW	Maximum Continuous Switch Current (I <sub>MAX</sub> ) <sup>2</sup>	2.0	A
ESD IEC	ESD Withstand Voltage (IEC 61000-4-2) <sup>3</sup> (IN and OUT when bypassed with 1.0µF capacitor minimum)	Air: 8 Contact: 15	kV
ESD HBM	Human Body Model (HBM) ESD Rating <sup>4,5</sup>	8	kV
ESD CDM	Charge Device Model (CDM) Rating <sup>3,4</sup>	2.0	
ESD MM	Machine Model (MM) ESD Rating <sup>3,4</sup>	400	V
T <sub>J</sub>	Operating Junction Temperature Range	-40 to 150	°C
T <sub>s</sub>	Storage Temperature Range	-65 to 150	
T <sub>LEAD</sub>	Maximum Soldering Temperature (at leads, 10sec)	300	
MSL	Moisture Sensitivity <sup>6</sup>	Level 1	

## Thermal Capabilities<sup>7</sup>

Symbol	Description	Value	Units
θ <sub>JA</sub>	Thermal Resistance – Junction to Ambient	100	°C/W
P <sub>D</sub>	Maximum Power Dissipation at T <sub>A</sub> ≤ 25°C	1.25	W
ΔP <sub>D</sub> /°C	Derating Factor Above T <sub>A</sub> = 25°C	-10	mW/°C

## Ordering Information

Part Number	Marking <sup>8</sup>	Operating Temperature	OUT Pull-Down	Package
KTS1601EUM-TR <sup>9</sup>	KKYYZ	-40°C to +85°C	NO	WLCSP-4, 1.0 x 1.0 x 0.625 mm
KTS1601EUM-1-TR	JMYYZ		YES	

- Stresses above those listed in Absolute Maximum Ratings may cause permanent damage to the device. Functional operation at conditions other than the operating conditions specified is not implied. Only one Absolute Maximum rating should be applied at any one time.
- Limited by design
- Guaranteed by design.
- According to JEDEC standard JESD22-A108
- This device series contains ESD protection and passes the following tests:  
Human Body Model (HBM) ±8.0 kV per JEDEC standard: JESD22-A114 for all pins.  
Machine Model (MM) ±400 V per JEDEC standard: JESD22-A115 for all pins.
- Moisture Sensitivity Level (MSL): 1 per IPC/JEDEC standard: J-STD-020.
- Junction to Ambient thermal resistance is highly dependent on PCB layout. Values are based on thermal properties of the device when soldered to a PCB board.
- “YYZ” is the date code and assembly code.
- Contact sales for availability

## Electrical Characteristics<sup>10</sup>

The *Min* and *Max* specs are applied over the full operation temperature range of -40°C to +85°C,  $V_{IN} = 1.5V$  to  $5.5V$  unless otherwise noted, while *Typ* values are specified at  $V_{IN} = 4.5V$  and room temperature ( $T_A = 25^\circ C$ ) unless otherwise noted.

Symbol	Description	Conditions	Min	Typ	Max	Units
$V_{IN}$	Input Voltage Range		1.5		5.5	V
$I_Q$	Quiescent Current	$V_{IN} = 1.5V$ to $5.5V$ , EN = Active, $I_{OUT} = 0mA$			14	$\mu A$
$I_{Q\_OFF}$	No Load Quiescent Current	$V_{IN} = 1.5V$ to $5.5V$ , EN = Inactive, OUT = OPEN			1.0	$\mu A$
$I_{SD}$	Shutdown Current	$V_{IN} = 1.5V$ to $5.5V$ , EN = GND, OUT = GND, $T_A = -40^\circ C$ to $+85^\circ C$			4.0	$\mu A$
$I_{EN\_LEAK}$	EN Input Leakage Current	$V_{EN} = 5.5V$ , $V_{IN} = 0V$	-10		10	$\mu A$
		$V_{EN} = 0V$ , $V_{IN} = 5.5V$	-1.0		1.0	
$R_{DS(ON)}$	On-Resistance	$V_{IN} = 5.5V$ , $I_{OUT} = 1A$ , $T_A = 25^\circ C$		19		$m\Omega$
		$V_{IN} = 4.5V$ , $I_{OUT} = 1A$ , $T_A = 25^\circ C$		20		$m\Omega$
		$V_{IN} = 3.3V$ , $I_{OUT} = 500mA$ , $T_A = 25^\circ C$		24	30	$m\Omega$
		$V_{IN} = 2.7V$ , $I_{OUT} = 500mA$ , $T_A = 25^\circ C$		27		$m\Omega$
		$V_{IN} = 1.5V$ , $I_{OUT} = 500mA$ , $T_A = 25^\circ C$		49		$m\Omega$
$V_{IH}$	EN Input Logic High Level	$V_{IN} = 1.5V$ to $5.5V$	1.15			V
$V_{IL}$	EN Input Logic Low Level	$V_{IN} = 1.8V$ to $5.5V$			0.65	V
		$V_{IN} = 1.5V$ to $1.8V$			0.60	
$R_{EN\_DOWN}$	EN Pull-down Resistor	$V_{IN} = V_{EN} = 1.5V$ to $5.5V$ , $T_A = -40^\circ C$ to $+85^\circ C$	6.38	7.65	8.86	$M\Omega$
$R_{OUT\_PD}$	OUT Pull-down Transistor (-1) Only	$V_{EN} = 0V$ , $I_{OUT} = 20mA$		50		$\Omega$
$I_{OUT\_OUT}$	VOOUT Shutdown Current	$V_{EN} = 0V$ , $V_{OUT} = 4.2V$ , $V_{IN} = \text{Short to GND}$			1.0	$\mu A$
$t_{DELAY\_ON}$	Turn-On Delay Time <sup>11,12</sup>	$V_{IN} = 4.5V$ , $R_{LOAD} = 5\Omega$ , $C_{LOAD} = 100\mu F$ , $T_A = 25^\circ C$		1.7		ms
$t_R$	$V_{OUT}$ Rise Time <sup>9,10</sup>			2.7		
$t_{ON}$	Turn-On Time <sup>9,10</sup>			4.4		
$t_{DELAY\_ON}$	Turn-On Delay Time <sup>9,10</sup>	$V_{IN} = 4.5V$ , $R_{LOAD} = 150\Omega$ , $C_{LOAD} = 100\mu F$ , $T_A = 25^\circ C$		1.7		ms
$t_R$	$V_{OUT}$ Rise Time <sup>9,10</sup>			1.5		
$t_{ON}$	Turn-On Time <sup>9,10</sup>			3.2		
$t_{DELAY\_OFF}$	Turn-Off Delay Time <sup>9,13</sup>	$V = 4.5V$ , $R_{LOAD} = 150\Omega$ , $C_{LOAD} = 100\mu F$ , $T_A = 25^\circ C$		1.8		ms
$t_F$	$V_{OUT}$ Fall Time <sup>9,11</sup>			34		
$t_{OFF}$	Turn-Off Time <sup>9,11</sup>			35		

10. All specifications are 100% production tested at  $T_A = +25^\circ C$ , unless otherwise noted. Specifications are over -40°C to +85°C and are guaranteed by design

11.  $t_{DELAY\_ON}/t_{DELAY\_OFF}/t_R/t_F$  are defined in Figure 1

12.  $t_{ON} = t_R + t_{DELAY\_ON}$

13.  $t_{OFF} = t_F + t_{DELAY\_OFF}$

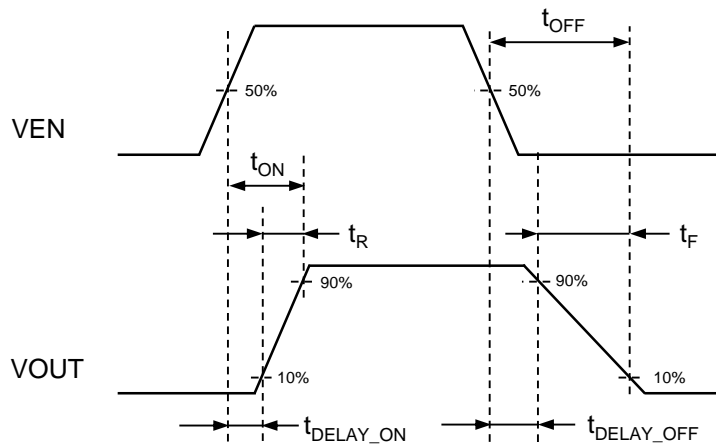
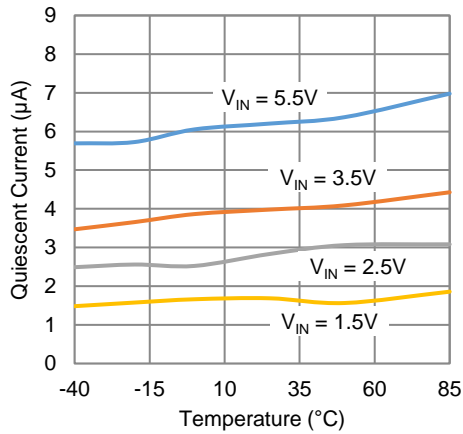

Figure 1. Timing Diagram

## Typical Characteristics

$V_{IN} = 5V$ ,  $C_{IN} = 0.1\mu F$ ,  $C_{OUT} = 1\mu F$ , Temp =  $25^{\circ}C$  unless otherwise specified.

Quiescent Current vs. Temperature



Quiescent Current vs. Supply Voltage

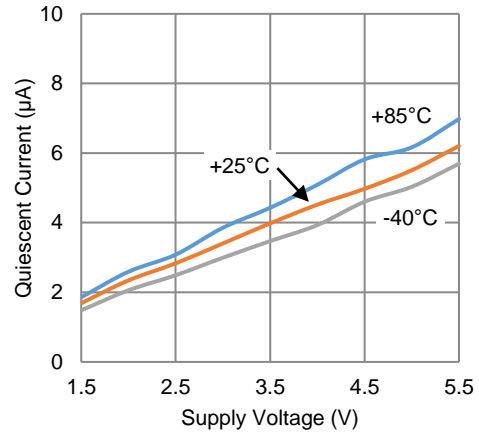

Shutdown Current vs. Temperature

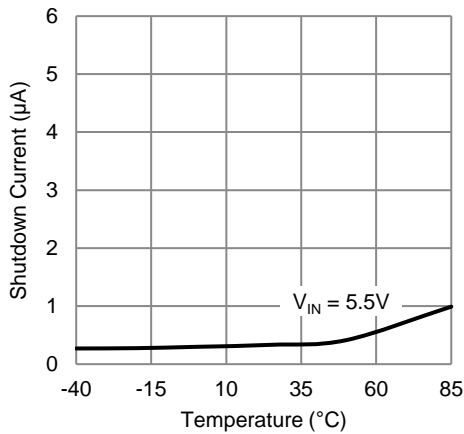

Shutdown Current vs. Supply Voltage

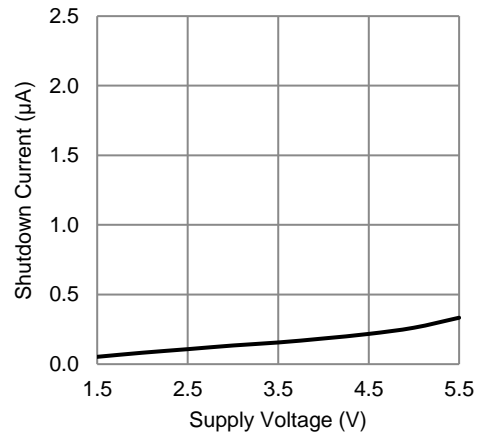

On Resistance vs. Supply Voltage ( $I_{OUT} = 500mA$ )

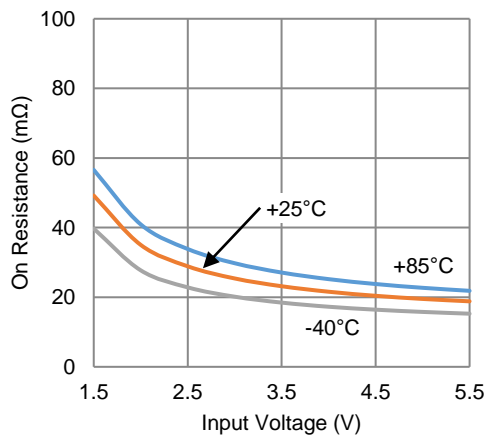

On Resistance vs. Temperature ( $I_{OUT} = 500mA$ )

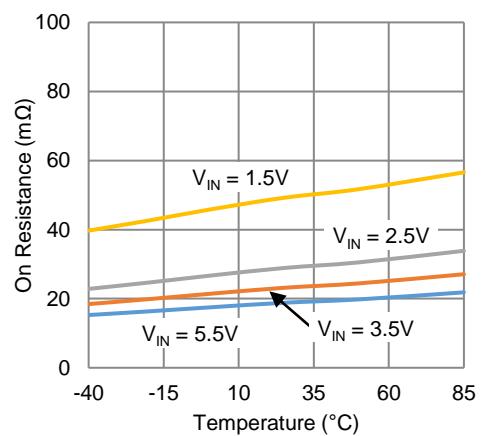

## Typical Characteristics (continued)

$V_{IN} = 5V$ ,  $C_{IN} = 0.1\mu F$ ,  $C_{OUT} = 1\mu F$ , Temp = 25°C unless otherwise specified.

EN Pin Threshold vs. Supply Voltage

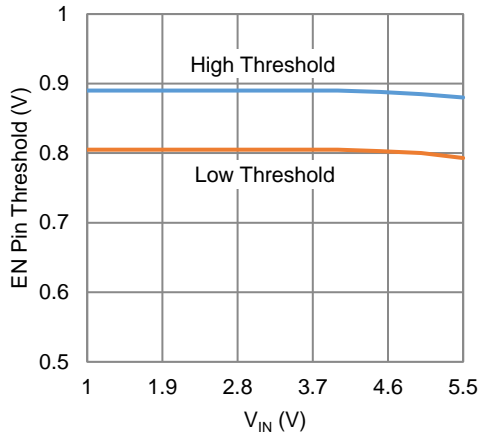

Turn-On & Turn-Off Response  
( $V_{IN} = 4.5V$ ,  $C_{IN} = 10\mu F$ ,  $C_{OUT} = 100\mu F$ ,  $R_L = 5\Omega$ )

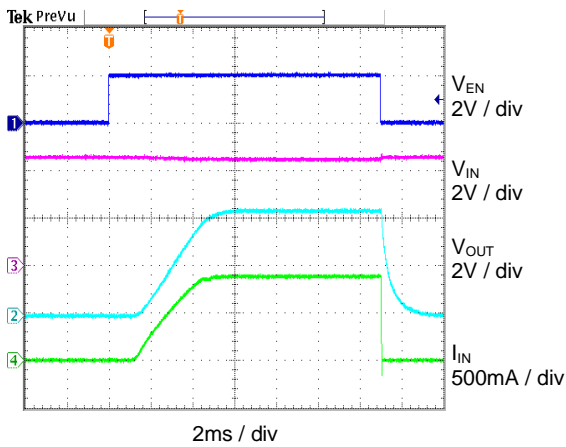

In-rush Current Waveform  
( $V_{IN} = 5.0V$ ,  $C_{IN} = 10\mu F$ ,  $C_{OUT} = 100\mu F$ ,  $R_L = \text{Open}$ )

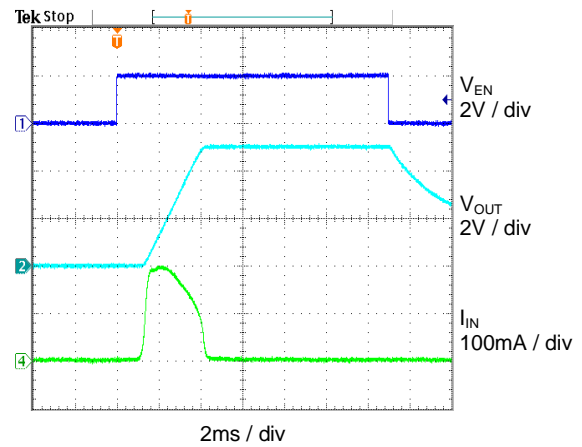

Turn-On Response  
( $V_{IN} = 4.5V$ ,  $C_{OUT} = 100\mu F$ ,  $R_L = 150\Omega$ )

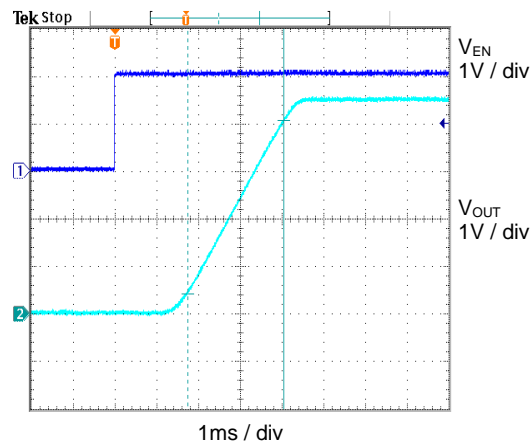

Turn-Off Response  
( $V_{IN} = 4.5V$ ,  $C_{OUT} = 100\mu F$ ,  $R_L = 150\Omega$ )

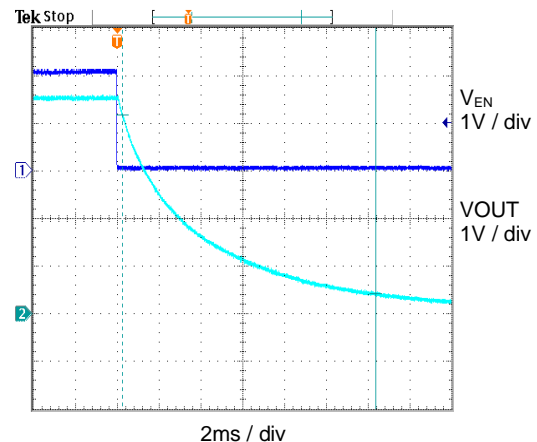

## Functional Block Diagram

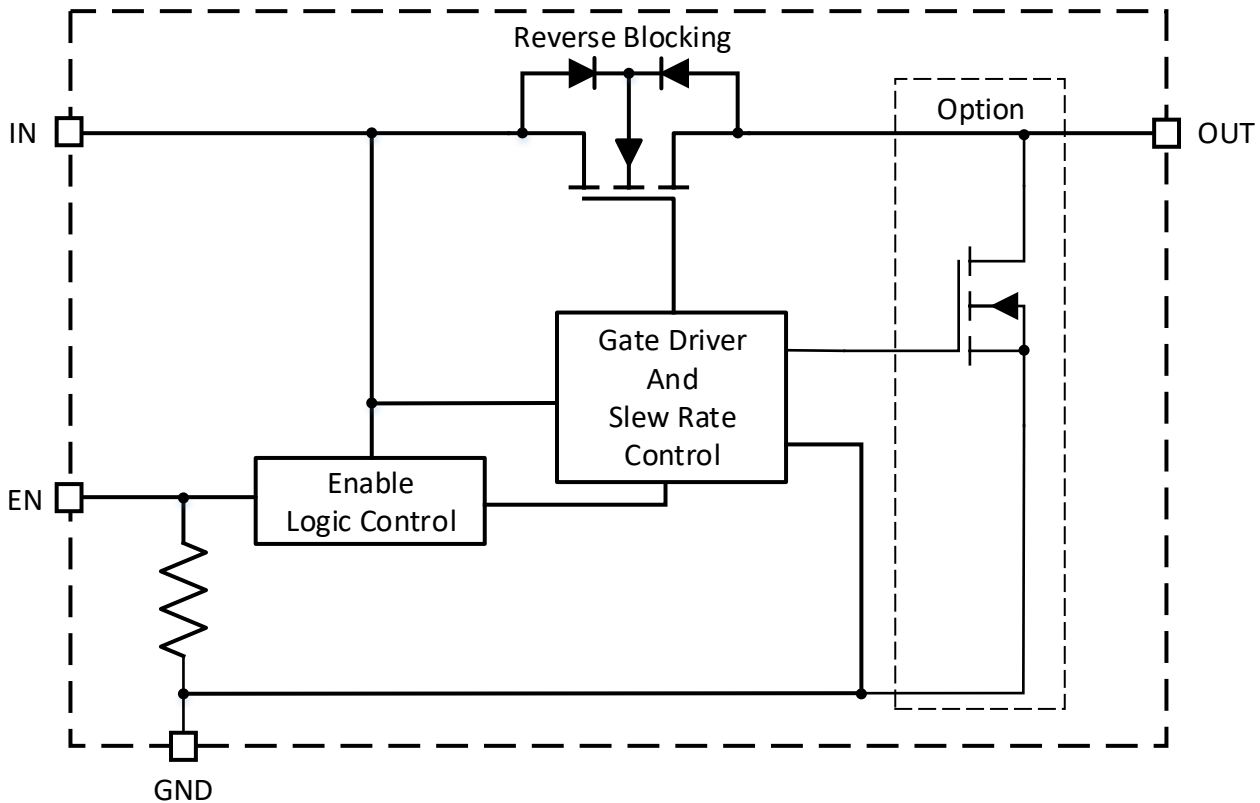

## Functional Description

The KTS1601 is an advanced slew-rate controlled high-side load switch comprised of a low resistance MOSFET power switch, level shift with slew-rate control logic and reverse blocking protection. The KTS1601 is a low resistance MOSFET power distribution switch designed to connect an external voltage, such as a DC power supply or battery, directly to the system. The high-side MOSFET is turned-on sequence is initiated via an active high, low voltage logic voltage signal. Once above the input threshold voltage, the MOSFET turn-on is slew-rate limited to avoid excessive current surges, due to high capacitance loads. By limiting the turn-on, large voltage over-shoot can also be avoided. Once fully on the MOSFET will provide a low resistance path to the load, both minimizing the voltage drop from IN to OUT, while keeping the power dissipation to a minimum.

Should the voltage on the output of The KTS1601 switch, in the OFF state, be higher than the input voltage, Reverse Blocking circuitry will be activated to stem the flow of current preventing power supplies for discharging.

The KTS1601 integrates a pull-down resistor on the enable pin to ensure that the device should remain OFF when the EN is left floating.

An option of the KTS1601 adds an active pull-down (discharge) transistor between OUT and GND to discharge any voltage stored in the output capacitors to GND.



## Application Information

### Enable Input

The EN pin is compatible with active HIGH GPIO and CMOS logic voltage levels and operates over the 1.5V to 5.5V operating voltage range. The KTS1601 incorporates an internal pull-down resistor on the enable pin, to ensure that the device remains OFF, in the event that the pin is left floating.

### Reverse Current Blocking

The KTS1601 implements reverse current blocking circuitry, to prevent reverse current flow through the switch. The reverse current blocking circuitry is active when the device is in the OFF state.

### Input Capacitor

To limit the voltage drop on the input supply caused by transient inrush currents, an input bypass capacitor is recommended. A minimum capacitance of 1.0µF, must be placed as close as possible between pins VIN and GND) to be Compliant with IEC 61000-4-2 (Level 4).

Higher value capacitors can further help to reduce the voltage drop. Ceramic capacitors are recommended for their ability to withstand input current surges from low impedance sources such as batteries in portable devices.

### Output Capacitor

Depending on the sink current during system start-up and system turn-off, a capacitor must be placed on the output. A 1.0µF or larger capacitor across OUT and GND pins is recommended to accommodate load transient condition. This capacitor can also help to prevent parasitic inductance which can force the output voltage to fall below GND during turn-off. The output capacitor has minimal effect on The KTS1601's turn-on slew-rate time. There is no requirement on capacitor type or it's ESR.

### Inrush Current

Inrush current occurs when the device is turned on. Inrush current is dependent on output capacitance and slew-rate control capability, as expressed by:

$$I_{INRUSH} = C_{OUT} \times \frac{V_{IN} - V_{INITIAL}}{t_R} + I_{LOAD}$$

Where:

$C_{OUT}$  - Output capacitance

$t_R$  - Slew-rate or rise time at  $V_{OUT}$

$V_{IN}$  - Input voltage

$V_{INITIAL}$  - Initial voltage at  $C_{OUT}$ , usually GND

$I_{LOAD}$  - Load current

Higher inrush current causes higher input voltage drop, depending on the distributed input resistance and input capacitance. High inrush current can cause problems.

The KTS1601 has a 2.7ms of slew-rate capability under 4.5V<sub>IN</sub> at 1000µF of  $C_{OUT}$  and 5Ω of  $R_{LOAD}$  so inrush current can be minimized and no input voltage drop appears.

## Layout Guidelines

The KTS1601 integrates a 2.0A rated MOSFET, and the PCB design rules must be respected to properly transfer the heat out of the silicon. By increasing PCB area, the  $R_{\theta JA}$  of the package can be decreased, allowing higher power dissipation.

For the best performance, all traces should be as short as possible to minimize the inductance and parasitic effects. The input and output capacitors should be kept as close as possible to the input and output pins respectively. Using wide traces for input, output, and GND help reducing the case to ambient thermal impedance.

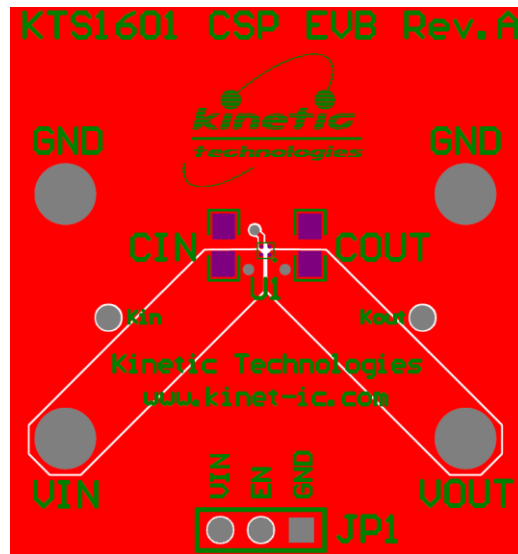

Figure 2. KTS1601 Evaluation Board Layout (TOP Layer)