

Adjustable Over-Voltage Protection Switch

Features

- Wide Input voltage range: 2.7V to 30V
- Up to 3.0A current capability
- Integrated 60mΩ (typ) N-Channel MOSFET
- Fast OVP turn-off response time: 100ns
- Flexible trip-point options
 - ▶ Default Fixed 6.05
 - ▶ Adj. 4V to 20V
- Auto-enabled switch with 18ms debounce time
- Under voltage (UVLO), Short-circuit and thermal shutdown protection
- Compliance to IEC61000-4-2 (level 4)
 - ▶ Contact: ±8kV
 - ▶ Air Gap: ±15kV
- ESD Protection
 - ▶ Human Body Model: ±2.5kV
- Pb-free UDFN-8 package and WLCSP-6 packages
- -40°C to +85°C Temperature Range

Brief Description

The KTS1670 over-voltage protection device features an ultra-low 60mΩ (typical) on-resistance high current integrated MOSFET which actively protects low-voltage systems from voltage supply faults up to +30V.

An input voltage exceeding the over-voltage threshold will cause the internal MOSFET to turn off, preventing excessive voltage from damaging downstream devices.

When the OVLO input is connected to GND, the KTS1670 automatically chooses the internal fixed OVLO threshold, preset to 6.05V (typical). The over-voltage protection threshold can be adjusted with an optional external resistor divider to a voltage between 4V and 20V.

In case the device temperature exceeds the maximum junction temperature, the device switches off.

The KTS1670 is available in a RoHS and Green compliant 8-lead 2.0 x 2.0 x 0.5mm UDFN and 6-Bump 1.20 x 1.00mm WLCSP packages.

Applications

- Smartphones
- Mobile Internet Devices
- Tablet Computers
- Peripherals
- STB

Typical Application

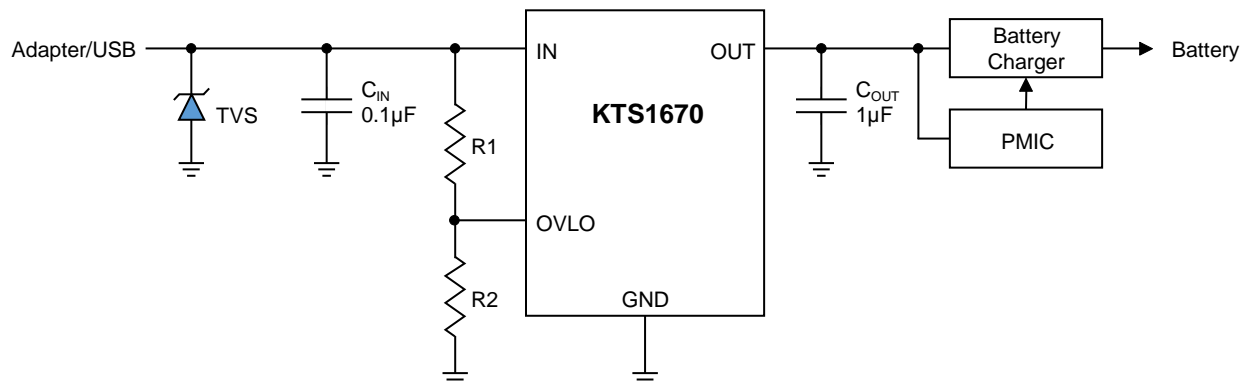

Pin Descriptions

UDFN	WLCSP	Name	Function
5, 6, 7	A2, B2	IN	Voltage Input. Bypass IN with 0.1 μ F capacitor as close as possible to the device.
8	C2	OVLO	External OVLO adjustment. Connect OVLO to GND when using the internal threshold. Connect a resistor-divider to OVLO to set a different OVLO threshold.
1	C1	GND	Ground.
2, 3, 4	A1, B1	OUT	Output Voltage
MC	–	MC	Metal chassis. Connect to ground for electrical and thermal usage. MC is internally connected to Analog Ground pin.

UDFN22-8

TOP VIEW

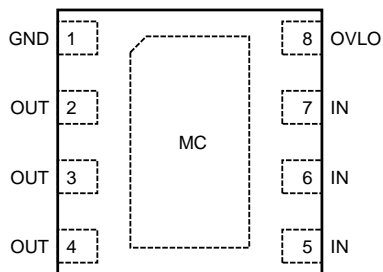

TOP VIEW

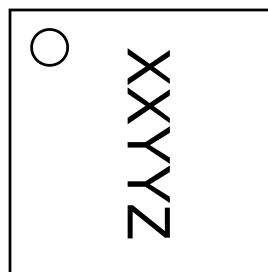

8-Lead 2.00mm x 2.00mm x 0.5mm
UDFN Package

Top Mark

XX = Device Code
YY = Date Code, Z = Assembly Code

WLCSP-6

TOP VIEW

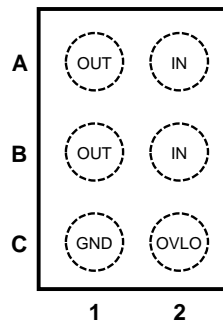

TOP VIEW

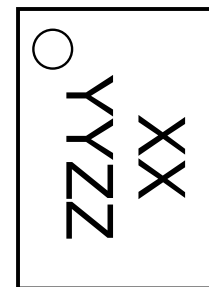

6-Bump 1.20mm x 1.00mm x 0.6mm
WLCSP Package

Top Mark

XX = Device Code
YY = Date Code, ZZ = Assembly Code

Absolute Maximum Ratings¹

(T_A = 25°C unless otherwise noted)

Symbol	Description	Value	Units
IN	Input voltage	-0.3 to 30	V
OUT	Output voltage	-0.3 to VIN+0.3	V
OVLO	OVLO Pin	-0.3 to 7	V
IN, OUT Current	Continuous Current	3.0	A
T _J	Operating Temperature Range	-40 to 150	°C
T _s	Storage Temperature Range	-65 to 150	°C
T _{LEAD}	Maximum Soldering Temperature (at leads, 10 sec)	260	°C

Thermal Capabilities

Symbol	Description	Value	Units
WLCSP-6			
θ _{JA}	Thermal Resistance – Junction to Ambient ²	107	°C/W
P _D	Maximum Power Dissipation at T _A ≤ 25°C	1170	mW
ΔP _D /ΔT	Derating Factor Above T _A = 25°C	-9.4	mW/°C
UDFN22-8			
θ _{JA}	Thermal Resistance – Junction to Ambient ²	90	°C/W
P _D	Maximum Power Dissipation at T _A ≤ 25°C	1380	mW
ΔP _D /ΔT	Derating Factor Above T _A = 25°C	-6.5	mW/°C

Ordering Information

Part Number	Marking ³	Operating Temperature	Package
KTS1670EUN-TR	KEYZZZ	-40°C to +85°C	WLCSP-6
KTS1670EDA-TR	KEYYZ	-40°C to +85°C	UDFN22-8

Recommended Operating Range⁴

Description	Value
Input voltage range	2.7V to 20V
Input to output continuous current	2A
Output capacitance range	Up to 100μF

- Stresses above these ratings may cause permanent damage. Exposure to absolute maximum conditions for extended periods may degrade device reliability. These are stress ratings only, and functional operation of the device at these or any other conditions beyond those specified is not implied.
- Junction to Ambient thermal resistance is highly dependent on PCB layout. Values are based on thermal properties of the device when soldered to an EV board.
- "KEYZZZ" is the device code, date code and assembly code respectively.
- The device is not guaranteed to function outside of recommended operating condition.

Electrical Characteristics⁵

Unless otherwise noted, the *Min* and *Max* specs are applied over the full operation temperature range of -40°C to +85°C, while *Typ* values are specified at room temperature (25°C). $V_{IN} = 5.0V$, $I_{IN} \leq 3A$

Symbol	Description	Conditions	Min	Typ	Max	Units
INPUT Operation						
I_{IN}	Input supply current	$V_{IN} = 5V$, $V_{IN} < V_{IN_OVLO}$			120	μA
V_{IN_UVLO}	Under voltage lockout threshold	V_{IN} rising		2.3		V
V_{UVLO_HYST}	Under voltage lockout hysteresis			0.1		V
OVP						
V_{IN_OVLO}	Internal over voltage trip level	V_{IN} rising		6.05		V
$V_{IN_OVLO_HYS}$	OVLO Hysteresis	V_{IN} falling		0.10		V
V_{OVLO_TH}	OVLO preset threshold range		1.185	1.215	1.245	V
	Adjustable OVLO threshold range		4		20	V
V_{OVLO_SEL}	External OVLO select threshold		0.2		0.3	V
$R_{DS(ON)}$	Switch On-Resistance	$V_{IN} = 5V$, $I_{IN} = 1.0A$, $T_A = +25^\circ C$		60		m Ω
I_{OVLO}	OVLO input leakage current	$V_{OVLO} = V_{OVLO_TH}$	-120		120	nA
TIMING – Figure 1						
t_{DEB}	Debounce time	Time from $2.5V < V_{IN} < V_{IN_OVLO}$ to $V_{OUT} = 10\%$ of V_{IN}		18		ms
t_{ON}	Switch turn-on time	$V_{IN} = 5V$, $R_L = 100\Omega$, $C_{LOAD} = 100\mu F$ V_{OUT} from 10%, V_{IN} to 90% V_{IN}		2		ms
t_{OFF}	Switch turn-off time	$V_{IN} > V_{IN_OVLO}$ to V_{OUT} stop rising		100		ns
ESD PROTECTION						
V_{ESD}	IEC61000-4-2 Contact discharge	IN and OUT pins. $C_{IN} = C_{OUT} = 1\mu F$		± 8		kV
	IEC61000-4-2 Air gap discharge	IN and OUT pins. $C_{IN} = C_{OUT} = 1\mu F$		± 15		kV
All pins	Human Body Model(HBM) Model = 2			± 2.5		kV
THERMAL SHUTDOWN						
t_{J-TH}	IC junction thermal shutdown threshold			145		$^\circ C$
	IC junction thermal shutdown hysteresis			20		$^\circ C$

5. KTS1670 is guaranteed to meet performance specifications over the -40°C to +85°C operating temperature range by design, characterization and correlation with statistical process controls.

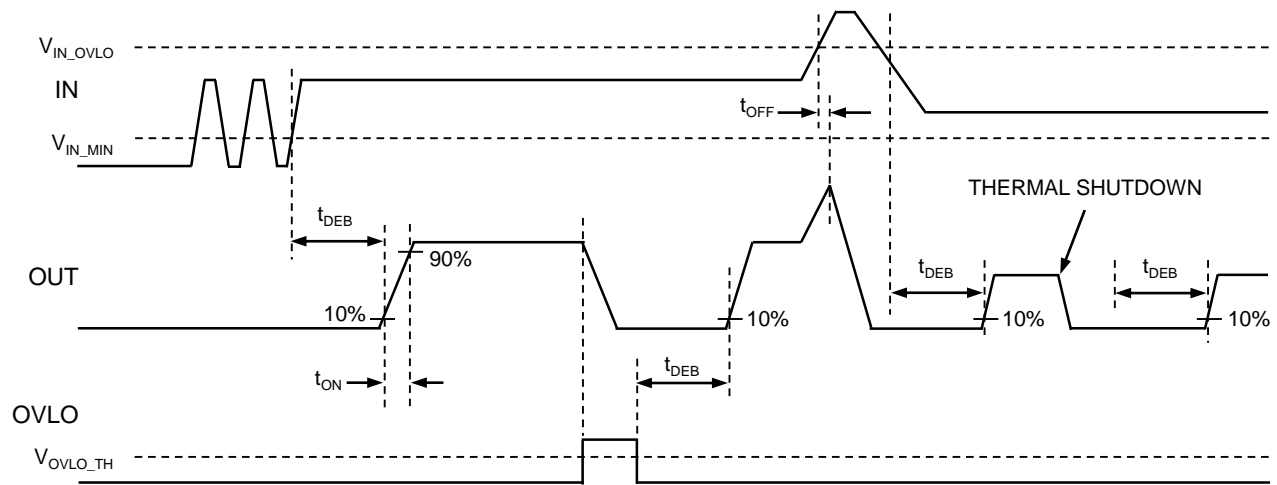

* NOTE: WAVEFORMS ARE NOT TO SCALE

Figure 1. Timing Diagram

Typical Characteristics

$V_{IN} = 5V$, $C_{IN} = 0.1\mu F$, $C_{OUT} = 1\mu F$, OVLO pin = GND, Temp = 25°C unless otherwise specified.

Normalized $R_{DS,ON}$ vs. Output Current

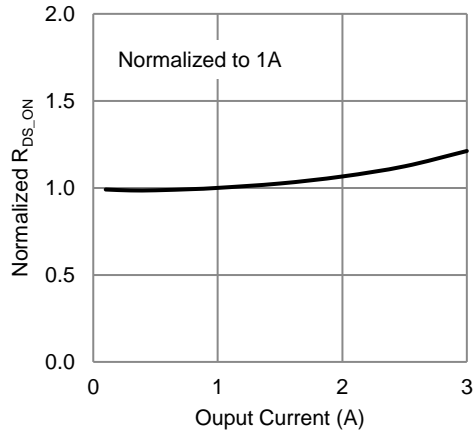

Normalized $R_{DS,ON}$ vs. Temperature

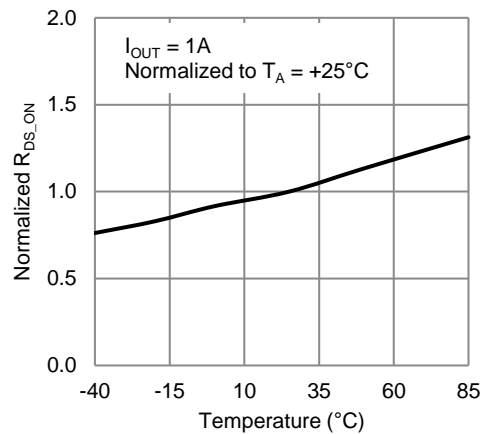

Input Supply Current vs. Input Voltage (no load)

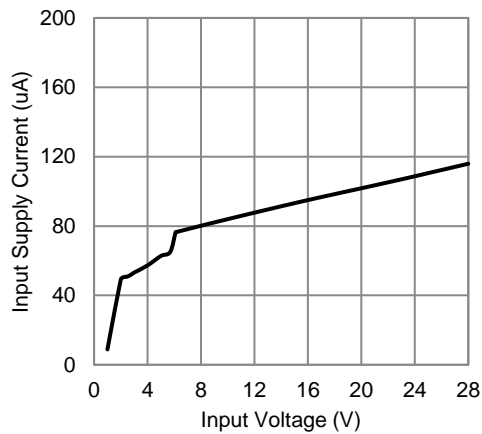

Normalized Debounce Time vs. Temperature

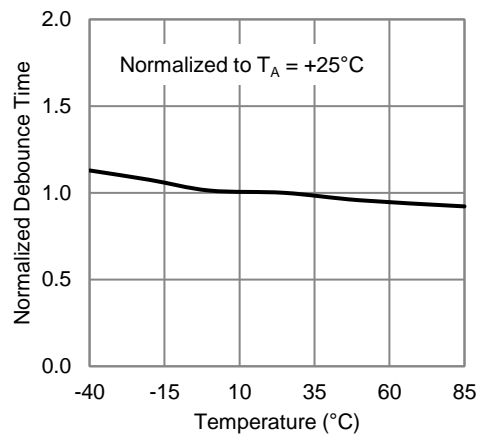

Normalized Fixed OVLO vs. Temperature (OVLO pin GND)

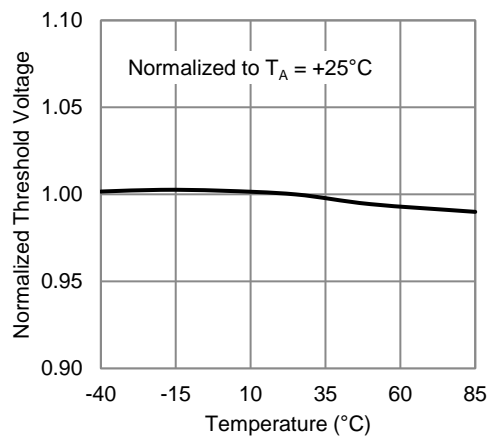

Normalized Adjustable OVLO Threshold vs. Temperature

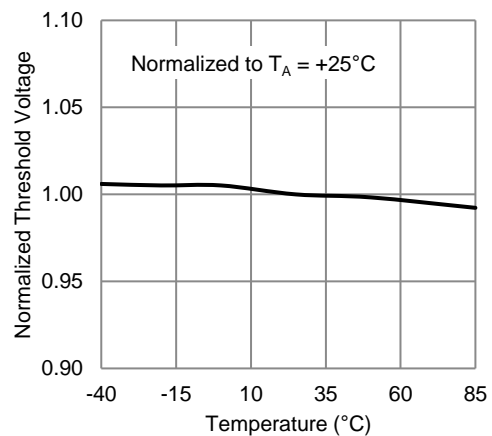

Typical Characteristics (continued)

$V_{IN} = 5V$, $C_{IN} = 0.1\mu F$, $C_{OUT} = 1\mu F$, OVLO pin = GND, Temp = 25°C unless otherwise specified.

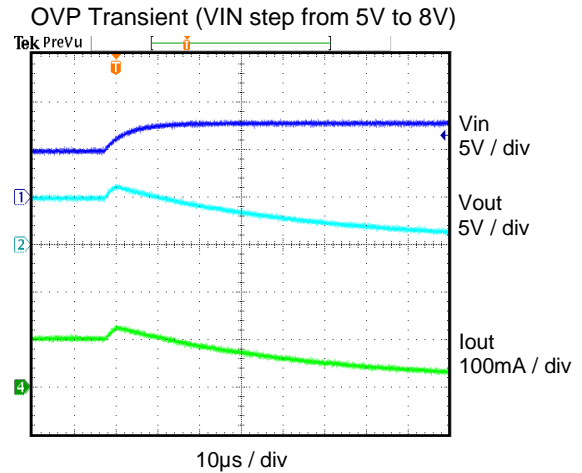
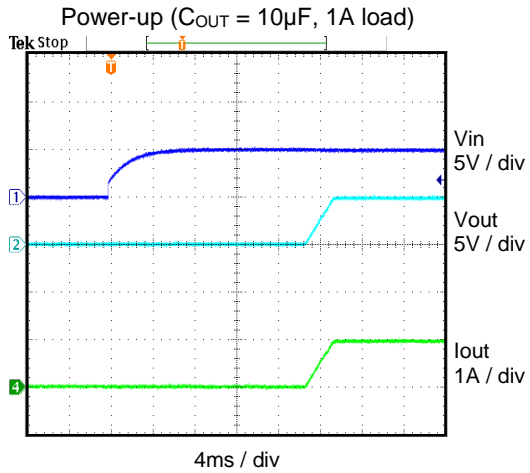

Functional Block Diagram

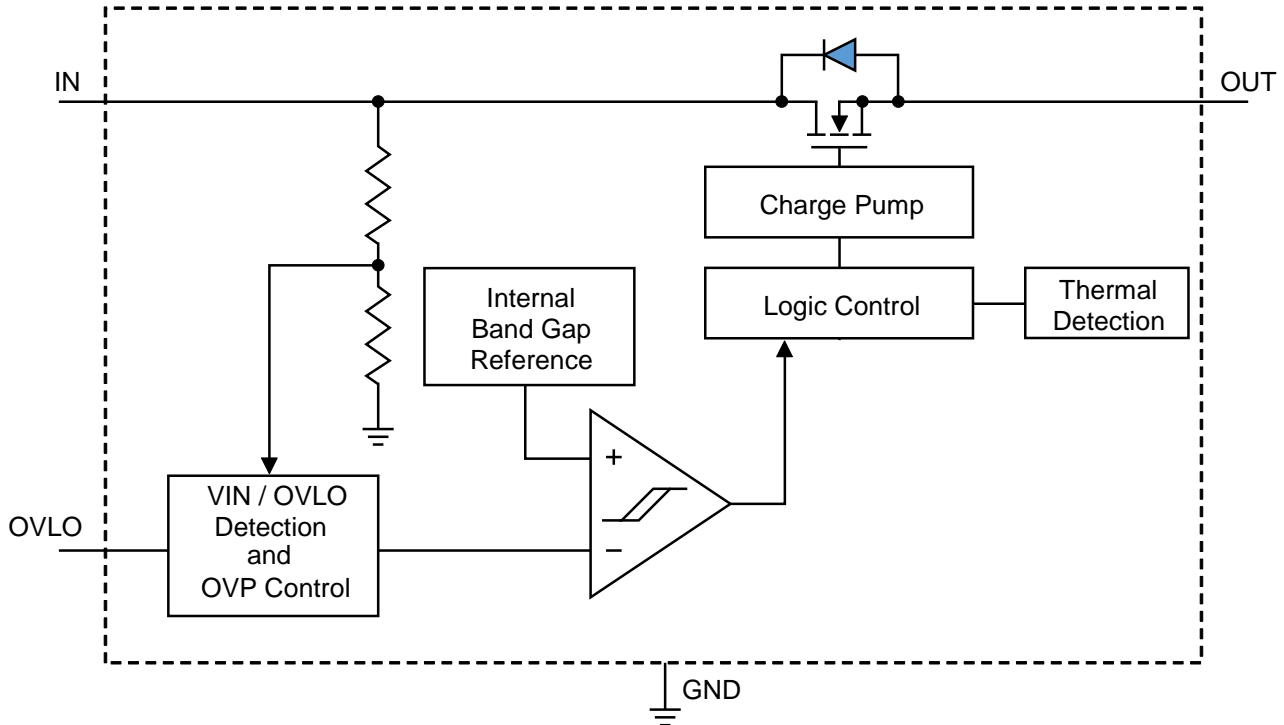

Functional Description

The KTS1670 is inserted between the power supply or charger source and the load to be protected. The KTS1670 consists of a slew-rate controlled, low resistance OVP switch, under-voltage lockout protection (UVLO), and over-voltage monitor and protection (OVLO).

The KTS1670 overvoltage protection device features a low on-resistance ($R_{DS(on)}$) internal FET and protects low-voltage systems against voltage faults up to +30V. If the input voltage exceeds the overvoltage threshold, the internal FET is turned off to prevent damage to upstream components. The 18ms debounce time built into the device prevents false turn on of the internal FET during startup.

In normal operation the OVP switch acts as a slew-rate controlled load switch, connecting and disconnecting the power supply from IN to OUT. A low resistance N-Channel MOSFET is used to minimize the voltage drop between the voltage source and the load and to reduce power dissipation.

When the voltage at the input exceeds the programmed over-voltage trip point, the device immediately turns off the internal switch disconnecting the load from the abnormal voltage, preventing damage to downstream components.

In the event that the power dissipation causes the chip temperature to exceed its maximum temperature setting, the KTS1670 will switch off protecting the device. Once the chip temperature has cooled to below the hysteresis temperature, KTS1670 will re-initiate. Should the over-temperature condition persist, then KTS1670 will continue to thermally cycle on and off, until the input power is removed.

USB ON-The-Go (OTG) Operation

When used in an OTG application the KTS1670 can provide power from OUT to IN. Initially, the OTG voltage applied at OUT will forward bias the power switch bulk diode and present a voltage drop of approximately 0.7V between OUT and IN. The maximum current in this mode is limited by the thermal performance of the device and at an ambient temperature of 25°C

$$I_{MAX} = 1.17W/0.7V = 1.67A$$

This is purely a transitional condition as once the voltage at IN exceeds the UVLO voltage of 2.3V and the debounce time of 18ms has elapsed, the main power switch will turn fully ON, significantly reducing the voltage drop from OUT to IN.

UVLO (Under Voltage Lockout)

The device has a built-in under voltage lock out (UVLO) circuit. When V_{IN} is rising, the output remains disconnected from the input until V_{IN} voltage is above 2.3V (nominal). This circuit has a 100mV hysteresis to provide noise immunity to transient conditions.

OVLO (Over Voltage Lockout)

The KTS1670 adjustable version has a 1.215V (typ) overvoltage trip threshold on the OVP pin. With a resistor divider on OVLO pin from IN to GND, the over-voltage protection point of IN can be adjusted between 4V and 20V. Fixed OVP products are available with an internal resistor divider providing 6.05V(typ), 9.98V (typ), or 13.5V (typ) OVLO threshold trip voltage. To activate the internal Fixed OVP, the OVLO pin should be connected to GND.

Internal MOSFET Switch

The KTS1670 incorporates an internal MOSFET with a 60mΩ (typ) $R_{DS(ON)}$. The MOSFET gate is driven by an integrated charge pump which generates the necessary voltage above IN.

Thermal Protection

The internal FET turns off when the junction temperature exceeds +145°C (typ). The device exits thermal shutdown after the junction temperature cools down by 20°C (typ).

Application Information

Input Capacitor

A 0.1μF or larger capacitor is typically recommended for C_{IN} . C_{IN} should be located close to the device IN pin. Ceramic capacitors are recommended for C_{IN} . Select capacitors with a voltage rating at least 5V higher than the maximum possible voltage during surge. 50V rated capacitors are ideal for most applications.

Output Capacitor

In order to ensure stability while the current limit is active, a small output capacitance of approximately 1μF is required at the output. The output capacitor has no specific capacitor ESR requirement. If desired, C_{OUT} may be increased to accommodate any load transient condition.

External OVLO Adjustment

If OVLO is connected to ground, the internal OVLO comparator uses the internally set OVLO value.

The adjustable threshold uses a 1.215V (typical) overvoltage trip threshold on the OVLO pin. With a resistor divider on the OVLO pin from IN to GND, the over-voltage protection point of IN can be adjusted between 4V and 20V. Once the OVLO pin voltage exceeds the OVLO select voltage, V_{OVLO_SELECT} (0.25V typical), the comparator reads the OVLO pin voltage (a fraction of IN) set by the external resistor divider (R_1 , R_2).

$R_1 = 1M\Omega$ is a good starting value for minimum current consumption. Since V_{IN_OVLO} , V_{OVLO_THRESH} , and R_1 are known, R_2 can be calculated from the following formula:

$$V_{IN_OVLO} = V_{OVLO_TH} \times (1+R_1/R_2) = 1.215V \times (1+R_1/R_2)$$

This external resistor-divider is completely independent from the internal resistor-divider.

Packaging Information

UDFN22-8 (2.00mm x 2.00mm x 0.50mm)

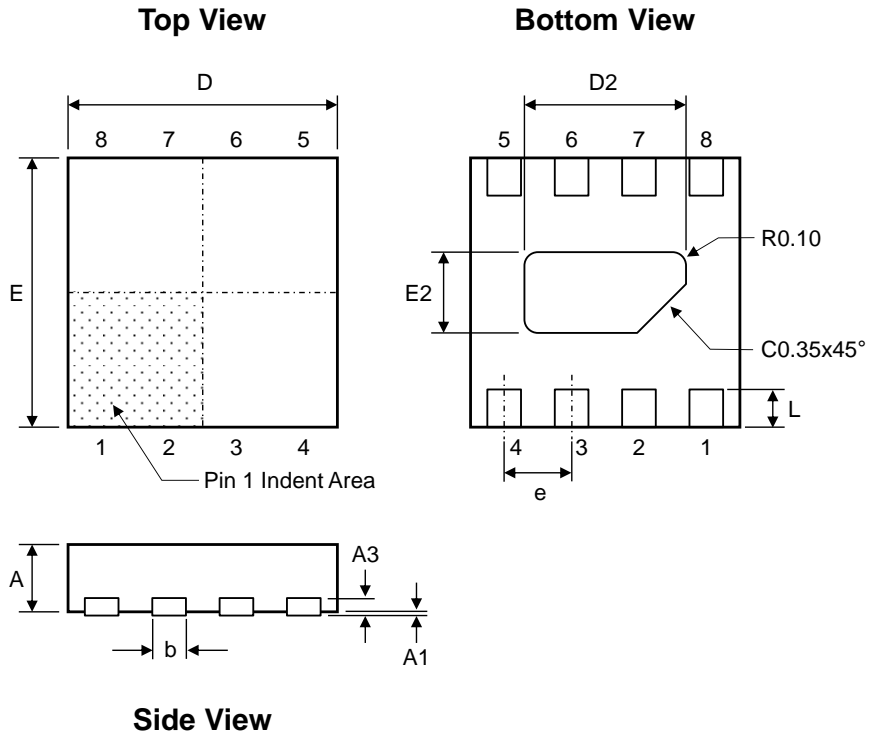

Dimension	mm		
	Min.	Typ.	Max.
A	0.45	0.50	0.55
A1	0.00	0.02	0.05
A3	0.130 REF.		
b	0.20	0.25	0.30
D	1.90	2.00	2.10
D2	1.15	1.20	1.25
E	1.90	2.00	2.10
E2	0.55	0.60	0.65
e	0.500 BSC		
L	0.23	0.28	0.33

Recommended Footprint

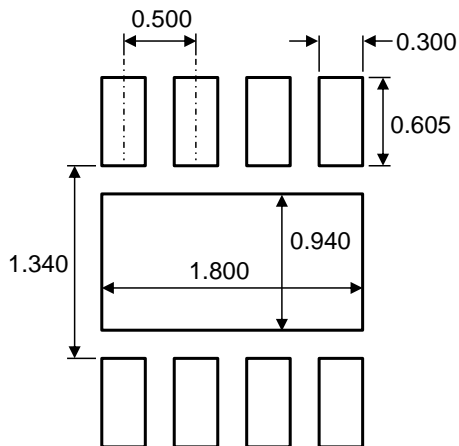

* Dimensions are in millimeters.