

USB Type-C Port Protector for CC and SBU Pins

Features

- Over-Voltage Protection
 - ▶ 24VDC Tolerance on CC1/2, SBU1/2
 - ▶ CC1/2 OVP = 5.8V
 - ▶ SBU1/2 OVP = 3.83V
 - ▶ Ultra-Fast 15ns Response Time
- IEC61000-4-5 Surge Protection
 - ▶ ±40V Surge Tolerance on CC1/2
 - ▶ ±30V Surge Tolerance on SBU1/2
- IEC61000-4-2 ESD Protection
 - ▶ ±15kV air gap on CC1/2, SBU1/2
 - ▶ ±8kV contact on CC1/2, SBU1/2
 - ▶ ±2kV HBM on all pins (JEDEC JS-001-2017)
- CC Switches:
 - ▶ 1.25A, 270mΩ, 40pF, 140MHz
 - ▶ Automatic 5.1kΩ dead battery pull-down
- SBU Switches:
 - ▶ 3Ω, 11pF, 800MHz
- 2.5V to 5.5V Operating Supply Voltage Range
- -40°C to 85°C Operating Temperature Range
- 16-bump WLCSP 1.7mmx1.7mm (0.4mm pitch)
- RoHS and Green Compliant

Brief Description

The KTU1120 provides four conducting paths with over-voltage protection (OVP) for USB Type-C, CC, and SBU signals. Once an over-voltage event is detected, it will shut down all paths to protect circuits in system side, like PD controller from damage.

All the SBU and CC switches have very low on-capacitance for broad bandwidth to allow high-speed signal passing through without loss. The CC1/2 switches have low on-resistance for passing V_{CONN} power up to 1.25A.

During dead battery conditions, internal 5.1kΩ resistors automatically pull down on CC1/2 to ensure that the up-stream source provides 5V on VBUS.

The KTU1120 is packaged in RoHS and Green compliant 16-bump WLCSP 1.7mmx1.7mm package.

Applications

- Notebook PCs, Netbooks, Tablets, Monitors, TVs
- Gaming Devices, Set-Top Boxes, Networking

Typical Application

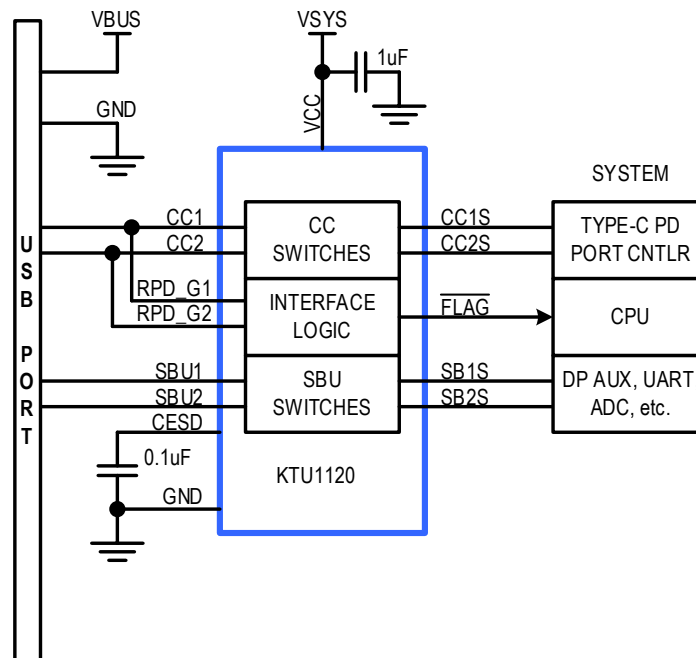

Pinout Diagram

WLCSP44-16

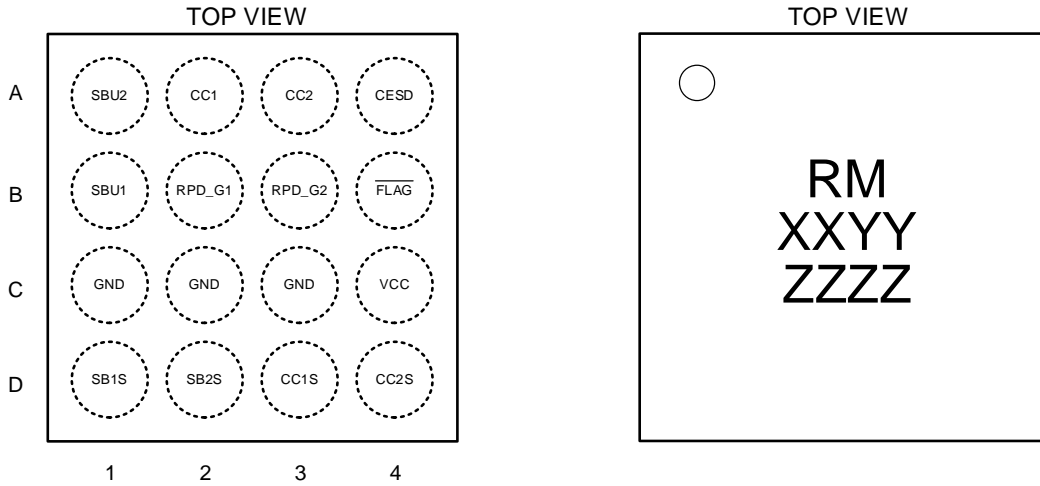

16-Pin 1.7mm x 1.7mm
WLCSP Package, 0.4mm pitch

Top Mark

RM = Device ID Code
XX = Date Code, YY = Assembly Code
ZZZZ = Serial Number

Pin Descriptions

Pin # (CSP)	Name	Function
B1	SBU1	Connector side of SBU1 switch
A1	SBU2	Connector side of SBU2 switch
A4	CESD	Capacitor connection for ESD protection for CC1, CC2, SBU1 and SBU2 inputs
A2	CC1	Connector side of CC1 switch
A3	CC2	Connector side of CC2 switch
C1 ~ C3	GND	Ground
B4	$\overline{\text{FLAG}}$	Active low fault flag output to alert system to an OVP fault condition
C4	VCC	Device supply input – connect to a 2.5V to 5.5V source.
D4	CC2S	System side of CC2 switch
D3	CC1S	System side of CC1 switch
D2	SB2S	System side of SBU2 switch
D1	SB1S	System side of SBU1 switch
B2	RPD_G1	Dead battery resistor setup: Short to CC1 if dead battery resistors are needed. Short it to GND if not needed
B3	RPD_G2	Dead battery resistor setup: Short to CC2 if dead battery resistors are needed. Short it to GND if not needed

Ordering Information

Part Number	Marking ¹	Operating Temperature	Package
KTU1120EGAB-TA	RMXXYYZZZZ	-40°C to +85°C	WLCSP44-16

1. XX = Date Code, YY = Assembly Code, ZZZZ = Serial Number

Absolute Maximum Ratings²

(T_A = 25°C unless otherwise noted)

Symbol	Description	Value	Units
V _{CC}	VCC to GND	-0.3 to 6	V
V _{IO}	CC1, CC2, RPD_G1, RPD_G2, SBU1, SBU2 to GND	-0.3 to 24	V
	CC1S, CC2S, SB1S, SB2S to GND	-0.3 to 8	
	FLAG to GND	-0.3 to 6	
I _{IO}	CC _n to CC _n S Continuous Current	±1250	mA
	CC _n to CC _n S Peak Current (2.5ms)	±2000	
	SBU _n to SB _n S, Continuous Current	±100	
V _{CESD}	CESD to GND	-0.3 to 24	V
T _J	Operating Temperature Range	-40 to 150	°C
T _S	Storage Temperature Range	-55 to 150	°C
T _{LEAD}	Maximum Soldering Temperature (at leads, 10 sec)	260	°C

ESD and Surge Ratings³

Symbol	Description	Value	Units
V _{ESD_HBM}	JEDEC JS-001-2017 ESD Human Body Model (all pins)	±2	kV
V _{ESD_CDM}	JEDEC JESD22-C101 Charged Device Model (all pins)	±500	V
V _{ESD_CD}	IEC61000-4-2 ESD Contact Discharge (CC1, CC2, SBU1, SBU2)	±8	kV
V _{ESD_AGD}	IEC61000-4-2 ESD Air-Gap Discharge (CC1, CC2, SBU1, SBU2)	±15	kV
V _{SURGE}	IEC61000-4-5 Surge (CC1, CC2 to GND)	±40	V
	IEC61000-4-5 Surge (SBU1, SBU2 to GND)	±30	V

Thermal Capabilities⁴

Symbol	Description	Value	Units
WLCSP-16			
θ _{JA}	Thermal Resistance – Junction to Ambient	96	°C/W
P _D	Maximum Power Dissipation at T _A ≤ 25°C	1300	mW
ΔP _D /ΔT	Derating Factor Above T _A = 25°C	-10.4	mW/°C

2 Stresses above those listed in Absolute Maximum Ratings may cause permanent damage to the device. Functional operation at conditions other than the operating conditions specified is not implied. Only one Absolute Maximum rating should be applied at any one time.

3 ESD and Surge Ratings conform to JEDEC and IEC industry standards. Some pins may actually have higher performance. Surge ratings apply with chip enabled, disabled, or unpowered based on Kinetic EVB, unless otherwise noted.

4 Junction to Ambient thermal resistance is highly dependent on PCB layout. Values are based on thermal properties of the device when soldered to an EV board.

Electrical Characteristics⁵

Unless otherwise noted, the *Min* and *Max* specs are applied over the full operation temperature range of -40°C to +85°C and $V_{CC} = 2.5V$ to $5.5V$. Typical values are specified at $T_A = +25^\circ C$ with $V_{CC} = 3.0V$.

Supply Specifications

Symbol	Description	Conditions	Min	Typ	Max	Units
V_{CC}	Supply Operating Range		2.5		5.5	V
V_{UVLO}	Under-Voltage Lockout Threshold	Rising threshold	2.12	2.3	2.48	V
		Hysteresis		100		mV
I_{CC}	Supply Current	$V_{CC} = 3.0V$		40		μA

Logic Specifications

Symbol	Description	Conditions	Min	Typ	Max	Units
V_{OL}	Output Logic Low (\overline{FLAG})	$I_{OSINK} = 3mA$		0.1	0.4	V
I_{O_LK}	Output Logic Leakage (\overline{FLAG})	$T_A = +25^\circ C$, $V_O = \text{high-Z or } V_{CC}$		0.01	1	μA
t_{FLAGB}	\overline{FLAG} Response Time (with 100k pull-up) ⁶	Activation		45		ns
$t_{FLAG_RECOVER}$	From OVP removed to \overline{FLAG} recovered			5		ms

Thermal Shutdown Specifications

Symbol	Description	Conditions	Min	Typ	Max	Units
T_{J_SHDN}	IC Junction Thermal Shutdown ⁶	T_J rising		150		$^\circ C$
		Hysteresis		20		$^\circ C$

(continued next page)

5. Device is guaranteed to meet performance specifications over the -40°C to +85°C operating temperature range by design, characterization and correlation with statistical process controls.

6. Guarantee by characterization and/or simulation.

Electrical Characteristics (continued)⁵

Unless otherwise noted, the *Min* and *Max* specs are applied over the full operation temperature range of -40°C to +85°C and $V_{CC} = 2.5V$ to $5.5V$. Typical values are specified at $T_A = +25^\circ C$ with $V_{CC} = 3.0V$.

CC Switch Specifications

Symbol	Description	Conditions	Min	Typ	Max	Units
$V_{CC1/2}$	Switch Voltage Operating Range		-0.3		5.5	V
V_{OVP_CC}	OVP Threshold	Rising threshold	5.6	5.8	6.0	V
		Hysteresis		50		mV
R_{ON_CC}	On-Resistance (-40°C ≤ T_J ≤ +85°C)	Value, $V_{CC1/2} = 0V$ to V_{CC}		270	390	mΩ
C_{ON_CC}	On-Capacitance ⁶	Capacitance from CCx or CCxS to GND when device is powered. Measure at $V_{CCx}/V_{CCxS} = 0V$ to $1.2V$, $f = 400kHz$.		40		pF
BW_{ON_CC}	On-Bandwidth ⁶	Measure the -3dB bandwidth from CCx to CCxS. Single ended measurement, 50Ω system. $V_{cm} = 0.1V$ to $1.2V$.		140		MHz
$R_{CC1/2_GND}$	Resistance to GND	$V_{CC1/2} \leq V_{CC}$, $T_A = +25^\circ C$	10	12.8		MΩ
I_{CCLK}	Switch Off Leakage Current	$V_{CC} = 0V$, $V_{CC1/2} = 5.5V$, $V_{CC1/2S} = 0V$, $T_A = +25^\circ C$, measure current out of CC1/2S		0.1	1	μA
$V_{CC1/2_DB}$	Dead Battery Threshold Voltage	$V_{CC} < V_{UVLO}$, $I_{CC1/2} = 80\mu A$	0.5	0.82	1.1	V
t_{ON_CC}	Switch Turn-On Time	V_{CC} rising > V_{UVLO}		1.3	3.5	ms
t_{OFF_CC}	Switch Turn-Off Time ⁶	V_{CC} falling < V_{UVLO}		1		μs
$t_{OVP_CC_R}$	OVP Rising Response Time ⁶	$V_{CC} = 3.0V$, short CC1/2 to VBUS (20V) $T_A = +25^\circ C$		15		ns
$V_{CC1/2S_MAX}$	OVP Rising Maximum System Voltage ⁶	Hot-Plug CCx with a 1 meter USB Type C Cable. Hot-Plug voltage CCx = 24V. $V_{CC} = 3.3V$. Place a 30Ω load on CCxS		7		V
$t_{OVP_CC_F}$	OVP Falling Debounce Time			0.9		ms

(continued next page)

Electrical Characteristics (continued)⁵

Unless otherwise noted, the *Min* and *Max* specs are applied over the full operation temperature range of -40°C to +85°C and $V_{CC} = 2.5V$ to $5.5V$. Typical values are specified at $T_A = +25^\circ C$ with $V_{CC} = 3.0V$.

SBU Switch Specifications

Symbol	Description	Conditions	Min	Typ	Max	Units
$V_{SBU1/2}$	Switch Voltage Operating Range		-0.3		4.5	V
V_{OVP_SBU}	OVP Threshold	Rising threshold	3.70	3.83	3.95	V
		Hysteresis		50		mV
R_{ON_SBU}	On-Resistance (-40°C ≤ T_J ≤ +85°C)	Value, $V_{SBU1/2} = 0V$ to V_{CC}		3	6.3	Ω
C_{ON_SBU}	On-Capacitance ⁶	Capacitance from SBUX or SBXS to GND when device is powered. Measure at $V_{SBUx}/V_{SBxS} = 0.3V$ to $4.2V$.		11		pF
BW_{ON_SBU}	On-Bandwidth Single Ended(-3dB) ⁶	Measure the -3dB bandwidth from SBUX to SBXS. Single ended measurement, 50Ω system. $V_{cm} = 0.1V$ to $3.6V$.		800		MHz
X_{TALK}	Crosstalk ⁶	Measure crosstalk at $f = 1$ MHz from SB1S to SBU2 or SB2S to SBU1. $V_{cm1} = 3.6V$, $V_{cm2} = 0.3V$. Terminate open sides to 50Ω.		-70		dB
$R_{SBU1/2_GND}$	Resistance to GND	$V_{SBU1/2} \leq V_{CC}$, $T_A = +25^\circ C$	10	12.8		MΩ
I_{SBULK}	Switch Off Leakage Current	$V_{CC} = 0V$, $V_{SBU1/2} = 4.5V$, $V_{SB1/2S} = 0V$, $T_A = +25^\circ C$, measure current out of SBU1/2S		0.1	1	μA
t_{ON_SBU}	Switch Turn-On Time	V_{CC} rising > V_{UVLO}		1.3	3.5	ms
t_{OFF_SBU}	Switch Turn-Off Time ⁶	V_{CC} falling < V_{UVLO}		1		μs
$t_{OVP_SBU_R}$	OVP Response Time ⁶	$V_{CC} = 3.0V$, initial $V_{SBU1/2} = 3.3V$, short SBU1/2 to VBUS (20V), $T_A = +25^\circ C$		15		ns
$V_{SB1/2S_MAX}$	OVP Rising Maximum System Voltage ⁶	Hot-Plug SBUX with a 1 meter USB Type C Cable. Hot-Plug voltage SBUX = 24V. $V_{CC} = 3.3V$. Put a 150nF capacitor in series with a 40Ω resistor to GND on SBUXS		6		V
$t_{OVP_SBU_F}$	OVP Falling Debounce Time			0.6		ms

Electrical Characteristics (continued)⁵

Unless otherwise noted, the *Min* and *Max* specs are applied over the full operation temperature range of -40°C to +85°C and $V_{CC} = 2.5V$ to $5.5V$. Typical values are specified at $T_A = +25^\circ C$ with $V_{CC} = 3.0V$.

Dead Battery Resistors Specifications

Symbol	Description	Conditions	Min	Typ	Max	Units
$t_{ON_DB_DELAY}$	From VCC exceeding UVLO to dead battery resistors are off. (CCx and SBUx channels should be on prior to DB off)			5.7	9.5	ms
$t_{ON_DB_OVP}$	From OVP recover to DB resistors back to turn off. Same period as $t_{FLAG_RECOVER}$. See Figure 2 for more details			5		ms
R_{DB}	Dead Battery Pull-Down Resistance	$V_{CC} < V_{UVLO}$, $V_{CC1/2} = 2.6V$	4.1	5.1	6.1	k Ω

Timing Diagrams

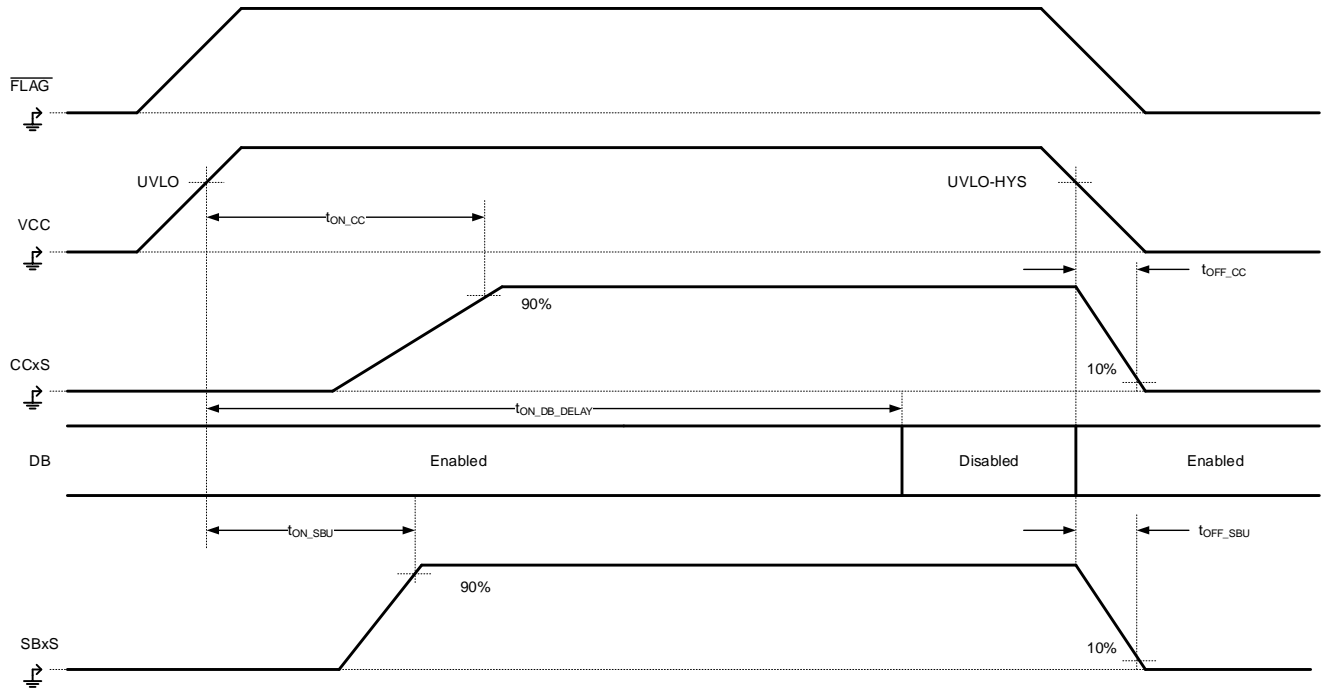

Figure 1. Power Up and Down

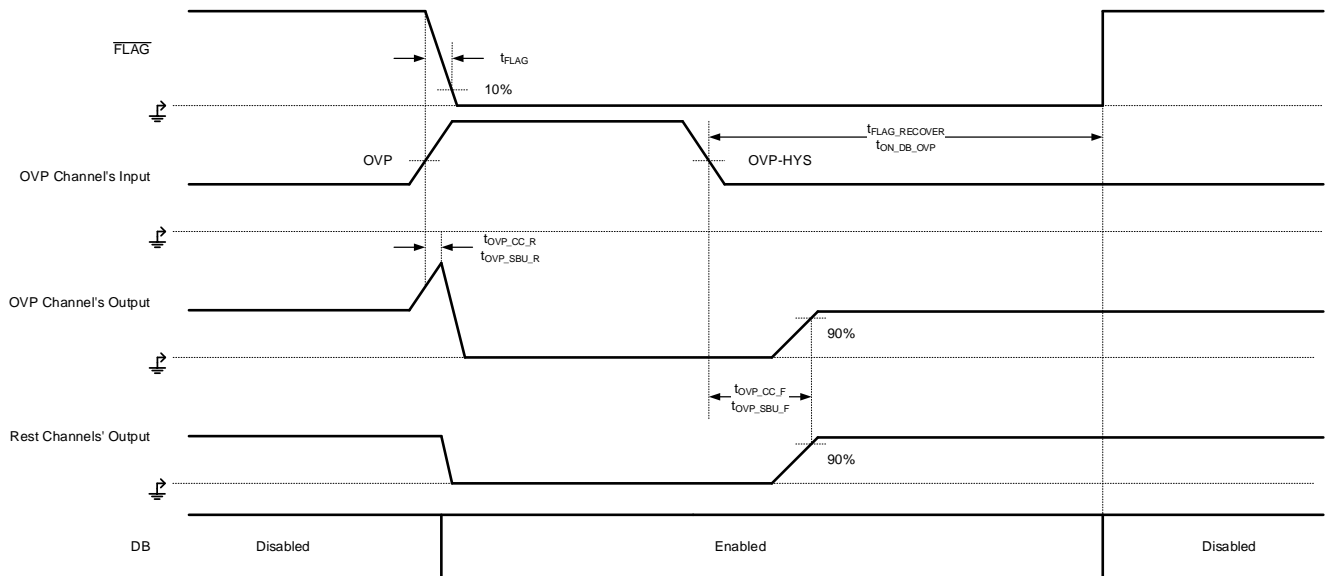

Figure 2. OVP

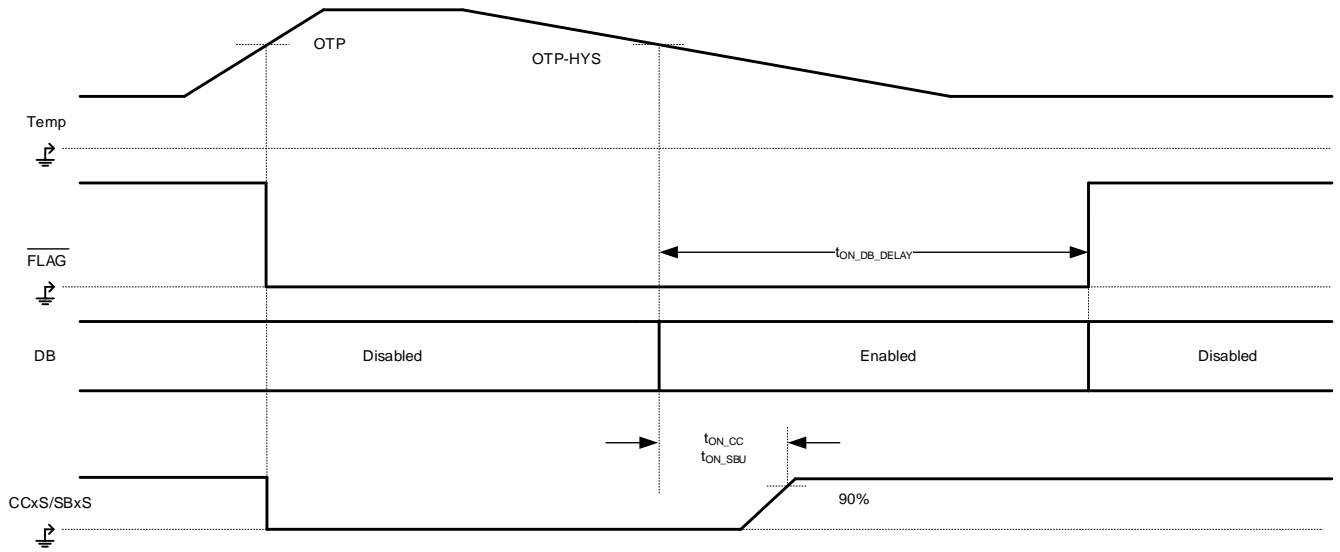
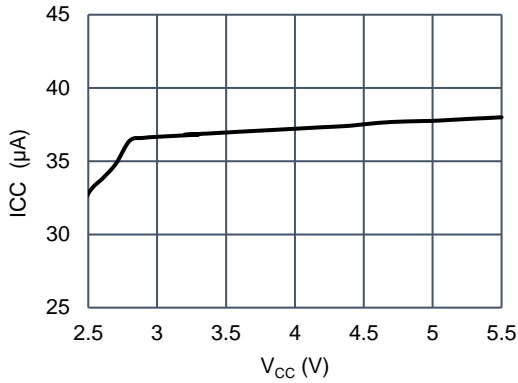

Figure 3. OTP

Typical Characteristics

$V_{CC} = 3.3V$, $C_{VCC} = 1\mu F$, $C_{ESD} = 0.1\mu F$, $T_{AMB} = 25^{\circ}C$ unless otherwise specified.

V_{CC} Supply Current vs V_{CC} Voltage



V_{CC} Supply Current vs. Temperature

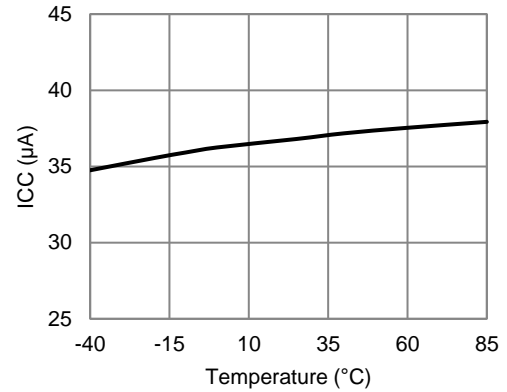

CC Switch R_{ON} vs. Switch Voltage
($I_{CC} = 200mA$)

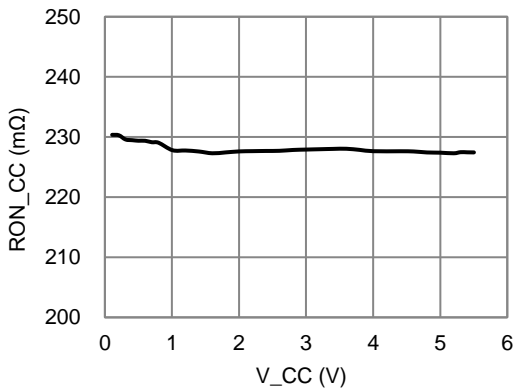

CC Switch R_{ON} vs. Switch Current

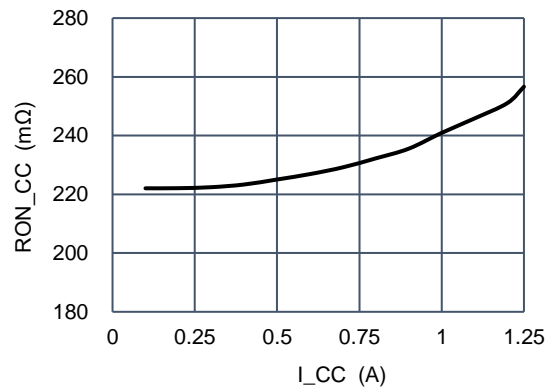

SBU Switch R_{ON} vs. Switch Voltage
($I_{SBU} = 100mA$)

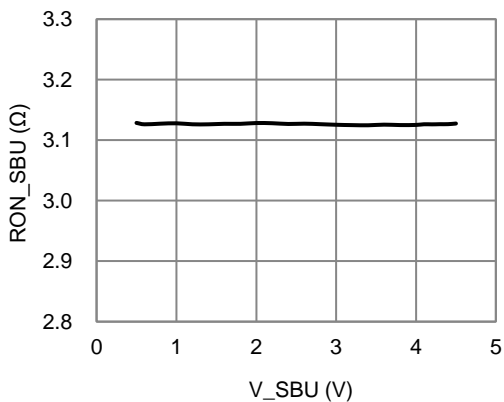

SBU Switch R_{ON} vs. Switch Current

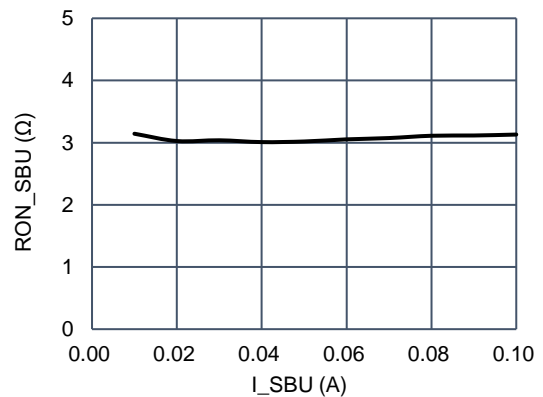

Typical Characteristics (continue)

$V_{CC} = 3.3V$, $C_{VCC} = 1\mu F$, $C_{ESD} = 0.1\mu F$, $T_{AMB} = 25^{\circ}C$ unless otherwise specified.

CC Switch OVP Level vs. Temperature

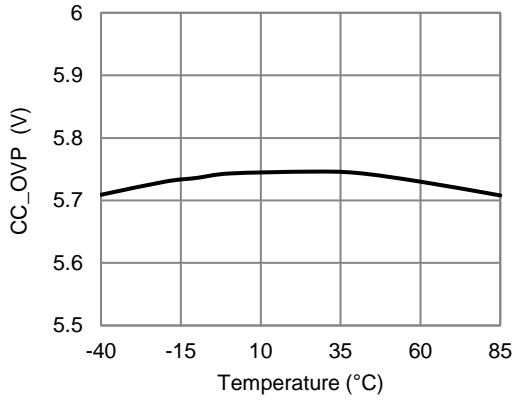

SBU Switch OVP Level vs. Temperature

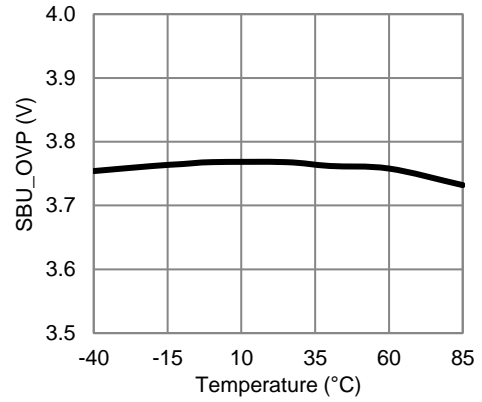

Hot-plug CC1 to 20V

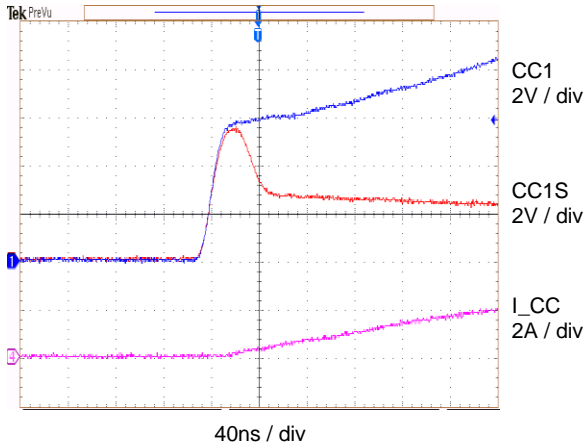

Hot-plug SBU1 to 20V

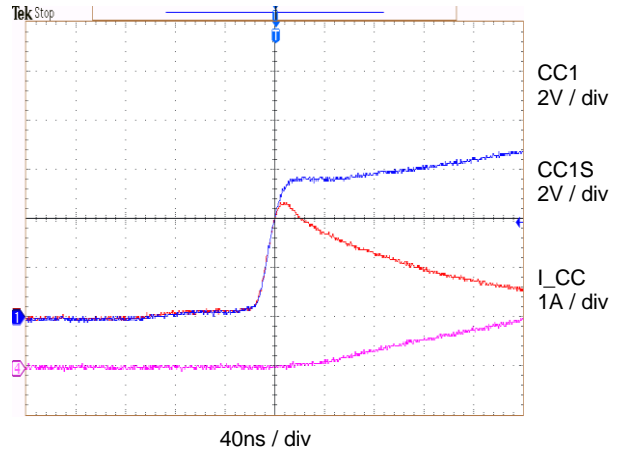

CCn Switch Bandwidth

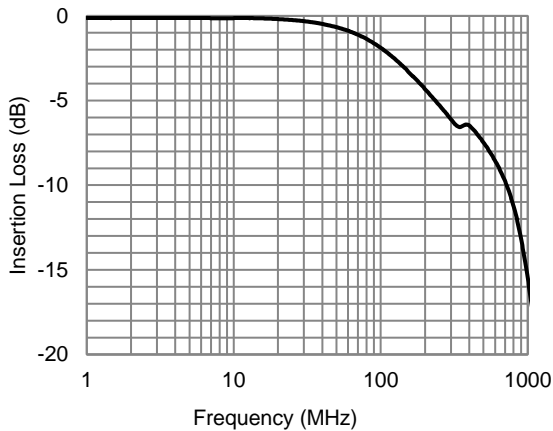

SBUn Switch Bandwidth

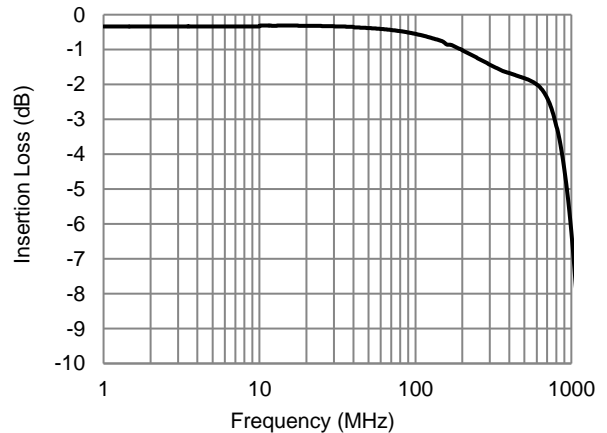

Typical Characteristics (continue)

$V_{CC} = 3.3V$, $C_{VCC} = 1\mu F$, $C_{ESD} = 0.1\mu F$, $T_{AMB} = 25^{\circ}C$ unless otherwise specified.

CC OVP during +40V Surge Event

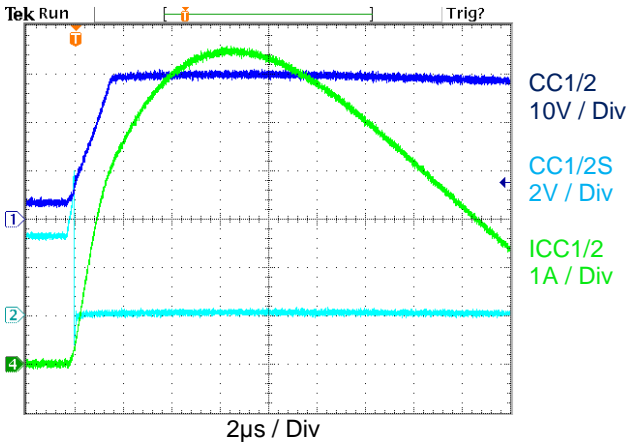

CC -40V Surge Event

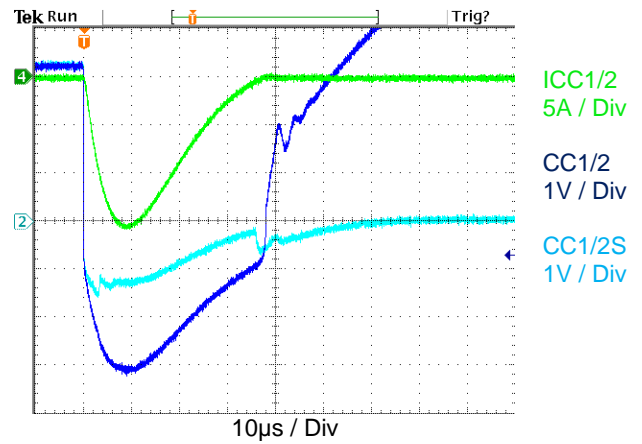

SBU OVP during +30V Surge Event

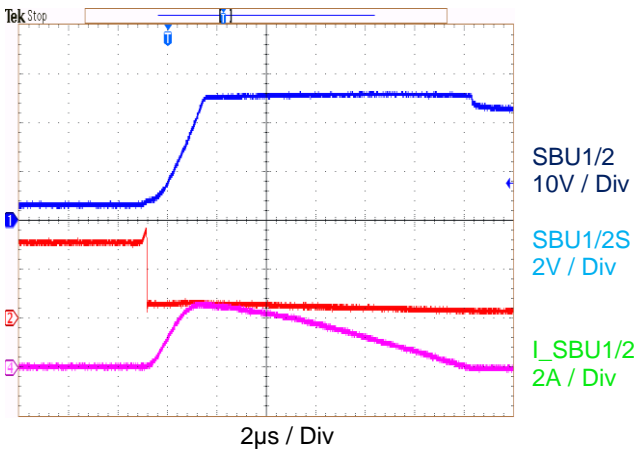

SBU -30V Surge Event

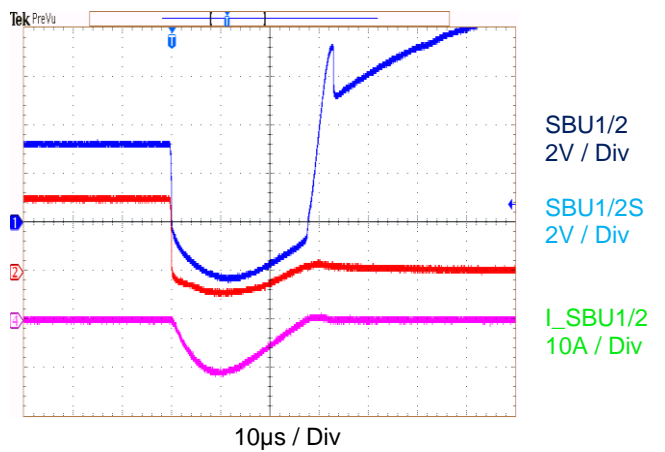

Functional Block Diagram

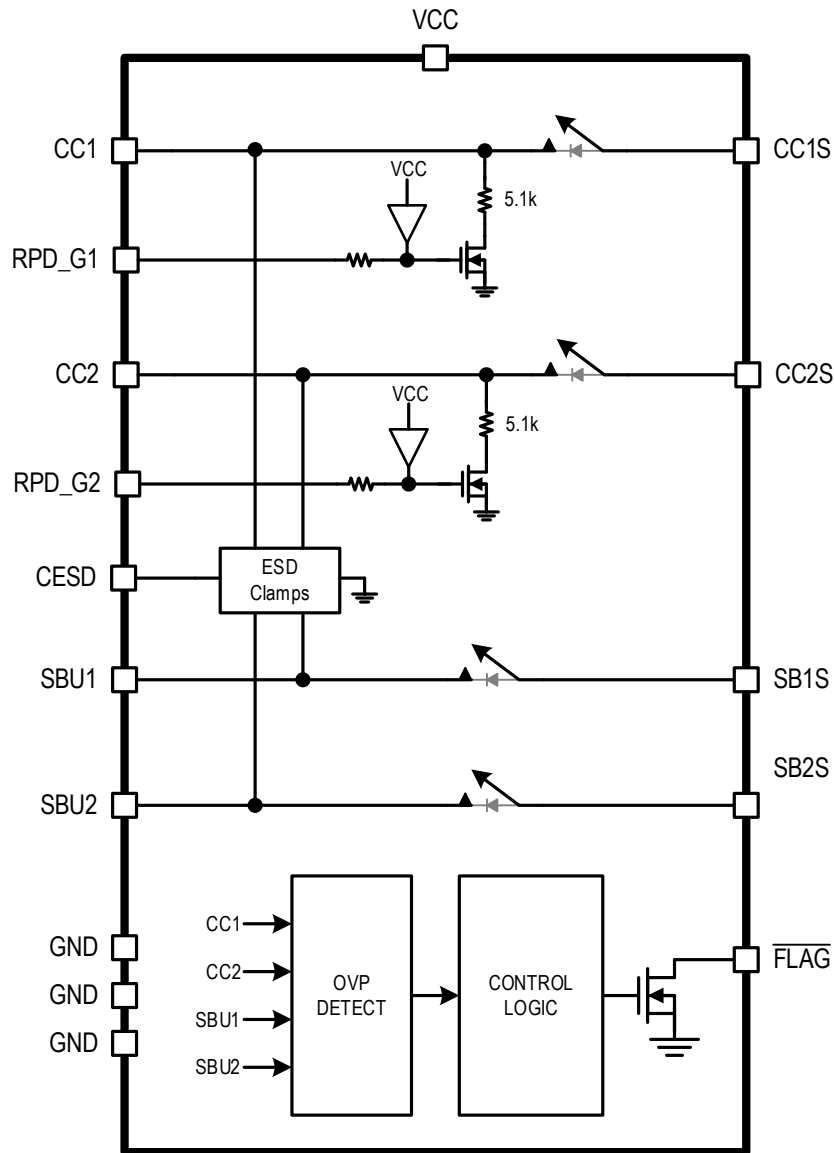

Functional Description

The KTU1120 integrates 4 switches to provide over-voltage protections for CC and SBU channels. Once there is a high voltage applied on any of them, for example, any of CC1/2 and SBU1/2 is shorted to VBUS (CC and SBU are adjacent to VBUS for a type-C connector.), all switches will be turned off to prevent the harmful voltage from being sent to system inside.

Power Up and Down

After V_{CC} ramps up and beyond UVLO, part will turn on CC and SBU switches with respective delays of t_{ON_CC} and t_{ON_SBU} . However, longer time of $t_{ON_DB_DELAY}$ needs to wait for exiting DB (disconnecting 5.1k from CCx to GND) if RPD_G1 and RPD_G2 are all connected to CC1 and CC2 respectively, until stable connections have been established for CC channels.

When V_{CC} ramps down and below UVLO, all switches are turned off, and DB resistors are re-connected immediately. More details could be found from “Power Up and Down” in “Timing Diagram” section.

Table 1. Control Logic Table (RPD_G1 and RPD_G2 are Connected to CC1 and CC2 Respectively)

IC Power	Conditions	Switch On/Off Status			FLAG
		CC1/2	SBU1/2	Dead Battery	
$V_{CC} > V_{UVLO}$	No Faults	ON	ON	OFF	High-Z
	$V_{CC1/2} > V_{OVP_CC}$	OFF	OFF	ON	Active Low
	$V_{SBU1/2} > V_{OVP_SBU}$	OFF	OFF	ON	Active Low
	$T_J > T_{J_SHDN}$	OFF	OFF	OFF	Active Low
$V_{CC} < V_{UVLO}$	$V_{CC1/2} = 2.6V$	OFF	OFF	ON	High-Z

Dead Battery Automatic 5.1kΩ Pull-Down

KTU1120 integrated pull down resistor from CCx to GND, which can be enabled by connecting RPD_G1 to CC1 and RPD_G2 to CC2. When under dead battery condition, DFP or adpaper can recognize the device through these pull down resistors and start to feed power in. After CC channels are turned on, KTU1120 cut those pull down resistors automatically with a short period of delay. And it reconnects those resistors when CCx channels are off, for example caused by UVLO or OVP, except OTP event.

See Figure 2 and Figure 3 for more details.

If no need for dead battery resistors, please short both RPD_G1 and RPD_G2 to ground.

Over-Voltage Protection

Once any of those channels meet with OVP event, KTU1120 will shut all channels at once. \overline{FLAG} will be pulled low to indicate there is a fault. After part is recovered, \overline{FLAG} would be released to High-Z again automatically.

Over-Temperature Protection

KTU1120 will also turn off all channels when OTP happens. \overline{FLAG} will be pulled low to indicate there is a fault. However, dead-battery resistors will not be presented when OTP is lasting. They will be presented when OTP is over and before CCx channels are closed. See Figure 2.

Applications Information

For typical USB Type-C CC and SBU input port protection applications, only two external components are required for the KTU1120 to provide protection functions.

Input Supply and Bypass Capacitor Selection

Place a 1.0 μ F/10V ceramic capacitor between the VCC pin and ground. X5R or X7R dielectric ceramic capacitors are preferred for input supply bypassing applications as they maintain better capacitance value and tolerances over operating voltage and temperature ranges when compared to lower cost Y5V dielectric type ceramic capacitors.

ESD Capacitor

KTU1120 utilizes an ESD support capacitor to meet ESD protection requirements. The ESD support capacitor should be placed between the CESD pin and ground. The CC1/2 and SBU1/2 inputs can have as much as 20V applied during a short-to-VBUS event. A 0.1 μ F/50V X5R or X7R dielectric ceramic capacitor is recommended for this application.

Dead Battery Detection / Operation

USB Type-C specification allows the host and peripheral device to charge internal batteries through the Type-C port receptacle. Dead battery detection is an important feature that allows a device to be charged when its internal battery supply is depleted. Another scenario for dead battery support is when the CC1/2 or SBU1/2 switches are shut down due to an OVP condition. Automatic 5.1k Ω dead battery pull-down resistors on the CC1/2 inputs signal to a connected upstream USB current source PD host or wall adapter to allow charging through the USB Type-C port VBUS. When an applied adapter senses a 5.1k Ω pull down on CC1/2, 5V should be applied to the VBUS line to enable charging. For this reason, the KTU1120 contains an automatic dead battery sub-circuit. The CC1/2 pin impedance to ground is 5.1k Ω when the IC is shut down by the UVLO function due to a dead battery. When the IC is enabled under regular operation conditions, the CC1/2 impedance to ground is switched to over 10M Ω to support normal CC line functions. Refer to Table 1 for the control logic of CC1/2 line-states versus operation conditions.

Moisture Testing

In systems that perform moisture detection on the USB port, it is typical to apply a test current through the KTU1120 in and out of the connector-side pins. Moisture presents itself as a resistance path from the connector-side pins to ground. The threshold for moisture detection is usually less than 1M Ω of external leakage resistance to ground. To simplify moisture detection, the KTU1120 features over 10M Ω internal impedance from the connector-side pins to ground. However, it is important to keep in mind that KTU1120's internal impedance reduces when the voltage on the connector-side pins (CC1/2, SBU1/2) is greater than the device supply voltage (V_{CC}). Therefore, it is important to use a weak test current for a suitably low moisture detection threshold. An alternate solution is to use a pullup resistor to a voltage source, for example, 30k Ω pull-up to 2.7V.

Fault Flag Operation

The KTU1120 fault flag will alert the system controller to an OVP, surge or IC over temperature fault. The fault flag circuit is an open-drain MOSFET output that connects the FLAG pin to ground when there is an active fault condition. Refer to the IC functional block diagram for internal fault flag circuit connections. Common system controllers can typically be configured to place a logic pull up on the fault flag input signal, in these cases the FLAG output can be connected directly to the controller I/O. If a logic pull-up termination is not available, the FLAG output may be manually pulled-up high to a logic level voltage supply through a 10k Ω or greater value resistor.

Recommended PCB Layout

See Figure 4 for an example PCB layout. When laying out a PCB, follow the below guidelines:

1. Place the bypass capacitors as close as possible to the VCC pin, and ESD protection capacitor as close as possible to the CESD pin. Capacitors must be attached to a solid ground. This minimizes voltage disturbances during transient events such as short-to-VBUS and ESD strikes.
2. The SBU lines must be routed as straight as possible, and any sharp bends must be minimized. Standard ESD recommendations apply to the CC1, CC2, SBU1, SBU2.
3. The optimum placement for the device is as close to the connector as possible:

- EMI during an ESD event can couple from the trace being struck to other nearby unprotected traces, resulting in early system failures.
 - The PCB designer must minimize the possibility of EMI coupling by keeping any unprotected traces away from the protected traces which are between the KTU1120 and the connector.
4. Route the protected traces as straight as possible.
 5. Eliminate any sharp corners on the protected traces between the TVS and the connector by using rounded corners with the largest radii possible.

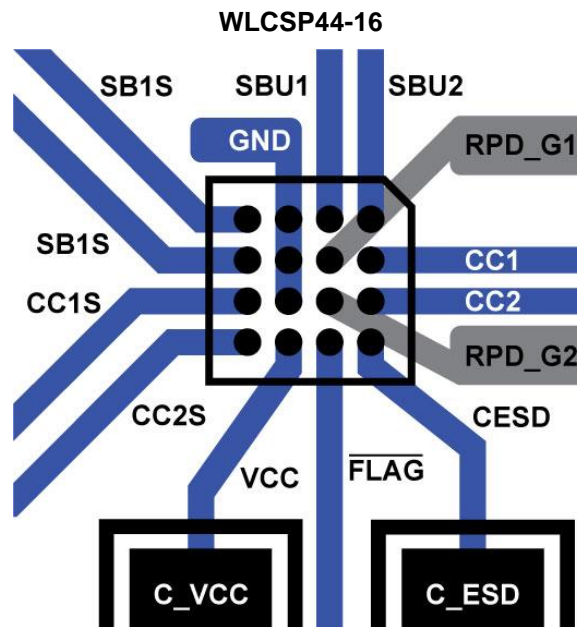

Figure 4. Recommended PCB Layout