

KU10R27NS

Thyristor Surge Suppressors
220V, 100A

Feature

- Bi-directional characteristic
- High-speed response characteristic
- Large surge current capacity
- Capable of repeated use for surges
- UL497B File No.E183905
- Pb free terminal
- RoHS:Yes

OUTLINE

Package (House Name): M2F

Package (JEDEC Code): DO-214AA similar



Equivalent circuit

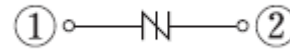

Absolute Maximum Ratings (unless otherwise specified : Tl=25°C)

Item	Symbol	Conditions	Ratings	Unit
Storage temperature	T _{stg}		-40 to 125	°C
Junction temperature	T _j		125	°C
Repetitive peak reverse voltage	V _{DRM}		220	V
Peak surge on-state current	I _{TSM}	10/1000μs, Non-repetitive	100	A

* :See the original Specifications

Electrical Characteristics (unless otherwise specified : Tl=25°C)

Item	Symbol	Conditions	Ratings			Unit
			MIN	TYP	MAX	
Clamping voltage	V _{CL}	dV/dt=100V/μs			320	V
Off-state current	I _{DSM}	VD=220V			5	μA
Holding current	I _H	Pulse measurement	100			mA
On-State Voltage	V _T	IT=2A			5	V
Junction capacitance	C _j	f=100kHz, VD=50V, OSC=1Vrms			70	pF

* :See the original Specifications

CHARACTERISTIC DIAGRAMS

On-State Voltage-On-State Current

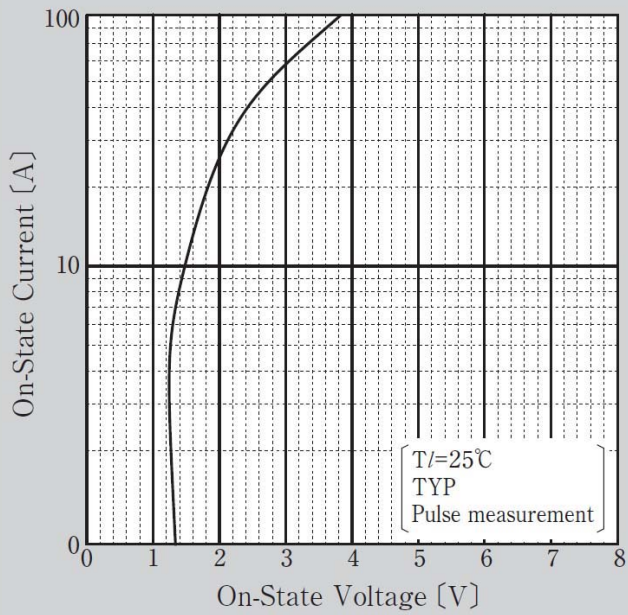

Breakover Voltage vs Junction Temperature

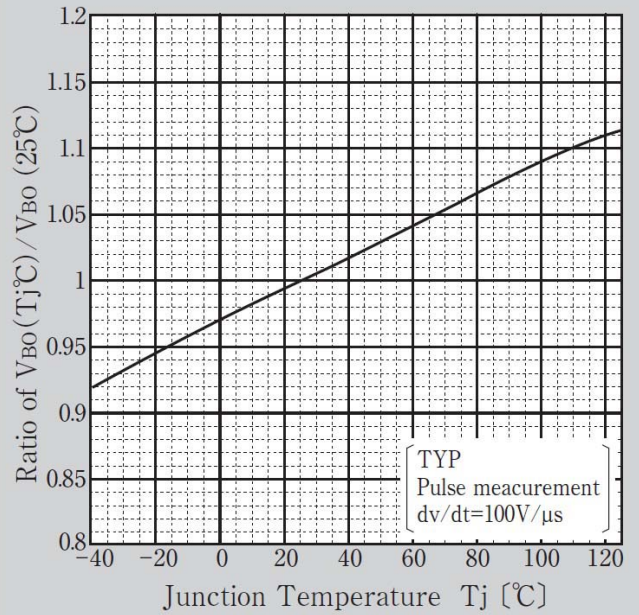

Holding Current vs Junction Temperature

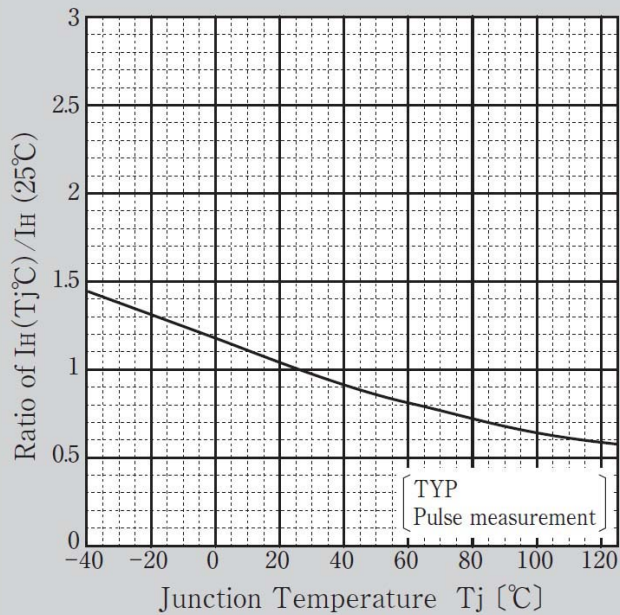

Junction Capacitance

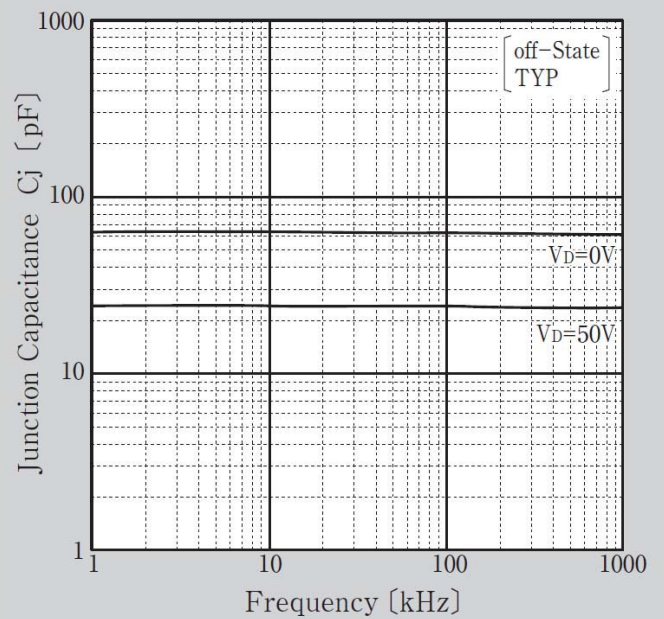

Junction Capacitance

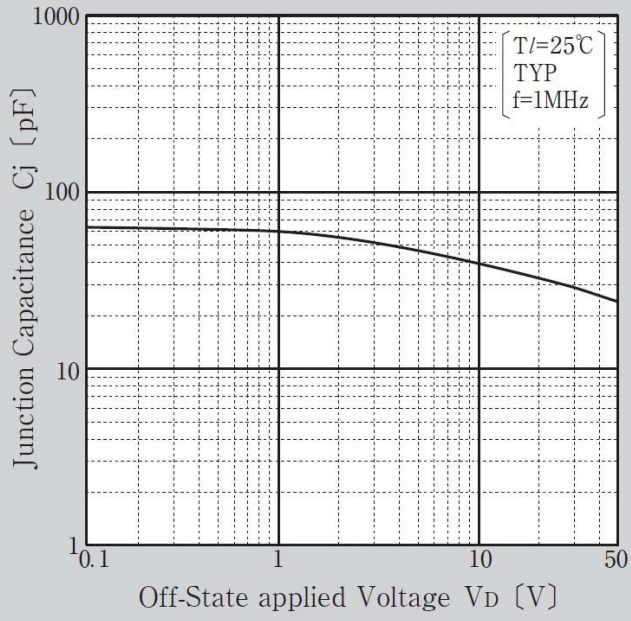

B7

JEDEC Code	DO-214AA similar
JEITA Code	—
House Name	M2F

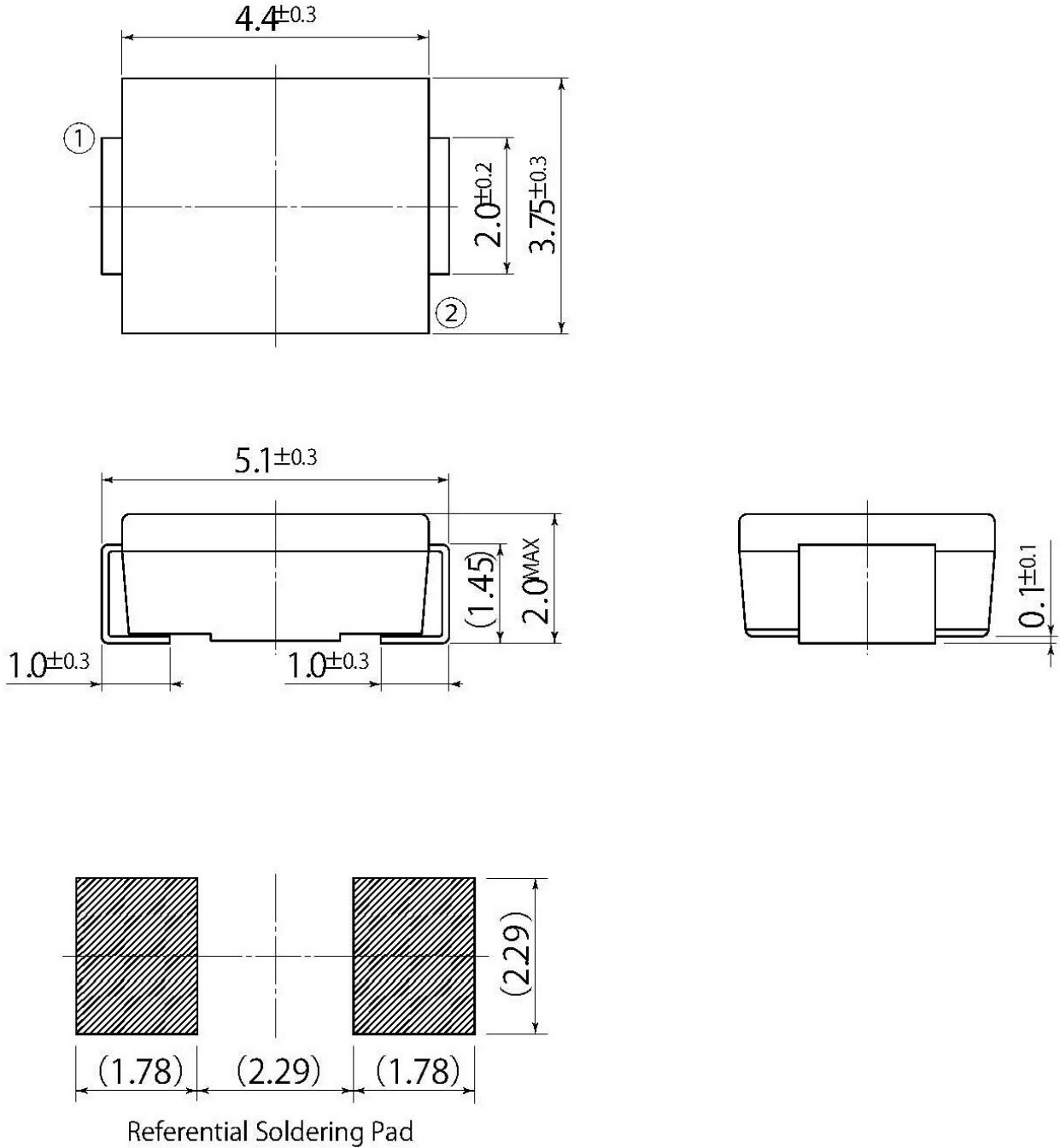

• Optimize soldering pad to the board design and soldering condition.