

# KU4F12

## Thyristor Surge Suppressors 100V, 40A

### Feature

- Bi-directional characteristic
- High-speed response characteristic
- Large surge current capacity
- Capable of repeated use for surges
- Pb free terminal
- RoHS:Yes

### OUTLINE

**Package (House Name):** M2F  
**Package (JEDEC Code):** DO-214AA similar



### Equivalent circuit

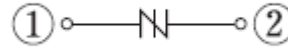

### Absolute Maximum Ratings (unless otherwise specified : Tl=25°C)

Item	Symbol	Conditions	Ratings	Unit
Storage temperature	T <sub>stg</sub>		-40 to 125	°C
Junction temperature	T <sub>j</sub>		125	°C
Repetitive peak reverse voltage	V <sub>DRM</sub>		100	V
Peak surge on-state current	I <sub>TSM</sub>	10/1000μs, Non-repetitive	40	A
Critical rate of rise of off-state voltage	dV/dt	VBO(min.)×0.63	1.5	kV/μs

\* : See the original Specifications

### Electrical Characteristics (unless otherwise specified : Tl=25°C)

Item	Symbol	Conditions	Ratings			Unit
			MIN	TYP	MAX	
Breakover voltage	V <sub>BO</sub>	dV/dt=8V/ms, Peak hold	110		125	V
Off-state current	I <sub>DSM</sub>	VD=100V			10	μA
Holding current	I <sub>H</sub>	Pulse measurement	100			mA
On-State Voltage	V <sub>T</sub>	IT=2A			3	V
Junction capacitance	C <sub>j</sub>	f=100kHz, VD=30V, OSC=20mVrms			100	pF

\* : See the original Specifications

# CHARACTERISTIC DIAGRAMS

### On-State Voltage-On-State Current

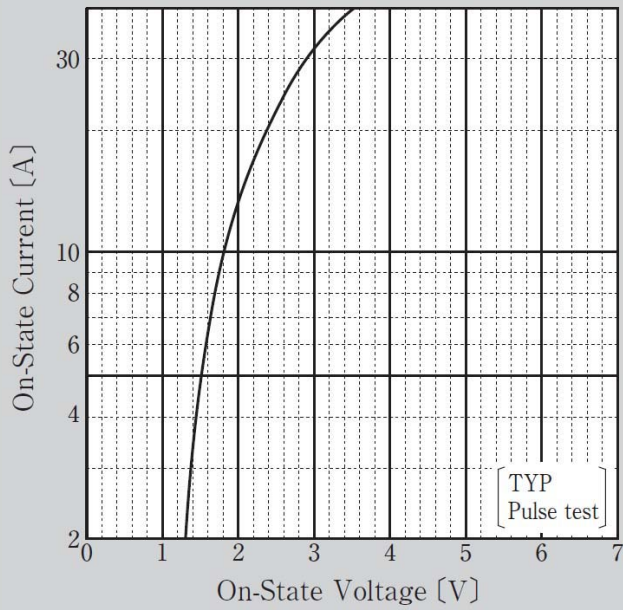

### Breakover Voltage vs Junction Temperature

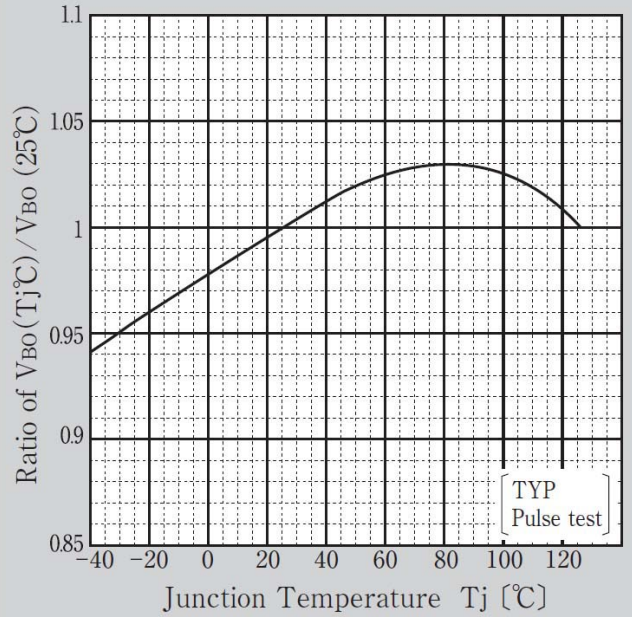

### Holding Current vs Junction Temperature

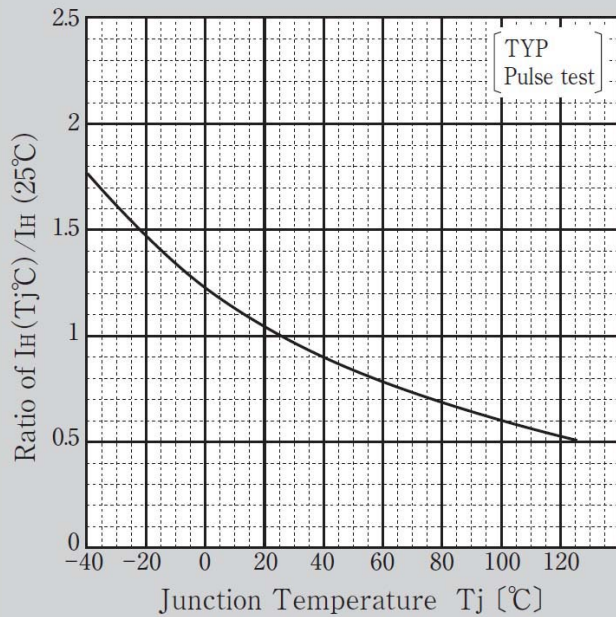

### Junction Capacitance

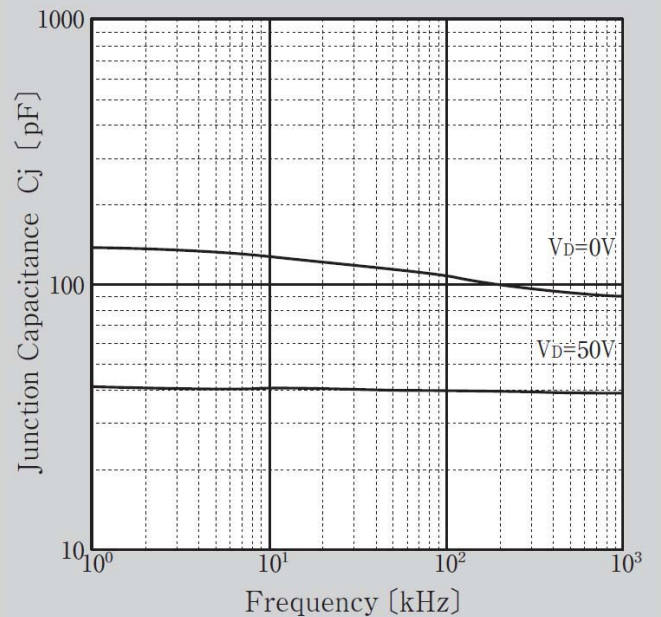

### Junction Capacitance

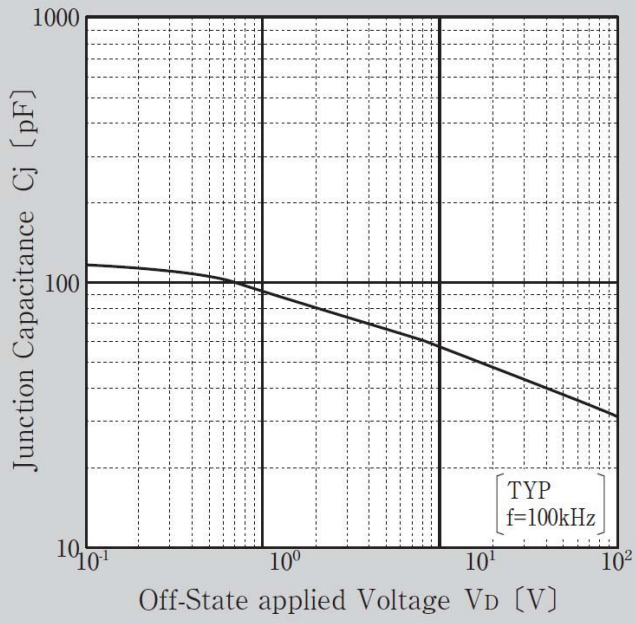

B7

JEDEC Code	DO-214AA similar
JEITA Code	—
House Name	M2F

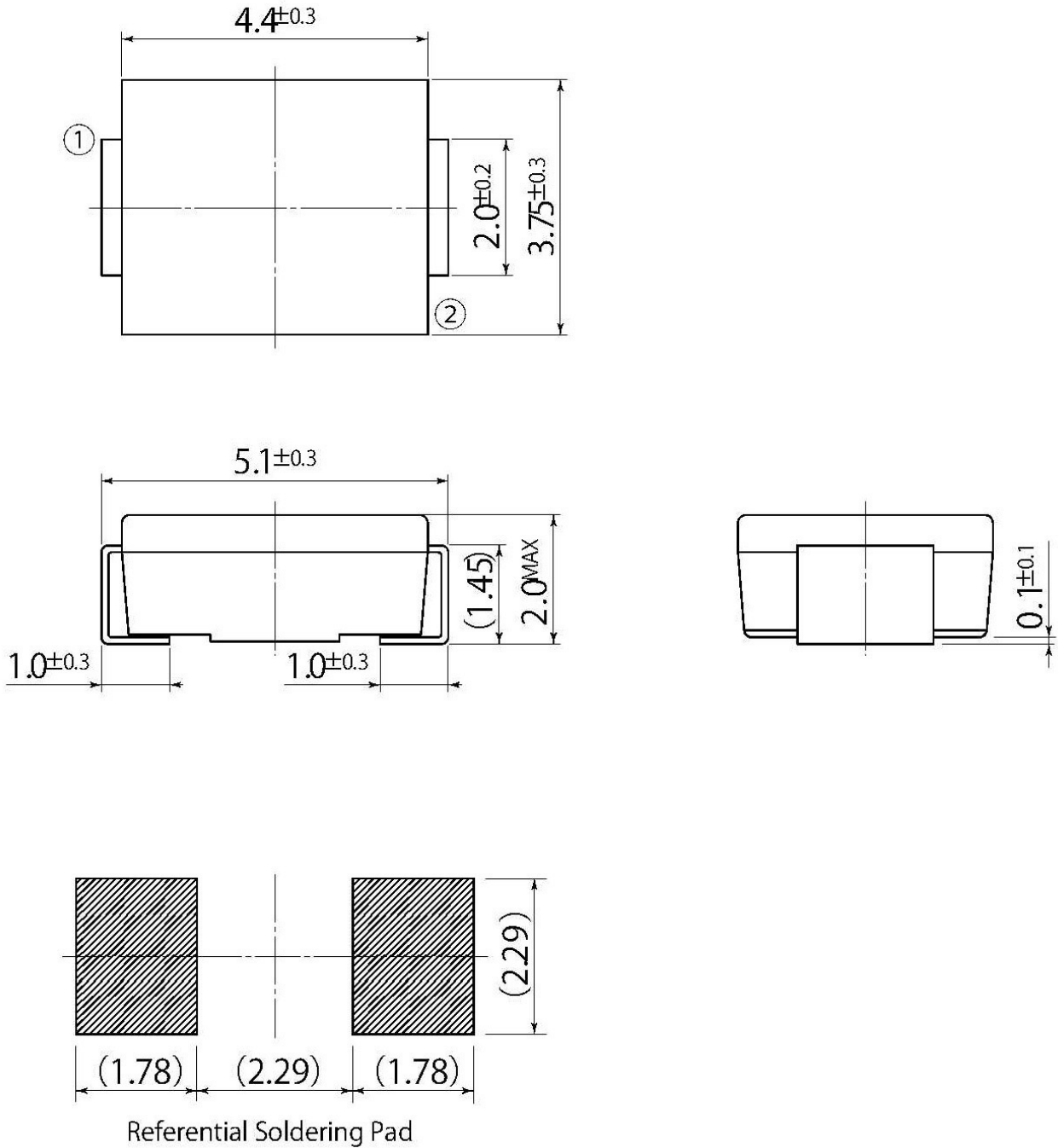

• Optimize soldering pad to the board design and soldering condition.