

KU4F8

Thyristor Surge Suppressors 70V, 40A

Feature

- Bi-directional characteristic
- High-speed response characteristic
- Large surge current capacity
- Capable of repeated use for surges
- Pb free terminal
- RoHS:Yes

OUTLINE

Package (House Name): M2F

Package (JEDEC Code): DO-214AA similar



Equivalent circuit

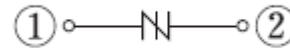

Absolute Maximum Ratings (unless otherwise specified : Tl=25°C)

Item	Symbol	Conditions	Ratings	Unit
Storage temperature	T _{stg}		-40 to 125	°C
Junction temperature	T _j		125	°C
Repetitive peak reverse voltage	V _{DRM}		70	V
Peak surge on-state current	I _{TSM}	10/1000μs, Non-repetitive	40	A
Critical rate of rise of off-state voltage	dV/dt	VBO(min.)×0.63	1.5	kV/μs

* : See the original Specifications

Electrical Characteristics (unless otherwise specified : Tl=25°C)

Item	Symbol	Conditions	Ratings			Unit
			MIN	TYP	MAX	
Breakover voltage	V _{BO}	dV/dt=8V/ms, Peak hold	75		98	V
Off-state current	I _{DSM}	VD=70V			10	μA
Holding current	I _H	Pulse measurement	100			mA
On-State Voltage	V _T	IT=2A			3	V
Junction capacitance	C _j	f=100kHz, VD=30V, OSC=20mVrms			100	pF

* : See the original Specifications

CHARACTERISTIC DIAGRAMS

On-State Voltage-On-State Current

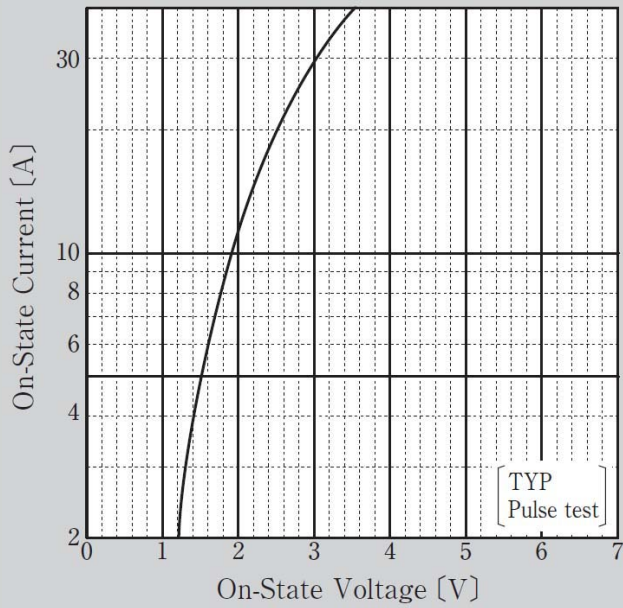

Breakover Voltage vs Junction Temperature

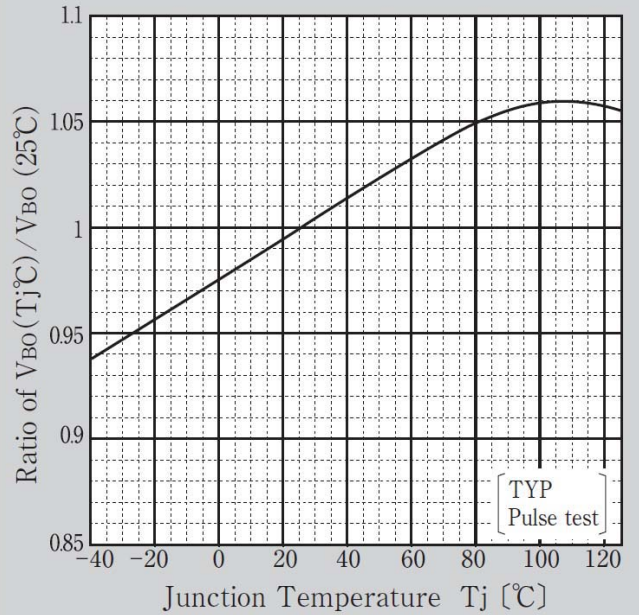

Holding Current vs Junction Temperature

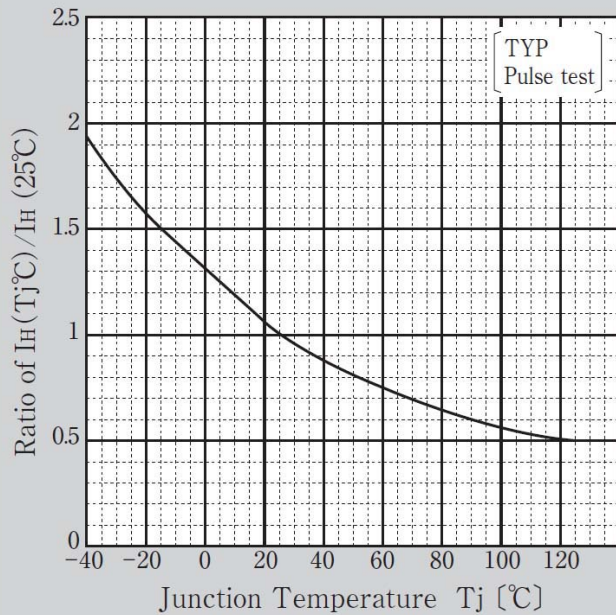

Junction Capacitance

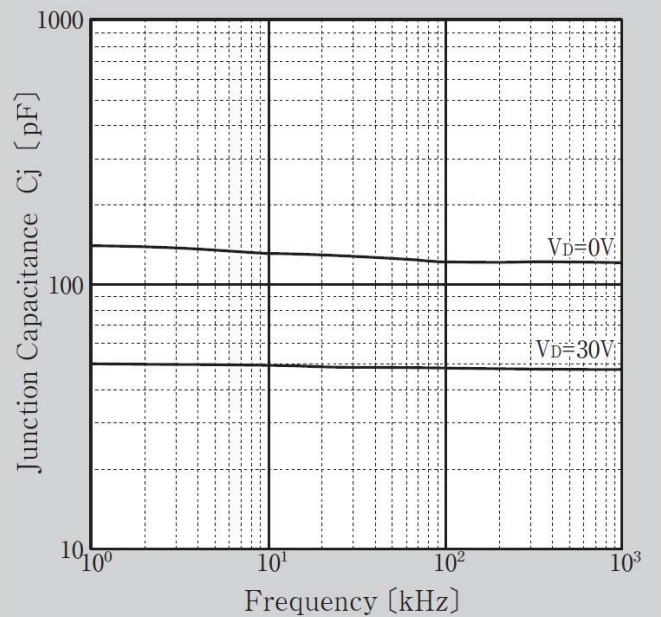

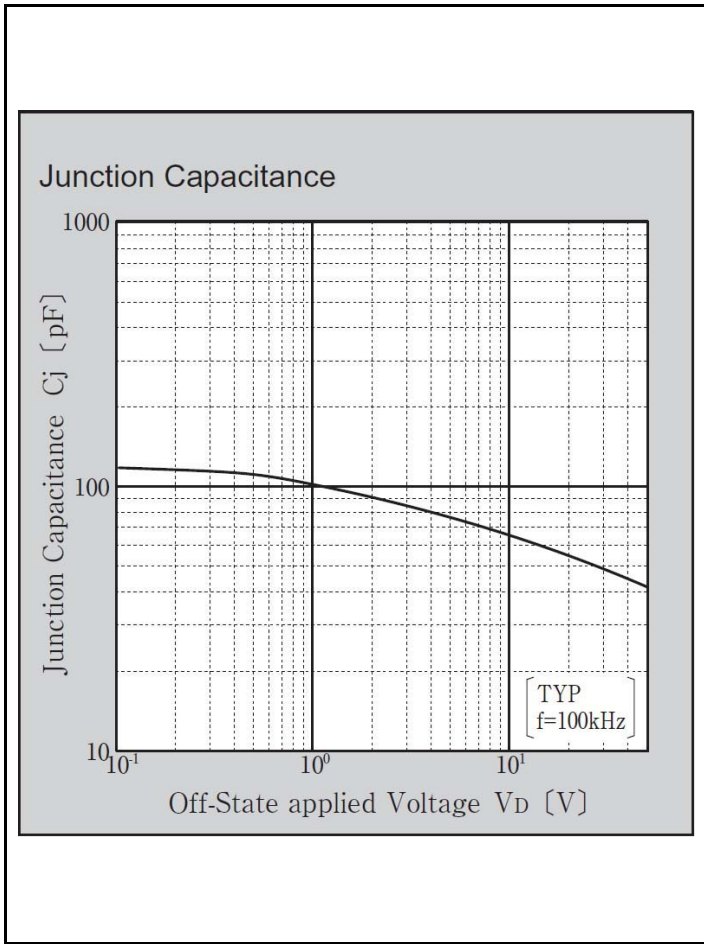

B7

JEDEC Code	DO-214AA similar
JEITA Code	—
House Name	M2F

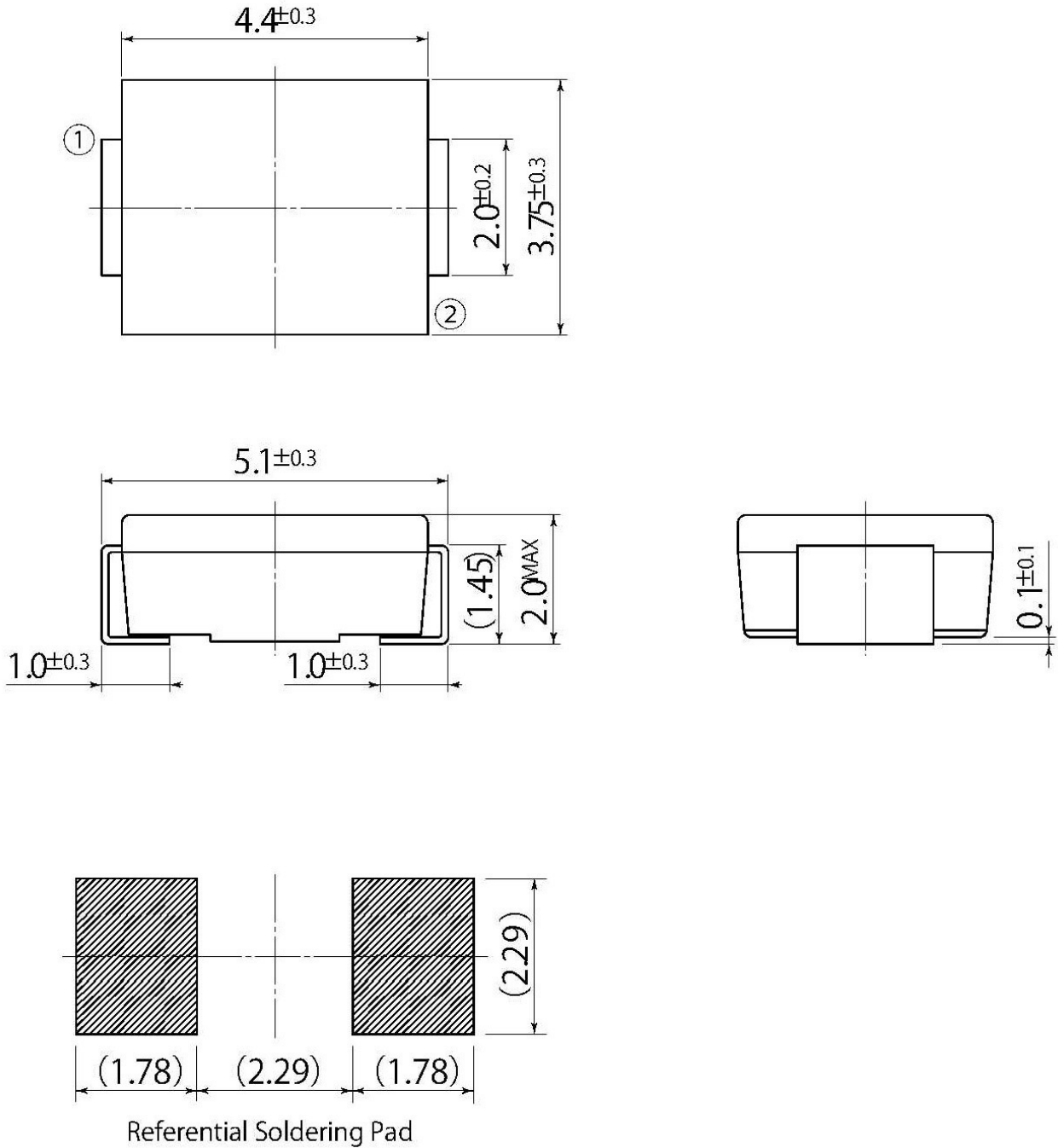

• Optimize soldering pad to the board design and soldering condition.