

KU5S31NS

Thyristor Surge Suppressors 275V, 50A

Feature

- Bi-directional characteristic
- High-speed response characteristic
- Large surge current capacity
- Capable of repeated use for surges
- Pb free terminal
- RoHS:Yes

OUTLINE

Package (House Name): M2F

Package (JEDEC Code): DO-214AA similar



Equivalent circuit

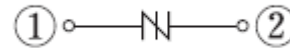

Absolute Maximum Ratings (unless otherwise specified : Tl=25°C)

Item	Symbol	Conditions	Ratings	Unit
Storage temperature	T _{stg}		-40 to 125	°C
Junction temperature	T _j		125	°C
Repetitive peak reverse voltage	V _{DRM}		275	V
Peak surge on-state current	I _{TSM}	10/1000μs, Non-repetitive	50	A

* :See the original Specifications

Electrical Characteristics (unless otherwise specified : Tl=25°C)

Item	Symbol	Conditions	Ratings			Unit
			MIN	TYP	MAX	
Clamping voltage	V _{CL}	dV/dt=100V/μs			420	V
Off-state current	I _{DSM}	VD=275V			5	μA
Holding current	I _H	Pulse measurement	150			mA
On-State Voltage	V _T	IT=2A			3	V
Junction capacitance	C _j	f=1MHz, VD=50V, OSC=1Vrms			70	pF

* :See the original Specifications

CHARACTERISTIC DIAGRAMS

On-State Voltage vs On-State Current

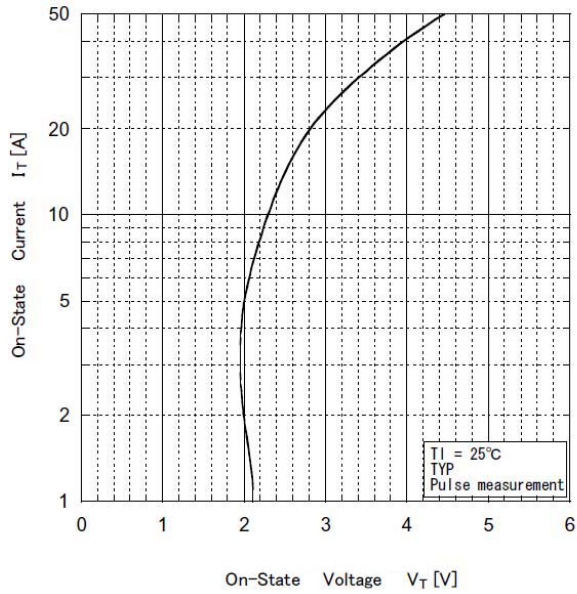

Clamping Voltage vs Junction Temperature

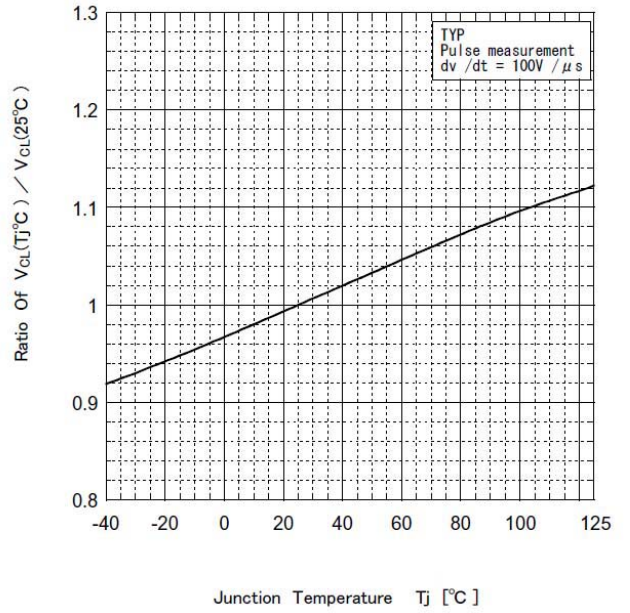

Holding Current vs Junction Temperature

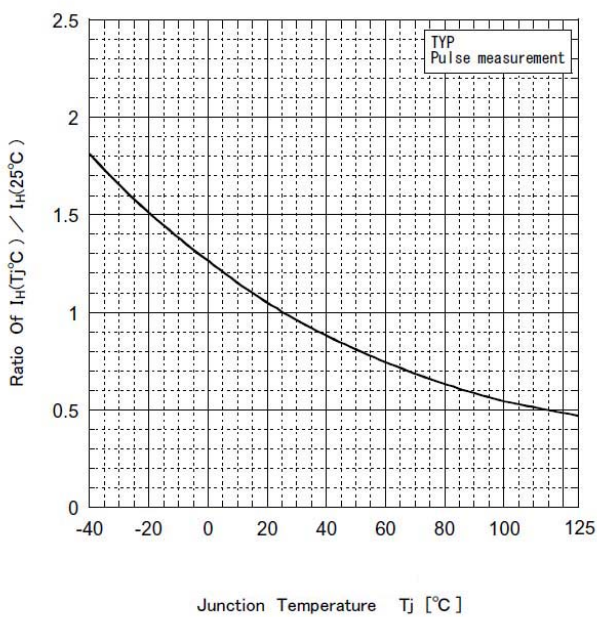

Junction Capacitance

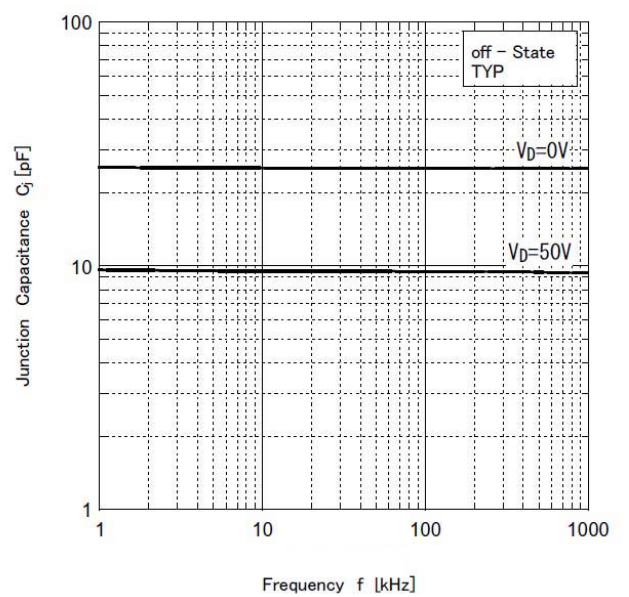

Junction Capacitance

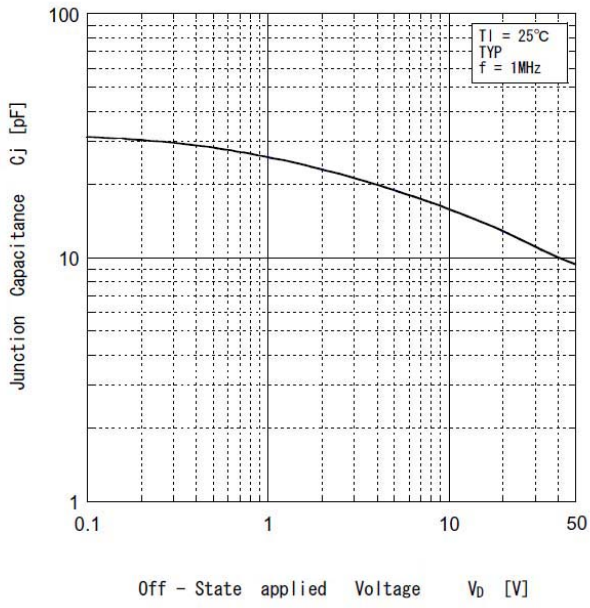

B7

JEDEC Code	DO-214AA similar
JEITA Code	—
House Name	M2F

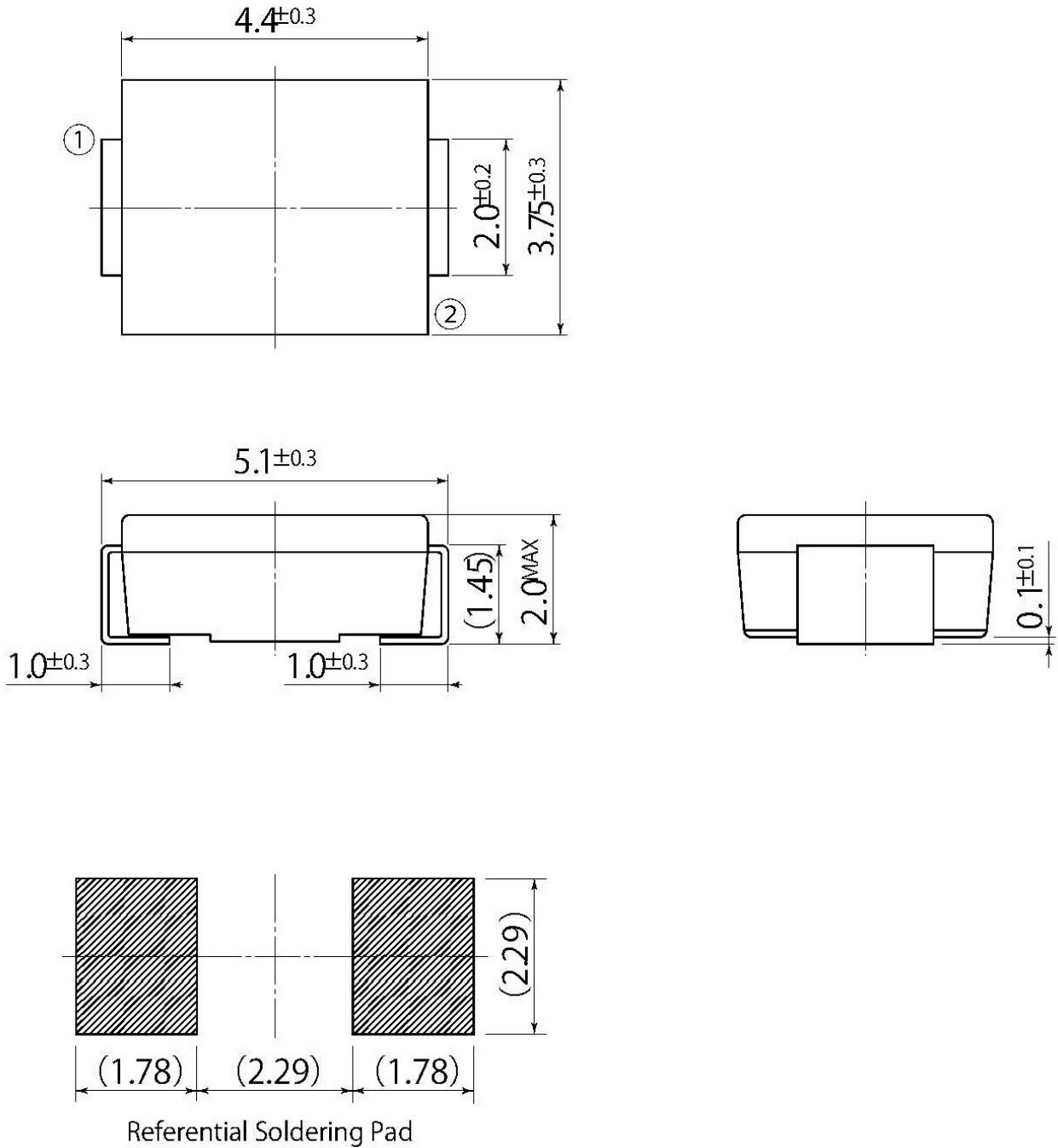

• Optimize soldering pad to the board design and soldering condition.