



RP20 max Antennas

Multi-Port MIMO Fixed Wireless Access Omnidirectional Antennas

RP20 max (L000320-XX) antennas are 5G/Cellular 2x2 MIMO omnidirectional antennas for Fixed Wireless Access (FWA) and IoT applications.

There are 2 and 3 port variants available with the 3-port models including GNSS coverage. Each model covers 617 - 6000 MHz and supports all major global 5G Cellular bands. These antennas can be mounted on a mast (pole), or wall and are suitable for both outdoor and indoor applications.

FEATURES AND BENEFITS

- Global LTE and 5G coverage (617-6000MHz)
- Operates in both CBRS as well as unlicensed 5-6 GHz
- Consistent omnidirectional patterns across all bands, providing stable reception
- Integrated pigtailed with a choice of terminated connectors
- Supplied with brackets and mounting hardware

APPLICATIONS

- Outdoor and indoor
- Fixed Wireless Access (FWA)
- Failover support
- Industrial IoT device connections
- Private networks

ELECTRICAL SPECIFICATION

Part Numbers	L000320-01 / L000320-02 / L000320-03 / L000320-04			
Operating Frequency (MHz)	617-960	1427-2700	3300-4800	4900-6000*
VSWR - Average	<2.5:1	<2.0:1	<2.0:1	<2.5:1
Peak Gain - Max (dBi)	3.0	5.6	4.0	4.6
Efficiency (%) Avg.	78	78	63	63
Input Max Power (W)	10			
Polarization	Linear, Vertical			
Azimuth Beamwidth (All Models)	360 °, Omnidirectional			
Nominal Impedance (Ohms)	50			

ELECTRICAL SPECIFICATION - GNSS*

Frequency	1559-1610
Passive Antenna Gain (dBic)	5.0
Active Antenna Gain (dBic)	32
LNA Gain (dB)	28 ± 3
Noise Figure @ room temp. (dB)	< 2.5
Polarization	RHCP
Nominal Impedance (ohm)	50
Operating Supply Voltage (Vdc)	2.5-7.0
Current Consumption, Max @ room temp. (mA)	8.5 ± 3 @ 3.0V
Out-of-band Signal Rejection, Min @ room temp. (dBc)	>80

* GNSS available on models L000320-02 & L000320-04

MECHANICAL SPECIFICATION

Dimensions - height x circumference - mm (in.)	554 x 74Ø (21.8 x 2.9)
Weight - g (oz.) - Dependent on Model	512-997(18-35)
Radome	Polycarbonate, UV (White)
Cap and Base	ASA, UV

ENVIRONMENTAL SPECIFICATION

Operating Temperature - °C (°F)	-40 to +85°C (-40 to +185°F)
Storage Temperature - °C (°F)	-40 to +85°C (-40 to +185°F)
Ingress Protection (IP Rating)	IP67
Material Substance Compliance	RoHS Compliant CE & UKCA
Wind Rating - Survival (mph)	110

PART NUMBER CONFIGURATIONS

PART NUMBER	PIGTAIL CONNECTOR	PIGTAIL LENGTH	NUMBER PORTS	FREQUENCY
L000320-01	SMA Male	500cm (16ft)	2 x Cellular	617-6000 MHz
L000320-02	SMA Male	500cm (16ft)	2 x Cellular 1 x GNSS	617-6000 MHz
L000320-03	Type N (Female)	50cm (1.6ft)	2 x Cellular	617-6000 MHz
L000320-04	Type N (Female)	50cm (1.6ft)	2 x Cellular 1 x GNSS	617-6000 MHz

GLOBAL 4G/5G CELLULAR COVERAGE

The **RP20 max** antenna provides global cellular coverage. The table below shows the frequencies and bands covered and the corresponding performance across those bands is shown in the charts below.

FREQUENCY	RF BANDS COVERED
617-698 MHz	71
698-960 MHz	5, 6, 8, 12, 13, 14, 17, 18, 19, 20, 26, 27, 28, 29, 44, 67, 68, 85 N5, N8, N12, N14, N18, N20, N28, N29, N81, N82, N83, N89, N91, N92, N93, N94
1427-1511 MHz	11, 21, 32, 45, 74 N50, N51, N74, N75, N76
1690-2700 MHz	1, 2, 3, 4, 7, 9, 10, 15, 16, 23, 25, 30, 33, 34, 35, 36, 37, 38, 39, 40, 41, 65, 66, 69, 70 N30, N34, N38, N39, N40, N41, N65, N66, N70, N80, N84, N86, N90, N95
3300-4200 MHz	22, 42, 43, 48 N48, N77, N78
4400-6000 MHz	N79
6000-7125 MHz*	46, 47 N96, N102, N104

TYPICAL VSWR

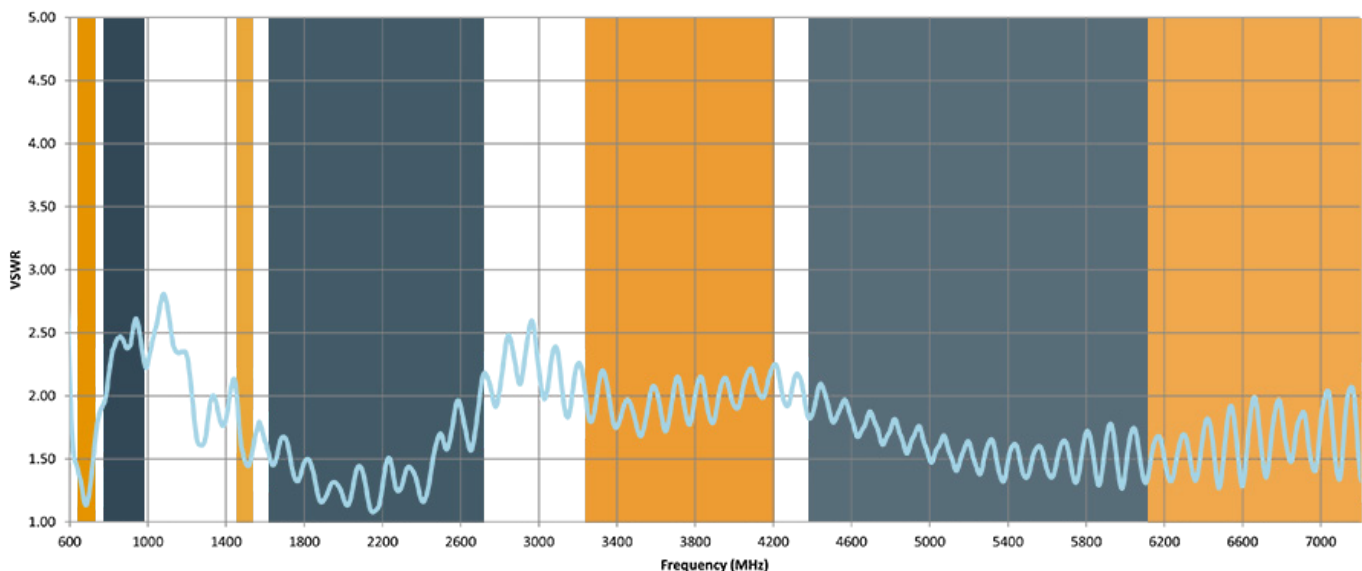

MECHANICAL DRAWINGS

L000320-01

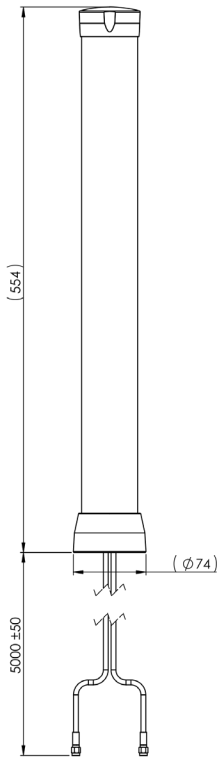

L000320-02

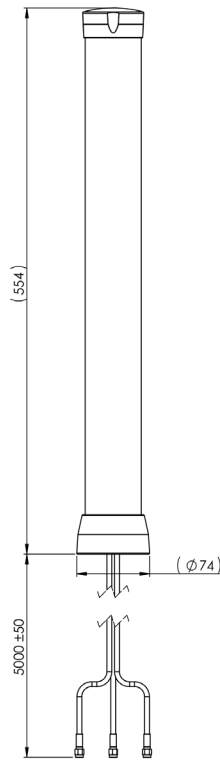

L000320-03

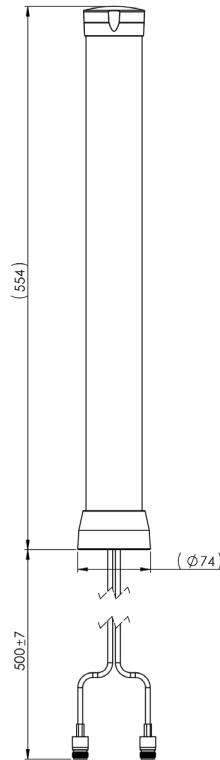

L000320-04

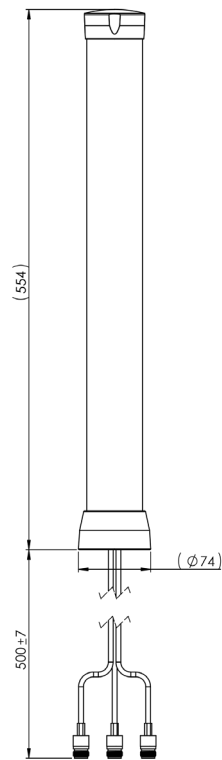

MOUNTING OPTIONS WITH INCLUDED HARDWARE

Pole Mounting Bracket

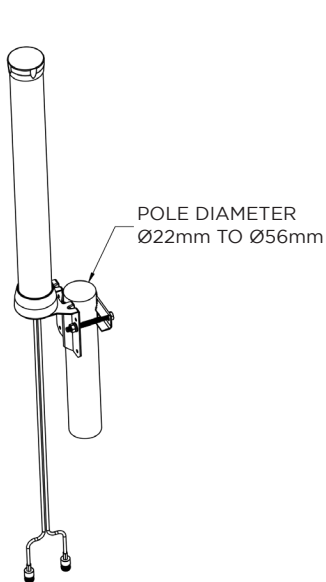

Wall Mounting Bracket

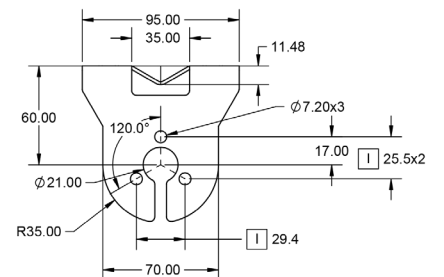
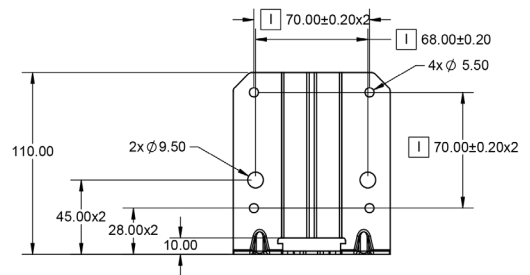
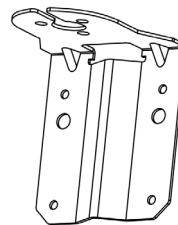
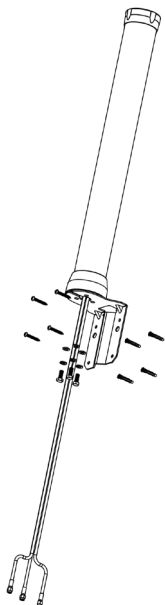

RADIATION PATTERNS

The radiation patterns below are representative of all models (2 and 3 port variants). For more detailed information and data please contact us.

Radiation Patterns at 617 MHz

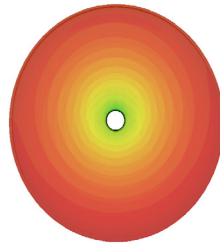
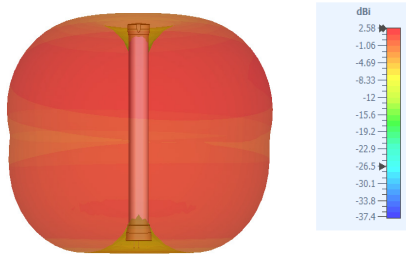

Radiation Patterns at 698 MHz

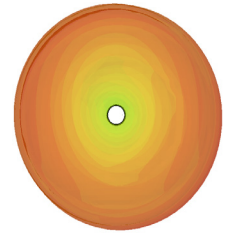
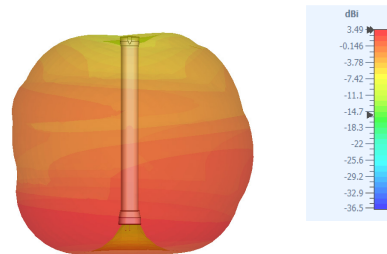

Radiation Patterns at 850 MHz

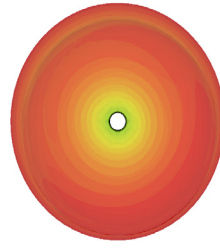
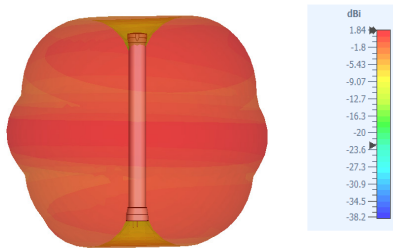

Radiation Patterns at 960 MHz

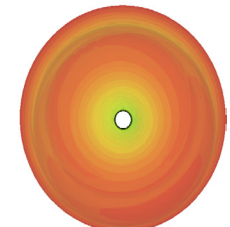
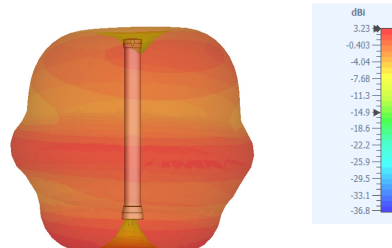

Radiation Patterns at 1500 MHz

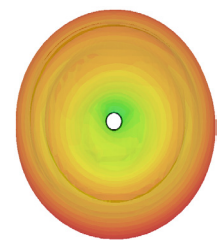
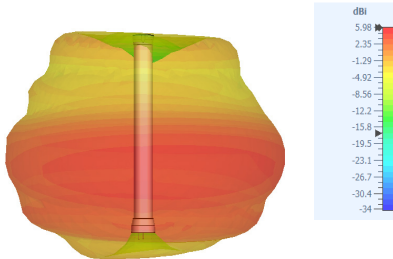

Radiation Patterns at 1700 MHz

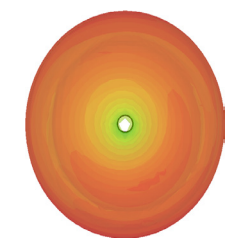
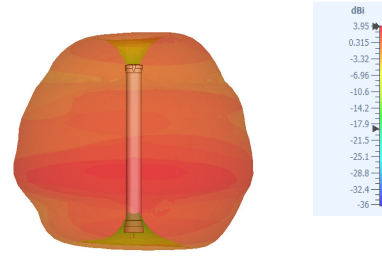

Radiation Patterns at 1850 MHz

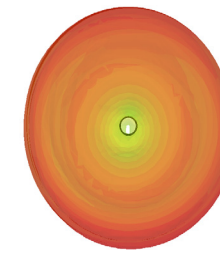
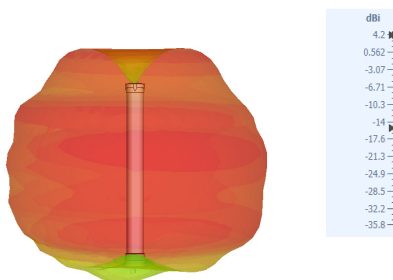

Radiation Patterns at 2000 MHz

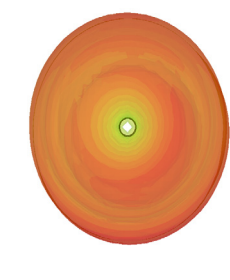
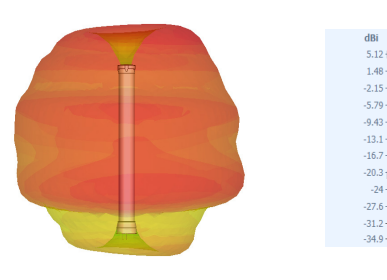

Radiation Patterns at 2500 MHz

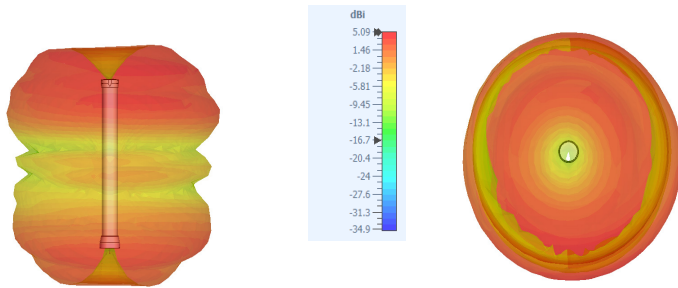

Radiation Patterns at 2700 MHz

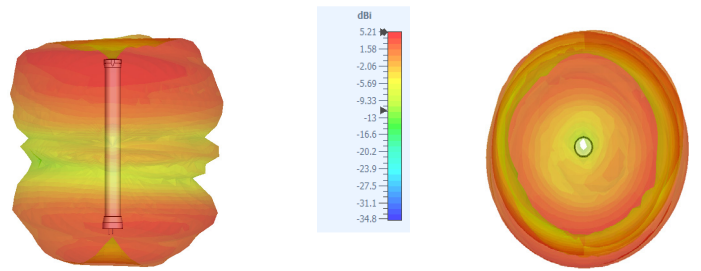

Radiation Patterns at 3500 MHz

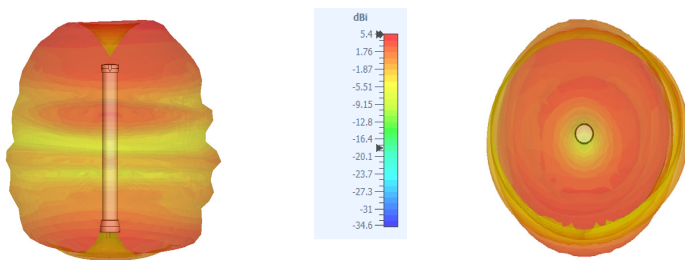

Radiation Patterns at 4900 MHz

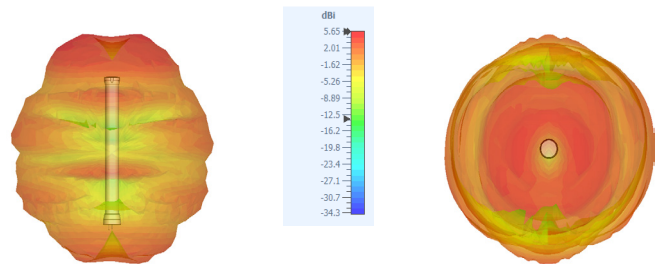

Radiation Patterns at 6000 MHz

