



FP20 AUTO MULTI-PORT ANTENNAS

INTELLIGENT TRANSPORTATION

Datasheet & Kit Configurator Guide



FP20 AUTO MULTI-PORT VEHICLE ANTENNAS

FP20 auto antennas provide a combination of 4G, 5G, CBRS, Wi-Fi, Bluetooth and GNSS to address your connectivity requirements.

The product family includes multi-port aerodynamic solutions up to 9-ports, along with a range of additional whip antenna and connector options to suit all major vehicular gateways and routers.

FEATURES AND BENEFITS

- 6, 7, 8 and 9 port options available
 - Wideband coverage
 - 4G/5G, Wi-Fi, Bluetooth, GNSS L1+L5 and optional VHF, UHF or 700/800/900 MHz (via high power whip port) coverage from a single antenna
 - Cost-effective solution to increase bandwidth and signal strength
 - Stylish and aesthetic design
-

KEY DIFFERENTIATORS

- L1 and L5 GNSS for improved positioning accuracy and response times
 - Dual-GNSS option available
 - Out of band rejection filters maintain consistent performance
 - High data throughput is enabled by technologies such as carrier aggregation
 - Coverage of all LTE/5G bands (617-7125 MHz), Wi-Fi, Bluetooth and GNSS
 - Truly global coverage of LTE and 5G sub-6 GHz frequencies and bands
 - Superior gain patterns, low gain ripple, high gain at horizon and efficiency over 70%
 - UV, flammability, humidity, impact, vibration, shock certified
-

TABLE OF CONTENTS

- [FP20 auto kit overview](#)
- [FP20 auto kit configurations](#)
- [FP20 auto base antenna specifications](#)
- [FP20 auto base antenna radiation patterns](#)
- [FP20 auto base antenna mechanical drawings](#)

FP20 AUTO: ANTENNA OVERVIEW

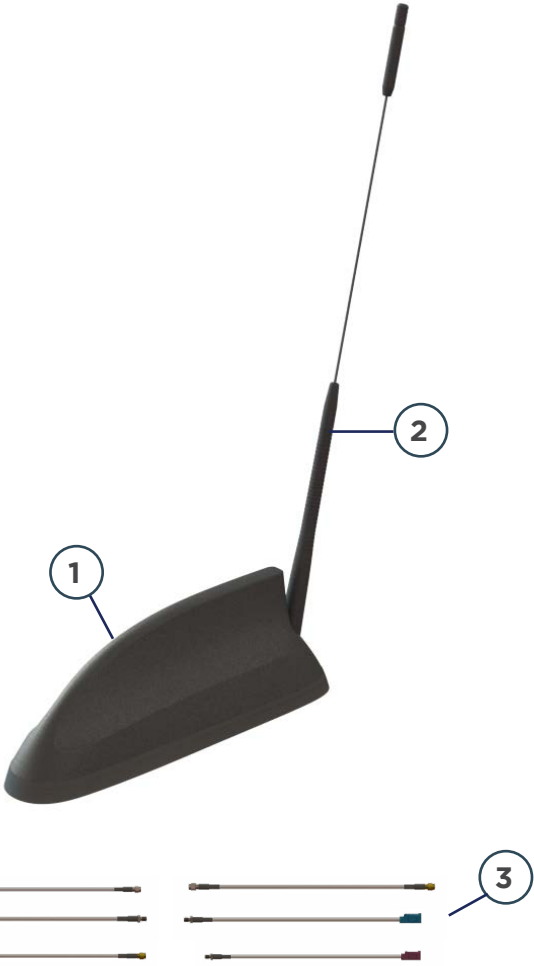

1 Port Options:

- 6 Port
- 7 Port
- 8 Port
- 9 Port

2 Whip Options:

- UHF - TETRA 380-430 MHz
- UHF 450-470 MHz
- UHF - 470-512 MHz
- 7/8/900 Band - 740-960 MHz
- Multi-Band - 150, 450, 7/800 MHz

3 Extension Cable Connector Options:

- SMA
- RP-SMA
- TNC
- QMA
- FAKRA

And More

EXAMPLES OF CONNECTOR TERMINATIONS ON EXTENSION CABLES

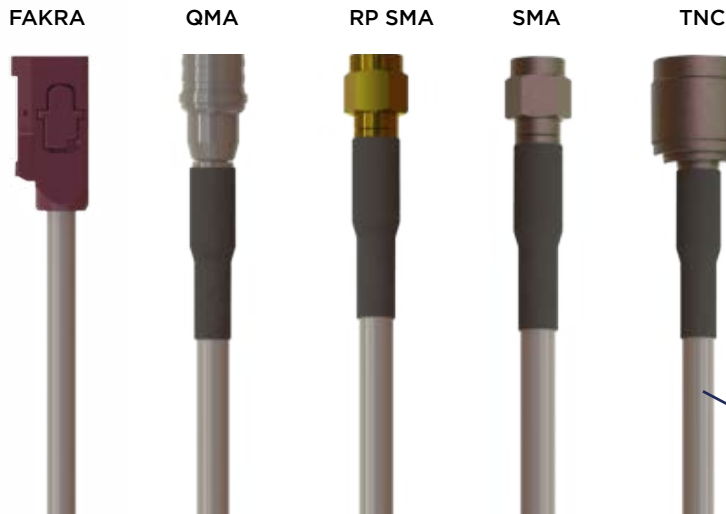

Extension Cables

All kits are supplied with a 5m extension cable set as standard (see pages 4-5 for standard extension cable connector options). Custom configurations are available on request.

Connectors will be individually marked with an appropriate label which is color coded to guide installers in connecting extension cables to the correct port on the router or gateway device.

4G/5G

GNSS





BT

WLAN

FP20 AUTO: KIT CONFIGURATIONS

The table below shows common examples of the **FP20 auto** kit configurations and the part numbers used to order these kits. Other kit options are available on request.

All kits are supplied with 5 meter (16 ft.) extension cables as standard. If you require different extension cable lengths or connector configurations please contact us to discuss your options.

| Example FP20 auto Base | Port Configuration | Frequency (MHz) | Extension Cable Connector |
|---|--------------------------|--|----------------------------|
| 6 Port Option 1 (No Whip Port) - Kit Part No. - L000423-01 | | | |
|  | 4G/5G Port x 2 | 617-7125 | SMA Male x 2 |
| | Wi-Fi/Bluetooth Port x 3 | 2400-2500; 4900-6000 | RP-SMA Male x 3 |
| | GNSS Port x 1 | L1: 1561 / 1575.42 / 1602 L5: 1176.45 | SMA Male x 1 |
| 6 Port Option 2 (Inc. Whip Port) - Kit Part No. - L000423-09 | | | |
|  | 4G/5G Port x 2 | 617-7125 | SMA Male x 2 |
| | Wi-Fi/Bluetooth Port x 2 | 2400-2500; 4900-7200 | RP-SMA Male x 2 |
| | GNSS Port x 1 | L1: 1561 / 1575.42 / 1602 L5: 1176.45 | SMA Male x 1 |
| | Whip Port x 1 | See below for options available | TNC Male x 1 |
| 7 Port Option 1 (Inc. Whip Port) - Kit Part No. - L000423-02 | | | |
|  | 4G/5G Port x 2 | 617-7125 | SMA Male x 2 |
| | Wi-Fi/Bluetooth Port x 2 | 2400-2500; 4900-7200 | FAKRA I x 1 FAKRA Z x 1 |
| | GNSS Port x 2 | L1: 1561 / 1575.42 / 1602 L5: 1176.45 | SMA Male x 2 |
| | Whip Port x 1 | See below for options available | TNC Male x 1 |
| 7 Port Option 2 (Inc. Whip Port) - Kit Part No. - L000423-03 | | | |
|  | 4G/5G Port x 2 | 617-7125 | SMA Male x 2 |
| | Wi-Fi/Bluetooth Port x 2 | 2400-2500; 4900-7200 | RP-SMA Male x 2 |
| | GNSS Port x 2 | L1: 1561 / 1575.42 / 1602 L5: 1176.45 | SMA Male x 2 |
| | Whip Port x 1 | See below for options available | SMA Male x 1 |

| Example FP20 auto Base | Port Configuration | Frequency (MHz) | Extension Cable Connector |
|--|--------------------------|--|---------------------------------|
| 8 Port (Inc. Whip Port) - Kit Part No. - L000423-04 | | | |
|  | 4G/5G Port x 2 | 617-7125 | SMA Male x 2 |
| | Wi-Fi/Bluetooth Port x 4 | 2400-2500; 4900-7200 | RP-SMA Male x 4 |
| | GNSS Port x 1 | L1: 1561 / 1575.42 / 1602 L5: 1176.45 | SMA Male x 1 |
| | Whip Port x 1 | See below for options available | TNC Male x 1 |
| 9 Port Option 1 (Inc. Whip Port) - Kit Part No. L000423-05 | | | |
|  | 4G/5G Port x 2 | 617-7125 | SMA Male x 2 |
| | Wi-Fi/Bluetooth Port x 4 | 2400-2500; 4900-7200 | RP-SMA Male x 3 QMA Male x 1 |
| | GNSS Port x 2 | L1: 1561 / 1575.42 / 1602 L5: 1176.45 | SMA Male x 1 QMA Male x 1 |
| | Whip Port x 1 | See below for options available | QMA Male x 1 |
| 9 Port Option 2 (Inc. Whip Port) - Kit Part No. - L000423-06 | | | |
|  | 4G/5G Port x 2 | 617-7125 | SMA Male x 2 |
| | Wi-Fi/Bluetooth Port x 4 | 2400-2500; 4900-7200 | RP-SMA Male x 4 |
| | GNSS Port x 2 | L1: 1561 / 1575.42 / 1602 L5: 1176.45 | SMA Male x 2 |
| | Whip Port x 1 | See below for options available | TNC Male x 1 |

| Additional Whip Options (For 6-9 Inc. Whip Port Models)* | | | | |
|--|--------------------------|--------------------------|--------------------------|------------------------------|
| SINGLE BAND | | | | TRI-BAND |
| UHF - TETRA | UHF | UHF | 7/800 Band | Multi-Band |
| 380-430 MHz | 450-470 MHz | 470-512 MHz | 740-960 MHz | 150, 450, 700/800/900 MHz |
| Part No. - L000410-01 | Part No. - L000410-02 | Part No. - L000410-03 | Part No. - L000410-04 | Part No. - L000340-01 |
| FP20 auto whip port and the associated whip antennas are designed to handle 60 watts | | | | |

***Please note whip antenna part numbers are not included in a standard FP20 auto kit**

The part numbers above must be ordered separately. When placing an order please state the kit number from the tables above plus the additional whip antenna part number and quantities required for both kit and whip.

FP20 AUTO: SPECIFICATIONS

The following specifications are representative of all models/port options in the **FP20 auto** antenna family. Unless stated the data includes testing of the antenna only and does not include testing with a 5 meter (16 feet) extension cable. For more detailed information please contact us.

| ELECTRICAL SPECIFICATION - 4G/5G/CBRS (CELLULAR), WI-FI | | | | | | | | |
|---|-----------------------|-----------|-----------|-----------|-----------|-----------|-----------|-----------|
| | LTE 5G | | | | | Wi-Fi | | |
| Operating Frequency (MHz) | 617-698 | 698-960 | 1427-1511 | 1690-4000 | 4000-7125 | 2400-2500 | 4900-6000 | 6000-7125 |
| VSWR - Max* | < 3.0 : 1 | < 2.5 : 1 | < 2.5 : 1 | < 2.0 : 1 | < 2.0 : 1 | < 2.0 : 1 | < 2.0 : 1 | < 2.0 : 1 |
| Isolation (dB) | > 10 | | > 15 | | | > 15 | | |
| Peak Gain - Max (dBi)* | 3.7 | | 2.0 | 4.6 | 3.3 | 3.0 | 4.8 | 2.5 |
| Total Efficiency Average | 70% | | 37% | 63% | 52% | 56% | 59% | 56% |
| Correlation Coefficient | <0.2 | | | | | | | |
| Nominal Impedance (Ohms) | 50 | | | | | | | |
| Input Power Max (W) | 10 | | | | | | | |
| Polarization | Linear Vertical | | | | | | | |
| Azimuth Beamwidth | 360°, Omnidirectional | | | | | | | |

* Measured on 0.6 x 0.6m (2 x 2ft) ground plane with 5m (16ft) low loss cable

| ELECTRICAL SPECIFICATION - GNSS - 1 GNSS PORT MODELS* | | | | |
|---|------------------------|---------|------|---------|
| No. of Ports | 1 | | | |
| Frequency, MHz | L1 Band | | | L5 Band |
| | 1561 | 1575.42 | 1602 | 1176.45 |
| VSWR (Typ.) | 2.0 | 2.1 | 2.0 | 1.6 |
| Patch Peak Gain, dBi | -5.2 | 0.6 | -0.3 | 1.1 |
| LNA Gain, dB | 28 ± 3 | | | |
| Noise Figure, dB | < 3 | | | |
| Input Max Power, dBm | +10 | | | |
| Out of Band Rejection, dBc | 350-520 MHz | | | > 65 |
| | 698-960 MHz | | | > 70 |
| | 1428-1511 MHz | | | > 40 |
| | 1710-2700 MHz | | | > 65 |
| | 4900-5800 MHz | | | > 75 |
| DC Voltage, V | 2 - 5 | | | |
| Current, mA | 12.5 Typ. (at DC 3.0V) | | | |
| Nominal Impedance Ω | 50 | | | |
| Polarization | RHCP | | | |

*Measured on 0.6 x 0.6m (2 x 2ft) ground plane

ELECTRICAL SPECIFICATION - GNSS - 2 GNSS PORT MODELS**

| | | | | |
|----------------------------|------------------------|---------|--------|---------|
| No. of Ports | 2 | | | |
| Frequency, MHz | L1 Band | | | L5 Band |
| | 1561 | 1575.42 | 1602 | 1176.45 |
| VSWR (Typ.) | 1.6 | 1.8 | 1.5 | 1.4 |
| Patch Peak Gain, dBi | 6.4 | 5.8 | 4.8 | 2.2 |
| LNA Gain, dB | 26 ± 3 | | 25 ± 3 | 28 ± 3 |
| Noise Figure, dB | < 3 | | | |
| Input Max Power, dBm | +10 | | | |
| Out of Band Rejection, dBc | 350-520 MHz | | | > 65 |
| | 698-960 MHz | | | > 70 |
| | 1428-1511 MHz | | | > 40 |
| | 1710-2700 MHz | | | > 65 |
| | 4900-5800 MHz | | | > 75 |
| DC Voltage, V | 2 - 5 | | | |
| Current, mA | 12.5 Typ. (at DC 3.0V) | | | |
| Nominal Impedance Ω | 50 | | | |
| Polarization | RHCP | | | |

**Measured on 0.6 x 0.6m (2 x 2ft) ground plane

EXTENSION CABLE ATTENUATION FIGURES - 5MM (0.195 INCH) CABLES

| | | | | | | | |
|-------------------------|---------|-----------|-----------|-----------|-----------|-----------|-----------|
| Frequency Range, MHz | 617-960 | 1427-1511 | 1690-4000 | 4000-7200 | 2400-2500 | 4900-6000 | 6000-7125 |
| Cable Attenuation, dB/m | < 0.3 | < 0.5 | < 0.5 | < 0.9 | < 0.6 | < 1.0 | < 1.1 |

MECHANICAL SPECIFICATION

| | |
|--|--|
| Dimensions - No External Whip Models - LxWxH (mm (in.)) | 245 X 63 X 84 (9.6 X 2.5 X 3.3)* *Not Including External Whip - Height Varies by Whip Model |
| Weight - g (oz.) - Not Including Extension Cables or Whip Antennas | 365-416 (dependent on model) |
| Number of Ports | 6 to 9 Port Options Available |
| Mounting Type | Permanent - Locking Nut |
| Radome | Polycarbonate, UL94-V0 |

ENVIRONMENTAL SPECIFICATION

| | |
|---------------------------------|---|
| Operating Temperature - °C (°F) | -40 to +85 (-40 to +185) |
| Storage Temperature - °C (°F) | -40 to +85 (-40 to +185) |
| Ingress Protection | IP67 |
| UV Rating | ASTM D4674 |
| Flammability Rating | Radome: UL94 V0 Cable: UN ECE R118 |
| Mechanical Shock Rating | IEC 60068-2-27, Secured Cross Country Vehicles |
| Vibration Test Rating | MIL-STD-810G, Method 514.6, Category 4, Highway Truck Vibration |
| Humidity Rating | MIL-STD-810G, 507.5, Procedure II, Aggravated Humidity @ 95% |
| Material Substance Compliance | RoHS Compliant CE & UKCA Compliant - Antenna |

GLOBAL 4G, 5G, CBRS CELLULAR COVERAGE

The **FP20 auto** antenna family provides truly global cellular coverage. The table below shows the frequencies and bands covered and the performance across these bands is shown in the charts below via the corresponding color.

| FREQUENCY | RF BANDS COVERED |
|----------------|--|
| 617-698 MHz | 71 |
| 698-960 MHz | 5, 6, 8, 12, 13, 14, 17, 18, 19, 20, 26, 27, 28, 29, 44, 67, 68, 85 N5, N8, N12, N14, N18, N20, N28, N29, N81, N82, N83, N89, N91, N92, N93, N94 |
| 1427-1511 MHz | 11, 21, 32, 45, 74 N50, N51, N74, N75, N76 |
| 1690-2700 MHz | 1, 2, 3, 4, 7, 9, 10, 15, 16, 23, 25, 30, 33, 34, 35, 36, 37, 38, 39, 40, 41, 65, 66, 69, 70 N30, N34, N38, N39, N40, N41, N65, N66, N70, N80, N84, N86, N90, N95 |
| 3300-4200 MHz | 22, 42, 43, 48 N48, N77, N78 |
| 4400-6000 MHz | N79 |
| 6000-7125 MHz* | 46, 47 N96, N102, N104 |

4G, 5G, CBRS CELLULAR PERFORMANCE

TYPICAL VSWR

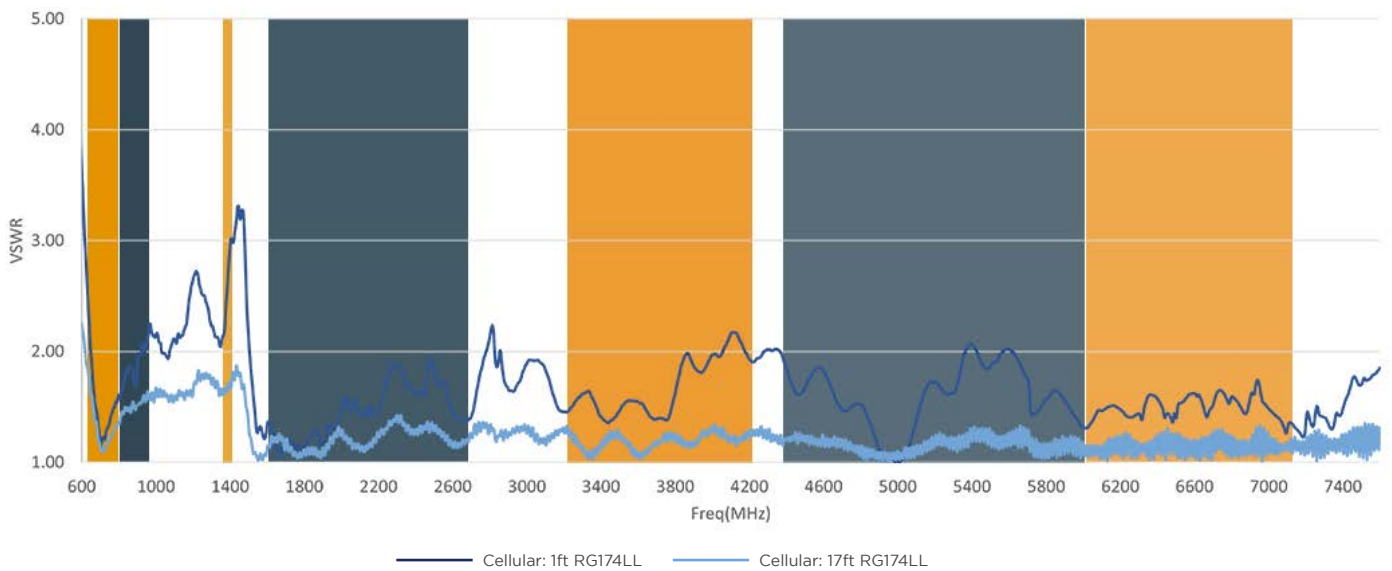

4G, 5G, CBRS CELLULAR PERFORMANCE

GAIN MAX (DBI)

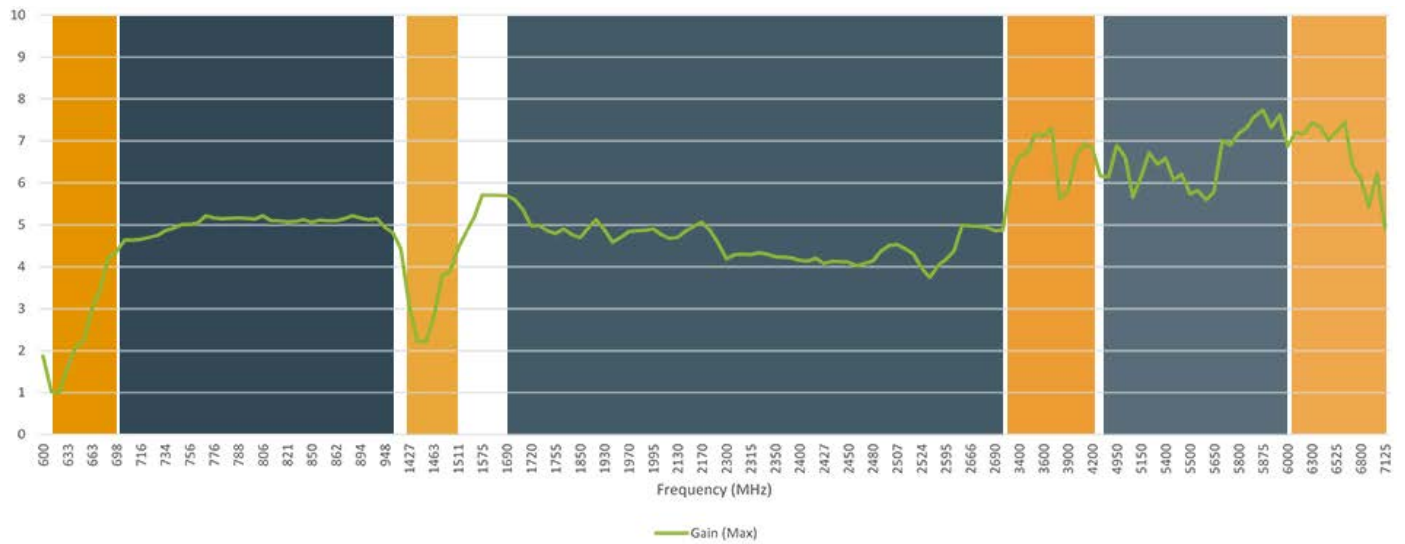

AVERAGE EFFICIENCY %

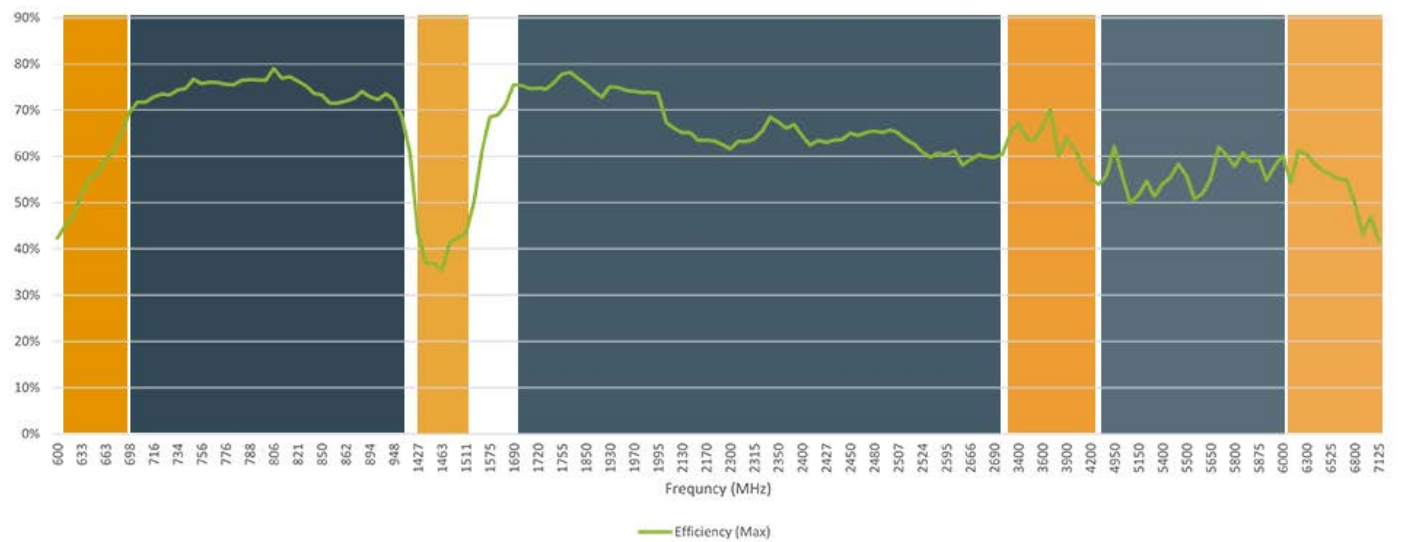

WI-FI AND BLUETOOTH PERFORMANCE

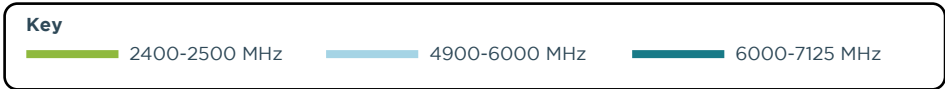

TYPICAL VSWR - WI-FI

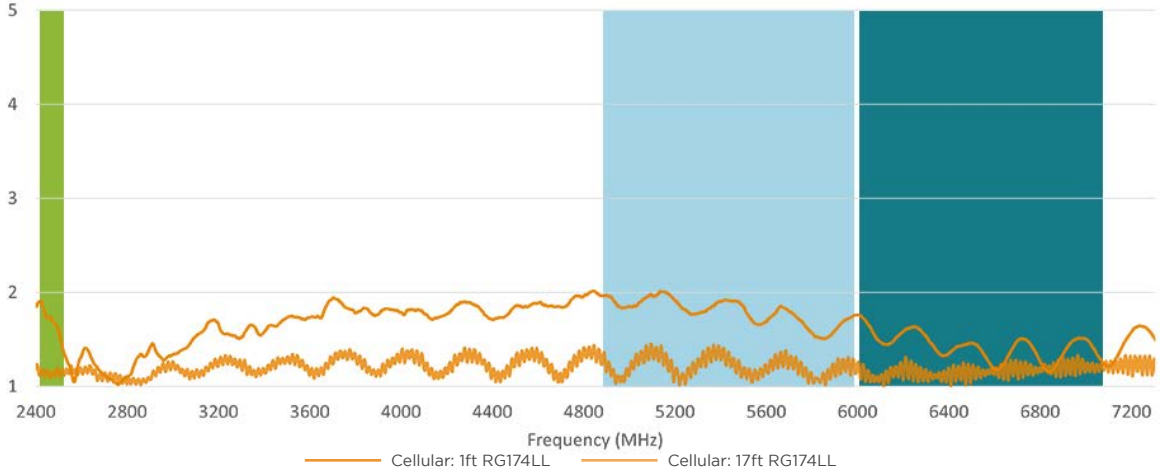

GAIN MAX (DBI) - WI-FI

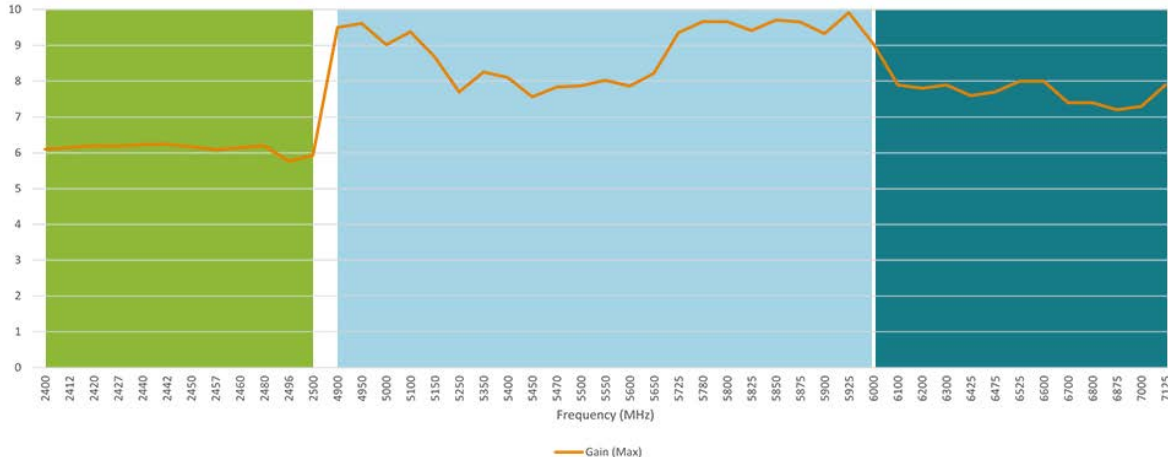

AVERAGE EFFICIENCY - WI-FI

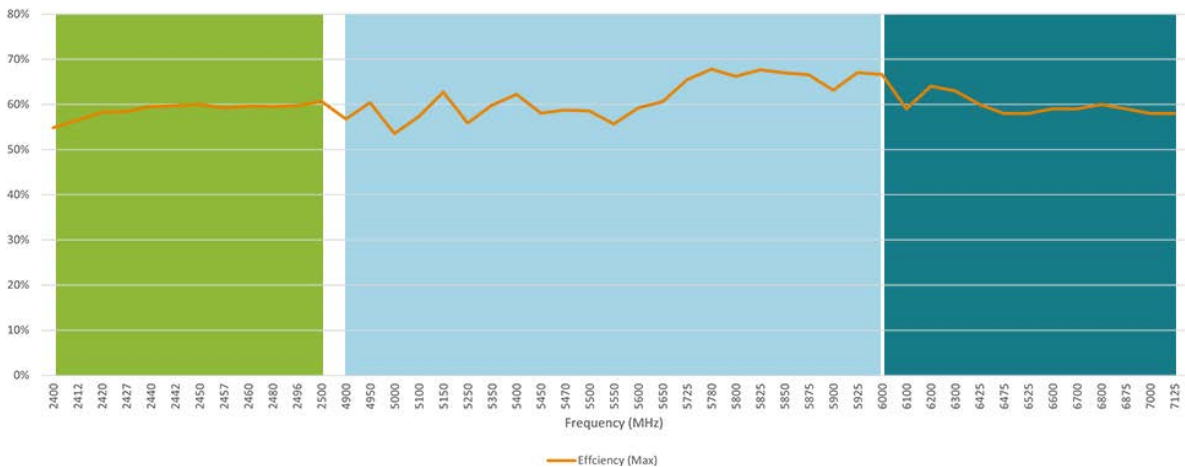

RADIATION PATTERNS

The patterns below are representative of the typical performance of all **FP20 auto** antenna models. Patterns are recorded without the extension cable added and are two element (cellular) or up to four element (Wi-Fi) simulated composite data. Please contact us for full test data. These antennas will perform on and off a ground plane. Performance may vary slightly when no ground plane is used in conjunction with these antennas. If you require test data for both scenarios please get in touch.

4G/5G/CBRS (CELLULAR)

Radiation Patterns at 617 MHz

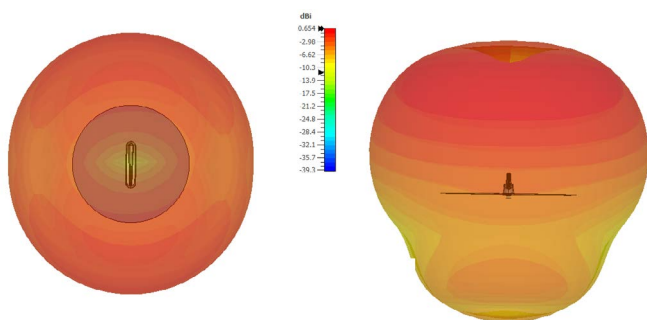

Radiation Patterns at 698 MHz

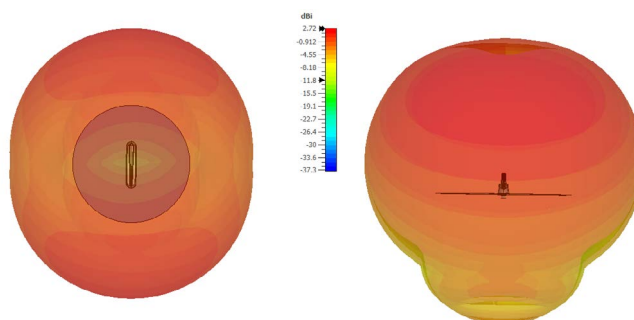

Radiation Patterns at 850 MHz

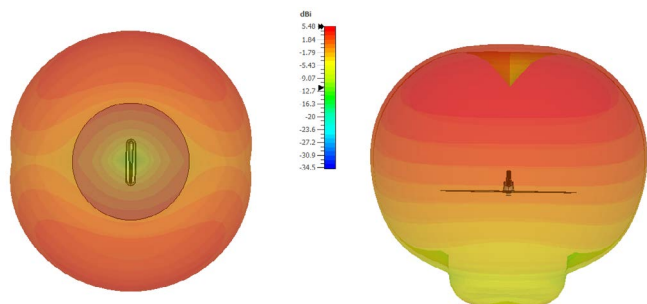

Radiation Patterns at 960 MHz

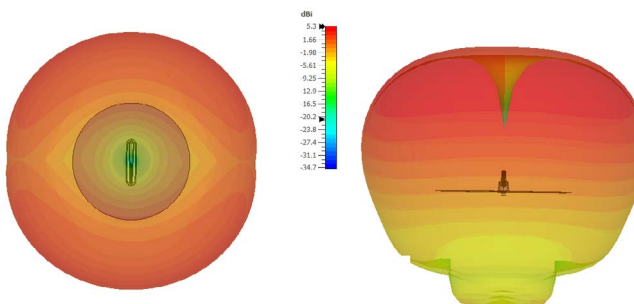

Radiation Patterns at 1500 MHz

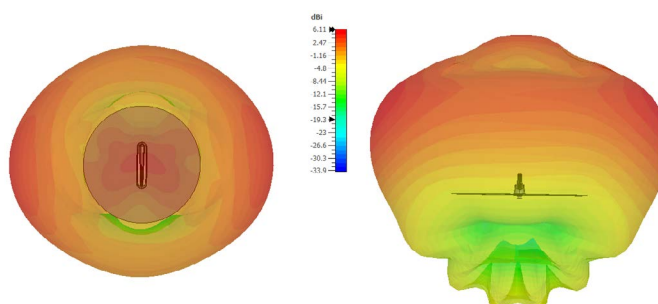

Radiation Patterns at 1690 MHz

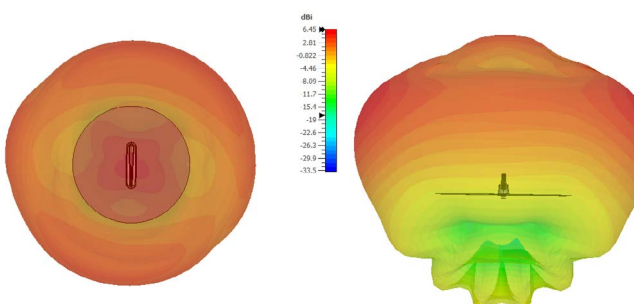

Radiation Patterns at 2170 MHz

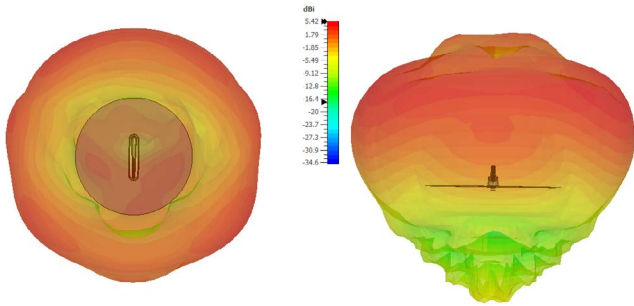

Radiation Patterns at 2500 MHz

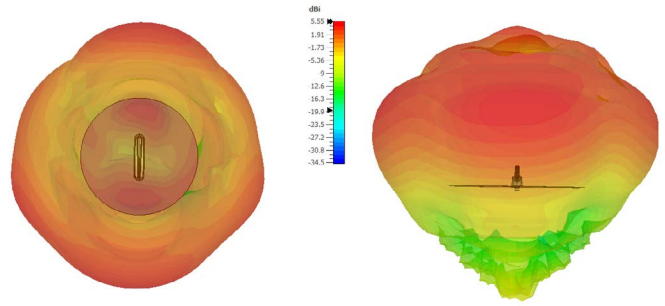

Radiation Patterns at 2700 MHz

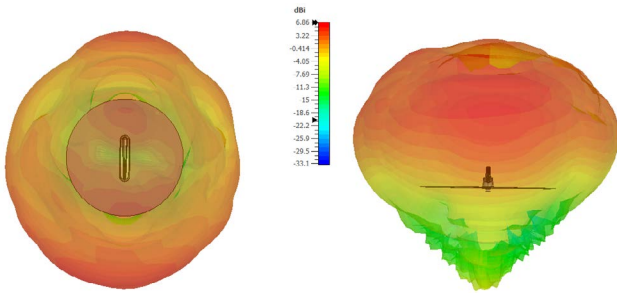

Radiation Patterns at 3500 MHz

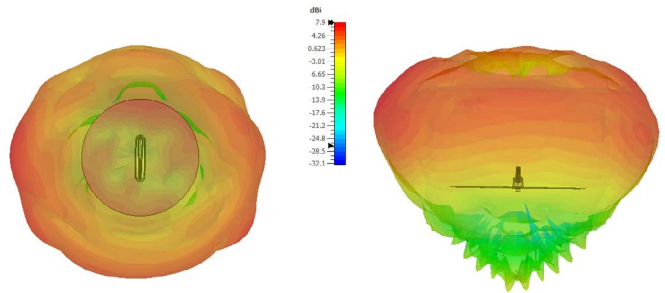

Radiation Patterns at 4900 MHz

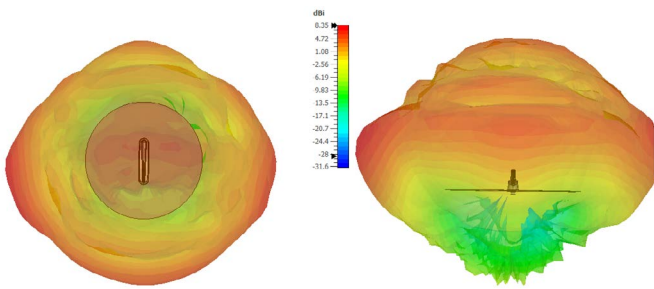

Radiation Patterns at 6000 MHz

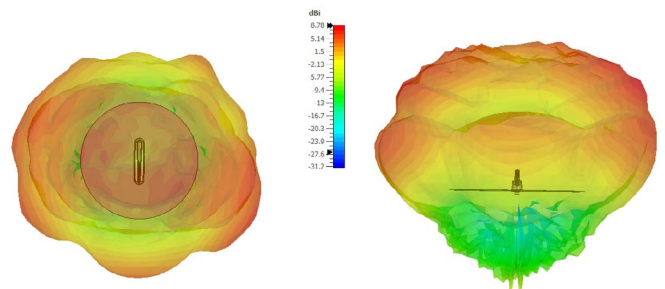

Radiation Patterns at 7125 MHz

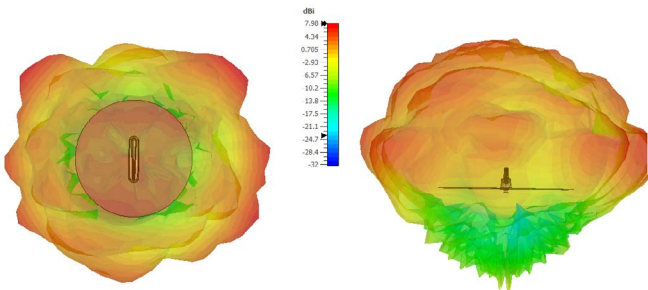

WI-FI & BLUETOOTH

Radiation Patterns at 2400 MHz

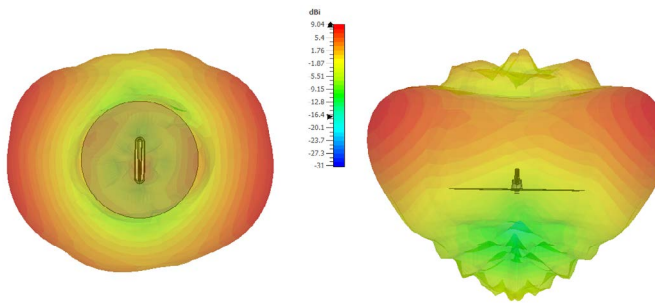

Radiation Patterns at 2450 MHz

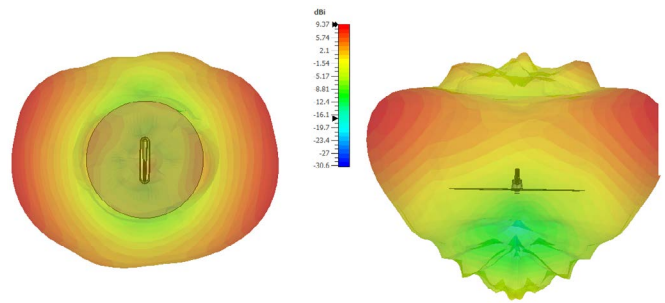

Radiation Patterns at 2500 MHz

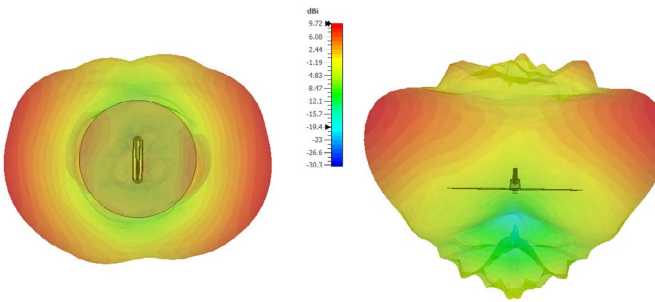

Radiation Patterns at 4900 MHz

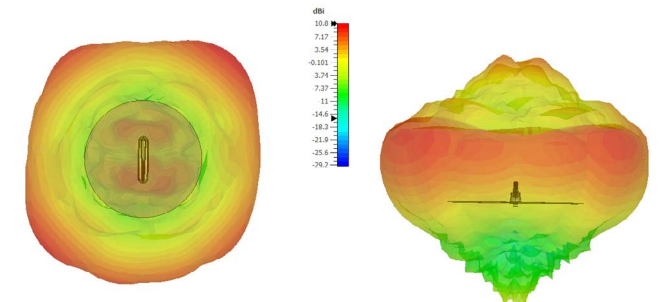

Radiation Patterns at 5500 MHz

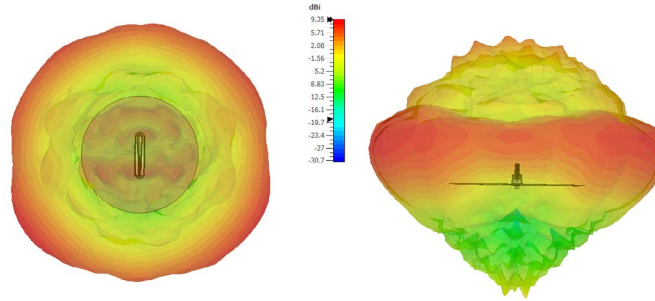

Radiation Patterns at 6000 MHz

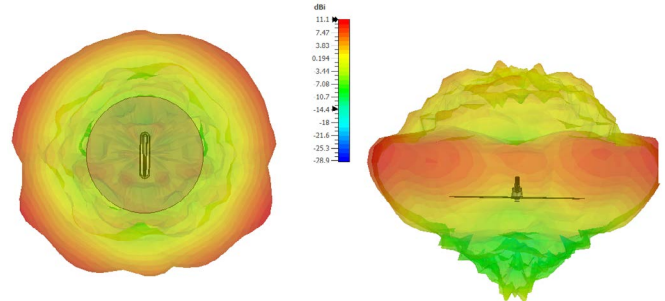

Radiation Patterns at 7125 MHz

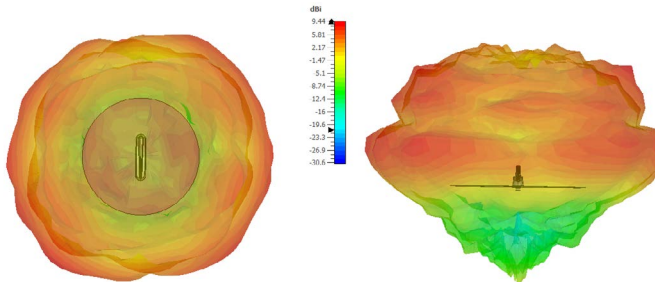

FP20 AUTO: DRAWINGS - SIX PORT

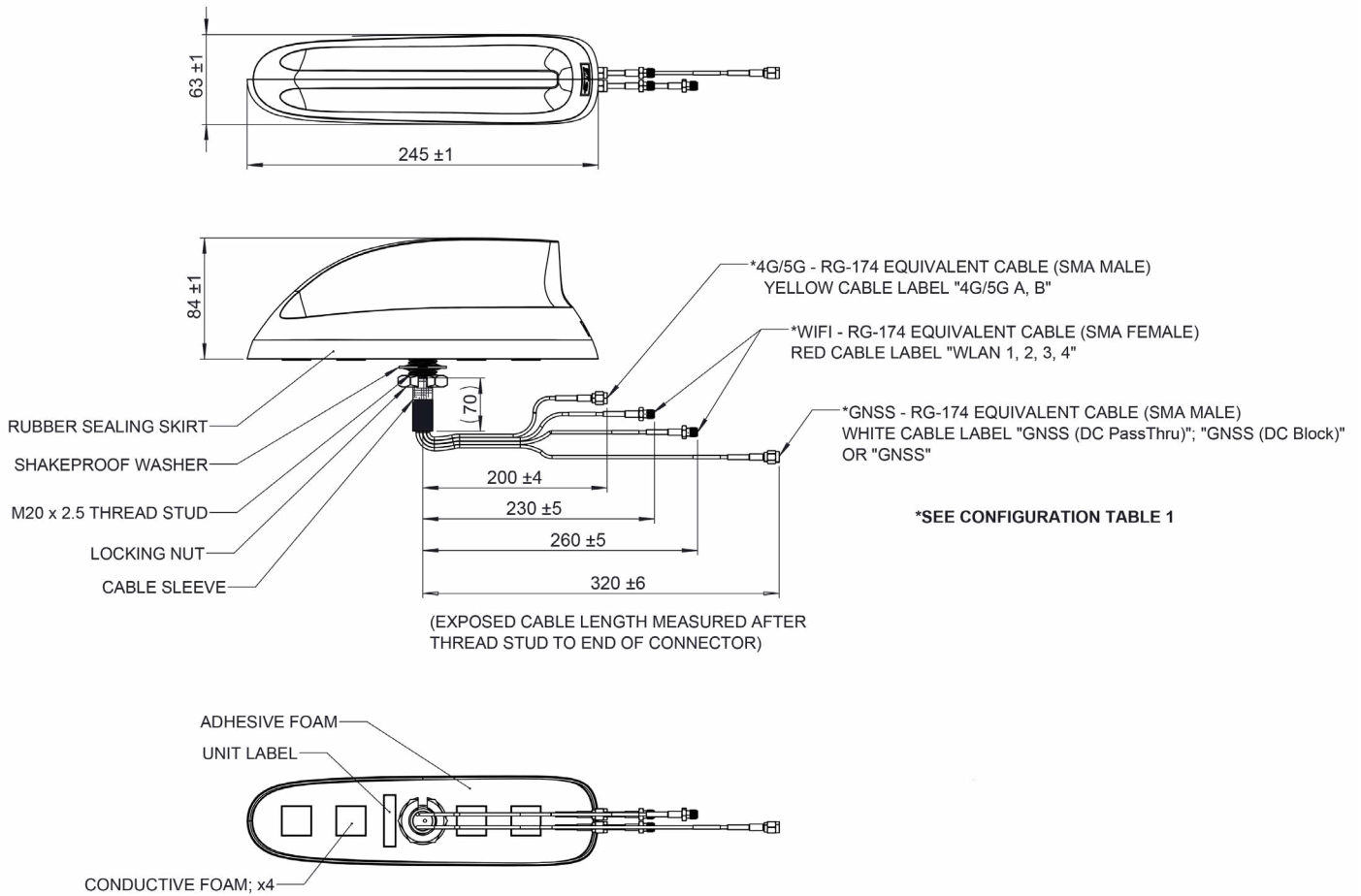

Six Port (No Whip Model)

FP20 AUTO: DRAWINGS - (INC. WHIP MODELS)

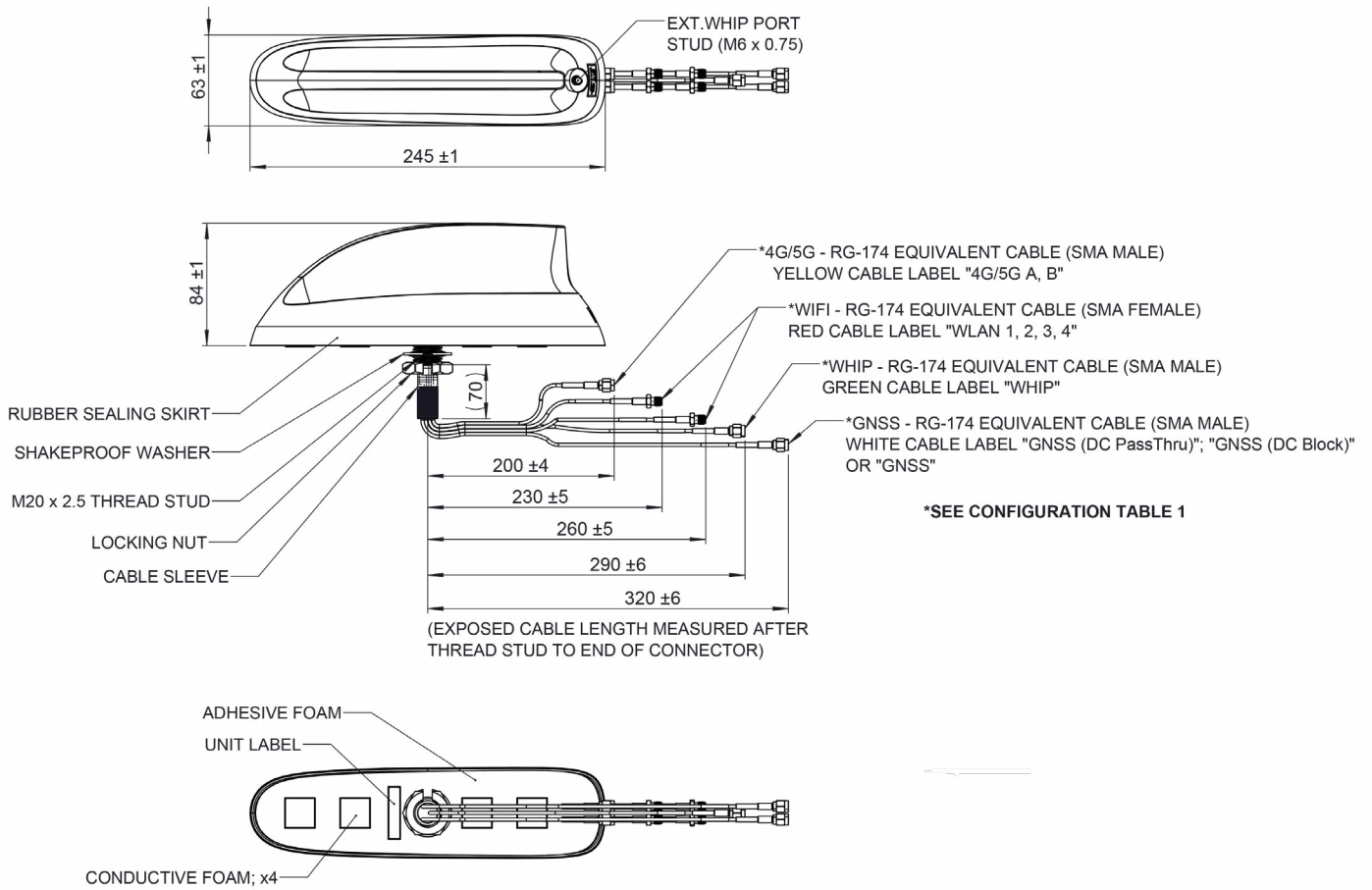

6, 7, 8 & 9 Port (Inc. Whip Models)

FP20 AUTO: DRAWINGS (WITH WHIP)

Illustrative Whip Placement (Tri-Band Whip Shown - Part No. L000340-01)

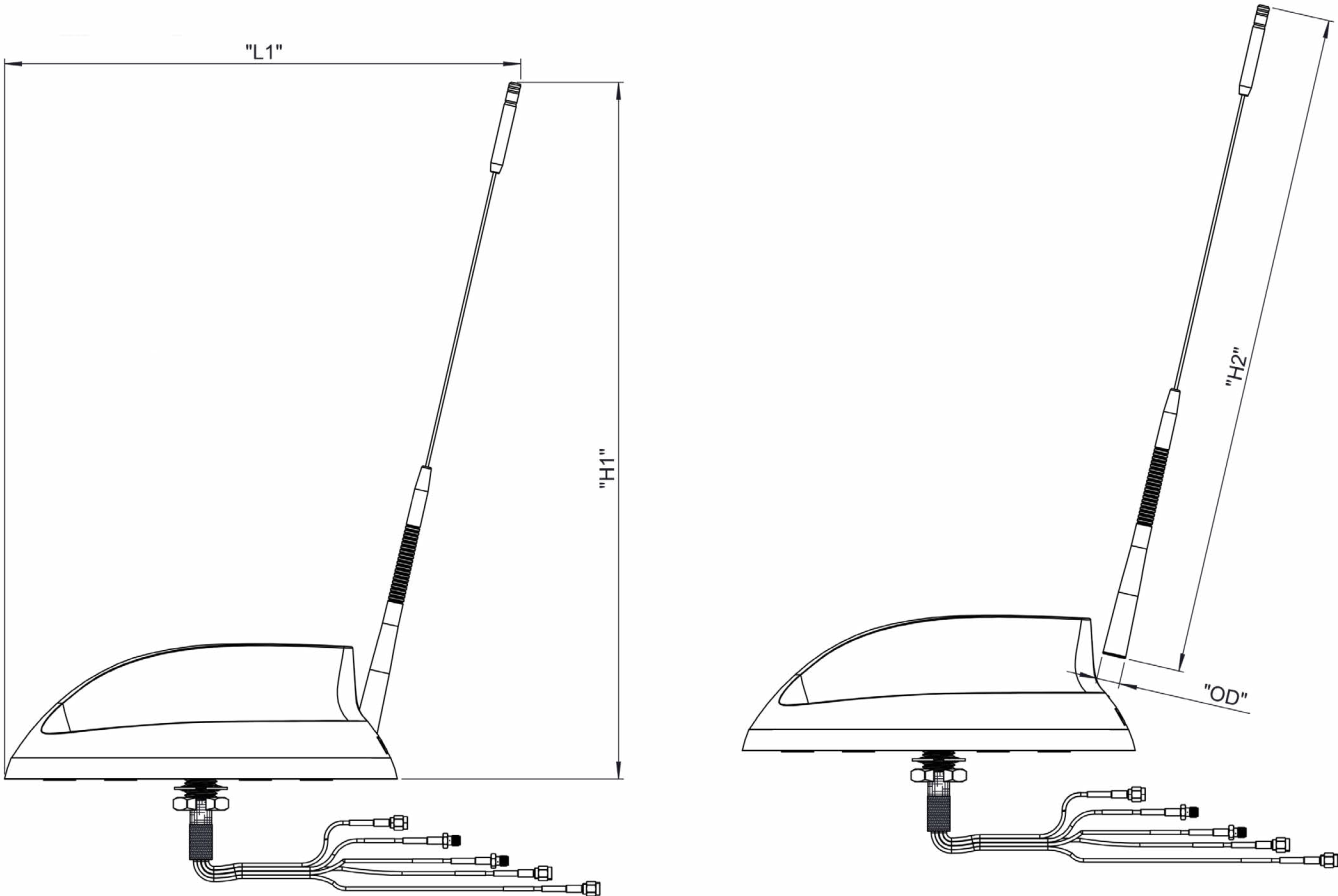

PACKAGING

FP20 auto antennas will be shipped with the appropriate extension cable, in the kit configurations on pages 4-5 of this document. Extension cables will be pre-fitted to the antenna pigtail to reduce installation time.

Air Pallet

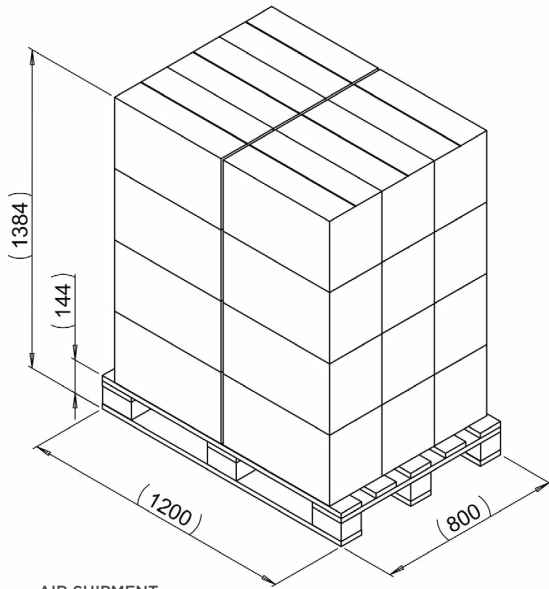

AIR SHIPMENT

- 4 ANTENNAS PER MASTER CARTON
- 6 CARTONS PER LAYER
- 4 LAYERS PER PALLET
- TOTAL ANTENNAS PER PALLET = 96 PCS

Master Carton

4 x ANTENNA WITH EXTENSION CABLE

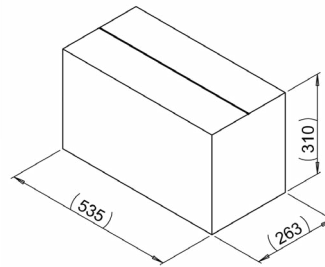

Ocean Pallet

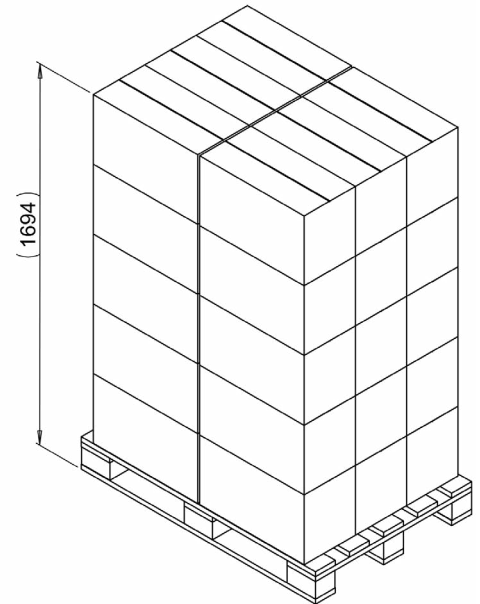

OCEAN SHIPMENT

- 4 ANTENNAS PER MASTER CARTON
- 6 CARTONS PER LAYER
- 5 LAYERS PER PALLET
- TOTAL ANTENNAS PER PALLET = 120 PCS

| Kit Part Number | Description | Estimated Master Carton @ 4 Unit Antenna weight (Kg) | Estimated Full Pallet Weight (Air Shipment)(Kg) | Estimated Full Pallet Weight (Ocean Shipment)(Kg) |
|-----------------|---|--|---|---|
| L000423-01 | 6 Port: 2 x Cellular, 3 x Wi-Fi, 1 x GNSS | 8.3 | 211 | 261 |
| L000423-02 | 7 Port: 2 x Cellular, 2 x Wi-Fi, 2 x GNSS, 1 x Whip | 9.06 | 230 | 284 |
| L000423-03 | 7 Port: 2 x Cellular, 2 x Wi-Fi, 2 x GNSS, 1 x Whip | 9.06 | 230 | 284 |
| L000423-04 | 8 Port: 2 x Cellular, 4 x Wi-Fi, 1 x GNSS, 1 x Whip | 9.9 | 250 | 309 |
| L000423-05 | 9 Port: 2 x Cellular, 4 x Wi-Fi, 2 x GNSS, 1 x Whip | 10.7 | 269 | 333 |
| L000423-06 | 9 Port: 2 x Cellular, 4 x Wi-Fi, 2 x GNSS, 1 x Whip | 10.7 | 269 | 333 |
| L000423-07 | 6 Port: 2 x Cellular, 2 x Wi-Fi, 1 x GNSS, 1 x Whip | 8.3 | 211 | 261 |
| L000423-08 | 5 Port: 2 x Cellular, 2 x Wi-Fi, 1 x GNSS | 7.1 | 183 | 225 |
| L000423-09 | 6 Port: 2 x Cellular, 2 x Wi-Fi, 1 x GNSS, 1 x Whip | 8.3 | 211 | 261 |
| L000423-10 | 5 Port: 2 x Cellular, 2 x Wi-Fi, 1 x GNSS | 7.1 | 183 | 225 |
| L000423-11 | 7 Port: 2 x Cellular, 3 x Wi-Fi, 1 x GNSS, 1 x Whip | 9.06 | 230 | 284 |
| L000423-12 | 8 Port: 2 x Cellular, 3 x Wi-Fi, 2 x GNSS, 1 x Whip | 9.9 | 250 | 309 |
| L000423-13 | 7 Port: 2 x Cellular, 2 x Wi-Fi, 2 x GNSS, 1 x Whip | 9.06 | 230 | 284 |