

L01 Series

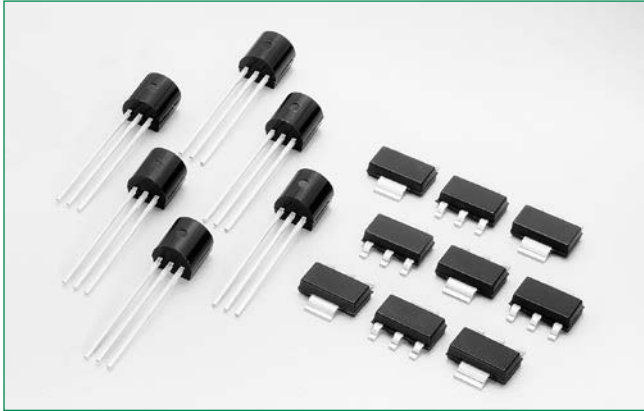

Description

This new 1A bi-directional solid state switch series offers direct interlace to microprocessor drivers in a TO-92 and surface mount packages. The die voltage blocking junctions are glass-passivated to ensure long term reliability and parametric stability.

Features

- RoHS compliant and Halogen-Free
- Blocking voltage (V_{DRM}) capability — up to 800V
- Surge capability > 10Amps
- Static dv/dt > 20 Volts/μsec
- Thru hole and surface mount packages

Main Features

Symbol	Value	Unit
$I_{T(RMS)}$	1	A
V_{DRM}/V_{RRM}	400 to 800	V
I_{GT}	3 to 10	mA

Applications

The L01 EV Series is especially designed for white goods applications such as valve controls in washing machines as well as replacement of mechanical and hybrid relays where long life is required.

Schematic Symbol

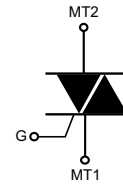

Absolute Maximum Ratings

Symbol	Parameter	Value	Unit	
$I_{T(RMS)}$	RMS on-state current (full sine wave)	TO-92 $T_c = 50^\circ C$	1.0A	A
		SOT-223 $T_L = 90^\circ C$		
I_{TSM}	Non repetitive surge peak on-state current (Single cycle, T_j initial = $25^\circ C$)	TO-92 $F = 50$ Hz	10	A
		SOT-223 $F = 60$ Hz	12	
I^2t	I^2t Value for fusing	$t_p = 10$ ms $F = 50$ Hz	0.50	A ² s
		$t_p = 8.3$ ms $F = 60$ Hz	0.59	
di/dt	Critical rate of rise of on-state current $I_G = 2 \times I_{GT}$	TO-92 $T_j = 125^\circ C$ SOT-223	20	A/μs
I_{GTM}	Peak gate current	$t_p = 10$ μs $T_j = 125^\circ C$	1	A
$P_{G(AV)}$	Average gate power dissipation	$T_j = 125^\circ C$	0.1	W
T_{stg}	Storage junction temperature range		-40 to 150	°C
T_j	Operating junction temperature range		-40 to 125	°C

Electrical Characteristics ($T_J = 25^\circ\text{C}$, unless otherwise specified)

Symbol	Description	Test Conditions	Quadrant	Limit	Value			Unit
					L0103Ny	L0107xy	L0109xy	
I_{GT}	DC Gate Trigger Current	$V_D = 12\text{V}$ $R_L = 60\ \Omega$	I – II – III IV	MIN.	-	-	-	mA
				MAX.	3 5	5 7	10 10	mA
V_{GT}	DC Gate Trigger Voltage		ALL	MAX.	1.3	1.3	1.3	V
I_H	Holding Current	Gate Open		MAX.	7	10	10	mA
dv/dt	Critical Rate-of-Rise of Off-State Voltage	$T_J = 110^\circ\text{C}$ $V_D = V_{DRM}$ Exponential Waveform Gate Open		MIN.	10	20	50	V/ μs
(dv/dt)c	Critical Rate-of-Rise of Commutating Voltage	(di/dt)c = 0.54A/ms $T_J = 110^\circ\text{C}$		MIN.	0.5	1.0	2.0	V/ μs
T_{gt}	Turn-On Time	$I_G = 25\text{mA}$ PW = 15 μs $I_T = 1.2\text{A}$ (pk)		MAX.	2.0	2.0	2.0	μs

Note: x = voltage, y = package

Static Characteristics ($T_J = 25^\circ\text{C}$, unless otherwise specified)

Symbol	Description	Test Conditions	Limit	Value	Unit
V_{TM}	Peak On-State Voltage	$I_{TM} = 1.4\text{A}$ (pk)	MAX	1.60	V
I_{DRM}	Off-State Current, Peak Repetitive	$V_D = V_{DRM}$ $T_J = 25^\circ\text{C}$	MAX	5	μA
		$V_D = V_{DRM}$ $T_J = 125^\circ\text{C}$		500	μA

Thermal Resistances

Symbol	Description	Test Conditions	Value	Unit	
$R_{th(j-c)}$	Junction to case (AC)	$I_T = 1.0\text{A}_{(RMS)}$ ¹	TO-92	50	$^\circ\text{C/W}$
			SOT-223	23	
$R_{th(j-a)}$	Junction to ambient	$I_T = 1.0\text{A}_{(RMS)}$ ¹	TO-92	100	$^\circ\text{C/W}$
			SOT-223	55	

¹ 60Hz AC resistive load condition, 100% conduction.

Figure 1: Definition of Quadrants

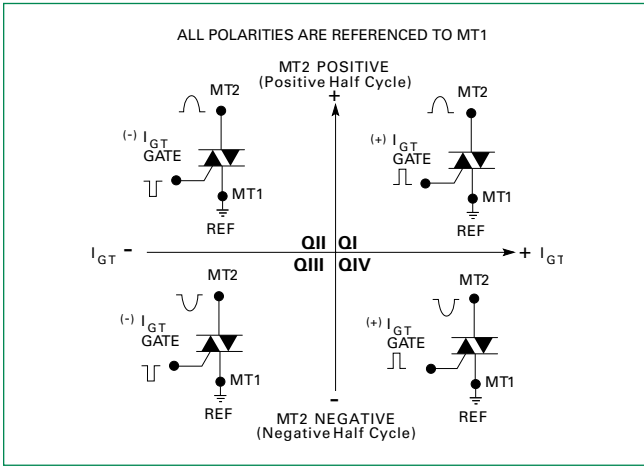

Figure 2: Normalized DC Gate Trigger Current for All Quadrants vs. Junction Temperature

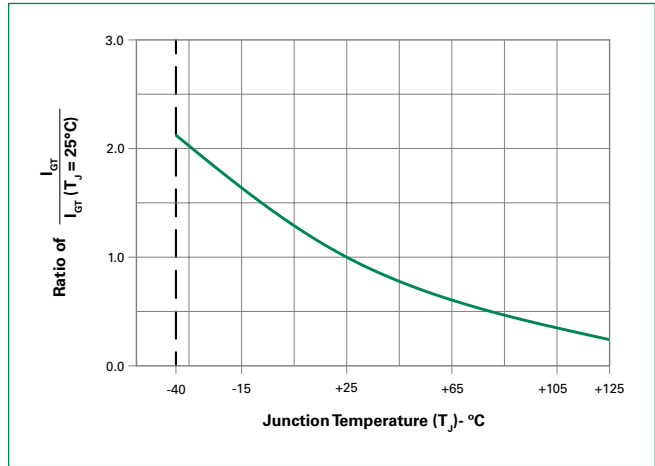

Figure 3: Normalized DC Holding Current vs. Junction Temperature

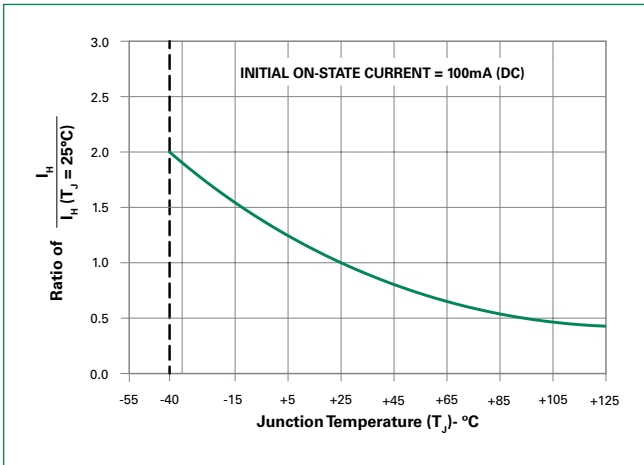

Figure 4: Normalized DC Gate Trigger Voltage for All Quadrants vs. Junction Temperature

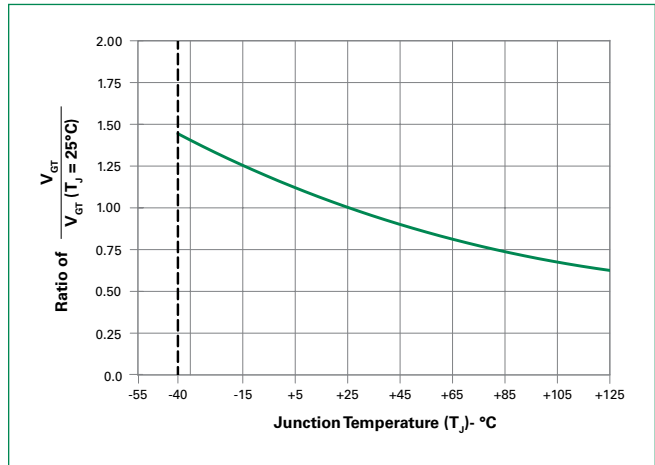

Figure 5: Power Dissipation (Typical) vs. RMS On-State Current

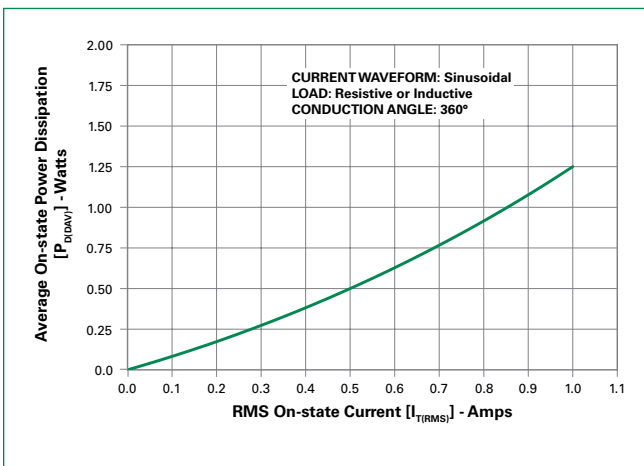

Figure 6: Maximum Allowable Case Temperature vs. On-State Current

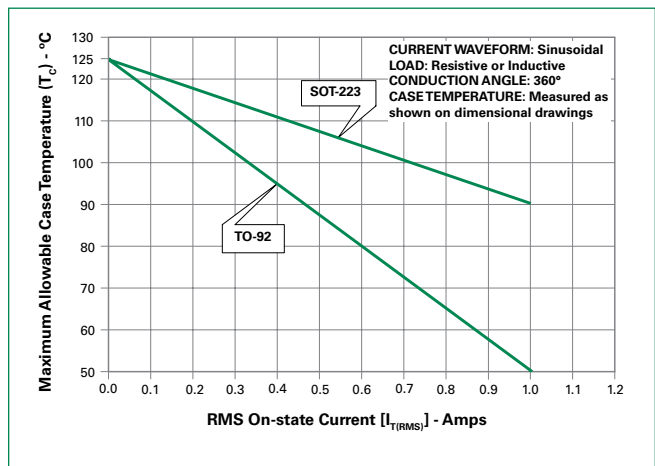
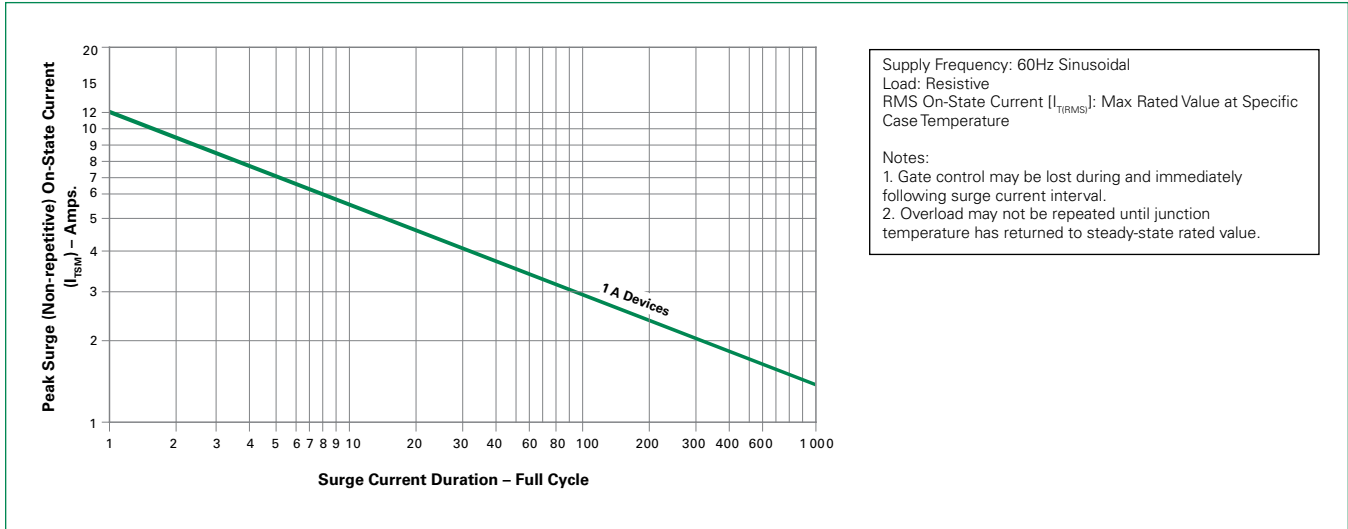
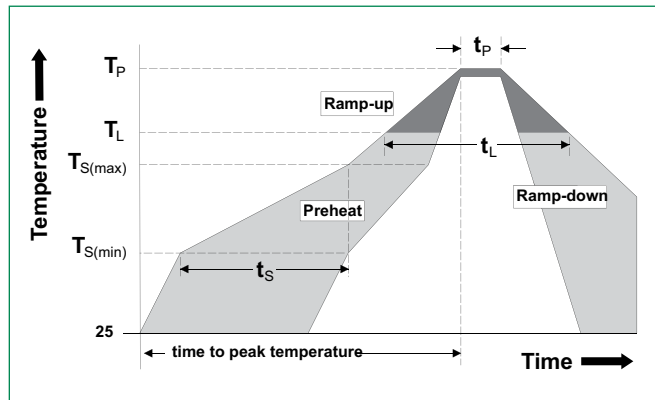

Figure 7: Surge Peak On-State Current vs. Number of Cycles



Soldering Parameters

Reflow Condition		Pb - Free assembly
Pre Heat	- Temperature Min ($T_{s(min)}$)	150°C
	- Temperature Max ($T_{s(max)}$)	200°C
	- Time (min to max) (t_s)	60 - 180 secs
Average ramp up rate (Liquidus Temp) (T_L) to peak		5°C/second max
$T_{s(max)}$ to T_L - Ramp-up Rate		5°C/second max
Reflow	- Temperature (T_L) (Liquidus)	217°C
	- Time (min to max) (t_s)	60 - 150 seconds
Peak Temperature (T_p)		260 ^{+0/-5} °C
Time within 5°C of actual peak Temperature (t_p)		20 - 40 seconds
Ramp-down Rate		5°C/second max
Time 25°C to peak Temperature (T_p)		8 minutes Max.
Do not exceed		280°C



Physical Specifications

Terminal Finish	100% Matte Tin-plated.
Body Material	UL recognized compound meeting flammability rating V-0..
Lead Material	Copper Alloy

Design Considerations

Careful selection of the correct component for the application's operating parameters and environment will go a long way toward extending the operating life of the Thyristor. Good design practice should limit the maximum continuous current through the main terminals to 75% of the component rating. Other ways to ensure long life for a power discrete semiconductor are proper heat sinking and selection of voltage ratings for worst case conditions. Overheating, overvoltage (including dv/dt), and surge currents are the main killers of semiconductors. Correct mounting, soldering, and forming of the leads also help protect against component damage.

Environmental Specifications

Test	Specifications and Conditions
AC Blocking	MIL-STD-750, M-1040, Cond A Applied Peak AC voltage @ 125°C for 1008 hours
Temperature Cycling	MIL-STD-750, M-1051, 100 cycles; -40°C to +150°C; 15-min dwell-time
Temperature/Humidity	EIA / JEDEC, JESD22-A101 1008 hours; 320V - DC: 85°C; 85% rel humidity
High Temp Storage	MIL-STD-750, M-1031, 1008 hours; 150°C
Low-Temp Storage	1008 hours; -40°C
Resistance to Solder Heat	MIL-STD-750 Method 2031
Solderability	ANSI/J-STD-002, category 3, Test A
Lead Bend	MIL-STD-750, M-2036 Cond E

Dimensions — TO-92 (E Package)

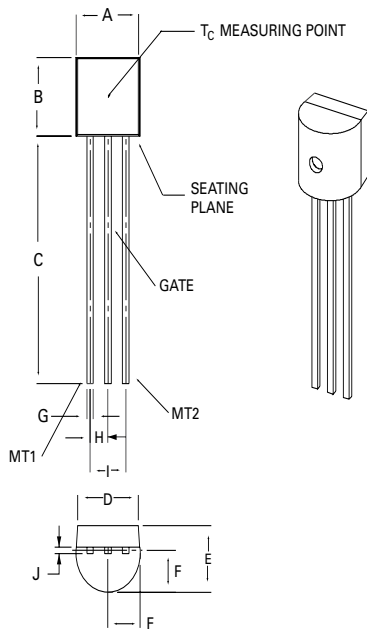

Dimensions	Inches		Millimeters	
	Min	Max	Min	Max
A	0.175	0.205	4.450	5.200
B	0.170	0.210	4.320	5.330
C	0.500		12.70	
D	0.135		3.430	
E	0.125	0.165	3.180	4.190
F	0.080	0.105	2.040	2.660
G	0.016	0.021	0.407	0.533
H	0.045	0.055	1.150	1.390
I	0.095	0.105	2.420	2.660
J	0.015	0.020	0.380	0.500

Dimensions – SOT-223

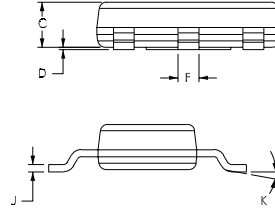
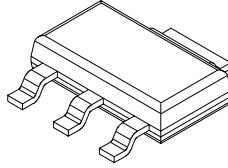
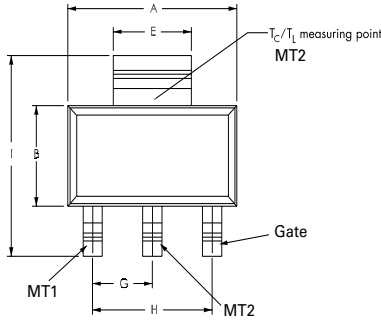

Pad Layout for SOT-223

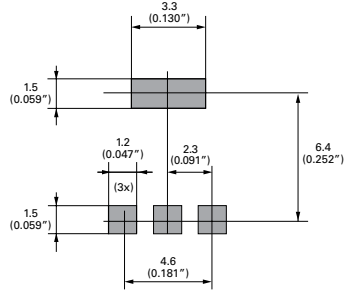

Dimensions in Millimeters (Inches)

Dimensions	Inches			Millimeters		
	Min	Typ	Max	Min	Typ	Max
A	0.248	0.256	0.264	6.30	6.50	6.70
B	0.130	0.138	0.146	3.30	3.50	3.70
C	—	—	0.071	—	—	1.80
D	0.001	—	0.004	0.02	—	0.10
E	0.114	0.118	0.124	2.90	3.00	3.15
F	0.024	0.027	0.034	0.60	0.70	0.85
G	—	0.090	—	—	2.30	—
H	—	0.181	—	—	4.60	—
I	0.264	0.276	0.287	6.70	7.00	7.30
J	0.009	0.010	0.014	0.24	0.26	0.35
K	10° MAX					

Product Selector

Part Number	Voltage	Gate Sensitivity Quadrants		Package
		I II III	IV	
L0103DE	400 V	3 mA	5 mA	TO-92
L0103ME	600 V	3 mA	5 mA	TO-92
L0103NE	800 V	3 mA	7 mA	TO-92
L0103DT	400 V	3 mA	5 mA	SOT-223
L0103MT	600 V	3 mA	5 mA	SOT-223
L0103NT	800 V	3 mA	7 mA	SOT-223
L0107DE	400 V	5 mA	7 mA	TO-92
L0107ME	600 V	5 mA	7 mA	TO-92
L0107NE	800 V	5 mA	7 mA	TO-92
L0107DT	400 V	5 mA	7 mA	SOT-223
L0107MT	600 V	5 mA	7 mA	SOT-233
L0107NT	800 V	5 mA	7 mA	SOT-233
L0109DE	400 V	10 mA	10 mA	TO-92
L0109ME	600 V	10 mA	10 mA	TO-92
L0109NE	800 V	10 mA	10 mA	TO-92
L0109DT	400 V	10 mA	10 mA	SOT-223
L0109MT	600 V	10 mA	10 mA	SOT-223
L0109NT	800 V	10 mA	10 mA	SOT-223

Packing Options

Part Number	Marking	Weight	Packing Mode	Base Quantity
L01xxyE	L01xxyE	0.217 g	Bulk	2500
L01xxyEAP	L01xxyE	0.217 g	Ammo Pack	2000
L01xxyERP	L01xxyE	0.217 g	Tape & Reel	2000
L01xxyTRP	L01xxyT	0.120 g	Tape & Reel	1000

Note: xx = gate sensitivity, y = voltage

TO-92 (3-lead) Reel Pack (RP) Radial Led Specifications

Meets all EIA-468-C Standards

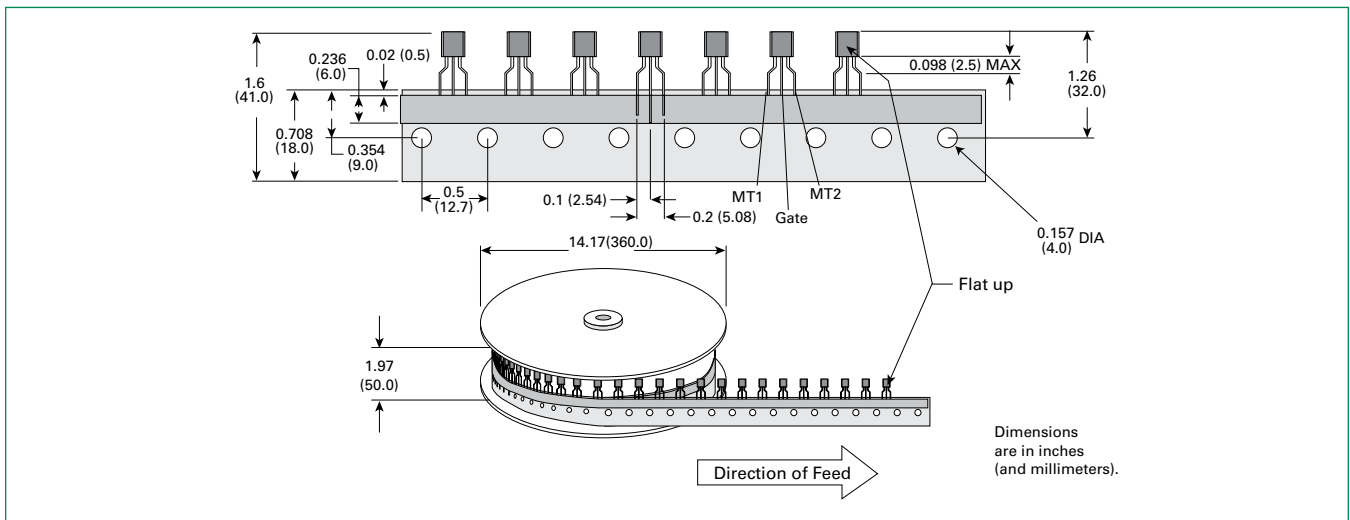

TO-92 (3-lead) Ammo Pack (AP) Radial Led Specifications

Meets all EIA-468-C Standards

