

L01 Series



Description

This new 1A bi-directional solid state switch series offers direct interlace to microprocessor drivers in a TO-92 and surface mount packages. The die voltage blocking junctions are glass-passivated to ensure long term reliability and parametric stability.

Features

- RoHS compliant and Halogen-Free
- Blocking voltage (V_{DRM}) capability — up to 800V
- Surge capability > 10Amps
- Static dv/dt > 20 Volts/μsec
- Thru hole and surface mount packages

Main Features

| Symbol | Value | Unit |
|-------------------|------------|------|
| $I_{T(RMS)}$ | 1 | A |
| V_{DRM}/V_{RRM} | 400 to 800 | V |
| I_{GT} | 3 to 10 | mA |

Applications

The L01 EV Series is especially designed for white goods applications such as valve controls in washing machines as well as replacement of mechanical and hybrid relays where long life is required.

Schematic Symbol

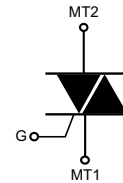

Absolute Maximum Ratings

| Symbol | Parameter | Value | Unit | |
|--------------|---|--------------------------------------|------------|------------------|
| $I_{T(RMS)}$ | RMS on-state current (full sine wave) | TO-92 $T_c = 50^\circ C$ | 1.0A | A |
| | | SOT-223 $T_L = 90^\circ C$ | | |
| I_{TSM} | Non repetitive surge peak on-state current (Single cycle, T_j initial = 25°C) | TO-92 $F = 50$ Hz | 10 | A |
| | | SOT-223 $F = 60$ Hz | 12 | |
| I^2t | I^2t Value for fusing | $t_p = 10$ ms $F = 50$ Hz | 0.50 | A ² s |
| | | $t_p = 8.3$ ms $F = 60$ Hz | 0.59 | |
| di/dt | Critical rate of rise of on-state current $I_G = 2 \times I_{GT}$ | TO-92 $T_j = 125^\circ C$ SOT-223 | 20 | A/μs |
| I_{GTM} | Peak gate current | $t_p = 10$ μs $T_j = 125^\circ C$ | 1 | A |
| $P_{G(AV)}$ | Average gate power dissipation | $T_j = 125^\circ C$ | 0.1 | W |
| T_{stg} | Storage junction temperature range | | -40 to 150 | °C |
| T_j | Operating junction temperature range | | -40 to 125 | °C |

Electrical Characteristics ($T_J = 25^\circ\text{C}$, unless otherwise specified)

| Symbol | Description | Test Conditions | Quadrant | Limit | Value | | | Unit |
|----------|--|---|--------------------|-------|---------|---------|----------|------------------|
| | | | | | L0103Ny | L0107xy | L0109xy | |
| I_{GT} | DC Gate Trigger Current | $V_D = 12\text{V}$ $R_L = 60\ \Omega$ | I – II – III IV | MIN. | - | - | - | mA |
| | | | | MAX. | 3 5 | 5 7 | 10 10 | mA |
| V_{GT} | DC Gate Trigger Voltage | | ALL | MAX. | 1.3 | 1.3 | 1.3 | V |
| I_H | Holding Current | Gate Open | | MAX. | 7 | 10 | 10 | mA |
| dv/dt | Critical Rate-of-Rise of Off-State Voltage | $T_J = 110^\circ\text{C}$ $V_D = V_{DRM}$ Exponential Waveform Gate Open | | MIN. | 10 | 20 | 50 | V/ μs |
| (dv/dt)c | Critical Rate-of-Rise of Commutating Voltage | (di/dt)c = 0.54A/ms $T_J = 110^\circ\text{C}$ | | MIN. | 0.5 | 1.0 | 2.0 | V/ μs |
| T_{gt} | Turn-On Time | $I_G = 25\text{mA}$ PW = 15 μs $I_T = 1.2\text{A}$ (pk) | | MAX. | 2.0 | 2.0 | 2.0 | μs |

Note: x = voltage, y = package

Static Characteristics ($T_J = 25^\circ\text{C}$, unless otherwise specified)

| Symbol | Description | Test Conditions | Limit | Value | Unit |
|-----------|------------------------------------|---|-------|-------|---------------|
| V_{TM} | Peak On-State Voltage | $I_{TM} = 1.4\text{A}$ (pk) | MAX | 1.60 | V |
| I_{DRM} | Off-State Current, Peak Repetitive | $V_D = V_{DRM}$ $T_J = 25^\circ\text{C}$ | MAX | 5 | μA |
| | | $V_D = V_{DRM}$ $T_J = 125^\circ\text{C}$ | | 500 | μA |

Thermal Resistances

| Symbol | Description | Test Conditions | Value | Unit | |
|---------------|-----------------------|--|---------|------|--------------------|
| $R_{th(j-c)}$ | Junction to case (AC) | $I_T = 1.0\text{A}_{(RMS)}$ ¹ | TO-92 | 50 | $^\circ\text{C/W}$ |
| | | | SOT-223 | 23 | |
| $R_{th(j-a)}$ | Junction to ambient | $I_T = 1.0\text{A}_{(RMS)}$ ¹ | TO-92 | 100 | $^\circ\text{C/W}$ |
| | | | SOT-223 | 55 | |

¹ 60Hz AC resistive load condition, 100% conduction.

Figure 1: Definition of Quadrants

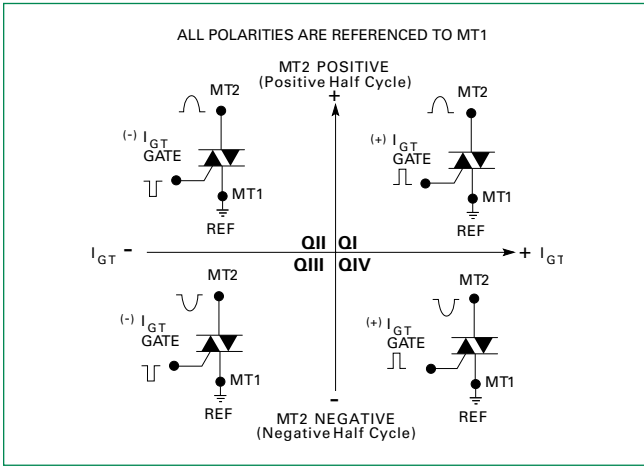

Figure 2: Normalized DC Gate Trigger Current for All Quadrants vs. Junction Temperature

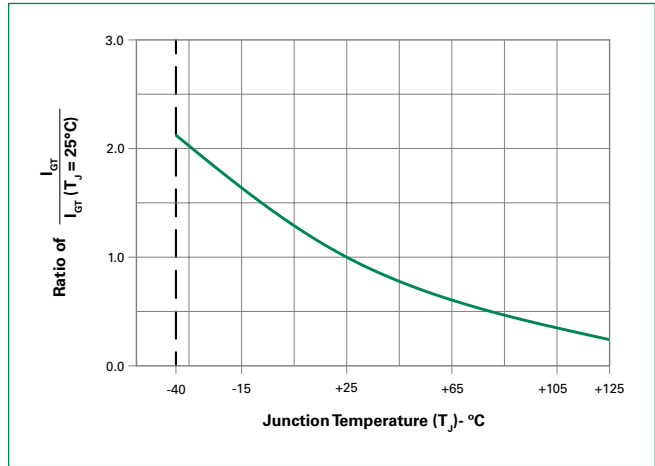

Figure 3: Normalized DC Holding Current vs. Junction Temperature

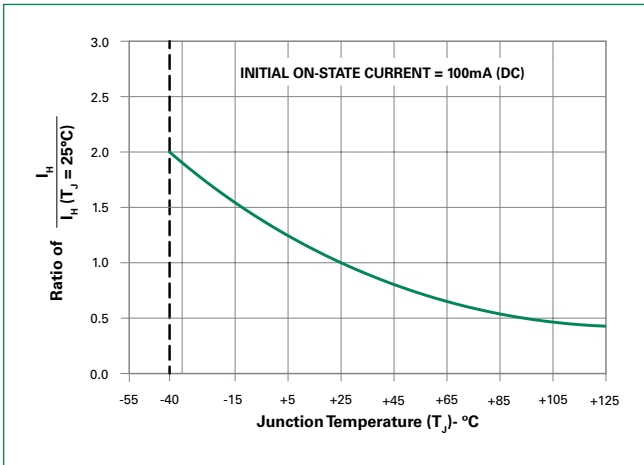

Figure 4: Normalized DC Gate Trigger Voltage for All Quadrants vs. Junction Temperature

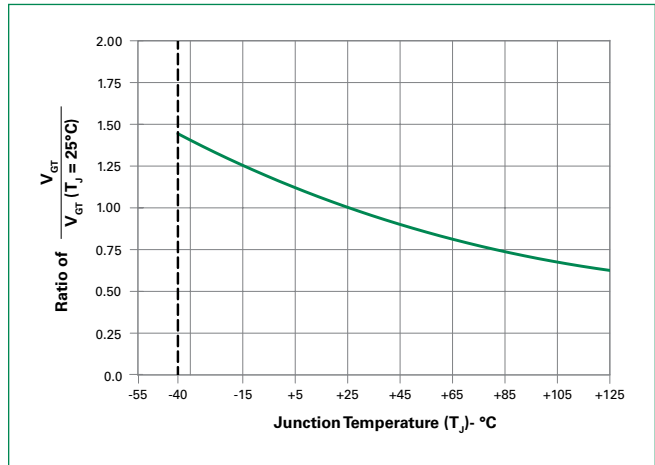

Figure 5: Power Dissipation (Typical) vs. RMS On-state Current

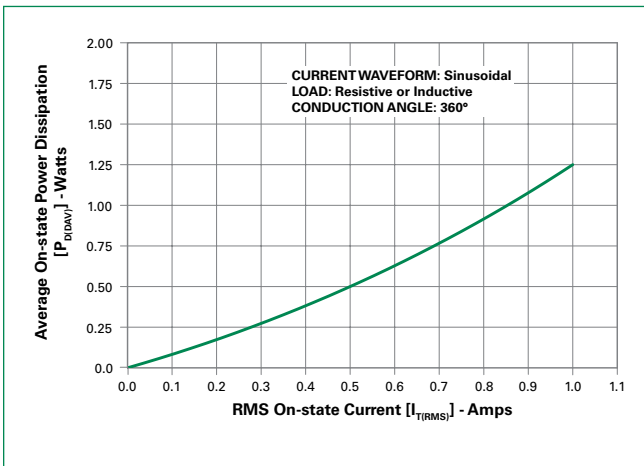

Figure 6: Maximum Allowable Case Temperature vs. On-state Current

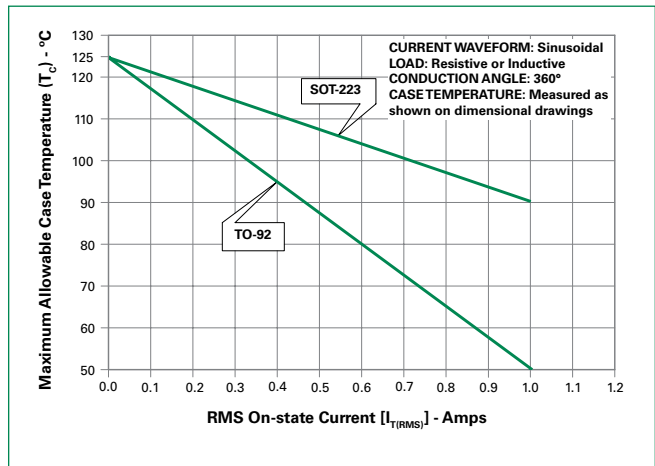
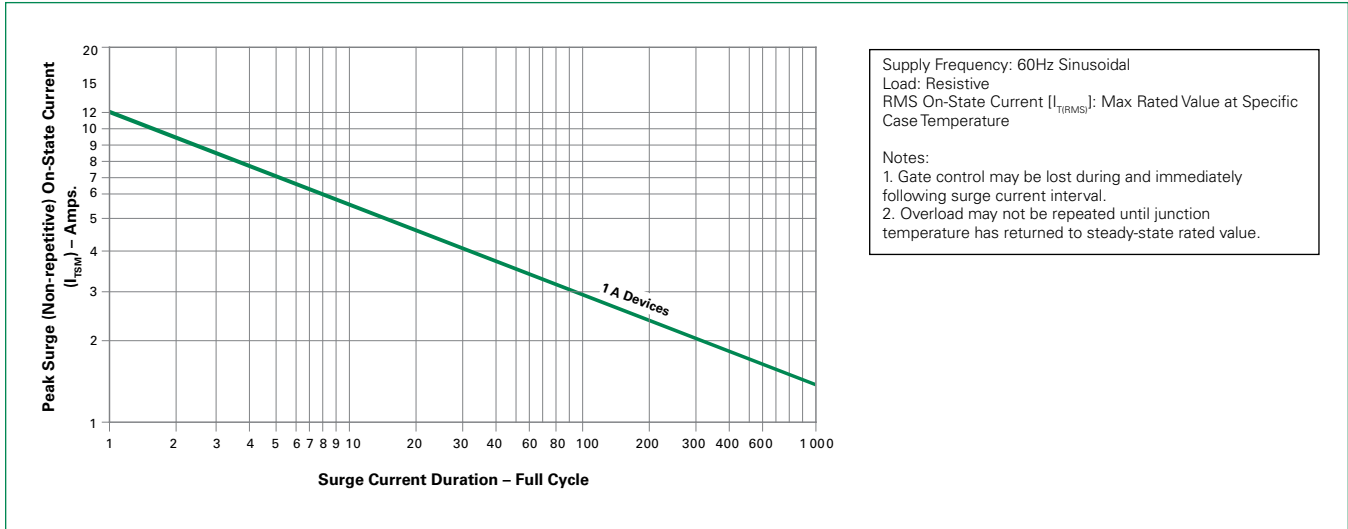
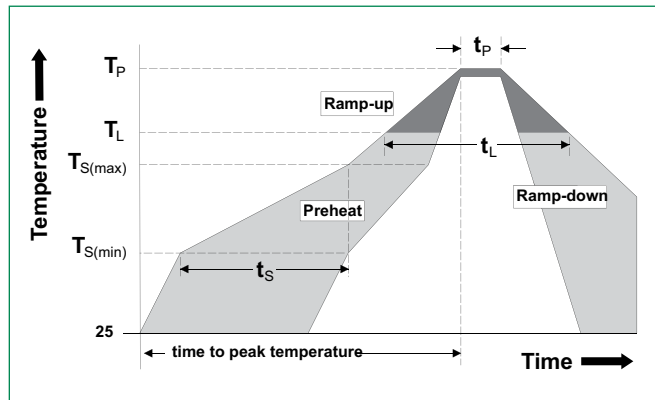

Figure 7: Surge Peak On-State Current vs. Number of Cycles



Soldering Parameters

| | | |
|--|------------------------------------|-------------------------|
| Reflow Condition | | Pb - Free assembly |
| Pre Heat | - Temperature Min ($T_{s(min)}$) | 150°C |
| | - Temperature Max ($T_{s(max)}$) | 200°C |
| | - Time (min to max) (t_s) | 60 - 180 secs |
| Average ramp up rate (Liquidus Temp) (T_L) to peak | | 5°C/second max |
| $T_{s(max)}$ to T_L - Ramp-up Rate | | 5°C/second max |
| Reflow | - Temperature (T_L) (Liquidus) | 217°C |
| | - Time (min to max) (t_s) | 60 - 150 seconds |
| Peak Temperature (T_p) | | 260 ^{+0/-5} °C |
| Time within 5°C of actual peak Temperature (t_p) | | 20 - 40 seconds |
| Ramp-down Rate | | 5°C/second max |
| Time 25°C to peak Temperature (T_p) | | 8 minutes Max. |
| Do not exceed | | 280°C |



Physical Specifications

| | |
|------------------------|--|
| Terminal Finish | 100% Matte Tin-plated. |
| Body Material | UL recognized compound meeting flammability rating V-0.. |
| Lead Material | Copper Alloy |

Design Considerations

Careful selection of the correct component for the application's operating parameters and environment will go a long way toward extending the operating life of the Thyristor. Good design practice should limit the maximum continuous current through the main terminals to 75% of the component rating. Other ways to ensure long life for a power discrete semiconductor are proper heat sinking and selection of voltage ratings for worst case conditions. Overheating, overvoltage (including dv/dt), and surge currents are the main killers of semiconductors. Correct mounting, soldering, and forming of the leads also help protect against component damage.

Environmental Specifications

| Test | Specifications and Conditions |
|----------------------------------|--|
| AC Blocking | MIL-STD-750, M-1040, Cond A Applied Peak AC voltage @ 125°C for 1008 hours |
| Temperature Cycling | MIL-STD-750, M-1051, 100 cycles; -40°C to +150°C; 15-min dwell-time |
| Temperature/Humidity | EIA / JEDEC, JESD22-A101 1008 hours; 320V - DC: 85°C; 85% rel humidity |
| High Temp Storage | MIL-STD-750, M-1031, 1008 hours; 150°C |
| Low-Temp Storage | 1008 hours; -40°C |
| Resistance to Solder Heat | MIL-STD-750 Method 2031 |
| Solderability | ANSI/J-STD-002, category 3, Test A |
| Lead Bend | MIL-STD-750, M-2036 Cond E |

Dimensions — TO-92 (E Package)

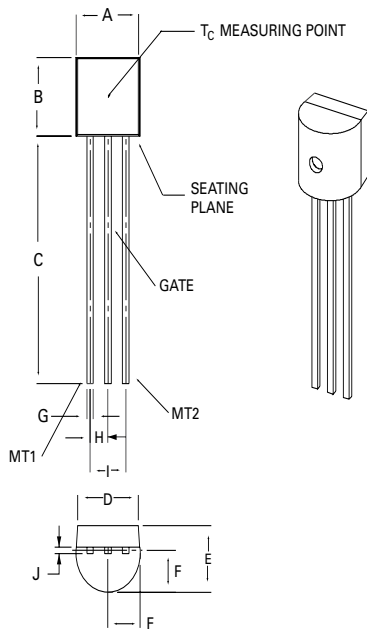

| Dimensions | Inches | | Millimeters | |
|------------|--------|-------|-------------|-------|
| | Min | Max | Min | Max |
| A | 0.175 | 0.205 | 4.450 | 5.200 |
| B | 0.170 | 0.210 | 4.320 | 5.330 |
| C | 0.500 | | 12.70 | |
| D | 0.135 | | 3.430 | |
| E | 0.125 | 0.165 | 3.180 | 4.190 |
| F | 0.080 | 0.105 | 2.040 | 2.660 |
| G | 0.016 | 0.021 | 0.407 | 0.533 |
| H | 0.045 | 0.055 | 1.150 | 1.390 |
| I | 0.095 | 0.105 | 2.420 | 2.660 |
| J | 0.015 | 0.020 | 0.380 | 0.500 |

Dimensions – SOT-223

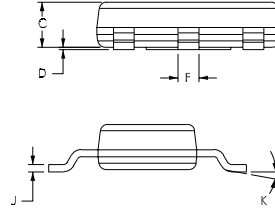
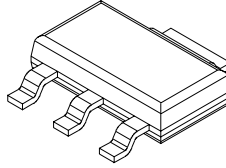
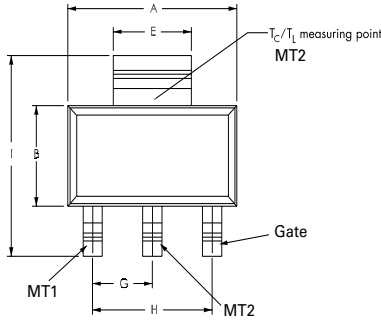

Pad Layout for SOT-223

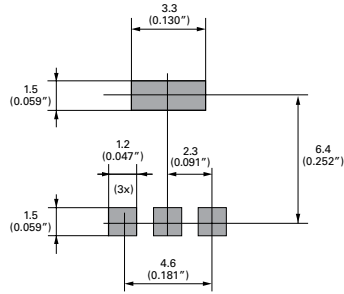

Dimensions in Millimeters (Inches)

| Dimensions | Inches | | | Millimeters | | |
|------------|---------|-------|-------|-------------|------|------|
| | Min | Typ | Max | Min | Typ | Max |
| A | 0.248 | 0.256 | 0.264 | 6.30 | 6.50 | 6.70 |
| B | 0.130 | 0.138 | 0.146 | 3.30 | 3.50 | 3.70 |
| C | — | — | 0.071 | — | — | 1.80 |
| D | 0.001 | — | 0.004 | 0.02 | — | 0.10 |
| E | 0.114 | 0.118 | 0.124 | 2.90 | 3.00 | 3.15 |
| F | 0.024 | 0.027 | 0.034 | 0.60 | 0.70 | 0.85 |
| G | — | 0.090 | — | — | 2.30 | — |
| H | — | 0.181 | — | — | 4.60 | — |
| I | 0.264 | 0.276 | 0.287 | 6.70 | 7.00 | 7.30 |
| J | 0.009 | 0.010 | 0.014 | 0.24 | 0.26 | 0.35 |
| K | 10° MAX | | | | | |

Product Selector

| Part Number | Voltage | Gate Sensitivity Quadrants | | Package |
|-------------|---------|----------------------------|-------|---------|
| | | I II III | IV | |
| L0103DE | 400 V | 3 mA | 5 mA | TO-92 |
| L0103ME | 600 V | 3 mA | 5 mA | TO-92 |
| L0103NE | 800 V | 3 mA | 7 mA | TO-92 |
| L0103DT | 400 V | 3 mA | 5 mA | SOT-223 |
| L0103MT | 600 V | 3 mA | 5 mA | SOT-223 |
| L0103NT | 800 V | 3 mA | 7 mA | SOT-223 |
| L0107DE | 400 V | 5 mA | 7 mA | TO-92 |
| L0107ME | 600 V | 5 mA | 7 mA | TO-92 |
| L0107NE | 800 V | 5 mA | 7 mA | TO-92 |
| L0107DT | 400 V | 5 mA | 7 mA | SOT-223 |
| L0107MT | 600 V | 5 mA | 7 mA | SOT-233 |
| L0107NT | 800 V | 5 mA | 7 mA | SOT-233 |
| L0109DE | 400 V | 10 mA | 10 mA | TO-92 |
| L0109ME | 600 V | 10 mA | 10 mA | TO-92 |
| L0109NE | 800 V | 10 mA | 10 mA | TO-92 |
| L0109DT | 400 V | 10 mA | 10 mA | SOT-223 |
| L0109MT | 600 V | 10 mA | 10 mA | SOT-223 |
| L0109NT | 800 V | 10 mA | 10 mA | SOT-223 |

