

Ultra-compact two-axis gyroscope for optical image stabilization

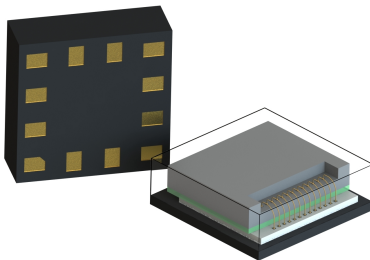

LGA-12 (2.0 x 2.0 x 0.7 mm)

Features

- ± 100 dps / ± 200 dps full-scale range
- 5 degree phase delay
- 3.8 mdps/ $\sqrt{\text{Hz}}$ rate noise density
- Wide supply voltage range: 1.7 V to 3.6 V
- Low-voltage compatible IOs
- 3- and 4-wire SPI digital interface
- Embedded temperature sensor
- Embedded self-test
- Integrated low-pass filters with user-selectable bandwidth
- Power-down and sleep modes for smart power saving
- ECOPACK[®], RoHS and “Green” compliant

Applications

- Optical image stabilization

Description

The **L20G20IS** is a two-axis MEMS gyroscope for optical image stabilization applications.

It includes a sensing element and an IC interface capable of providing the measured angular rate to the application through an SPI digital interface.

The unique sensing element is manufactured using a dedicated micromachining process developed by STMicroelectronics to produce inertial sensors and actuators on silicon wafers.

The IC interface is manufactured using a CMOS process that allows a high level of integration to design a dedicated circuit which is trimmed to better match the characteristics of the sensing element.

The L20G20IS is available in a plastic land grid array (LGA) package and can operate over a temperature range of -40 °C to +85 °C.

Product status link		
L20G20IS		
Product summary		
Order code	L20G20IS	L20G20ISTR
Temperature range	-40 °C to +85 °C	
Package	2.0 x 2.0 x 0.7 mm	
Packing	Tray	Tape and reel
Product label		
		

1 Block diagram and pin description

1.1 System block diagram

Figure 1. Block diagram

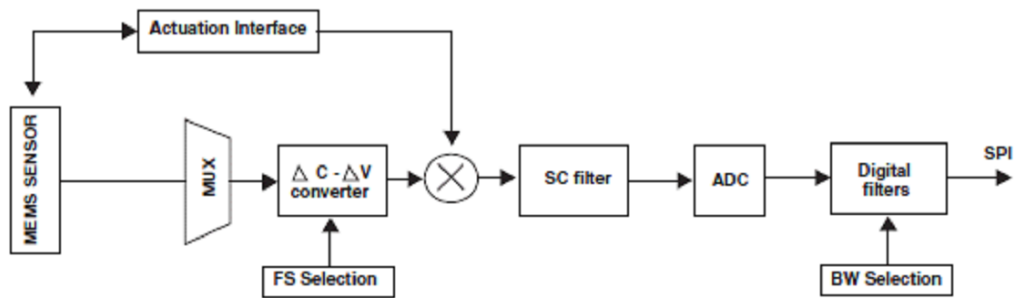

1.2 Pin description

Figure 2. Pin connections

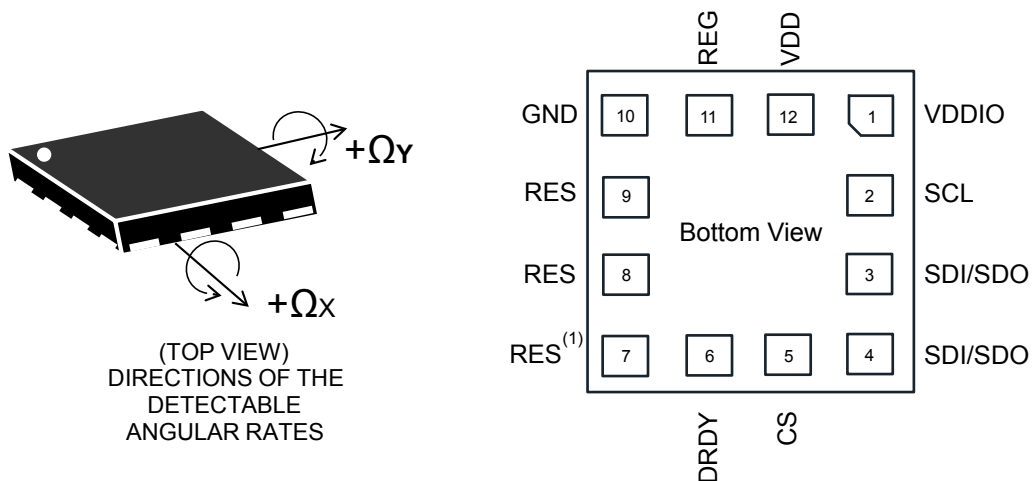

1. Leave pin electrically unconnected and soldered to PCB.

Table 1. Pin description

Pin #	Pin name	Function
1	VDDIO	Power supply for I/O pins
2	SCL	Clock line for SPI interface
3	SDI/SDO	Serial data input (SDI) 3-wire interface serial data output (SDO)
4	SDO	Serial data output (SDO)
5	CS	Chip-select line
6	DRDY	Data-ready signal
7	RES ⁽¹⁾	Leave unconnected
8	RES	Connect to GND
9	RES	Connect to GND
10	GND	0 V power supply
11	REG	Capacitance connection pin for internal regulator
12	VDD	Power supply

1. Leave pin electrically unconnected and soldered to PCB.

2 Mechanical and electrical specifications

2.1 Mechanical characteristics

The values listed in the table below are specified for $V_{dd} = 2.4\text{ V}$, $T_{amb} = 25\text{ °C}$ unless otherwise specified.

Table 2. Mechanical characteristics

Symbol	Parameter	Test condition	Min.	Typ. ⁽¹⁾	Max.	Unit
FS	Measurement range			±100		dps
				±200		
So	Sensitivity	FS = ±100 dps		262		LSB/dps
		FS = ±200 dps		131		
So	Sensitivity initial tolerance ⁽²⁾			±1.5		%
TSo	Sensitivity drift vs. temp. ⁽³⁾	Delta from 25°C; range [-20°C to 75°C]		1		%
DVoff	Digital zero-rate level ⁽⁴⁾			±5		dps
TDVoff	Digital zero-rate level drift vs. temp.	Delta from 25°C; range [-20°C to 75°C]		0.03		dps/°C
Rn	Rate noise density ⁽⁵⁾	at 20 Hz		3.8		mdps/ $\sqrt{\text{Hz}}$
PhD	Phase delay ⁽⁶⁾	at 20 Hz (450 Hz BW selected)		5		deg
ODR	Output data rate			9.33		kHz
Ton	Turn-on time			35		ms
ST	Gyroscope self-test		20		90	dps
Top	Operating temperature range		-40		+85	°C

1. Typical specifications are not guaranteed.
2. Sensitivity value after factory calibration test and trimming.
3. Measurements are performed in a uniform temperature setup and they are based on characterization data with a limited number of samples, not measured during final test production.
4. Zero-rate level value after factory calibration test and trimming.
5. Guaranteed by design.
6. Refer to [Section 4 L20G20IS filtering chain](#) for filtering details.

2.2 Electrical characteristics

The values listed in the table below are specified for $V_{dd} = 2.4\text{ V}$, $T_{amb} = 25\text{ °C}$ unless otherwise specified.

Table 3. Electrical characteristics

Symbol	Parameter	Test condition	Min.	Typ. ⁽¹⁾	Max.	Unit
VDD	Supply voltage		1.7		3.6	V
VDD_IO	I/O pins supply voltage		1.7		3.6	V
I _{dd}	Supply current in normal mode			1.4		mA
I _{ddPDN}	Supply current in power-down mode			5		uA
V _{IH}	Digital high-level input voltage		0.7 *VDD_IO			V
V _{IL}	Digital low-level input voltage				0.3 *VDD_IO	V
V _{OH}	High-level output voltage	I _{OH} = 4 mA ⁽²⁾	VDD_IO - 0.2			V
V _{OL}	Low-level output voltage	I _{OL} = 4 mA ⁽²⁾			0.2	V
Top	Operating temperature range		-40		+85	°C

1. Typical specifications are not guaranteed
2. 4 mA is the maximum driving capability, i.e. the maximum DC current that can be sourced/sunk by the digital pad in order to guarantee the correct digital output voltage levels V_{OH} and V_{OL} .

2.3 Temperature sensor characteristics

The values listed in the table below are specified for $V_{dd} = 2.4\text{ V}$, $T_{amb} = 25\text{ °C}$ unless otherwise specified.

Table 4. Temperature sensor characteristics

Symbol	Parameter	Test condition	Min.	Typ. ⁽¹⁾	Max.	Unit
TSDr	Temperature sensor output change vs. temp			0.0625		°C/digit
TODR	Temperature refresh rate			70		Hz
TACC	Temperature absolute accuracy ⁽²⁾			±4		°C
Top	Operating temperature range		-40		+85	°C

1. Typical specifications are not guaranteed
2. The output of the temperature is 0 at 25 °C.

2.4 SPI - serial peripheral interface

Subject to general operating conditions for Vdd and Top.

Table 5. SPI slave timing values

Symbol	Parameter	Value ⁽¹⁾		Unit
		Min	Max	
$t_{c(SCL)}$	SPI clock cycle	100		ns
$f_{c(SCL)}$	SPI clock frequency		10	MHz
$t_{su(CS)}$	CS setup time	5		ns
$t_{h(CS)}$	CS hold time	8		
$t_{su(SI)}$	SDI input setup time	5		
$t_{h(SI)}$	SDI input hold time	15		
$t_{v(SO)}$	SDO valid output time		50	
$t_{h(SO)}$	SDO output hold time	6		
$t_{dis(SO)}$	SDO output disable time		50	

1. Values are guaranteed at 10 MHz clock frequency for SPI, based on characterization results, not tested in production.

Figure 3. SPI slave timing diagram

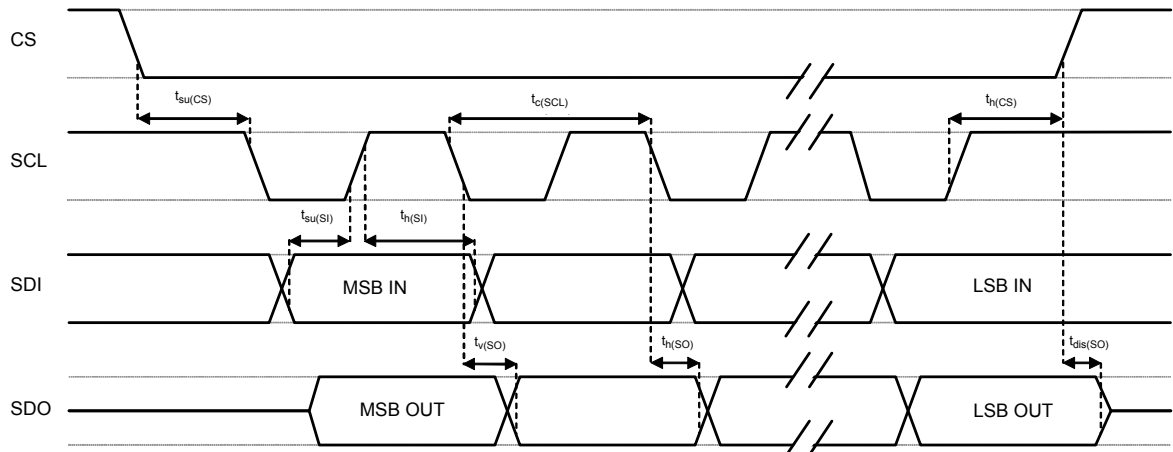

Note: Measurement points are done at $0.2 \cdot V_{dd_IO}$ and $0.8 \cdot V_{dd_IO}$, for both input and output ports.

2.5 Absolute maximum ratings

Stresses above those listed as “absolute maximum ratings” may cause permanent damage to the device. This is a stress rating only and functional operation of the device under these conditions is not implied. Exposure to maximum rating conditions for extended periods may affect device reliability.

Table 6. Absolute maximum ratings

Symbol	Ratings	Maximum value	Unit
Vdd	Power supply	-0.3 to 4.8	V
Vdd_IO	Power supply for I/O pins	-0.3 to Vdd	V
Vin	Input voltage on: (CS, SDI/SDO, SDO, SCL)	-0.3 to Vdd_IO +0.1	V
T _{STG}	Storage temperature range	-40 to +125	°C
Sg	Acceleration <i>g</i> for 0.2 ms	10,000	<i>g</i>
ESD	Electrostatic discharge protection	2 (HBM)	kV

Note: Supply voltage on any pin should never exceed 4.8 V.



This device is sensitive to mechanical shock, improper handling can cause permanent damage to the part.



This device is sensitive to electrostatic discharge (ESD), improper handling can cause permanent damage to the part.

3 Terminology and functionality

3.1 Sensitivity

An angular rate gyroscope is a device that produces a positive-going digital output for counterclockwise rotation around the sensitive axis considered. Sensitivity describes the gain of the sensor and can be determined by applying a defined angular velocity to it. This value changes very little over temperature and time.

3.2 Zero-rate level

The zero-rate level describes the actual output signal if there is no angular rate present. The zero-rate level of highly accurate MEMS sensors is, to some extent, a result of stress to the sensor and therefore the zero-rate level can slightly change after mounting the sensor on a printed circuit board or after exposing it to extensive mechanical stress. This value changes very little over temperature and time.

3.3 Data-ready interrupt and synchronous reading

On the L20G20IS the angular rate data can be retrieved using a synchronous read. To perform a synchronous read, [CTRL4_OIS \(0Eh R/W\)](#) (DRDY_EN) has to be set to '1' in order to enable the data-ready interrupt on the DRDY pin (refer to [Figure 7. L20G20IS electrical connections](#)). To properly perform a synchronous read, the angular rate data have to be read every time the DRDY pin goes high.

The DRDY signal can be latched (default condition) or pulsed if [CTRL1_OIS \(0Bh R/W\)](#)(DR_DRDY) is set to '1'. When a latched condition is selected, the interrupt goes low when the high part of one of the output channels is read (OUT_X_H (04h) or OUT_Y_H (06h)) and returns high when new data is generated. When a pulsed condition is selected, the interrupt behavior is independent from the read operations and remains high for 75 µsec every time new data is generated. The DRDY pin is set by default as push-pull output, but it can be configured as open-drain output by setting [CTRL4_OIS \(0Eh R/W\)](#) (DRDY_OD) to '1'.

3.4 Temperature sensor

The temperature data can be retrieved from the [TEMP_OUT_L \(01h R\)](#), [TEMP_OUT_H \(02h R\)](#) registers, as two's complement data in 12-bit format left-justified. The output of the temperature sensor is 0 at 25 °C.

4 L20G20IS filtering chain

The filtering chain for the L20G20IS appears in the figure below.

Figure 6. Filtering chain block diagram

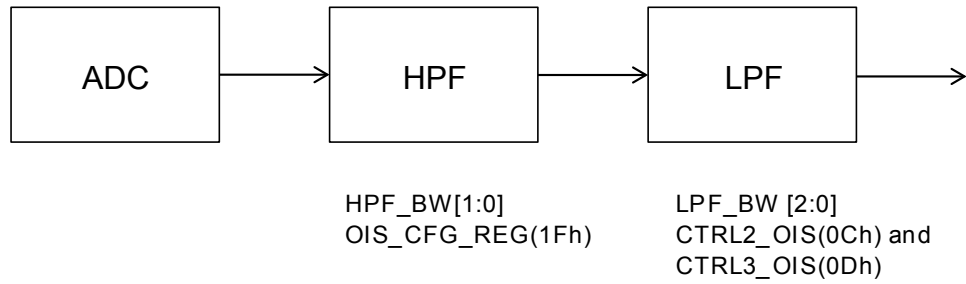

Table 7. Digital LPF configuration

LPF_BW2	LPF_BW1	LPF_BW0	LPF BW [Hz]	Phase delay [°]
0	0	0	290	7 @ 20 Hz
0	0	1	210	9 @ 20 Hz
0	1	0	160	11 @ 20 Hz
0	1	1	450	5 @ 20 Hz
1	x	x	1150	1 @ 10 Hz

Table 8. Digital HPF configuration

HPF_BW[1:0]	HPF cutoff [Hz]
00	0.023
01	0.091
10	0.324
11	1.457

5 Application hints

Figure 7. L20G20IS electrical connections

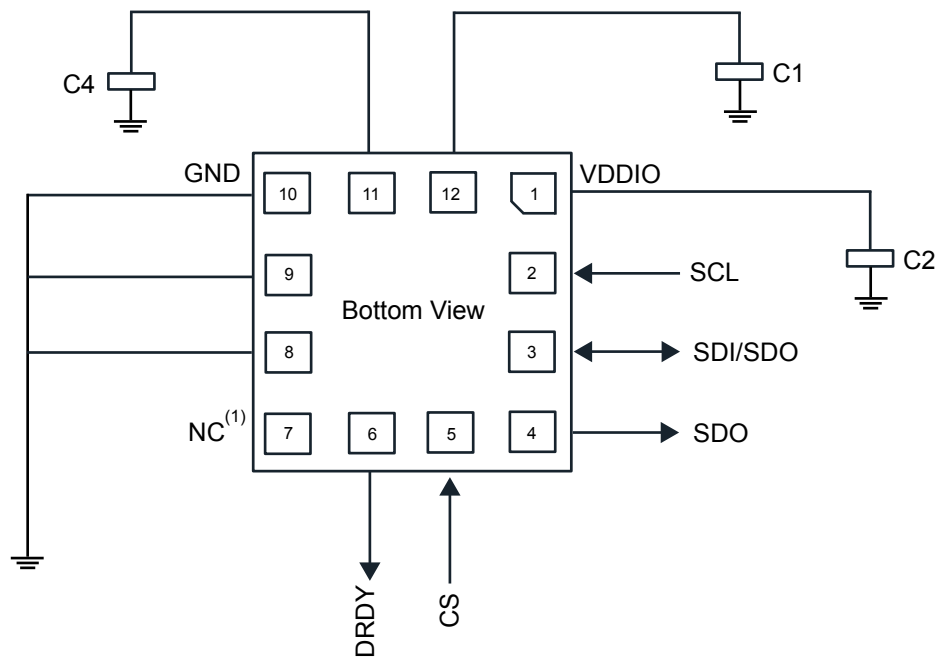

External Component	Value	Purpose
C1	100nF	Decoupling
C2	100nF	Decoupling
C4	100nF (5V class)	Internal Regulator

1. Leave pin electrically unconnected and soldered to PCB.

Power supply decoupling capacitors (C1, C2) should be placed as near as possible to the supply pins on the device (common design practice).

5.1 Internal pin status

Table 9. Internal pin status

Pin #	Pin name	Function	Status
1	VDDIO	Power supply for I/O pins	
2	SCL	Clock line for SPI interface	Default: input without pull-up
3	SDI/SDO	Serial data input (SDI) 3-wire interface serial data output (SDO)	Default: input without pull-up
4	SDO	Serial data output (SDO)	Default: input without pull-up
5	CS	Chip-select line	Default: input without pull-up
6	DRDY	Data ready signal	Default: push-pull to gnd
7	RES	Leave unconnected	Default: push-pull to gnd
8	RES	Connect to GND	Internally unconnected
9	RES	Connect to GND	Internally unconnected
10	GND	0 V power supply	
11	REG	Capacitance connection pin for internal regulator	
12	VDD	Power supply	

6 Digital interfaces

The registers embedded inside the L20G20IS may be accessed through the SPI serial interfaces.

Table 10. Serial interface pin description

Pin name	Pin description
CS	Chip-select line
SCL	SPI serial port clock
SDI/SDO	Serial data input (SDI) 3-wire interface serial data output (SDO)
SDO	Serial data output (SDO)

6.1 SPI bus interface

The SPI is a bus slave. The SPI allows writing to and reading from the registers of the device.

The serial interface connects to applications using 4 wires: **CS**, **SCL**, **SDI** and **SDO**.

CS is the serial port enable and it is controlled by the SPI master. It goes low at the start of the transmission and goes back high at the end. **SCL** is the serial port clock and it is controlled by the SPI master. It is stopped high when **CS** is high (no transmission). **SDI** and **SDO** are respectively the serial port data input and output. Those lines are driven at the falling edge of **SCL** and should be captured at the rising edge of **SCL**.

Both the read register and write register commands are completed in 16 clock pulses or in multiples of 8 in case of multiple read/write bytes. Bit duration is the time between two falling edges of **SCL**. The first bit (bit 0) starts at the first falling edge of **SCL** after the falling edge of **CS** while the last bit (bit 15, bit 23, ...) starts at the last falling edge of **SCL** just before the rising edge of **CS**.

bit 0: \overline{RW} bit. When 0, the data DI(7:0) is written into the device. When 1, the data DO(7:0) from the device is read. In latter case, the chip will drive SDO at the start of bit 8.

bit 1-7: address AD(6:0). This is the address field of the indexed register.

bit 8-15: data DI(7:0) (write mode). This is the data that is written into the device (MSb first).

bit 8-15: data DO(7:0) (read mode). This is the data that is read from the device (MSb first).

The function and the behavior of SDI and SDO remain unchanged.

6.1.1 SPI read

3-wire mode is entered by setting the (SIM) bit equal to '1' (SPI serial interface mode selection).

Figure 8. SPI read protocol

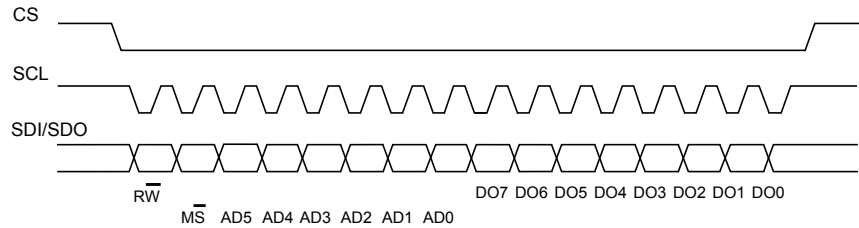

The SPI read command is performed with 16 clock pulses:

bit 0: READ bit. The value is 1.

bit 1: \overline{MS} bit. When 0, does not increment the address; when 1, increments the address in multiple reads.

bit 2-7: address AD(5:0). This is the address field of the indexed register.

bit 8-15: data DO(7:0) (read mode). This is the data that will be read from the device (MSb first).

A multiple read command is also available.

6.1.2 SPI write

Figure 9. SPI write protocol

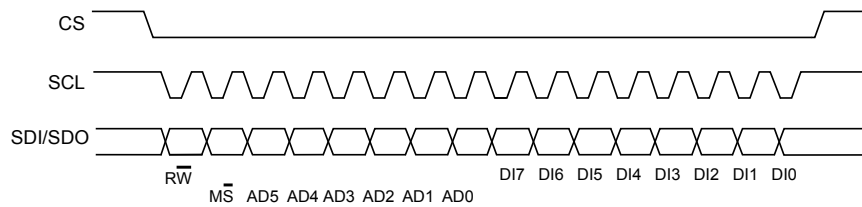

The SPI write command is performed with 16 clock pulses. A multiple byte write command is performed by adding blocks of 8 clock pulses to the previous one.

bit 0: WRITE bit. The value is 0.

bit 1: \overline{MS} bit. When 0, does not increment the address; when 1, increments the address in multiple writes.

bit 2 -7: address AD(5:0). This is the address field of the indexed register.

bit 8-15: data DI(7:0) (write mode). This is the data that will be written inside the device (MSb first).

bit 16-... : data DI(...-8). Further data in multiple byte writes.

Figure 10. Multiple byte SPI write protocol (2-byte example)

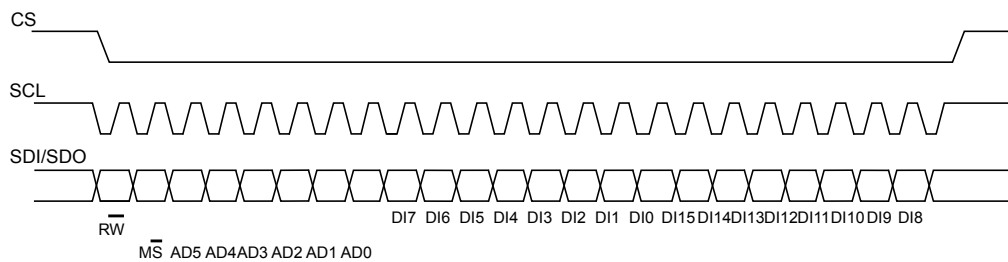

7 Register mapping

The device contains a set of registers which are used to control its behavior and to retrieve angular rate data. The register address, consisting of 8 bits, is used to identify them and to write the data through the serial interface.

Table 11. Register address map

Name	Type	Register address [Hex]	Default [Hex]
WHO_AM_I	r	00	DA
TEMP_OUT_L	r	01	output
TEMP_OUT_H	r	02	output
OUT_X_L	r	03	output
OUT_X_H	r	04	output
OUT_Y_L	r	05	output
OUT_Y_H	r	06	output
DATA_STATUS_OIS	r	0A	output
CTRL1_OIS	r/w	0B	00
CTRL2_OIS	r/w	0C	00
CTRL3_OIS	r/w	0D	00
CTRL4_OIS	r/w	0E	00
OFF_X	r/w	0F	00
OFF_Y	r/w	10	00
Reserved	--	11 to 1E	--
OIS_CFG_REG	r/w	1F	00

Registers marked as Reserved must not be changed. Writing to those registers may cause permanent damage to the device.

To guarantee the proper behavior of the device, all register addresses not listed in the above table must not be accessed and the content stored in those registers must not be changed.

8 Register description

The device contains a set of registers which are used to control its behavior and to retrieve angular rate data. The register address, consisting of 8 bits, is used to identify them and to write the data through the serial interface.

8.1 WHO_AM_I (00h R)

Table 12. WHO_AM_I register

1	1	0	1	1	0	1	0
---	---	---	---	---	---	---	---

8.2 TEMP_OUT_L (01h R), TEMP_OUT_H (02h R)

Table 13. TEMP_OUT_L register

Temp3	Temp2	Temp1	Temp0	0	0	0	0
-------	-------	-------	-------	---	---	---	---

Table 14. TEMP_OUT_H register

Temp11	Temp10	Temp9	Temp8	Temp7	Temp6	Temp5	Temp4
--------	--------	-------	-------	-------	-------	-------	-------

Table 15. TEMP_OUT register description

Temp11-Temp0	Temperature data. Refer to Section 3.4 Temperature sensor on how to read the temperature sensor output data.
--------------	---

8.3 OUT_X_L (03h R), OUT_X_H (04h R)

X-axis angular rate data. The value is expressed as two's complement.

8.4 OUT_Y_L (05h R), OUT_Y_H (06h R)

Y-axis angular rate data. The value is expressed as two's complement.

8.5 DATA_STATUS_OIS (0Ah R)

Table 16. DATA_STATUS_OIS register

XYOR_OIS	XOR_OIS	YOR_OIS	0	XYDA_OIS	XDA_OIS	YDA_OIS	0
----------	---------	---------	---	----------	---------	---------	---

Table 17. DATA_STATUS_OIS description

XYOR_OIS	OIS chain global data overrun. Default value: 0 (0: no overrun has occurred; 1: a new set of data has overwritten the previous set before the read)
XOR_OIS	OIS chain X-axis data overrun. Default value: 0 (0: no overrun has occurred; 1: new X-axis data has overwritten a previous value before the read)
YOR_OIS	OIS Y-axis data overrun. Default value: 0 (0: no overrun has occurred; 1: new Y-axis data has overwritten a previous value before the read)
XYDA_OIS	OIS chain global new data available. Default value: 0 (0: a new set of data (X,Y axes) is not yet available; 1: a new set of data (X,Y axes) is available)
XDA_OIS	OIS chain X-axis new data available. Default value: 0 (0: new data for the X-axis is not yet available; 1: new data for the X-axis is available)
YDA_OIS	OIS chain Y-axis new data available. Default value: 0 (0: new data for the Y-axis is not yet available; 1: new data for the Y-axis is available)

8.6 CTRL1_OIS (0Bh R/W)

Table 18. CTRL1_OIS register

BOOT	DR_PULSED	BLE	SIM	ODU	ORIENT	PW1	PW0
------	-----------	-----	-----	-----	--------	-----	-----

Table 19. CTRL1_OIS register description

BOOT	Reboot memory content. Default value: 0 (0: normal mode; 1: reboot memory content) ⁽¹⁾
DR_PULSED	DRDY signal pulsed. Default value: 0 (0: DRDY is latched; 1: DRDY is pulsed)
BLE	Big/Little Endian Data Selection. Default value: 0 (0: Data LSbyte @ lower address; 1: Data MSbyte @ lower address)
SIM	SPI Serial Interface Mode configuration. Default value: 0 (0: 4-wire interface; 1: 3-wire interface)
ODU	Output Data Update. Default value: 0 (0: output registers not updated until MSB and LSB have been read; 1: OIS output registers are updated continuously)

ORIENT	Directional orientation selection. Default value: 0 (0: X-axis - Y-axis; 1: Y-axis - X-axis)
PW[1:0]	Power mode selection. Default: 00 Refer to Table 20. Operating mode selection .

1. Boot request is executed as soon as internal oscillator is turned on. It is possible to set this bit while in power-down mode in which case it will be served at the next normal mode or sleep mode.

Table 20. Operating mode selection

PW1	PW0	Operating mode selection
0	0	Power-down
0	1	Power-down
1	0	Sleep mode
1	1	Normal mode

8.7 CTRL2_OIS (0Ch R/W)

Table 21. CTRL2_OIS register

SignX	SignY	LPF_BW1	LPF_BW0	0 ⁽¹⁾	HP_RST	SW_RST	HPF
-------	-------	---------	---------	------------------	--------	--------	-----

1. This bit must be set to '0' for proper operation of the device.

Table 22. CTRL2_OIS register description

SignX	X-axis angular rate sign selection. Default: 0 (0: sign not inverted; 1: sign inverted)
SignY	Y-axis angular rate sign selection. Default: 0 (0: sign not inverted; 1: sign inverted)
LPF_BW[1:0]	Low-pass filter bandwidth selection. Refer to Figure 6. Filtering chain block diagram and Table 23. Digital LPF configuration .
HP_RST	Reset high-pass filter. (0: disabled; 1: enabled)
SW_RST	Software reset. (0: disabled; 1: enabled)
HPF	Digital high-pass filter enable. Default: 0 (0: high-pass filter is disabled; 1: high-pass filter is enabled)

Table 23. Digital LPF configuration

LPF_BW2	LPF_BW1	LPF_BW0	LPF BW [Hz]	Phase delay [°]
0	0	0	290	7 @ 20 Hz
0	0	1	210	9 @ 20 Hz
0	1	0	160	11 @ 20 Hz
0	1	1	450	5 @ 20 Hz
1	x	x	1150	1 @ 10 Hz

8.8 CTRL3_OIS (0Dh R/W)

Table 24. CTRL3_OIS register

0 ⁽¹⁾	0 ⁽¹⁾	0 ⁽¹⁾	ST_SIGN	ST_EN	0 ⁽¹⁾	H_L_ACTIVE	LPF_BW2
------------------	------------------	------------------	---------	-------	------------------	------------	---------

1. These bits must be set to '0' for proper operation of the device

Table 25. CTRL3_OIS register description

ST_SIGN	Self-test sign. Default value: 0 (0: not inverted sign; 1: inverted sign)
ST_EN	Self-test enable. Default value: 0 (0: ST disabled; 1: ST enabled)
H_L_ACTIVE	Data-ready signal active level. Default value: 0 (0: active high; 1: active low)
LPF_BW2	Low-pass filter bandwidth selection. Refer to Figure 6. Filtering chain block diagram and Table 23. Digital LPF configuration .

8.9 CTRL4_OIS (0Eh R/W)

Table 26. CTRL4_OIS register

0 ⁽¹⁾	0 ⁽¹⁾	0 ⁽¹⁾	DRDY_EN	0 ⁽¹⁾	TEMP_DATA_ON_DRDY	DRDY_OD	0 ⁽¹⁾
------------------	------------------	------------------	---------	------------------	-------------------	---------	------------------

1. These bits must be set to '0' for proper operation of the device.

Table 27. CTRL4_OIS register description

DRDY_EN	Data ready enable on DRDY pin. Default: 0 (1: DRDY on pin). Refer to Section 3.3 Data-ready interrupt and synchronous reading
TEMP_DATA_ON_DRDY	Temperature data-ready signal on DRDY pad. (0: disabled; 1: enabled)
DRDY_OD	DRDY pin configuration. Default value: 0 (0: push-pull; 1: open drain)

8.10 OFF_X (0Fh R/W)

Table 28. OFF_X register

0 ⁽¹⁾	OFFX6	OFFX5	OFFX4	OFFX3	OFFX2	OFFX1	OFFX0
------------------	-------	-------	-------	-------	-------	-------	-------

1. This bit must be set to '0' for proper operation of the device

Table 29. OFF_X register description

OFFX [6:0]	User offset correction for X-axis. Default value: 000 0000 The value is expressed as two's complement.
------------	---

The calibration step is -0.98 dps/LSB.

8.11 OFF_Y (10h R/W)

Table 30. OFF_Y register

0 ⁽¹⁾	OFFY6	OFFY5	OFFY4	OFFY3	OFFY2	OFFY1	OFFY0
------------------	-------	-------	-------	-------	-------	-------	-------

1. This bit must be set to '0' for proper operation of the device

Table 31. OFF_Y register description

OFFY [6:0]	User offset correction for Y-axis. Default 000 0000 The value is expressed at two's complement
------------	---

Calibration step is 0.98 dps/LSB.

8.12 OIS_CFG_REG (1Fh R/W)

Table 32. OIS_CFG_REG register

0 ⁽¹⁾	0 ⁽¹⁾	0 ⁽¹⁾	0 ⁽¹⁾	FS_SEL	0 ⁽¹⁾	HPF_BW[1]	HPF_BW[0]
------------------	------------------	------------------	------------------	--------	------------------	-----------	-----------

1. These bits must be set to '0' for proper operation of the device

Table 33. OIS_CFG_REG register description

FS_SEL	Full-scale selection. Default value: 0 (0: ±100 dps; 1: ±200 dps)
HPF_BW[1:0]	Digital HPF cutoff selection. Refer to Table 34. Digital HPF configuration

Table 34. Digital HPF configuration

HPF_BW[1:0]	HPF cutoff [Hz]
00	0.023
01	0.091
10	0.324
11	1.457

9 Package information

In order to meet environmental requirements, ST offers these devices in different grades of ECOPACK® packages, depending on their level of environmental compliance. ECOPACK® specifications, grade definitions and product status are available at: www.st.com. ECOPACK® is an ST trademark.

9.1 Soldering information

The LGA package is compliant with the ECOPACK®, RoHS and “Green” standard. It is qualified for soldering heat resistance according to JEDEC J-STD-020. Land pattern and soldering recommendations are available at www.st.com/mems.

9.2 LGA-12 package

Figure 11. LGA-12: package outline and mechanical data

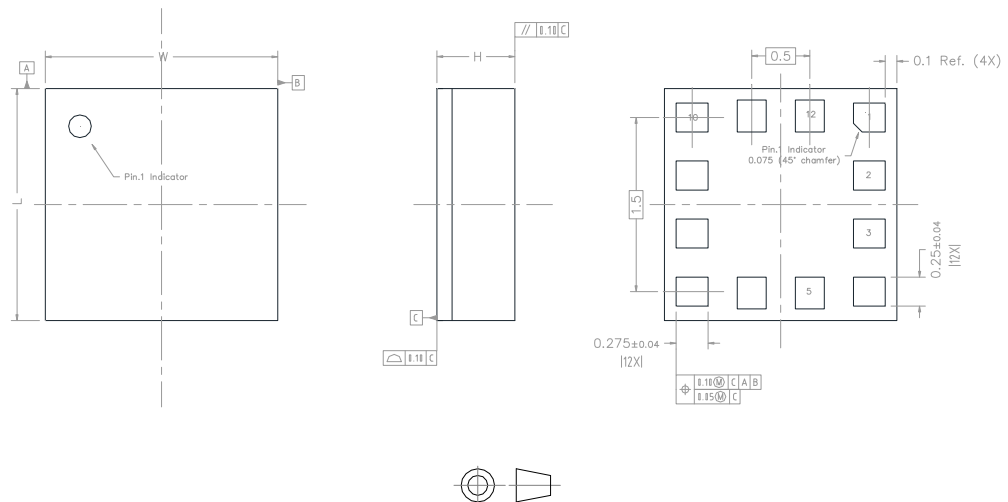

Dimensions are in millimeter unless otherwise specified
General Tolerance is +/-0.15mm unless otherwise specified

OUTER DIMENSIONS

ITEM	DIMENSION [mm]	TOLERANCE [mm]
Length [L]	2	±0.1
Width [W]	2	±0.1
Height [H]	0.7 MAX	/

DM00170568_5

9.3 LGA-12 packing information

Figure 12. Carrier tape information for LGA-12 package

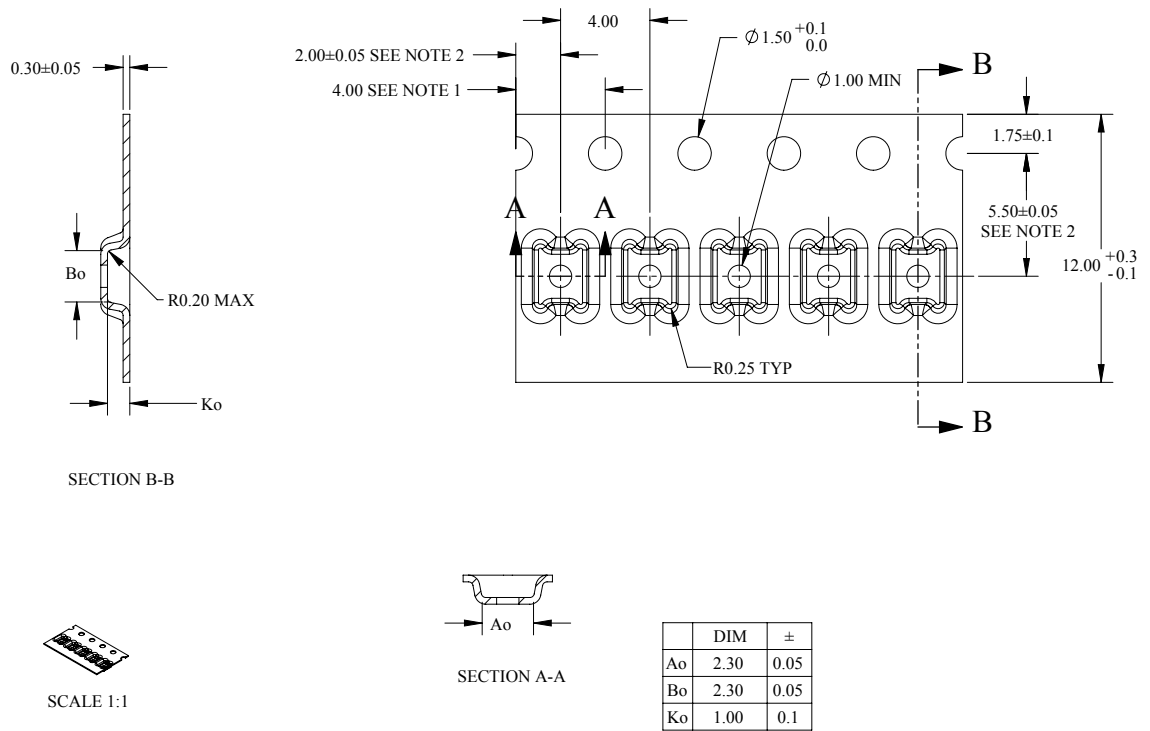

NOTES:

1. 10 SPROCKET HOLE PITCH CUMULATIVE TOLERANCE ± 0.2
2. POCKET POSITION RELATIVE TO SPROCKET HOLE MEASURED AS TRUE POSITION OF POCKET, NOT POCKET HOLE.
3. Ao AND Bo ARE CALCULATED ON A PLANE AT A DISTANCE "R" ABOVE THE BOTTOM OF THE POCKET.

Figure 13. LGA-12 package orientation in carrier tape

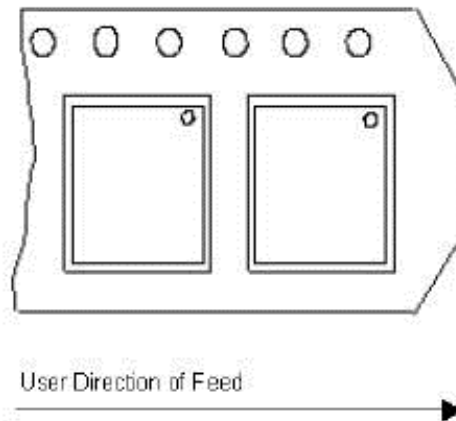

Figure 14. Reel information for carrier tape of LGA-12 package

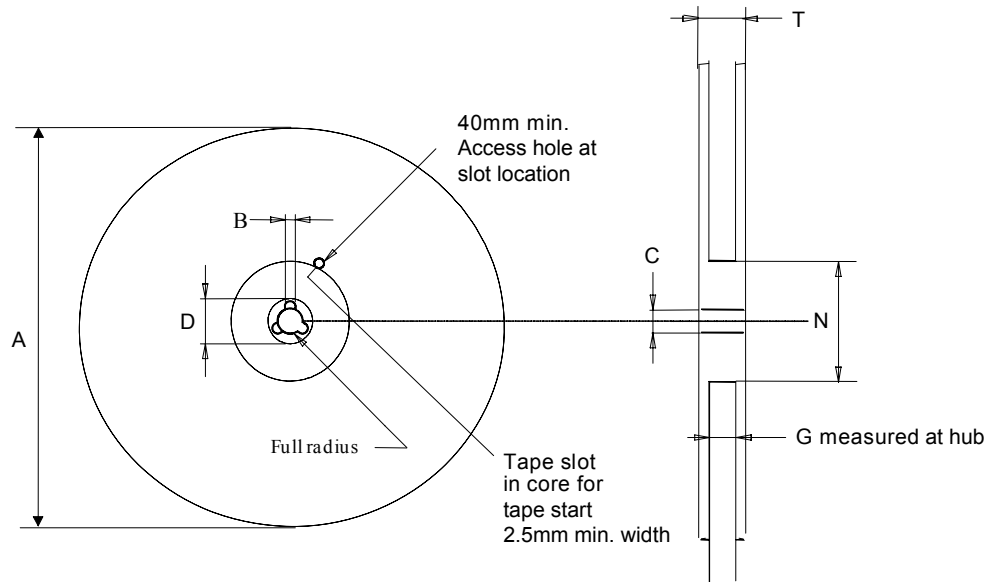

Table 35. Reel dimensions for carrier tape of LGA-12 package

Reel dimensions (mm)	
A (max)	330
B (min)	1.5
C	13 ±0.25
D (min)	20.2
N (min)	60
G	12.4 +2/-0
T (max)	18.4

Revision history

Table 36. Document revision history

Date	Revision	Changes
27-Jun-2016	1	Initial release
03-Jul-2017	2	Document status promoted to production data Updated Section 9: Package information
01-Oct-2018	3	Added product label indicating participation in ST's sustainable technology program

Contents

1	Block diagram and pin description	2
1.1	System block diagram	2
1.2	Pin description	3
2	Mechanical and electrical specifications	4
2.1	Mechanical characteristics	4
2.2	Electrical characteristics	5
2.3	Temperature sensor characteristics	5
2.4	SPI - serial peripheral interface	6
2.5	Absolute maximum ratings	7
3	Terminology and functionality	8
3.1	Sensitivity	8
3.2	Zero-rate level	8
3.3	Data-ready interrupt and synchronous reading	8
3.4	Temperature sensor	8
4	L20G20IS filtering chain	9
5	Application hints	10
5.1	Internal pin status	11
6	Digital interfaces	12
6.1	SPI bus interface	12
6.1.1	SPI read	13
6.1.2	SPI write	14
7	Register mapping	15
8	Register description	16
8.1	WHO_AM_I (00h R)	16
8.2	TEMP_OUT_L (01h R), TEMP_OUT_H (02h R)	16
8.3	OUT_X_L (03h R), OUT_X_H (04h R)	16
8.4	OUT_Y_L (05h R), OUT_Y_H (06h R)	16
8.5	DATA_STATUS_OIS (0Ah R)	17
8.6	CTRL1_OIS (0Bh R/W)	17

8.7	CTRL2_OIS (0Ch R/W)	18
8.8	CTRL3_OIS (0Dh R/W)	18
8.9	CTRL4_OIS (0Eh R/W)	19
8.10	OFF_X (0Fh R/W)	20
8.11	OFF_Y (10h R/W)	20
8.12	OIS_CFG_REG (1Fh R/W)	21
9	Package information	22
9.1	Soldering information	22
9.2	LGA-12 package	22
9.3	LGA-12 packing information	22
	Revision history	25

List of tables

Table 1.	Pin description	3
Table 2.	Mechanical characteristics	4
Table 3.	Electrical characteristics	5
Table 4.	Temperature sensor characteristics	5
Table 5.	SPI slave timing values	6
Table 6.	Absolute maximum ratings	7
Table 7.	Digital LPF configuration	9
Table 8.	Digital HPF configuration	9
Table 9.	Internal pin status	11
Table 10.	Serial interface pin description	12
Table 11.	Register address map	15
Table 12.	WHO_AM_I register	16
Table 13.	TEMP_OUT_L register	16
Table 14.	TEMP_OUT_H register	16
Table 15.	TEMP_OUT register description	16
Table 16.	DATA_STATUS_OIS register	17
Table 17.	DATA_STATUS_OIS description	17
Table 18.	CTRL1_OIS register	17
Table 19.	CTRL1_OIS register description	17
Table 20.	Operating mode selection	18
Table 21.	CTRL2_OIS register	18
Table 22.	CTRL2_OIS register description	18
Table 23.	Digital LPF configuration	18
Table 24.	CTRL3_OIS register	19
Table 25.	CTRL3_OIS register description	19
Table 26.	CTRL4_OIS register	19
Table 27.	CTRL4_OIS register description	19
Table 28.	OFF_X register	20
Table 29.	OFF_X register description	20
Table 30.	OFF_Y register	20
Table 31.	OFF_Y register description	20
Table 32.	OIS_CFG_REG register	21
Table 33.	OIS_CFG_REG register description	21
Table 34.	Digital HPF configuration	21
Table 35.	Reel dimensions for carrier tape of LGA-12 package	24
Table 36.	Document revision history	25

List of figures

Figure 1.	Block diagram	2
Figure 2.	Pin connections	3
Figure 3.	SPI slave timing diagram	6
Figure 6.	Filtering chain block diagram	9
Figure 7.	L20G20IS electrical connections	10
Figure 8.	SPI read protocol	13
Figure 9.	SPI write protocol	14
Figure 10.	Multiple byte SPI write protocol (2-byte example)	14
Figure 11.	LGA-12: package outline and mechanical data	22
Figure 12.	Carrier tape information for LGA-12 package	23
Figure 13.	LGA-12 package orientation in carrier tape.	23
Figure 14.	Reel information for carrier tape of LGA-12 package	24