

## Automotive 5 V low drop voltage regulator

Datasheet - production data



- Precision output voltage 5 V +/-2%
- Reset circuit sensing the output voltage
- Programmable reset pulse delay with external capacitor
- Thermal shutdown and short circuit protection
- Wide temperature range (Tj = -40°C to 150°C)
- Enable input for enabling / disabling the voltage regulator

### Features

Max DC supply voltage	$V_s$	40 V
Max output voltage tolerance	$\Delta V_0$	+/-2 %
Max dropout voltage	$V_{dp}$	500 mV
Output current	$I_o$	300 mA
Quiescent current	$I_{qn}$	5 $\mu A^{(1)}$ 55 $\mu A^{(2)}$

1. Typical value with regulator disabled
2. Typical value with regulator enabled

- AEC-Q100 qualified
- Operating DC supply voltage range 5.6 V to 40 V
- Low dropout voltage
- 300 mA current capability
- Low quiescent current
- Very low consumption mode



### Description

L5300AH7 is a low dropout linear regulator with microprocessor control functions such as power on reset, low voltage reset, ON/OFF control. In addition, only low value ceramic capacitor is required for stability (above or equal 220 nF).

Typical quiescent current is 60  $\mu A$  at output current equal to 0 and enable high. It drops to 10  $\mu A$  in “not enabled” mode.

On chip trimming results in high output voltage accuracy (+/-2%). Accuracy is kept over wide temperature range, line and load variation.

The maximum input voltage is 40 V. The max output current is internally limited. Internal temperature protection disables the voltage regulator output.

Table 1. Device summary

Package	Order codes	
	Tube	Tape and reel
HPAK	L5300AH7	L5300AH7TR

# Contents

- 1      Block diagram and pins description ..... 5**
  
- 2      Electrical specifications ..... 7**
  - 2.1 Absolute maximum ratings ..... 7
  - 2.2 Thermal data ..... 7
  - 2.3 Electrical characteristics ..... 8
  - 2.4 Electrical characteristics curves ..... 10
  
- 3      Application information ..... 14**
  - 3.1 Voltage regulator ..... 14
  - 3.2 Reset ..... 16
  - 3.3 Enable ..... 16
  
- 4      Package and PC board thermal data ..... 17**
  - 4.1 HPAK thermal data ..... 17
  
- 5      Package and packing information ..... 20**
  - 5.1 ECOPACK® ..... 20
  - 5.2 HPAK mechanical data ..... 20
  
- 6      Revision history ..... 22**

## List of tables

Table 1.	Device summary . . . . .	1
Table 2.	Pins description . . . . .	6
Table 3.	Absolute maximum ratings . . . . .	7
Table 4.	Thermal data . . . . .	7
Table 5.	General . . . . .	8
Table 6.	Reset . . . . .	9
Table 7.	Enable. . . . .	9
Table 8.	Thermal parameter . . . . .	19
Table 9.	HPAK mechanical data . . . . .	21
Table 10.	Document revision history . . . . .	22

## List of figures

Figure 1.	Block diagram	5
Figure 2.	Configuration diagram (top view)	5
Figure 3.	Output voltage vs $T_j$	10
Figure 4.	Output voltage vs $V_S$	10
Figure 5.	Output voltage vs $V_{En}$	10
Figure 6.	Drop voltage vs output current	10
Figure 7.	Current consumption vs output current	11
Figure 8.	Current consumption vs output current (at light load condition)	11
Figure 9.	Current consumption vs input voltage ( $I_O = 0.1$ mA)	11
Figure 10.	Current consumption vs input voltage ( $I_O = 100$ mA)	11
Figure 11.	Current limitation vs $T_j$	11
Figure 12.	Current limitation vs input voltage	11
Figure 13.	Short-circuit current vs $T_j$	12
Figure 14.	Short-circuit current vs input voltage	12
Figure 15.	$V_{En\_high}$ vs $T_j$	12
Figure 16.	$V_{En\_low}$ vs $T_j$	12
Figure 17.	$V_{Rth}$ vs $T_j$	12
Figure 18.	$V_{Rlth}$ vs $T_j$	12
Figure 19.	$I_{cr}$ vs $T_j$	13
Figure 20.	$I_{dr}$ vs $T_j$	13
Figure 21.	Application schematic	14
Figure 22.	Stability region	15
Figure 23.	Maximum load variation response	15
Figure 24.	Reset time diagram	16
Figure 25.	PC board	17
Figure 26.	$R_{thj-amb}$ vs PCB copper area in open box free air condition	17
Figure 27.	HPAK thermal impedance junction ambient single pulse	18
Figure 28.	Thermal fitting model of a single-channel HSD in HPAK	18
Figure 29.	HPAK dimension	20

# 1 Block diagram and pins description

Figure 1. Block diagram

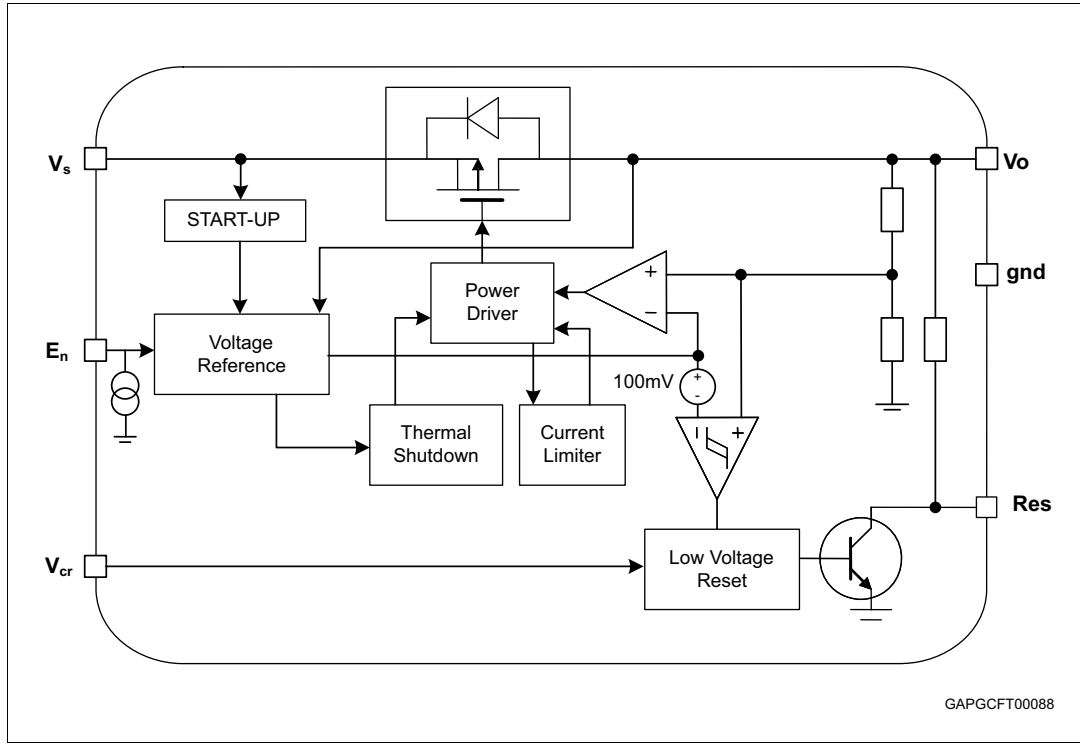

Figure 2. Configuration diagram (top view)

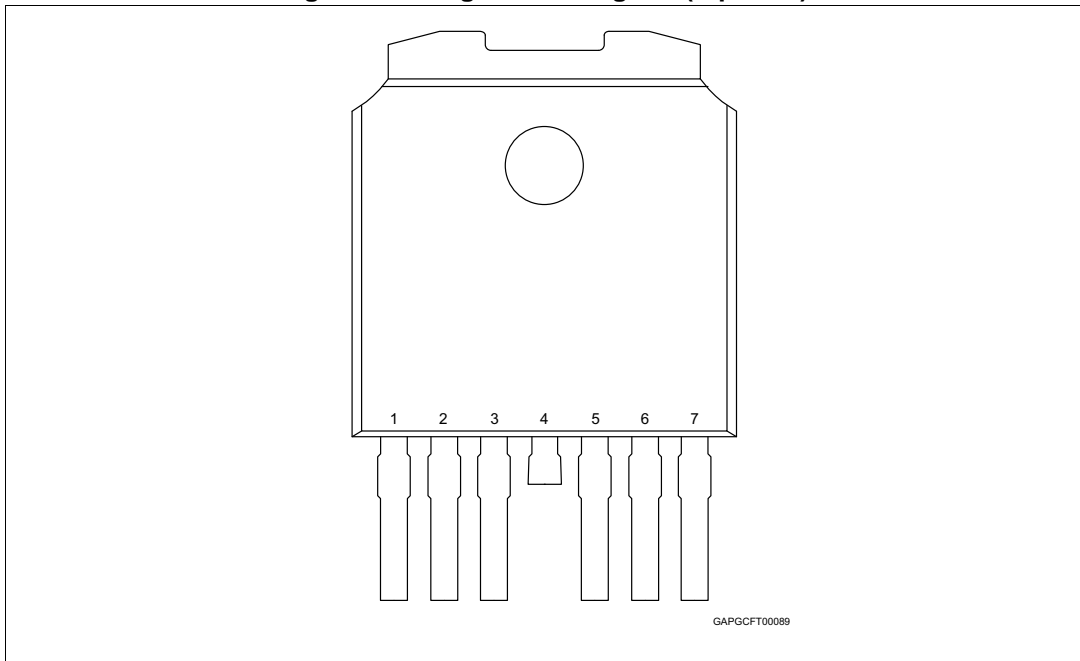

Table 2. Pins description

N°	Name	Function
1	$V_S$	Supply voltage, block directly to GND on the $I_C$ with a capacitor.
2	$E_n$	Enable input. A high signal switches the regulator ON. Connect to $V_S$ if not needed.
3	$R_{es}$	Reset output. Internally connected to $V_o$ through a 20 K $\Omega$ pull up resistor. This pin is pulled low when $V_o < V_{o\_th}$ . Keep open if not needed.
4	GND	Ground reference.
5	$V_{cr}$	Reset delay. Connect an external capacitor between $V_{cr}$ pin and ground to adjust the reset delay time. Keep open if not needed.
6	$V_{os}$	Output voltage sensing: this pin must be connected to $V_o$ .
7	$V_o$	5 V regulated output. Block to GND with a ceramic capacitor ( $\geq 220$ nF for regulator stability).

## 2 Electrical specifications

### 2.1 Absolute maximum ratings

Stressing the device above the rating listed in [Table 3: Absolute maximum ratings](#) may cause permanent damage to the device. These are stress ratings only and operation of the device at these or any other conditions above those indicated in the Operating sections of this specification is not implied. Exposure to Absolute Maximum Rating conditions for extended periods may affect device reliability.

**Table 3. Absolute maximum ratings**

Symbol	Parameter	Value	Unit
$V_{sdc}$	DC supply voltage	-0.3 to 40	V
$I_{sdc}$	Input current	Internally limited	
$V_{odc}$	DC output voltage	-0.3 to 6	V
$I_{odc}$	DC output current	Internally limited	
$V_{od Res}$	Open drain output voltage $R_{es}$	-0.3 to $V_{Vodc} + 0.3$	V
$I_{od Res}$	Open drain output current $R_{es}$	Internally limited	
$V_{cr}$	$V_{cr}$ voltage	-0.3 to $V_{Vo} + 0.3$	V
$V_{En}$	Enable input	-0.3 to 40	V
$T_j$	Junction temperature	-40 to 150	°C
$V_{ESD HBM}$	ESD HBM voltage level (HBM-MIL STD 883C)	+/- 2	kV
$V_{ESD CDM}$	ESD CDM voltage level (CDM AEC-Q100-011)	+/- 750	V

### 2.2 Thermal data

**Table 4. Thermal data**

Symbol	Parameter	Value	Unit
$R_{thj-case}$	Thermal resistance junction to case	4.8	°C/W
$R_{thj-amb}$	Thermal resistance junction to ambient	45 <sup>(1)</sup>	K/W

1. The values quoted are for PCB 77 mm x 86 mm x 1.6 mm, FR4, double layer with thermal vias (one copper heatsink layer, thickness 0.070 mm, area 8 cm<sup>2</sup>).

## 2.3 Electrical characteristics

Values specified in this section are for  $V_S = 5.6\text{ V to }31\text{ V}$ ,  $T_J = -40\text{ °C to }150\text{ °C}$ , unless otherwise stated.

Table 5. General

Pin	Symbol	Parameter	Test condition	Min	Typ	Max	Unit
$V_o$	$V_{o\_ref}$	Output voltage	$V_S = 8\text{ to }18\text{ V}$ $I_O = 8\text{ to }300\text{ mA}$	4.9	5.0	5.1	V
$V_o$	$V_{o\_ref}$	Output voltage	$V_S = 5.6\text{ to }31\text{ V}$ $I_O = 8\text{ to }300\text{ mA}$	4.85	5.0	5.15	V
$V_o$	$V_{o\_ref}$	Output voltage	$V_S = 5.6\text{ to }31\text{ V}$ $I_O = 0.1\text{ mA to }8\text{ mA}$	4.75	5.0	5.25	V
$V_o$	$I_{short}$	Short circuit current	$V_S = 13.5\text{ V}$	0.8	1.8	2.6	A
$V_o$	$I_{lim}$	Output current limitation <sup>(1)</sup>	$V_S = 13.5\text{ V}$	0.6	1.6	2.5	A
$V_S, V_o$	$V_{line}$	Line regulation voltage	$V_S = 6\text{ V to }28\text{ V}$ $I_O = 50\text{ mA}$			40	mV
$V_o$	$V_{load}$	Load regulation voltage	$V_S = 13.5\text{ V}$ $I_O = 8\text{ mA to }300\text{ mA}$ $T_J = 25\text{ °C}$			40	mV
			$V_S = 8\text{ V to }18\text{ V}$ $I_O = 8\text{ mA to }300\text{ mA}$			55	mV
$V_S, V_o$	$V_{dp}$	Drop voltage <sup>(2)</sup>	$I_O = 300\text{ mA}$			500	mV
$V_S, V_o$	SVR	Ripple rejection	$f_r = 100\text{ Hz}^{(3)}$		60		dB
$V_o$	$I_{oth\_H}$	Normal consumption mode output current		8			mA
$V_o$	$I_{oth\_L}$	Very low consumption mode output current				1.1	mA
$V_o$	$I_{oth\_Hyst}$	Output current switching threshold hysteresis	$V_S = 13.5\text{ V}$ , $T_J = 25\text{ °C}$		0.8		mA
$V_S, V_o$	$I_{qs}$	Current consumption with regulator disabled $I_{qs} = I_{VS} - I_O$	$V_S = 13.5\text{ V}$ , $E_n = \text{low}$		5	10	$\mu\text{A}$
$V_S, V_o$	$I_{qn\_1}$	Current consumption with regulator enabled $I_{qn\_1} = I_{VS} - I_O$	$V_S = 13.5\text{ V}$ , $I_O < 1\text{ mA}$ , $E_n = \text{high}$		55	80	$\mu\text{A}$
$V_S, V_o$	$I_{qn\_300}$	Current consumption with regulator enabled $I_{qn\_300} = I_{VS} - I_O$	$V_S = 13.5\text{ V}$ , $I_O = 300\text{ mA}$ , $E_n = \text{high}$		3	4.2	mA
—	$T_w$	Thermal protection temperature		150		190	$^{\circ}\text{C}$
—	$T_{w\_hy}$	Thermal protection temperature hysteresis			10		$^{\circ}\text{C}$

1. Measured output current when the output voltage has dropped 100 mV from its nominal value obtained at 13.5 V and  $I_O = 75\text{ mA}$ .



2.  $V_S - V_o$  measured dropout when the output voltage has dropped 100 mV from its nominal value obtained at 13.5 V and  $I_o = 75$  mA.
3. Guaranteed by design

Table 6. Reset

Pin	Symbol	Parameter	Test condition	Min	Typ	Max	Unit
R <sub>es</sub>	V <sub>Res_l</sub>	Reset output low voltage	R <sub>ext</sub> = 5 kΩ V <sub>o</sub> > 1 V			0.4	V
R <sub>es</sub>	I <sub>Res_lkg</sub>	Reset output high leakage current	V <sub>Res</sub> = V <sub>o</sub>			1	μA
R <sub>es</sub>	R <sub>Res</sub>	Pull up internal resistance	Versus V <sub>o</sub>	10	20	40	kΩ
R <sub>es</sub>	V <sub>o_th</sub>	V <sub>o</sub> out of regulation threshold	V <sub>o</sub> decreasing	6%	8%	10%	Below V <sub>o_ref</sub>
V <sub>cr</sub>	V <sub>Rlth</sub>	Reset timing low threshold	V <sub>S</sub> = 13.5 V	16%	19%	22%	V <sub>o_ref</sub>
V <sub>cr</sub>	V <sub>Rhth</sub>	Reset timing high threshold	V <sub>S</sub> = 13.5 V	47%	50%	53%	V <sub>o_ref</sub>
V <sub>cr</sub>	I <sub>cr</sub>	Charge current	V <sub>S</sub> = 13.5 V	10	20	30	μA
V <sub>cr</sub>	I <sub>dr</sub>	Discharge current	V <sub>S</sub> = 13.5 V	10	20	30	μA
R <sub>es</sub>	T <sub>rr</sub>	Reset reaction time	V <sub>o</sub> = V <sub>o_th</sub> - 100 mV			2	μs
R <sub>es</sub>	T <sub>rd</sub>	Reset delay time	V <sub>S</sub> = 13.5 V, C <sub>tr</sub> = 1 nF	2	4	6	ms

Table 7. Enable

Pin	Symbol	Parameter	Test condition	Min.	Typ.	Max.	Unit
E <sub>n</sub>	V <sub>En_low</sub>	E <sub>n</sub> input low voltage				1	V
E <sub>n</sub>	V <sub>En_high</sub>	E <sub>n</sub> input high voltage		3			V
E <sub>n</sub>	V <sub>En_hyst</sub>	E <sub>n</sub> input hysteresis			500		mV
E <sub>n</sub>	I <sub>leak</sub>	Pull down current	V <sub>En</sub> = 5 V		3	10	μA

## 2.4 Electrical characteristics curves

**Figure 3. Output voltage vs  $T_j$**

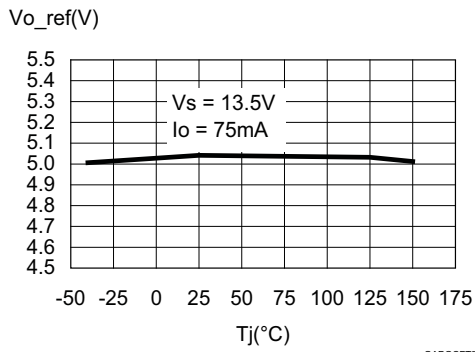

GAPGCF00090

**Figure 4. Output voltage vs  $V_s$**

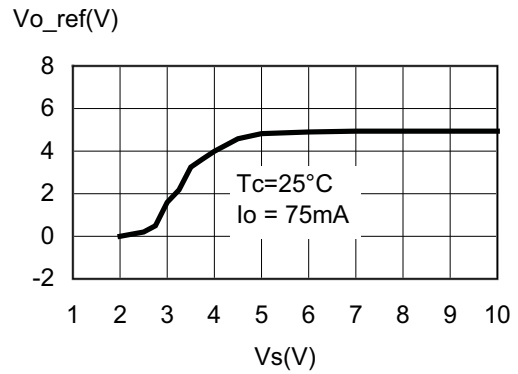

GAPGCF00091

**Figure 5. Output voltage vs  $V_{En}$**

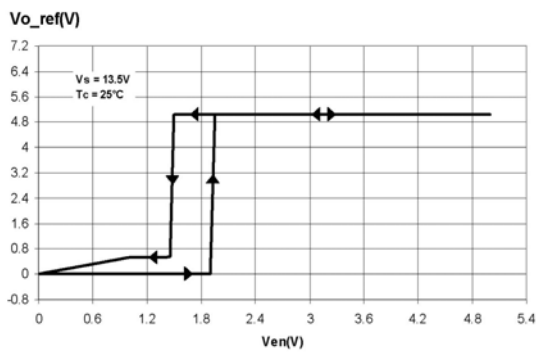

GAPGCF00092

**Figure 6. Drop voltage vs output current**

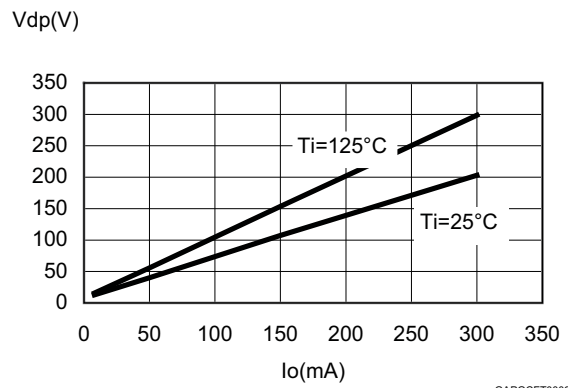

GAPGCF00093

**Figure 7. Current consumption vs output current**

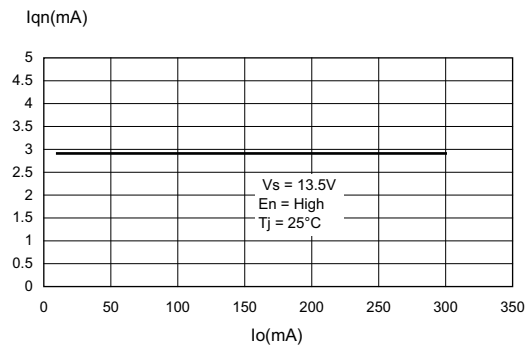

GAPGCFT00095

**Figure 8. Current consumption vs output current (at light load condition)**

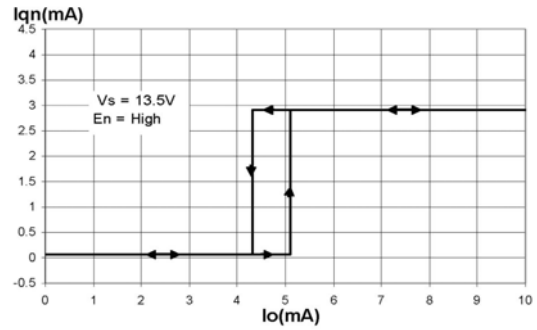

GAPGCFT00096

**Figure 9. Current consumption vs input voltage (Io = 0.1 mA)**

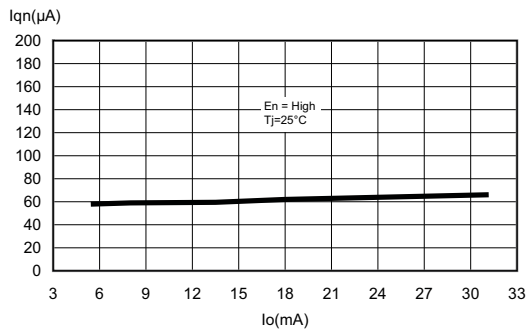

GAPGCFT00097

**Figure 10. Current consumption vs input voltage (Io = 100 mA)**

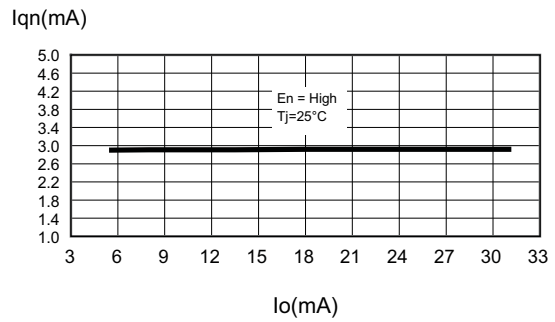

GAPGCFT00098

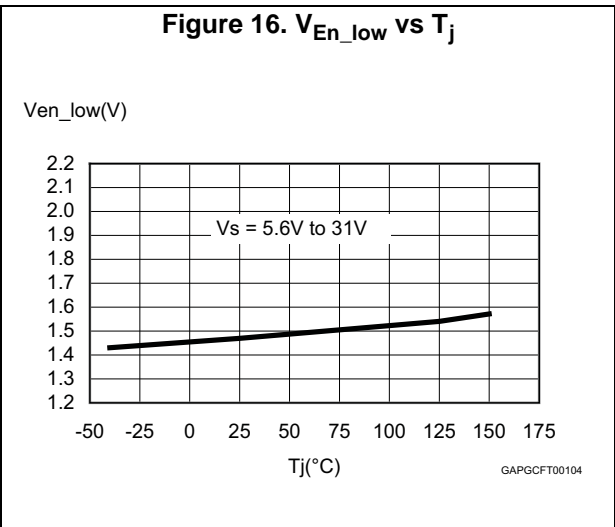
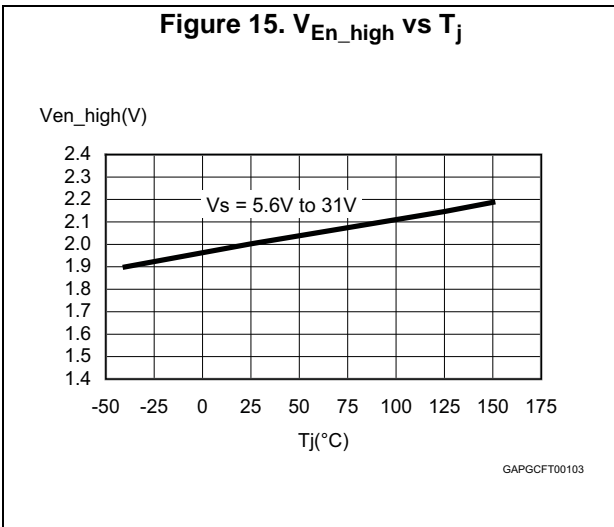
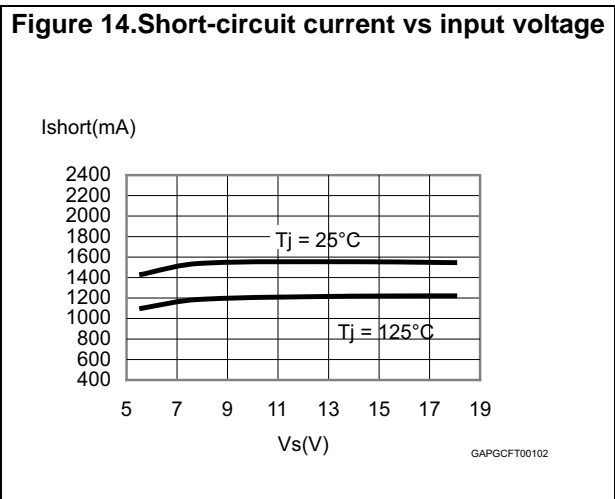
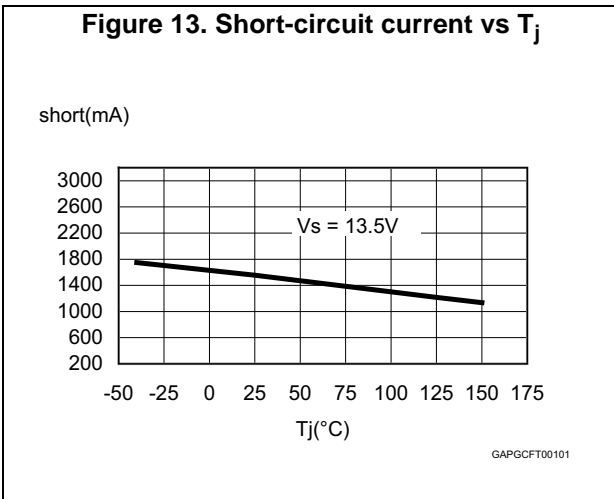
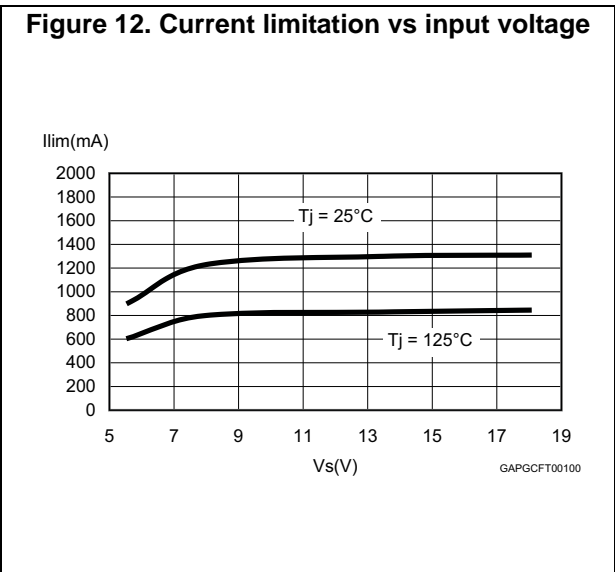
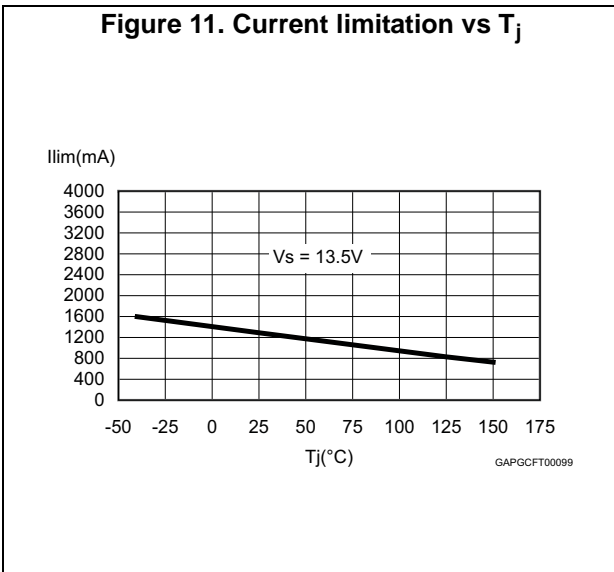

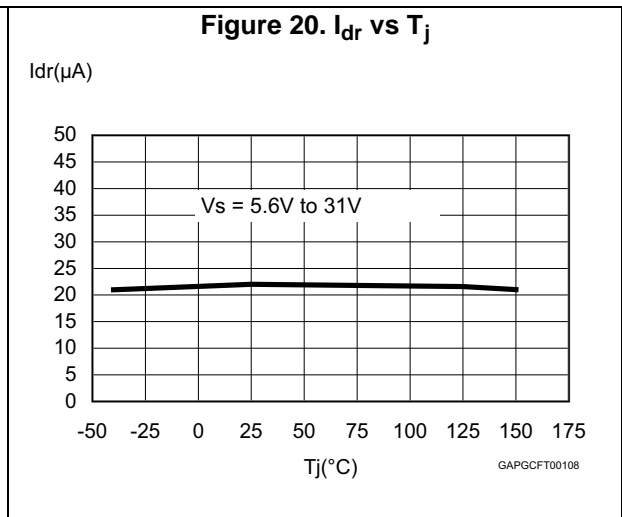
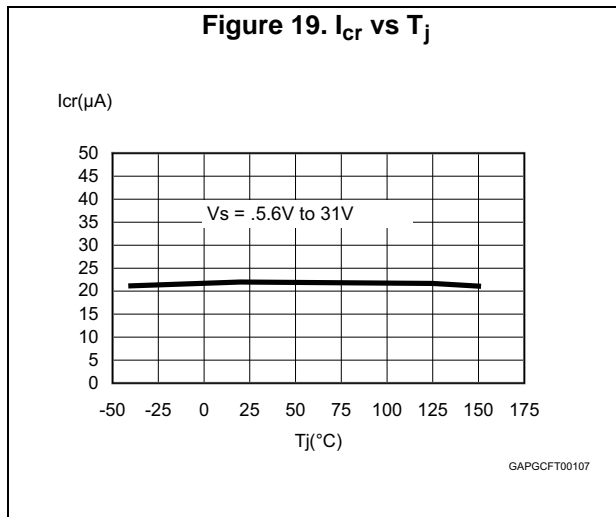
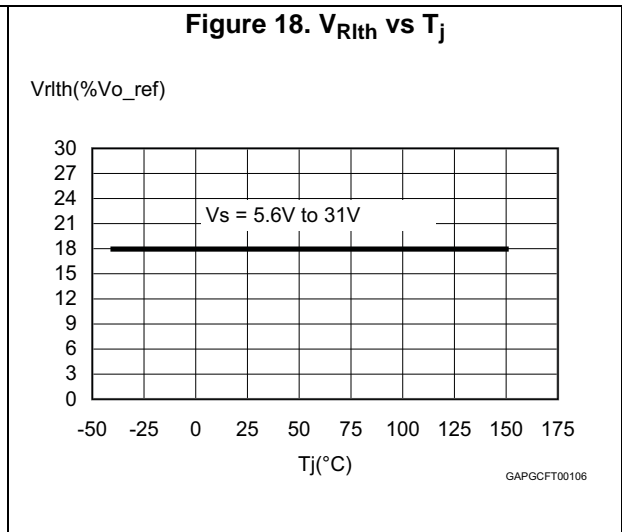
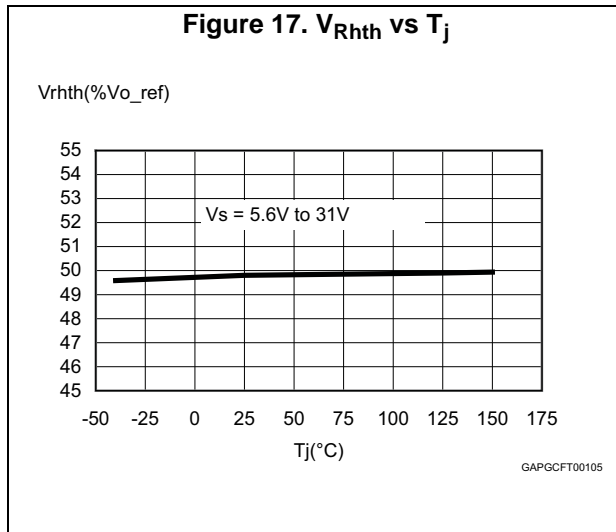

## 3 Application information

### 3.1 Voltage regulator

The voltage regulator uses a P-channel MOS transistor as a regulating element. With this structure a very low dropout voltage at current up to 300 mA is obtained. The output voltage is regulated up to input supply voltage of 40 V. The high-precision of the output voltage ( $\pm 2\%$ ) is obtained with a pre-trimmed reference voltage. The voltage regulator automatically adapts its own quiescent current to the output current level. In light load conditions the quiescent current goes down to 55  $\mu\text{A}$  only (low consumption mode). This procedure features a certain hysteresis on the output current (see [Figure 8](#)). Short-circuit protection to GND and a thermal shutdown are provided.

Figure 21. Application schematic

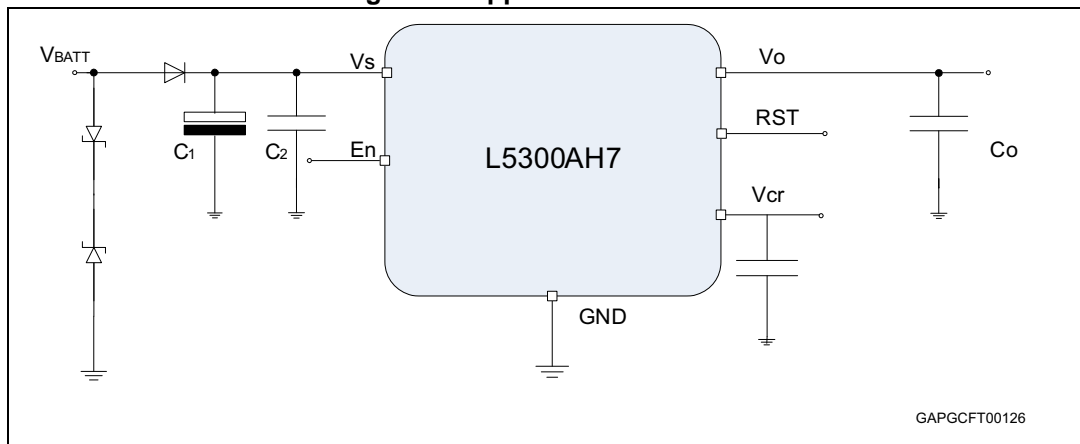

The input capacitor  $C_1 \geq 100 \mu\text{F}$  is necessary as backup supply for negative pulses which may occur on the line. The second input capacitor  $C_2 \geq 220 \text{ nF}$  is needed when the  $C_1$  is too distant from the  $V_S$  pin and it compensates smooth line disturbances. The  $C_0$  ceramic capacitor, connected to the output pin, is for bypassing to GND the high-frequency noise and it guarantees stability even during sudden line and load variations. Suggested value is  $C_0 = 220 \text{ nF}$  with  $\text{ESR} \geq 100 \text{ m}\Omega$ .

Stability region is reported in [Figure 22](#).

Figure 22. Stability region

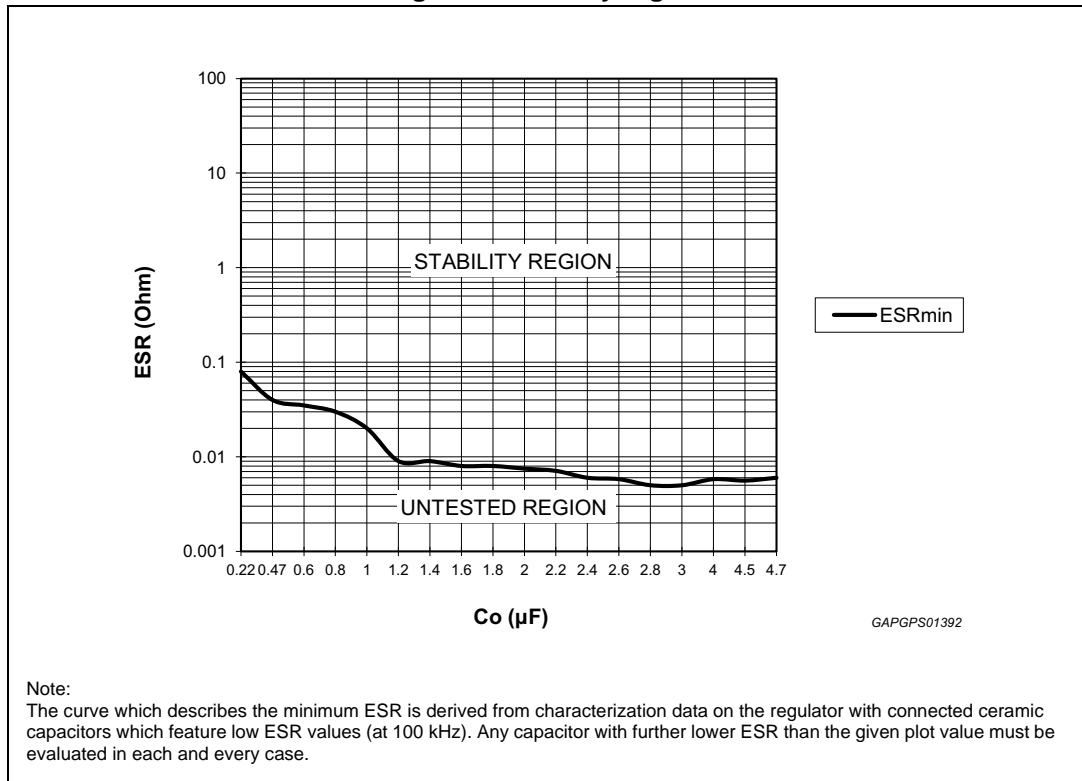
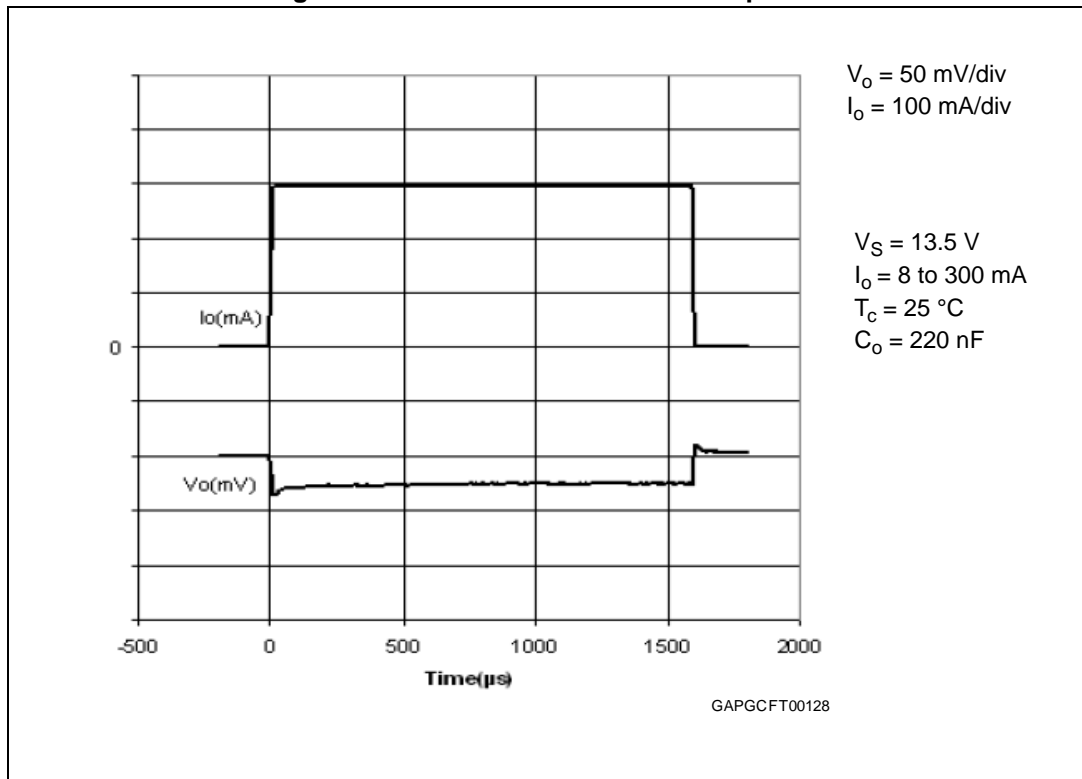

Figure 23. Maximum load variation response



### 3.2 Reset

The reset circuit monitors the output voltage  $V_o$ . If the output voltage becomes lower than  $V_{o\_th}$  then  $R_{es}$  goes low with a delay time ( $t_{rr}$ ). When the output voltage becomes higher than  $V_{o\_th}$  then  $R_{es}$  goes high with a delay time  $T_{rd}$ . This delay is obtained by 512 periods of oscillator. The oscillator period is given by:

**Equation 1**

$$T_{osc} = [(V_{Rthh} - V_{Rlth}) \times C_{tr}] / I_{cr} + [(V_{Rthh} - V_{Rlth}) \times C_{tr}] / I_{dr}$$

and reset pulse delay  $T_{rd}$  is given by:

**Equation 2**

$$t_{rd} = 32 \times T_{osc}$$

Where:

$I_{cr} = 20 \mu A$  is an internally generated charge current,

$I_{dr} = 20 \mu A$  is an internally generated discharge current,

$V_{Rthh} = 2.5V$  (typ) and  $V_{Rlth} = 0.95V$  (typ) are two voltage thresholds,

$C_{tr}$  is an external capacitor put between  $V_{cr}$  pin and GND.

**Figure 24. Reset time diagram**

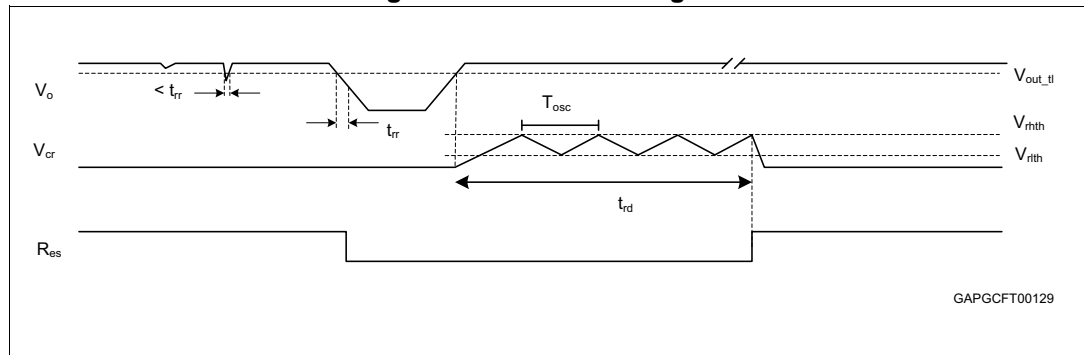

### 3.3 Enable

L5300AH7 is also provided by an enable input, a high signal switches the regulator ON. In standby mode the output is disabled and the current consumption of the device (quiescent current) is less than  $10 \mu A$ .



## 4 Package and PC board thermal data

### 4.1 HPAK thermal data

Figure 25.PC board

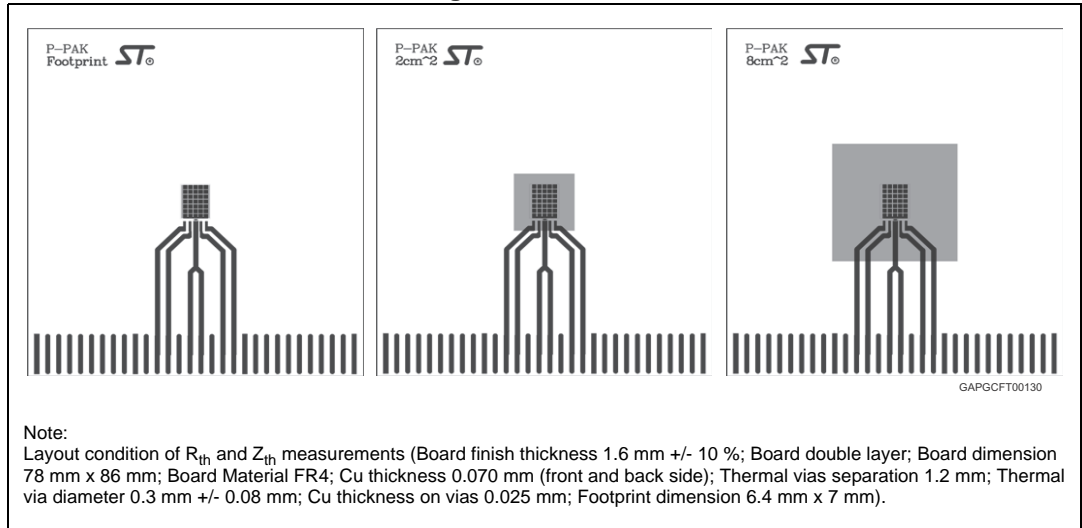

Figure 26.  $R_{thj-amb}$  vs PCB copper area in open box free air condition

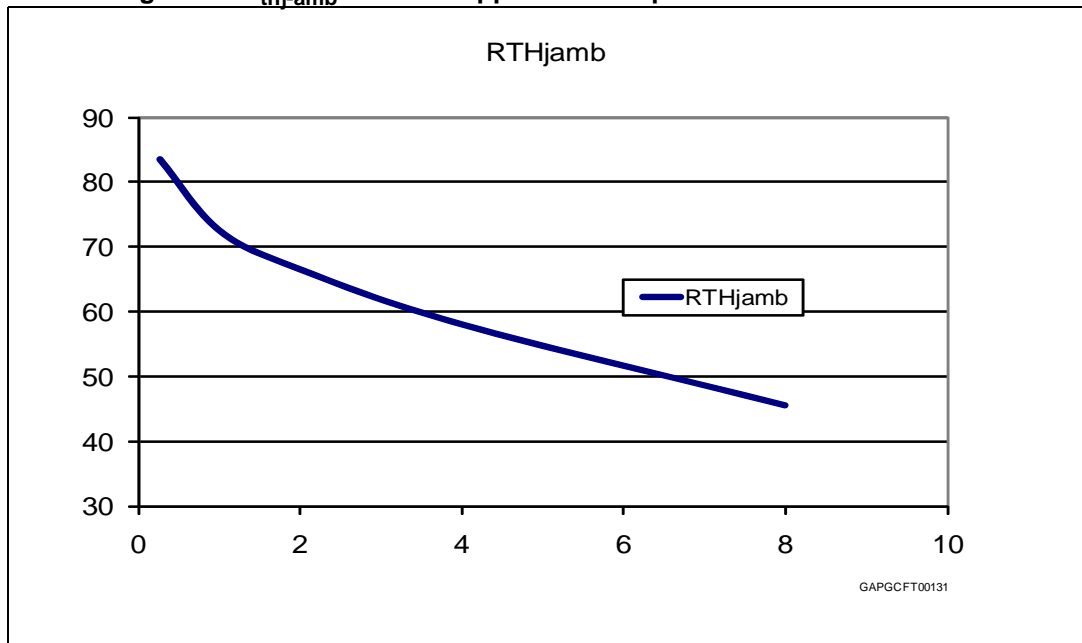

Figure 27.HPAK thermal impedance junction ambient single pulse

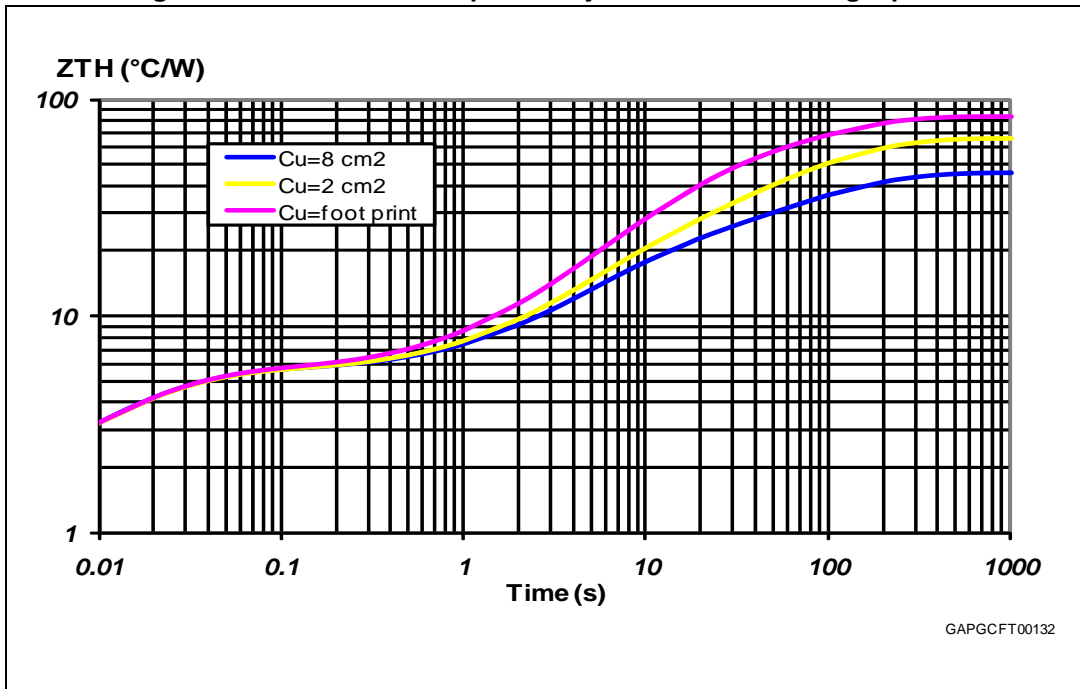
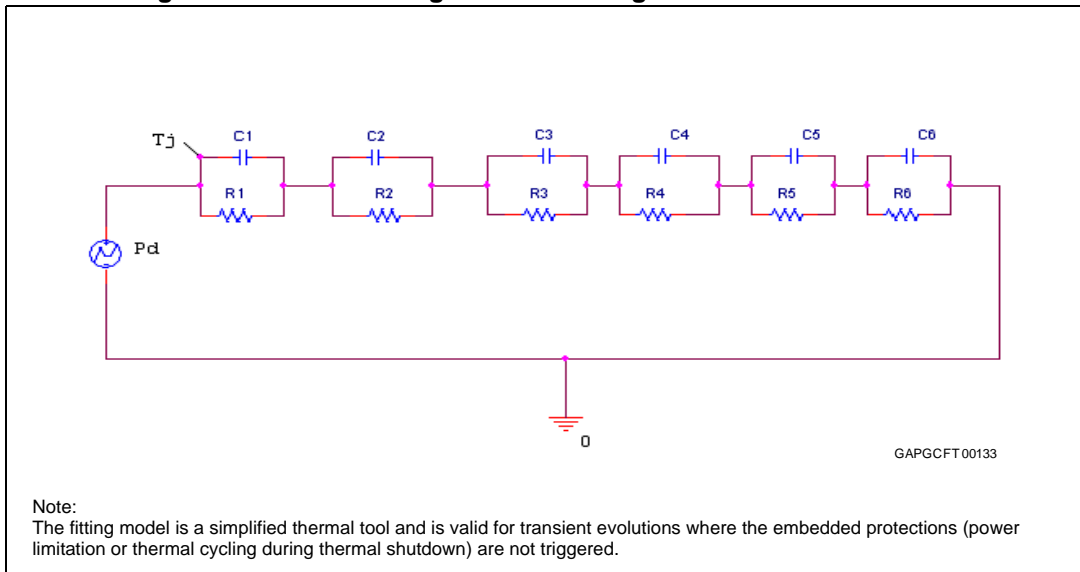

Figure 28.Thermal fitting model of a single-channel HSD in HPAK



**Equation 3: pulse calculation formula**

$$Z_{TH\delta} = R_{TH} \cdot \delta + Z_{THtp}(1 - \delta)$$

where  $\delta = t_p/T$

**Table 8. Thermal parameter**

Area/island (cm <sup>2</sup> )	Footprint	4	8
R1 (°C/W)	3		
R2 (°C/W)	4		
R3 (°C/W)	6		
R4 (°C/W)	7		
R5 (°C/W)	28	18.5	11
R6 (°C/W)	31	22	14
C1 (W.s/°C)	0.0005		
C2 (W.s/°C)	0.001		
C3 (W.s/°C)	0.005		
C4 (W.s/°C)	0.05		
C5 (W.s/°C)	0.8	2	3
C6 (W.s/°C)	3	6	9

## 5 Package and packing information

### 5.1 ECOPACK®

In order to meet environmental requirements, ST offers these devices in different grades of ECOPACK® packages, depending on their level of environmental compliance. ECOPACK® specifications, grade definitions and product status are available at: [www.st.com](http://www.st.com). ECOPACK® is an ST trademark.

### 5.2 HPAK mechanical data

Figure 29.HPAK dimension

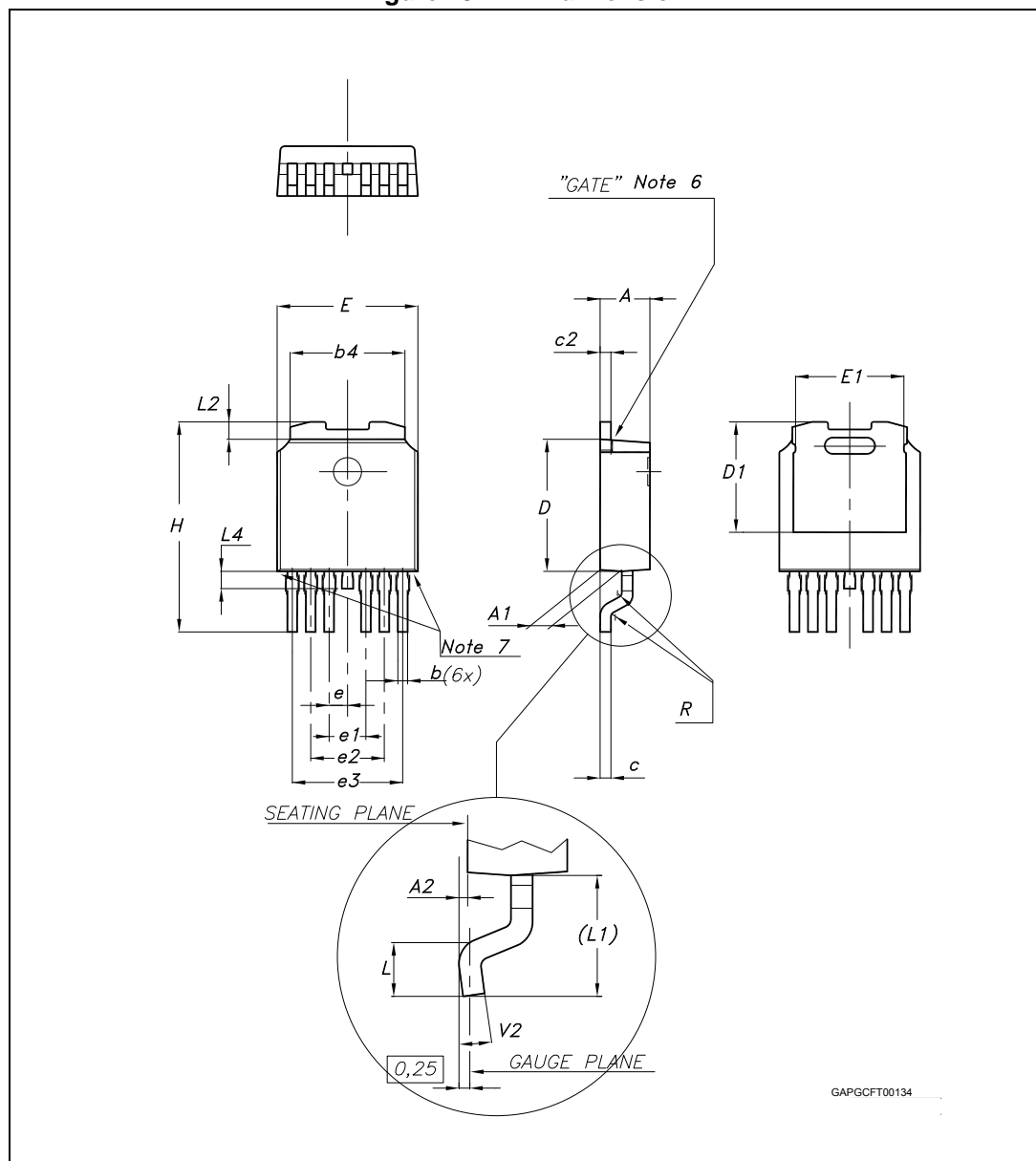

Table 9. HPAK mechanical data

Dim	Millimeter		
	Nom	Min	Max
A		2.20	2.40
A1		0.90	1.10
A1		0.03	0.23
b		0.45	0.60
b4		5.20	5.40
c		0.45	0.60
c2		0.48	0.60
D		6.00	6.20
D1	5.10		
E		6.40	6.60
E1	5.20		
e	0.85		
e1		1.60	1.80
e2		3.30	3.50
e3		5.00	5.20
H		9.35	10.10
L		1	
(L1)	2.80		
L2	0.80		
L4		0.60	1.00
R	0.20		
V2		0°	8°

## 6 Revision history

**Table 10. Document revision history**

Date	Revision	Changes
09-Aug-2007	1	Initial release.
15-Oct-2007	2	Changed features table on the cover page: - quiescent current with regulator disabled changed from 10 to 5 $\mu\text{A}$ . - quiescent current with regulator enabled changed from 60 to 55 $\mu\text{A}$ . <a href="#">Table 5: General</a> - Added typical value of $I_{\text{qs}}$ and $I_{\text{qn}_1}$ parameters.
12-Mar-2009	3	Changed features table on the cover page <a href="#">Table 5: General</a> - $V_{\text{o\_ref}}$ : deleted row and added 3 new rows <a href="#">Table 6: Reset</a> - $I_{\text{Res\_lkg}}$ : deleted Test condition - $V_{\text{o\_th}}$ : deleted $I_{\text{O}} = 1$ to 300 mA and $V_{\text{S}} = 5.6$ to 31V, added " $V_{\text{O}}$ decreasing" for test condition - $V_{\text{Rlth}}$ : changed min/typ/max values - $T_{\text{rd}}$ : changed min/typ/max values Updated <a href="#">Table 7: Enable</a> <a href="#">Section 3.2: Reset</a> - $t_{\text{rd}}$ : changed coefficient - $V_{\text{Rlth}}$ : changed coefficient
23-Jul-2010	4	Changed status from target specification to preliminary data. Updated following tables: - <a href="#">Table 4: Thermal data</a> - <a href="#">Table 5: General</a> Added <a href="#">Section 2.4: Electrical characteristics curves</a> . Added <a href="#">Chapter 4: Package and PC board thermal data</a>
02-Sep-2010	5	Updated <a href="#">Figure 27: HPAK thermal impedance junction ambient single pulse</a>
15-Sep-2010	6	Updated <a href="#">Table 4: Thermal data</a>
12-Oct-2010	7	Updated <a href="#">Section 3.1: Voltage regulator</a>

Table 10. Document revision history (continued)

Date	Revision	Changes
09-Mar-2011	8	<p>Updated following tables:</p> <p><i>Table 2: Pins description:</i></p> <ul style="list-style-type: none"> <li>– Updated pins sequence</li> </ul> <p><i>Table 3: Absolute maximum ratings:</i></p> <ul style="list-style-type: none"> <li>– <math>I_{sdc}</math>: changed symbol from <math>I_{VsdC}</math></li> <li>– <math>I_{odc}</math>: changed symbol from <math>I_{VodC}</math></li> </ul> <p><i>Table 5: General:</i></p> <ul style="list-style-type: none"> <li>– <math>I_{short}</math>: changed min/typ/max value</li> <li>– <math>I_{lim}</math>: changed min/typ/max value, changed parameter</li> <li>– <math>V_{line}</math>: changed test condition</li> <li>– <math>I_{qn\_300}</math>: changed typ value</li> <li>– Updated tablefootnote</li> </ul> <p><i>Table 6: Reset:</i></p> <ul style="list-style-type: none"> <li>– <math>V_{Res\_I}</math>: changed test condition</li> <li>– <math>V_{Res\_Ikg}</math>: added test condition</li> </ul> <p><i>Table 7: Enable:</i></p> <ul style="list-style-type: none"> <li>– <math>I_{leak}</math>: changed typ value</li> </ul> <p>Updated <i>Section 3.2: Reset</i></p>
18-Nov-2011	9	<p><i>Table 9: HPAK mechanical data:</i></p> <ul style="list-style-type: none"> <li>– b: updated values</li> </ul>
26-Jan-2012	10	Updated <i>Figure 22: Stability region on page 15.</i>
07-Feb-2012	11	Modified <i>Figure 22: Stability region on page 15.</i>
13-Sep-2013	12	Updated disclaimer.
21-Sep-2018	13	Updated template. Updated title and <i>Features.</i>