

Automotive 5 V low drop voltage regulator

Datasheet - production data

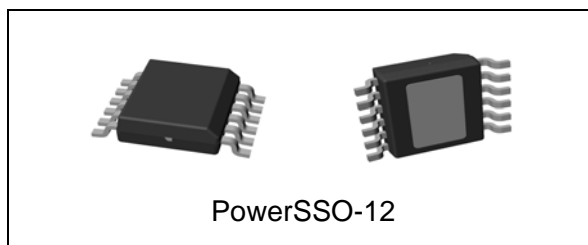

- Programmable reset pulse delay with external capacitor
- Early warning
- Very wide stability range with low value output capacitor
- Thermal shutdown and short circuit protection
- Wide temperature range ($T_j = -40\text{ }^\circ\text{C}$ to $150\text{ }^\circ\text{C}$)
- Enable input for enabling / disabling the voltage regulator

Features

| | | |
|------------------------------|--------------|---|
| Max DC supply voltage | V_S | 40 V |
| Max output voltage tolerance | ΔV_0 | +/-2% |
| Max dropout voltage | V_{dp} | 500 mV |
| Output current | I_0 | 300 mA |
| Quiescent current | I_{qn} | 5 $\mu\text{A}^{(1)}$ 55 $\mu\text{A}^{(2)}$ |

1. Typical value with regulator disabled.
2. Typical value with regulator enabled.

- AEC-Q100 qualified 
- Operating DC supply voltage range
- 5.6 V to 40 V
- Low dropout voltage
- 300 mA current capability
- Low quiescent current
- Very low consumption mode
- Precision output voltage 5 V +/- 2%
- Reset circuit sensing the output voltage

Description

L5300GJ is a low dropout linear regulator with microprocessor control functions such as power on reset, low voltage reset, early warning, ON/OFF control. Typical quiescent current is 55 μA in very low output current mode and enabled regulator. It drops to 5 μA with not enabled regulator.

On-chip trimming results in high output voltage accuracy (2%). Accuracy is kept over wide temperature range, line and load variation. Early warning circuit monitors the input voltage and compares it with an internal voltage reference.

The maximum input voltage is 40 V. The maximum output current is internally limited.

Internal temperature protection disables the voltage regulator output. In addition, only low value ceramic capacitor on output is required for stability (equal or above 220 nF).

Table 1. Device summary

| Package | Order codes | |
|-------------|-------------|---------------|
| | Tube | Tape and reel |
| PowerSSO-12 | L5300GJ | L5300GJTR |

Contents

- 1 Block diagram and pins description 5**

- 2 Electrical specifications 7**
 - 2.1 Absolute maximum ratings 7
 - 2.2 Thermal data 7
 - 2.3 Electrical characteristics 8
 - 2.4 Electrical characteristics curves 10

- 3 Application information 14**
 - 3.1 Voltage regulator 14
 - 3.2 Reset 16
 - 3.3 Early warning 16
 - 3.4 Enable 17

- 4 Package and PCB thermal data 18**

- 5 Package and packing information 21**
 - 5.1 ECOPACK® 21
 - 5.2 PowerSSO-12 mechanical data 21
 - 5.3 PowerSSO-12 packing information 23

- 6 Revision history 24**

List of tables

| | | |
|-----------|---|----|
| Table 1. | Device summary | 1 |
| Table 2. | Pins description | 6 |
| Table 3. | Absolute maximum ratings | 7 |
| Table 4. | Thermal data | 7 |
| Table 5. | General | 8 |
| Table 6. | Reset | 9 |
| Table 7. | Early warning | 9 |
| Table 8. | Enable. | 9 |
| Table 9. | PowerSSO-12 thermal parameter | 20 |
| Table 10. | PowerSSO-12 mechanical data | 22 |
| Table 11. | Document revision history | 24 |

List of figures

| | | |
|------------|--|----|
| Figure 1. | Block diagram | 5 |
| Figure 2. | Configuration diagram (top view) | 5 |
| Figure 3. | Output voltage vs T_j | 10 |
| Figure 4. | Output voltage vs V_S | 10 |
| Figure 5. | Output voltage vs V_{En} | 10 |
| Figure 6. | Drop voltage vs. output current | 10 |
| Figure 7. | Current consumption vs. output current | 10 |
| Figure 8. | Current consumption vs. output current (at light load condition) | 10 |
| Figure 9. | Current consumption vs input voltage ($I_o = 0.1$ mA) | 11 |
| Figure 10. | Current consumption vs input voltage ($I_o = 100$ mA) | 11 |
| Figure 11. | Current limitation vs T_j | 11 |
| Figure 12. | Current limitation vs input voltage | 11 |
| Figure 13. | Short-circuit current vs T_j | 11 |
| Figure 14. | Short-circuit current vs input voltage | 11 |
| Figure 15. | V_{En_high} vs T_j | 12 |
| Figure 16. | V_{En_low} vs T_j | 12 |
| Figure 17. | V_{Rth} vs T_j | 12 |
| Figure 18. | V_{Rlth} vs T_j | 12 |
| Figure 19. | V_{EWi_thh} vs T_j | 12 |
| Figure 20. | V_{EWi_thl} vs T_j | 12 |
| Figure 21. | I_{cr} vs T_j | 13 |
| Figure 22. | I_{dr} vs T_j | 13 |
| Figure 23. | Application schematic | 14 |
| Figure 24. | Stability region | 15 |
| Figure 25. | Maximum load variation response | 15 |
| Figure 26. | Reset time diagram | 16 |
| Figure 27. | Early warning time diagram | 17 |
| Figure 28. | PowerSSO-12 PC board ⁽¹⁾ | 18 |
| Figure 29. | $R_{thj-amb}$ Vs. PCB copper area in open box free air condition | 18 |
| Figure 30. | PowerSSO-12 thermal impedance junction ambient single pulse | 19 |
| Figure 31. | Thermal fitting model of V_{reg} in in PowerSSO-12 | 19 |
| Figure 32. | PowerSSO-12 package dimensions | 21 |
| Figure 33. | PowerSSO-12 tube shipment (no suffix) | 23 |
| Figure 34. | PowerSSO-12 tape and reel shipment (suffix "TR") | 23 |

1 Block diagram and pins description

Figure 1. Block diagram

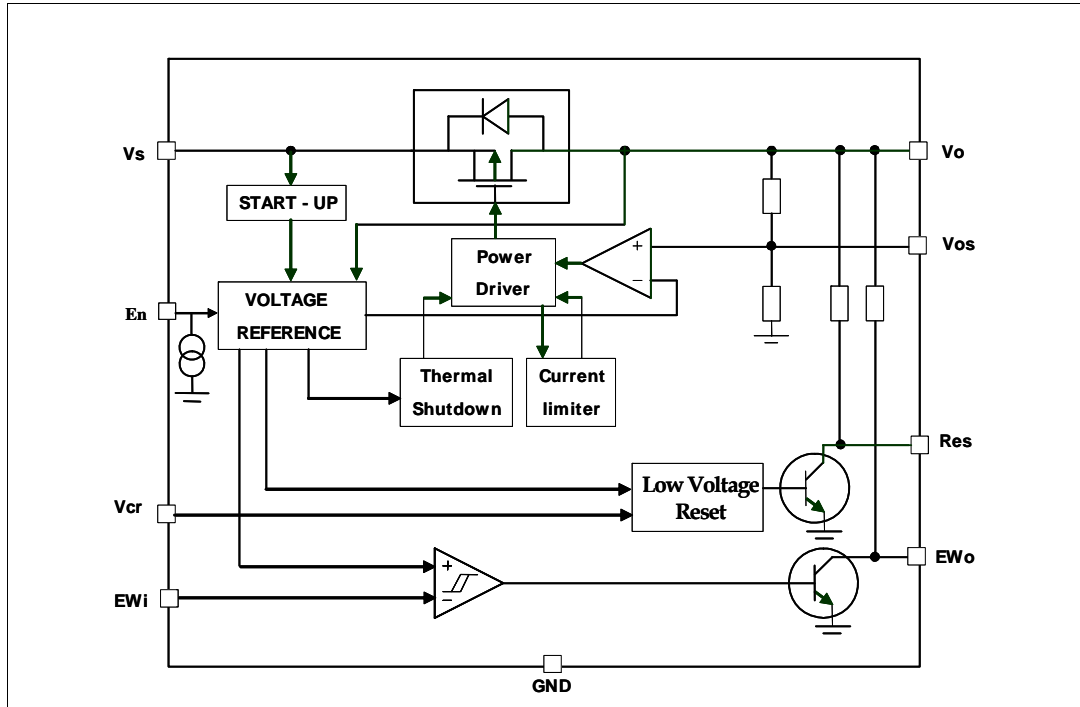

Figure 2. Configuration diagram (top view)

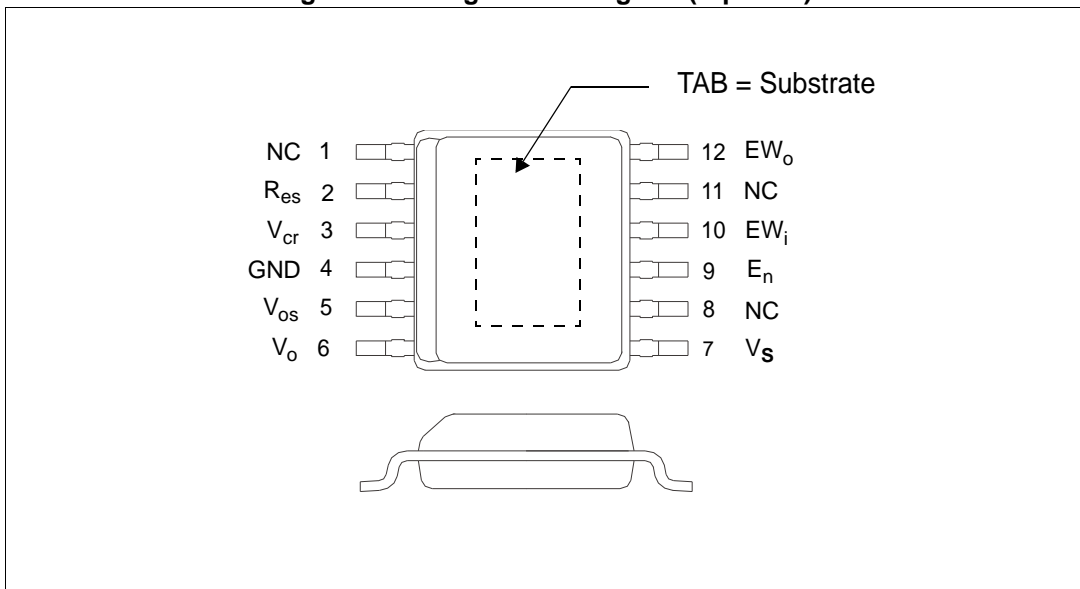

Table 2. Pins description

| N° | Name | Function |
|----|-----------------|--|
| 1 | NC | Not connected |
| 2 | R _{es} | Reset output. Internally connected to V _o through a 20 KΩ pull up resistor. This pin is pulled low when V _o < V _{o_th} . Keep open if not needed |
| 3 | V _{cr} | Reset delay. Connect an external capacitor between V _{cr} pin and ground to adjust the reset delay time. Keep open if not needed |
| 4 | GND | Ground reference |
| 5 | V _{os} | Regulator output voltage sensing (connect to V _o) |
| 6 | V _o | 5 V regulated output. Block to GND with a ceramic capacitor (C _o ≥ 220 nF for regulator stability) |
| 7 | V _S | Supply voltage, block directly to GND on the IC with a capacitor |
| 8 | NC | Not connected |
| 9 | E _n | Enable input. A high signal switches the regulator ON. Connect to V _S if not needed |
| 10 | EW _i | Early warning input. This pin monitors the V _S voltage level through a resistor divider. Connect to V _S if not needed |
| 11 | NC | Not connected |
| 12 | EW _o | Early warning output. Internally connected to V _o through 20 KΩ pull up resistor. This pin is pulled low when EW _i is below bandgap reference voltage. Keep open if not needed |
| - | TAB | TAB is connected to the substrate of the chip: connect to GND or leave open (see Figure 2). |

2 Electrical specifications

2.1 Absolute maximum ratings

Stressing the device above the rating listed in the [Table 3: Absolute maximum ratings](#) may cause permanent damage to the device. These are stress ratings only and operation of the device at these or any other conditions above those indicated in the operating sections of this specification is not implied. Exposure to absolute maximum rating conditions for extended periods may affect device reliability.

Table 3. Absolute maximum ratings

| Symbol | Parameter | Value | Unit |
|---------------|--|-------------------------|------|
| V_{sdc} | DC supply voltage | -0.3 to 40 | V |
| I_{Vsdc} | Input current | Internally limited | |
| V_{odc} | DC output voltage | -0.3 to 6 | V |
| I_{Vodc} | DC output current | Internally limited | |
| $V_{od Res}$ | Open drain output voltage R_{es} | -0.3 to $V_{odc} + 0.3$ | V |
| $I_{od Res}$ | Open drain output current R_{es} | Internally limited | |
| $V_{od EW_o}$ | Open drain output voltage EW_o | -0.3 to $V_{odc} + 0.3$ | V |
| $I_{od EW_o}$ | Open drain output current EW_o | Internally limited | |
| V_{cr} | V_{cr} voltage | -0.3 to $V_o + 0.3$ | V |
| V_{EWi} | Early warning input voltage | -0.3 to 40 | V |
| V_{En} | Enable input | -0.3 to 40 | V |
| T_j | Junction temperature | -40 to 150 | °C |
| $V_{ESD HBM}$ | ESD HBM voltage level (HBM-MIL STD 883C) | +/- 2 | kV |
| $V_{ESD CDM}$ | ESD CDM voltage level (CDM AEC-Q100-011) | +/- 750 | V |

2.2 Thermal data

Table 4. Thermal data

| Symbol | Parameter | Value | Unit |
|----------------|---|-------|------|
| $R_{thj-case}$ | Thermal resistance junction to case: PowerSSO-12 | 8 | °K/W |
| $R_{thj-amb}$ | Thermal resistance junction to ambient: PowerSSO-12 | 48 | °K/W |

Note: The values quoted are for PCB 77mm x 86 mm x 1.6mm, FR4, double layer with thermal vias (one copper heatsink layer, thickness 0.070 mm, area 8 cm²).

2.3 Electrical characteristics

Values specified in this section are for $V_S = 5.6\text{ V to }31\text{ V}$, $T_j = -40^\circ\text{C to }150^\circ\text{C}$ unless otherwise stated.

Table 5. General

| Pin | Symbol | Parameter | Test condition | Min. | Typ. | Max. | Unit |
|------------|-----------------|---|---|------|------|------|------------------|
| V_o | V_{o_ref} | Output voltage | $V_S = 8\text{ V to }18\text{ V}$; $I_o = 8\text{ mA to }300\text{ mA}$ | 4.9 | 5.0 | 5.1 | V |
| V_o | V_{o_ref} | Output voltage | $V_S = 5.6\text{ V to }31\text{ V}$; $I_o = 8\text{ mA to }300\text{ mA}$ | 4.85 | 5.0 | 5.15 | V |
| V_o | V_{o_ref} | Output voltage | $V_S = 5.6\text{ V to }31\text{ V}$; $I_o = 0.1\text{ mA to }8\text{ mA}$ | 4.75 | 5.0 | 5.25 | V |
| V_o | I_{short} | Short circuit current | $V_S = 13.5\text{ V}$ | 0.8 | 1.8 | 2.6 | A |
| V_o | I_{lim} | Output current capability ⁽¹⁾ | $V_S = 13.5\text{ V}$ | 0.6 | 1.6 | 2.5 | A |
| V_S, V_o | V_{line} | Line regulation voltage | $V_S = 6\text{ V to }28\text{ V}$; $I_o = 60\text{ mA}$ | | | 40 | mV |
| V_o | V_{load} | Load regulation voltage | $V_S = 13.5\text{ V}$; $I_o = 8\text{ mA to }300\text{ mA}$; $T_j = 25^\circ\text{C}$ | | | 40 | mV |
| | | | $V_S = 8\text{ V to }18\text{ V}$; $I_o = 8\text{ mA to }300\text{ mA}$ | | | 55 | |
| V_S, V_o | V_{dp} | Drop voltage ⁽²⁾ | $I_o = 300\text{ mA}$ | | | 500 | mV |
| V_S, V_o | SVR | Ripple rejection | $f_r = 100\text{ Hz}$ ⁽³⁾ | | 60 | | dB |
| V_o | I_{oth_H} | Normal consumption mode output current | | 8 | | | mA |
| V_o | I_{oth_L} | Very low consumption mode output current | | | | 1.1 | mA |
| V_o | I_{oth_Hyst} | Output current switching threshold hysteresis | $V_S = 13.5\text{ V}$; $T_j = 25^\circ\text{C}$ | | 0.8 | | mA |
| V_S, V_o | I_{qs} | Current consumption with regulator disabled $I_{qs} = I_{V_S} - I_o$ | $V_S = 13.5\text{ V}$; $E_n = \text{low}$ | | 5 | 10 | μA |
| V_S, V_o | I_{qn_1} | Current consumption with regulator enabled $I_{qn_1} = I_{V_S} - I_o$ | $V_S = 13.5\text{ V}$; $I_o = 0.1\text{ mA to }1\text{ mA}$; $E_n = \text{high}$ | | 55 | 80 | μA |
| V_S, V_o | I_{qn_300} | Current consumption with regulator enabled $I_{qn_300} = I_{V_S} - I_o$ | $V_S = 13.5\text{ V}$; $I_o = 300\text{ mA}$; $E_n = \text{high}$ | | 3 | 4.2 | mA |
| | T_w | Thermal protection temperature | | 150 | | 190 | $^\circ\text{C}$ |
| | T_{w_hy} | Thermal protection temperature hysteresis | | | 10 | | $^\circ\text{C}$ |

1. Measured output current when the output voltage has dropped 100 mV from its nominal value obtained at 13.5 V and $I_o = 75\text{ mA}$.

2. $V_S - V_O$ measured dropout when the output voltage has dropped 100 mV from its nominal value obtained at 13.5V and $I_O = 75$ mA.
3. Guaranteed by design.

Table 6. Reset

| Pin | Symbol | Parameter | Test condition | Min. | Typ. | Max. | Unit |
|-----------------|----------------------|--|---|------|------|------|---------------------------|
| R _{es} | V _{Res_l} | Reset output low voltage | R _{ext} = 5 kΩ; V _o > 1 V | | | 0.4 | V |
| R _{es} | I _{Res_lkg} | Reset output high leakage current | V _{Res} = V _{out} | | | 1 | μA |
| R _{es} | R _{res} | Pull-up internal resistance | Versus V _o | 10 | 20 | 40 | kΩ |
| R _{es} | V _{o_th} | V _o out of regulation threshold | V _o decreasing | 6 | 8 | 10 | %below V _{o_ref} |
| V _{cr} | V _{Rlth} | Reset timing low threshold | V _S = 13.5 V | 15 | 18 | 22 | % V _{o_ref} |
| V _{cr} | V _{Rhth} | Reset timing high threshold | V _S = 13.5 V | 47 | 50 | 53 | % V _{o_ref} |
| V _{cr} | I _{cr} | Charge current | V _S = 13.5 V | 10 | 20 | 30 | μA |
| V _{cr} | I _{dr} | Discharge current | V _S = 13.5 V | 10 | 20 | 30 | μA |
| R _{es} | T _{rr} | Reset reaction time | | | | 2 | μs |
| R _{es} | T _{rd} | Reset delay time | V _S = 13.5 V; C _{tr} = 1 nF | 2 | 4 | 6 | ms |

Table 7. Early warning

| Pin | Symbol | Parameter | Test condition | Min. | Typ. | Max. | Unit |
|-----------------|-------------------------|---|--|------|------|------|------|
| EW _i | E _{wi_th_low} | EW input low threshold voltage | | 2.35 | 2.50 | 2.65 | V |
| EW _i | E _{wi_th_high} | EW input high threshold voltage | | 2.42 | 2.57 | 2.72 | V |
| EW _i | E _{wi_th_hyst} | EW input threshold hysteresis | | | 70 | | mV |
| EW _i | I _{EWi_lkg} | EW input leakage current | V _{EWi} = 0 V; V _S > 3 V | -1 | | 1 | μA |
| EW _o | R _{EWo} | Pull-up internal resistance | Versus V _o | 10 | 20 | 40 | kΩ |
| EW _o | E _{Wo_lv} | EW output low voltage (with external pull up) | V _{EWi} < 2.35 V; V _S > 4 V; R _{ext} = 5 kΩ | | | 400 | mV |
| EW _o | I _{Wo} | EW output leakage | V _{EWo} = 5 V | | | 1 | μA |

Table 8. Enable

| Pin | Symbol | Parameter | Test condition | Min. | Typ. | Max. | Unit |
|----------------|----------------------|-----------------------------------|-----------------------|------|------|------|------|
| E _n | V _{En_low} | E _n input low voltage | | | | 1 | V |
| E _n | V _{En_high} | E _n input high voltage | | 3 | | | V |
| E _n | V _{En_hyst} | E _n input hysteresis | | | 500 | | mV |
| E _n | I _{leak} | Pull-down current | V _{En} = 5 V | | 3 | 10 | μA |

2.4 Electrical characteristics curves

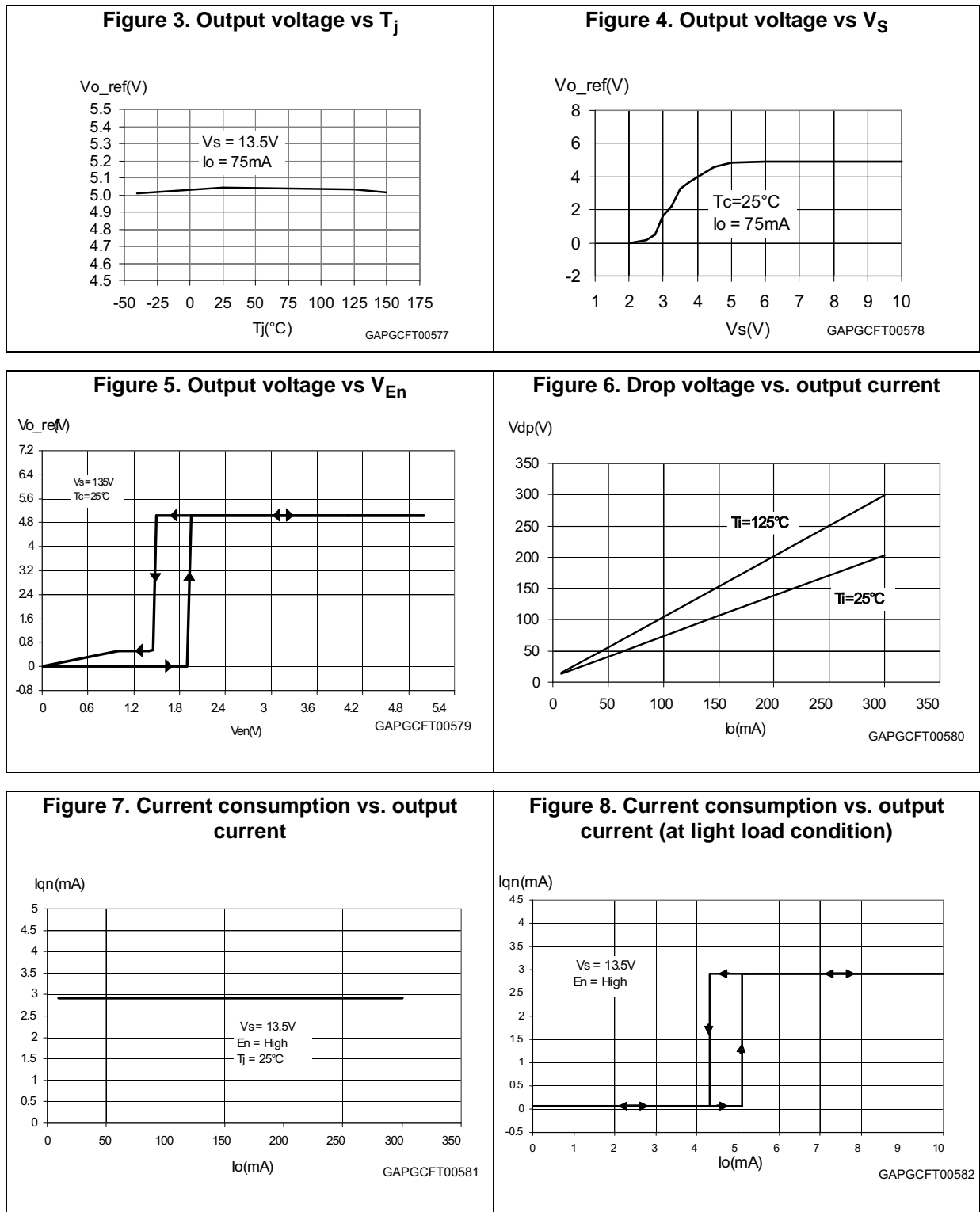

Figure 9. Current consumption vs input voltage ($I_o = 0.1 \text{ mA}$)

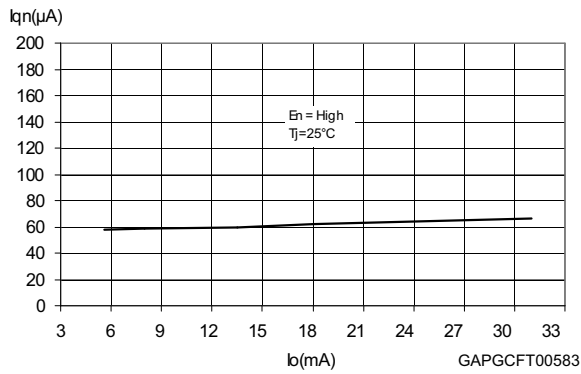

Figure 10. Current consumption vs input voltage ($I_o = 100 \text{ mA}$)

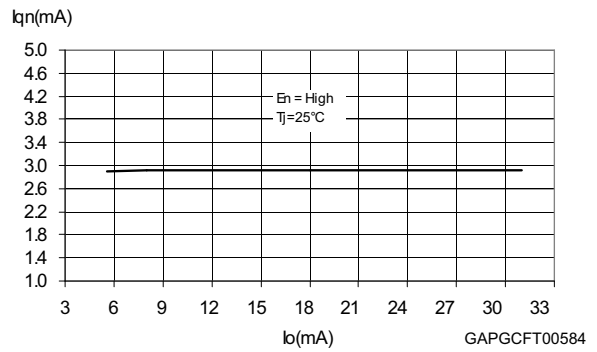

Figure 11. Current limitation vs T_j

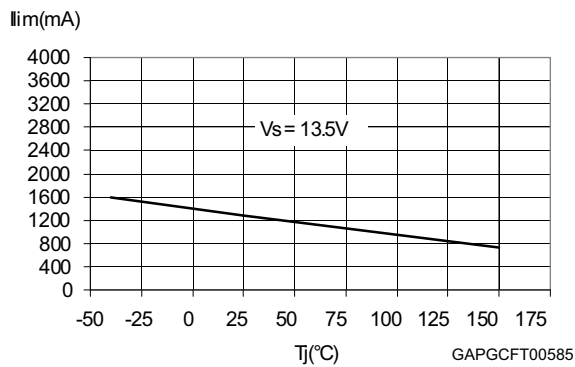

Figure 12. Current limitation vs input voltage

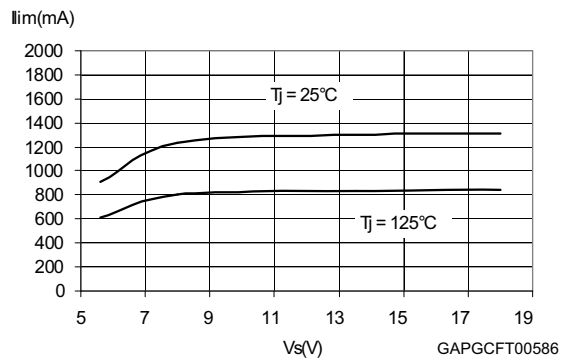

Figure 13. Short-circuit current vs T_j

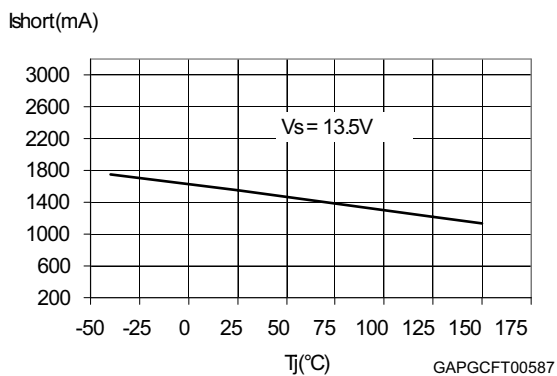
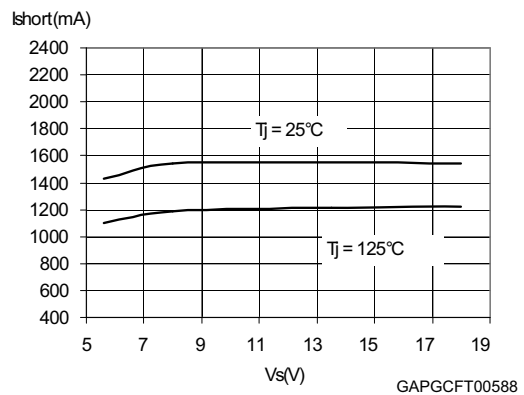
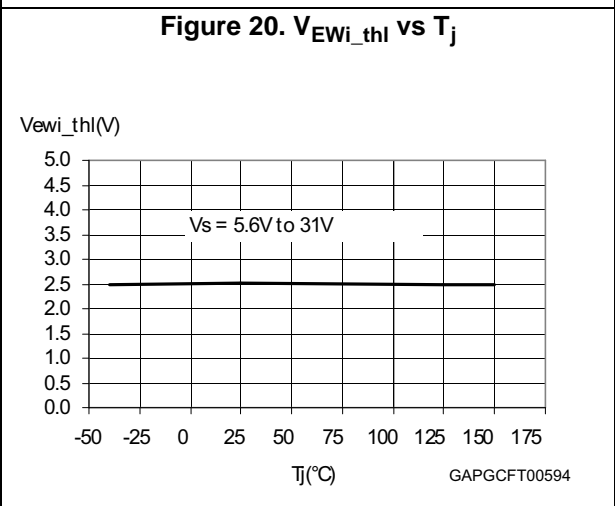
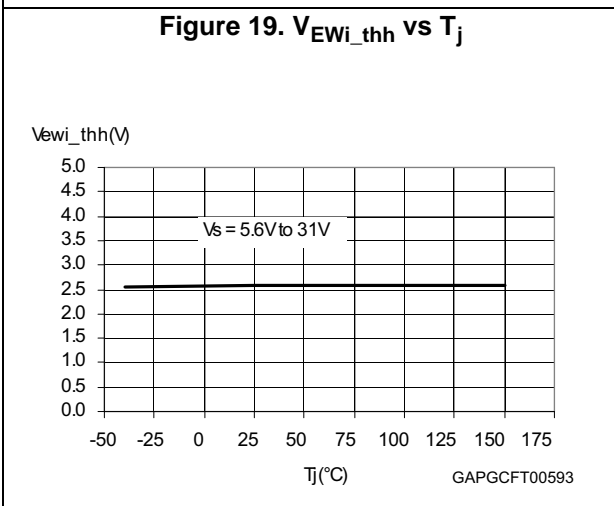
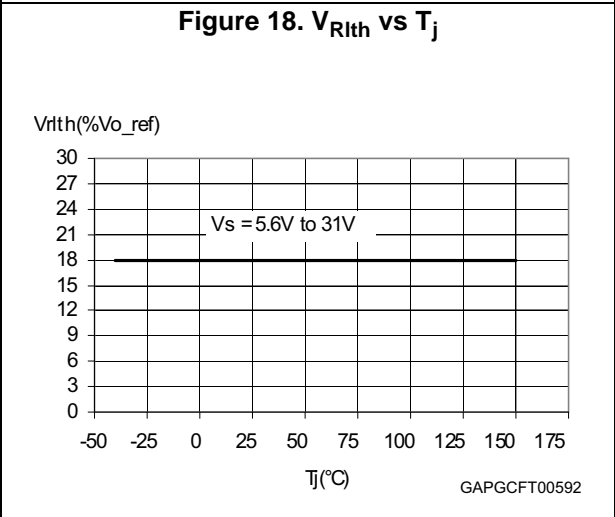
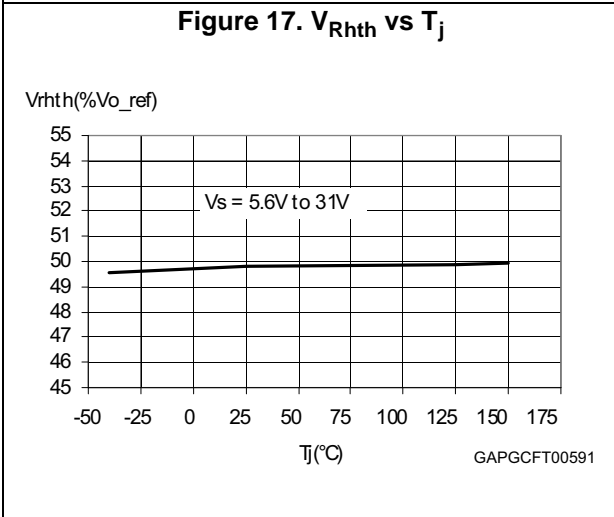
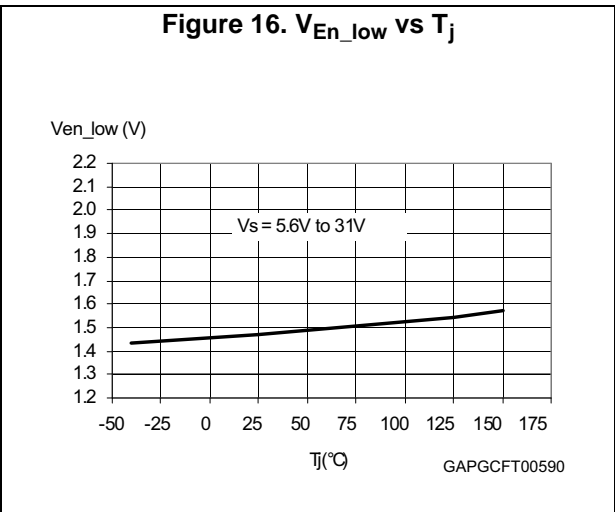
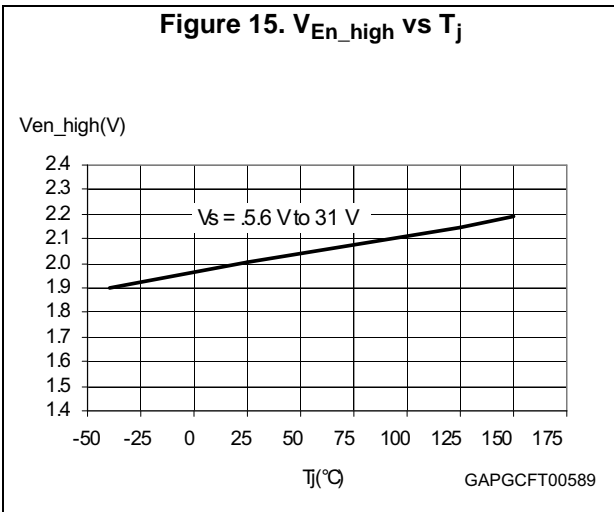

Figure 14. Short-circuit current vs input voltage





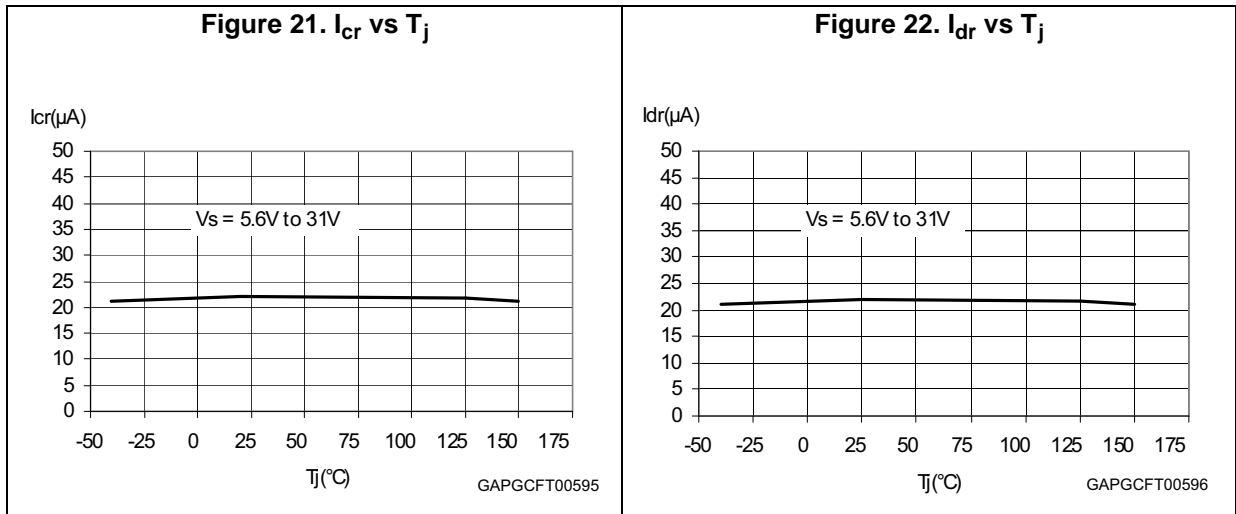

Figure 24. Stability region

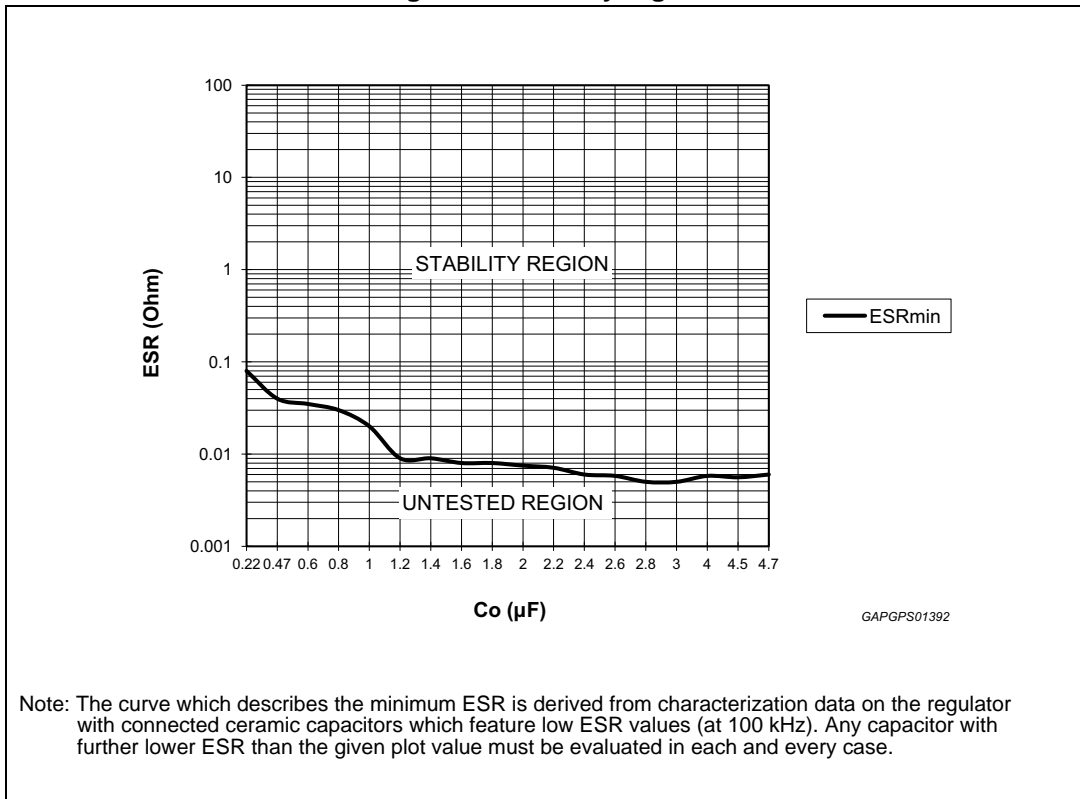
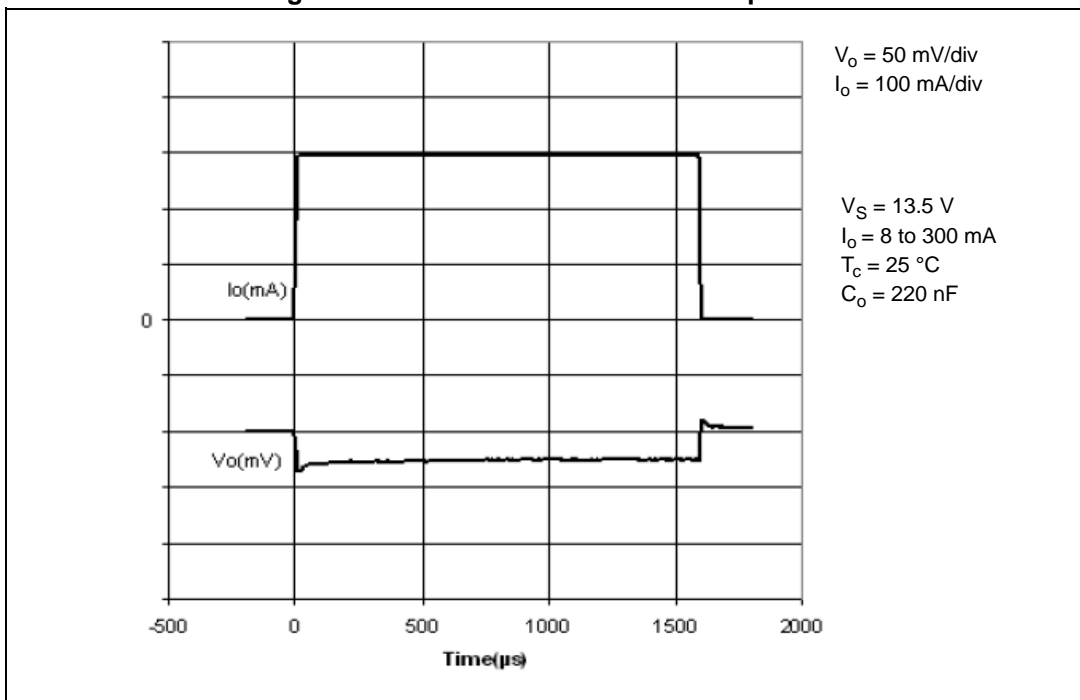

Figure 25. Maximum load variation response



3.2 Reset

The reset circuit monitors the output voltage V_o . If the output voltage becomes lower than V_{o_th} then R_{es} goes low with a delay time (t_{rr}). When the output voltage becomes higher than V_{o_th} then R_{es} goes high with a delay time T_{rd} . This delay is obtained by 32 periods of oscillator.

The oscillator period is given by:

Equation 1

$$T_{osc} = [(V_{Rhth} - V_{Rlth}) \times C_{tr}] / I_{cr} + [(V_{Rhth} - V_{Rlth}) \times C_{tr}] / I_{dr}$$

where:

- $I_{cr} = 20 \mu A$ is an internally generated charge current,
- $I_{dr} = 20 \mu A$ is an internally generated discharge current,
- $V_{Rhth} = 2.5 V$ (typ) and $V_{Rlth} = 0.95 V$ (typ) are two voltage thresholds,
- C_{tr} is an external capacitor to be put between V_{cr} pin and GND.

Reset pulse delay T_{rd} is given by:

Equation 2

$$T_{rd} = 32 \times T_{osc}$$

Figure 26. Reset time diagram

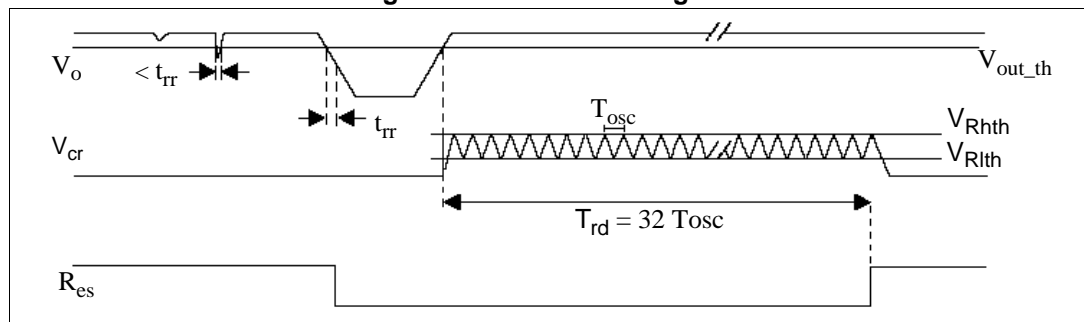

3.3 Early warning

This circuit compares the EW_i input signal with the internal voltage reference (typically 2.5 V). The use of an external voltage divider makes the comparator very flexible in the application. This function can be used to supervise the supply input voltage either before or after the protection diode and to give additional information to the microprocessor such as low voltage warnings.

Figure 27. Early warning time diagram

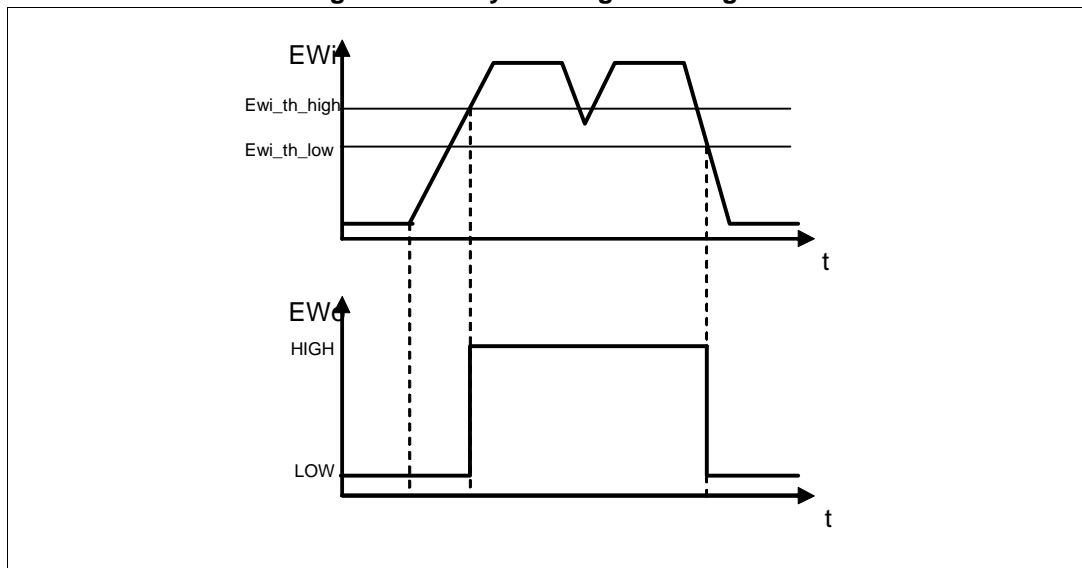

3.4 Enable

L5300GJ is also provided with an enable input, a high signal switches the regulator ON. In standby mode the output is disabled and the current consumption of the device (quiescent current) is less than 10 μA .

4 Package and PCB thermal data

Figure 28. PowerSSO-12 PC board⁽¹⁾

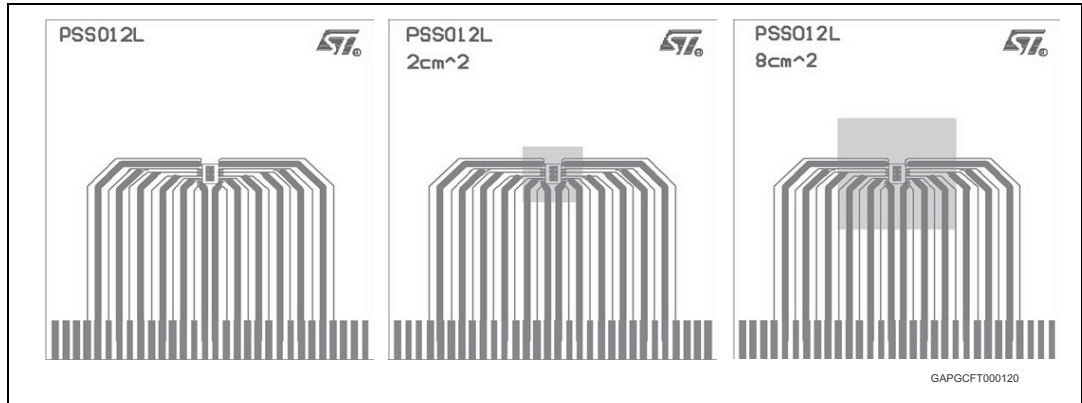

1. Layout condition of R_{th} and Z_{th} measurements (PCB: double layer, thermal vias, FR4 area = 77 mm x 86 mm, PCB thickness = 1.6 mm, Cu thickness = 70 μ m (front and back side), thermal vias separation 1.2 mm, thermal via diameter 0.3 mm +/- 0.08 mm, Cu thickness on vias 0.025 mm, Footprint dimension 4.1 mm x 6.5 mm).

Figure 29. $R_{thj-amb}$ Vs. PCB copper area in open box free air condition

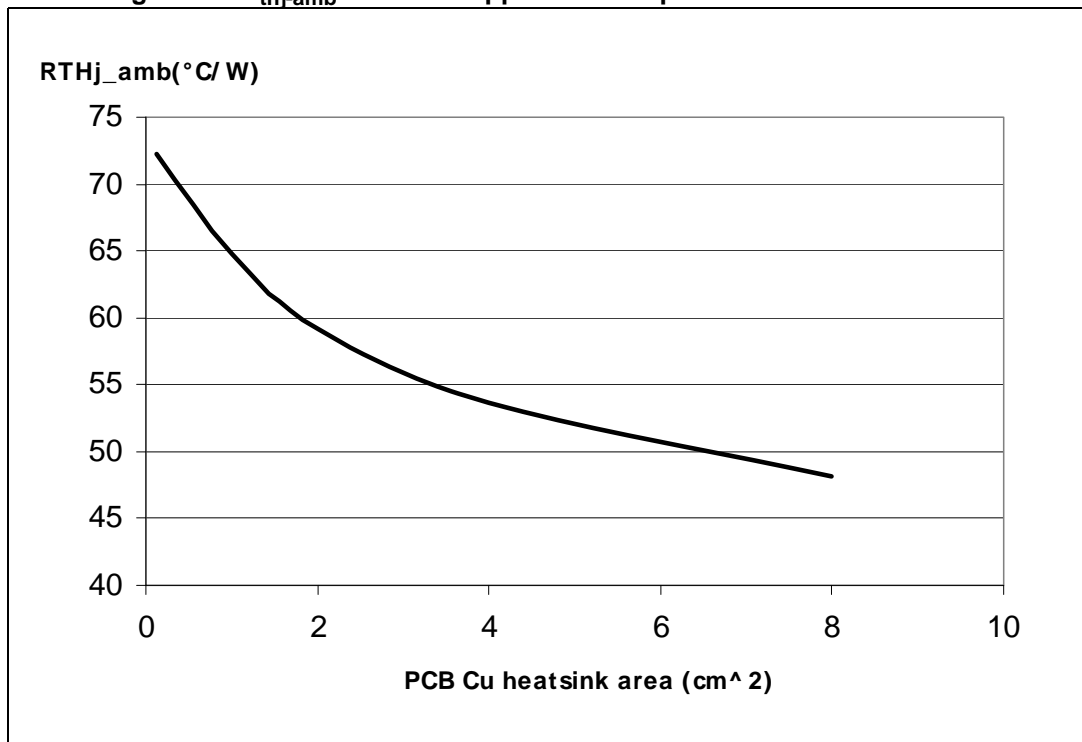
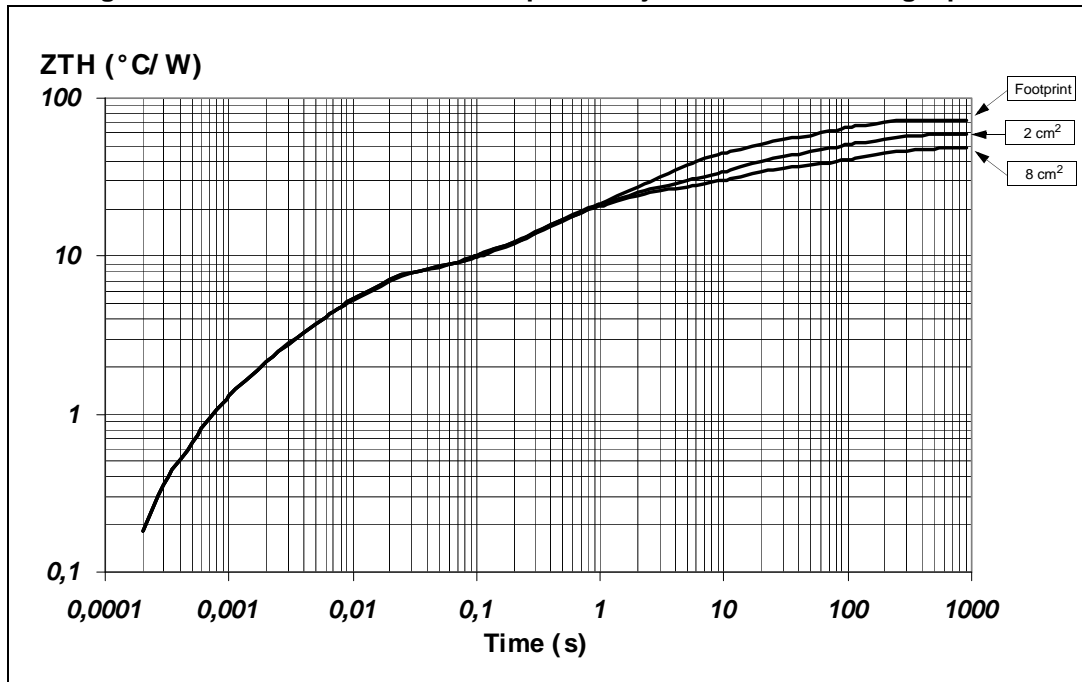

Figure 30. PowerSSO-12 thermal impedance junction ambient single pulse



Equation 3: pulse calculation formula

$$Z_{TH\delta} = R_{TH} \cdot \delta + Z_{THtp}(1 - \delta)$$

where $\delta = t_p/T$

Figure 31. Thermal fitting model of Vreg in in PowerSSO-12

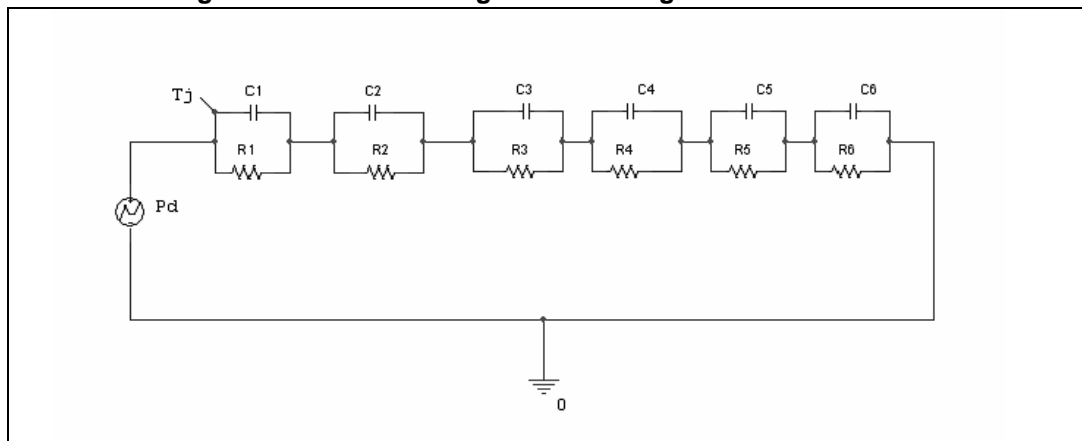

Table 9. PowerSSO-12 thermal parameter

| Area (cm ²) | Footprint | 2 | 8 |
|-------------------------|-----------|-----|-----|
| R1 (°C/W) | 1.2 | | |
| R2 (°C/W) | 6 | | |
| R3 (°C/W) | 7 | | |
| R4 (°C/W) | 10 | 10 | 9 |
| R5 (°C/W) | 22 | 15 | 10 |
| R6 (°C/W) | 26 | 20 | 15 |
| C1 (W.s/°C) | 0.0008 | | |
| C2 (W.s/°C) | 0.0016 | | |
| C3 (W.s/°C) | 0.05 | | |
| C4 (W.s/°C) | 0.2 | 0.1 | 0.1 |
| C5 (W.s/°C) | 0.27 | 0.8 | 1 |
| C6 (W.s/°C) | 3 | 6 | 9 |

5 Package and packing information

5.1 ECOPACK®

In order to meet environmental requirements, ST offers these devices in different grades of ECOPACK® packages, depending on their level of environmental compliance. ECOPACK® specifications, grade definitions and product status are available at: www.st.com. ECOPACK® is an ST trademark.

5.2 PowerSSO-12 mechanical data

Figure 32. PowerSSO-12 package dimensions

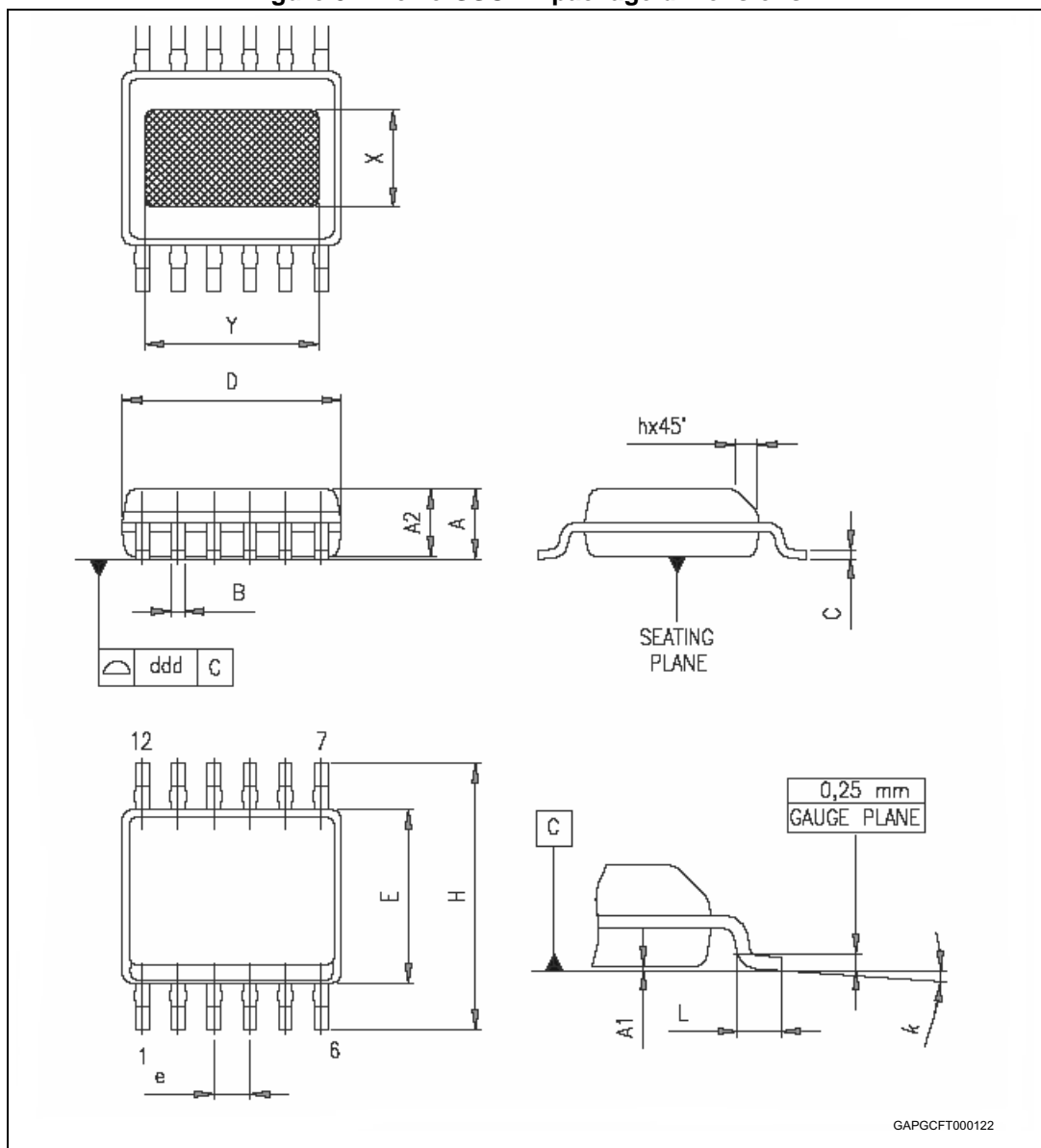

Table 10. PowerSSO-12 mechanical data

| Symbol | Millimeters | | |
|--------|-------------|-------|-------|
| | Min. | Typ. | Max. |
| A | 1.250 | | 1.620 |
| A1 | 0.000 | | 0.100 |
| A2 | 1.100 | | 1.650 |
| B | 0.230 | | 0.410 |
| C | 0.190 | | 0.250 |
| D | 4.800 | | 5.000 |
| E | 3.800 | | 4.000 |
| e | | 0.800 | |
| H | 5.800 | | 6.200 |
| h | 0.250 | | 0.500 |
| L | 0.400 | | 1.270 |
| k | 0° | | 8° |
| X | 2.200 | | 2.800 |
| Y | 2.900 | | 3.500 |
| ddd | | | 0.100 |

5.3 PowerSSO-12 packing information

Figure 33. PowerSSO-12 tube shipment (no suffix)

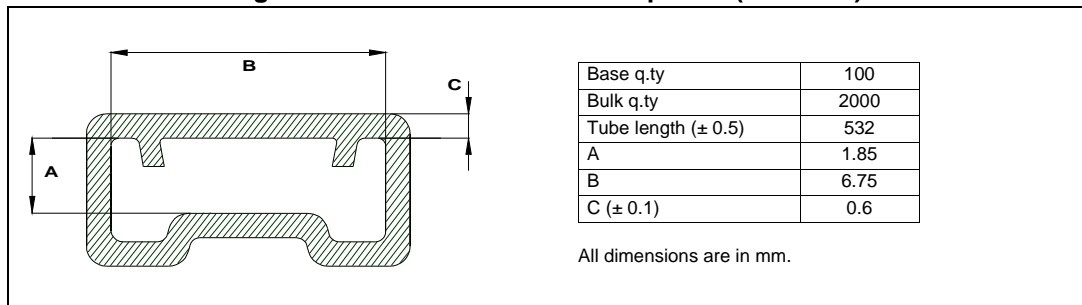
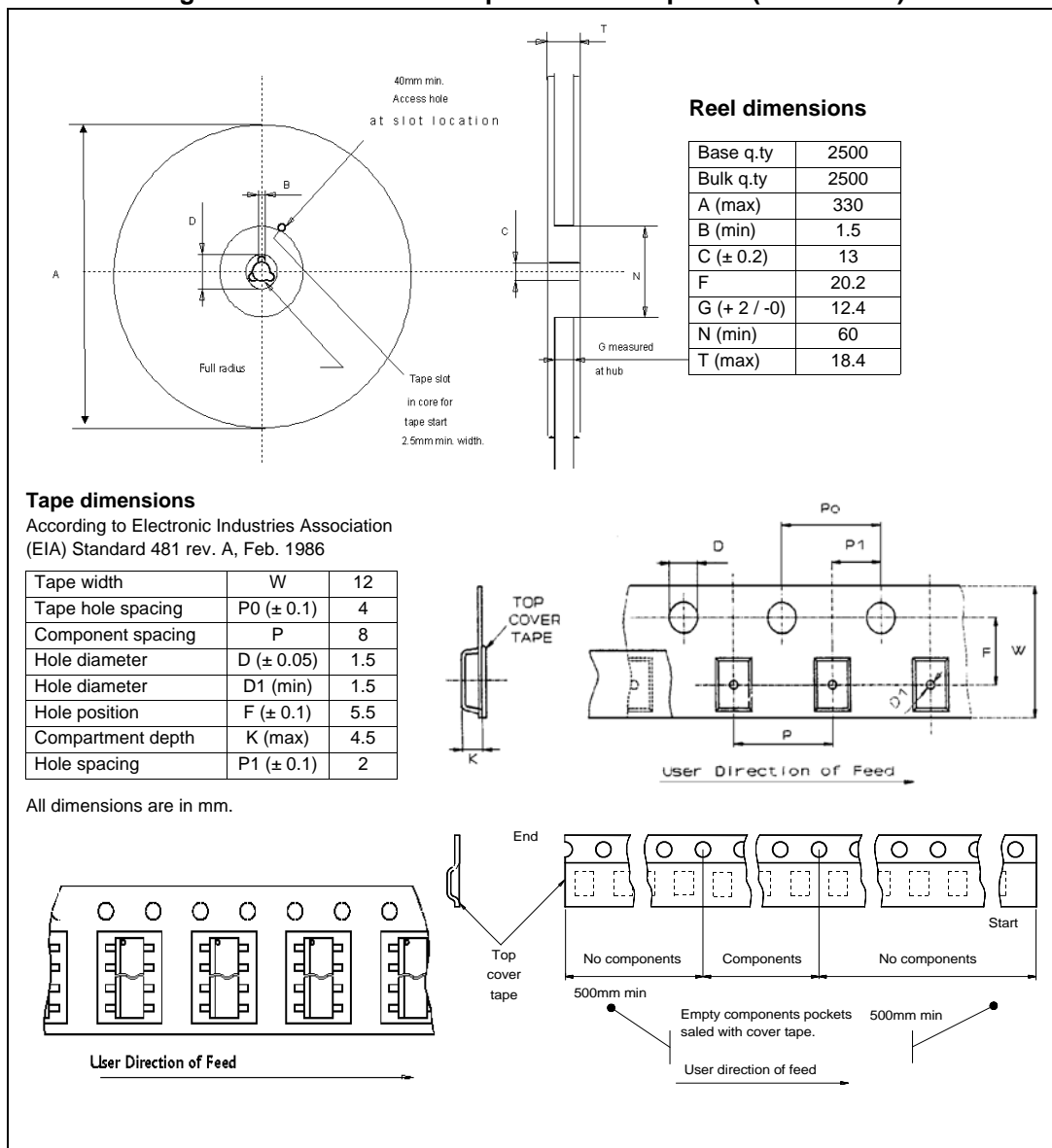

Figure 34. PowerSSO-12 tape and reel shipment (suffix “TR”)



6 Revision history

Table 11. Document revision history

| Date | Revision | Changes |
|-------------|----------|---|
| 09-Aug-2007 | 1 | Initial release. |
| 17-Sep-2008 | 2 | <p>Changed rev. numbering according with new "Target" standard. Updated quiescent currents on Features table. Updated Description on cover page. Changed Figure 1: Block diagram. Updated Figure 2: Configuration diagram (top view): – added pin names. Updated Table 2: Pins description: – changed pin 5 from NC to V_{os} Added values to Table 4: Thermal data. Updated Table 5.: General: – updated test condition on V_{o_ref} – changed I_{short} values – changed I_{lim} values – updated test condition on V_{line} – updated test condition on V_{load} – Inserted I_{oth_H} – Inserted I_{oth_L} – Inserted I_{oth_Hyst} Updated Table 6: Reset: – updated test condition on V_{res_l} – updated test condition on V_{o_th} – changed V_{Rlth} values – deleted test condition on T_{rr} – changed T_{rd} values Updated Table 7: Early warning: – updated test condition on E_{Wo_lv} – updated test condition on I_{Wo} Updated Table 8: Enable: – changed typ. value on V_{En_hyst} – updated test condition on I_{leak} Updated Chapter 3: Application information – deleted Figure 3: Behavior of output current versus regulated voltage V_o – updated Section 3.2: Reset – updated Section 3.4: Enable Added Chapter 4: Package and PCB thermal data. Updated Table 10: PowerSSO-12 mechanical data: – changed slug dimensions – $I_o = 1$ to 300 mA</p> |

Table 11. Document revision history (continued)

| Date | Revision | Changes |
|-------------|----------|---|
| 13-Mar-2009 | 3 | <p>Table 2: Pins description</p> <ul style="list-style-type: none"> – V_{OS}: changed function <p>Table 6: Reset</p> <ul style="list-style-type: none"> – I_{Res_Ikg}: deleted $V_{Res} = 5\text{ V}$ from Test condition – V_{O_th}: deleted $I_o = 1\text{ mA}$ to 300 mA from Test condition – V_{Rlth}: changed min/typ/max values – T_{rd}: changed min/typ/max values <p>Section 3.2: Reset</p> <ul style="list-style-type: none"> – V_{Rlth}: changed coefficient <p>Section 3.4: Enable</p> <ul style="list-style-type: none"> – Replaced $5\text{ }\mu\text{A}$ with $10\text{ }\mu\text{A}$ |
| 07-Dec-2009 | 4 | <p>Updated corporate template (from V2 to V3)</p> <p>Updated features list.</p> <p>Updated Figure 2: Configuration diagram (top view)</p> <p>Table 2: Pins description</p> <ul style="list-style-type: none"> – Added new row <p>Table 5: General</p> <ul style="list-style-type: none"> – I_{short}: changed min/typ/max value – I_{lim}: changed min/typ/max value – V_{line}: changed Test conditions – V_{load}: changed max value for $V_s = 8\text{ V}$ to 18 V, added new row <p>Table 6: Reset</p> <ul style="list-style-type: none"> – V_{Rlth}: changed min/typ value <p>Table 8: Enable</p> <ul style="list-style-type: none"> – I_{leak}: changed typ value <p>Section 3.3: Early warning</p> <ul style="list-style-type: none"> – changed typical internal voltage reference value (from 1.23 V to 2.5 V) <p>Added Section 2.4: Electrical characteristics curves.</p> <p>Updated Chapter 3.1: Voltage regulator.</p> |
| 27-Jan-2012 | 5 | Updated Figure 23: Application schematic and Figure 24: Stability region . |
| 07-Feb-2012 | 6 | Modified Figure 24: Stability region on page 15 . |
| 19-Sep-2013 | 7 | Updated disclaimer. |
| 26-Sep-2018 | 8 | Updated template. Updated Features and title. |