

Lx01Ex & LxNx & Qx01Ex & QxNx Series

RoHS

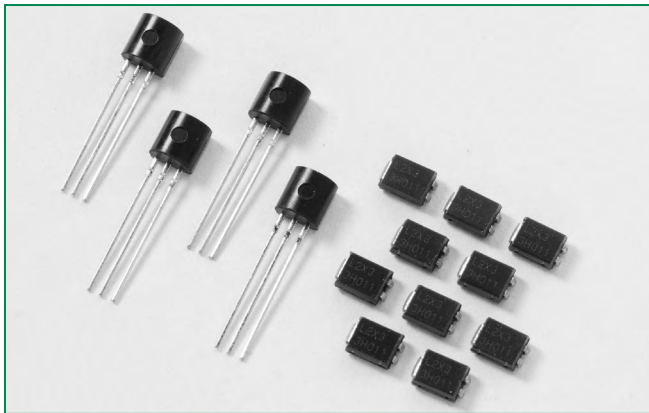

Description

1 Amp bi-directional solid state switch series is designed for AC switching and phase control applications such as motor speed and temperature modulation controls, lighting controls, and static switching relays.

Sensitive type devices guarantee gate control in Quadrants I & IV needed for digital control circuitry.

Standard type devices normally operate in Quadrants I & III triggered from AC line.

Features & Benefits

- RoHS Compliant
- Glass – passivated junctions
- Voltage capability up to 600 V
- Surge capability up to 20 A

Applications

Excellent for lower current heating controls, water valves, and solenoids.

Typical applications are AC solid-state switches, home/brown goods and white goods appliances.

Sensitive gate Triacs can be directly driven by microprocessor or popular opto-couplers/isolators.

Main Features

Symbol	Value	Unit
$I_{T(RMS)}$	1	A
V_{DRM}/V_{RRM}	400 to 600	V
$I_{GT(Q1)}$	3 to 25	mA

Schematic Symbol

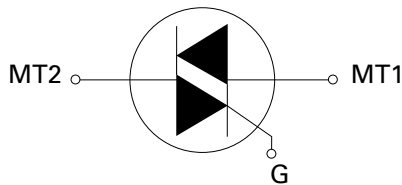

Additional Information



Datasheet



Resources



Samples

Absolute Maximum Ratings — Sensitive Triacs (4 Quadrants)

Symbol	Parameter	Value	Unit
$I_{T(RMS)}$	RMS on-state current (full sine wave)	Lx01Ey/LxNy $T_C = 50^\circ\text{C}$	1 A
I_{TSM}	Non repetitive surge peak on-state current (full cycle, T_J initial = 25°C)	$f = 50\text{ Hz}$ $t = 20\text{ ms}$	16.7 A
		$f = 60\text{ Hz}$ $t = 16.7\text{ ms}$	20 A
I^2t	I^2t Value for fusing	$t_p = 8.3\text{ ms}$	1.6 A^2s
di/dt	Critical rate of rise of on-state current ($I_G = 50\text{mA}$ with $\leq 0.1\mu\text{s}$ rise time)	$f = 120\text{ Hz}$ $T_J = 110^\circ\text{C}$	20 $\text{A}/\mu\text{s}$
I_{GTM}	Peak gate trigger current	$t_p \leq 10\text{ }\mu\text{s}$ $T_J = 110^\circ\text{C}$	1 A
$P_{G(AV)}$	Average gate power dissipation	$T_J = 110^\circ\text{C}$	0.2 W
T_{stg}	Storage temperature range	Lx01Ey	-65 to 150 $^\circ\text{C}$
		LxNy	-40 to 125 $^\circ\text{C}$
T_J	Operating junction temperature range	Lx01Ey	-65 to 110 $^\circ\text{C}$
		LxNy	-40 to 110 $^\circ\text{C}$

Note: x = voltage, y = sensitivity

Absolute Maximum Ratings — Standard Triacs

Symbol	Parameter			Value	Unit
$I_{T(RMS)}$	RMS on-state current (full sine wave)	Qx01Ey/QxNy	$T_C = 60^\circ\text{C}$	1	A
I_{TSM}	Non repetitive surge peak on-state current (full cycle, T_J initial = 25°C)	f = 50 Hz	t = 20 ms	16.7	A
		f = 60 Hz	t = 16.7 ms	20	
I^2t	I^2t Value for fusing	$t_p = 8.3$ ms		1.6	A ² s
di/dt	Critical rate of rise of on-state current ($I_G = 200\text{mA}$ with $\leq 0.1\mu\text{s}$ rise time)	f = 120 Hz	$T_J = 125^\circ\text{C}$	20	A/ μs
I_{GTM}	Peak gate trigger current	$t_p \leq 10 \mu\text{s};$ $I_{GT} \leq I_{GTM}$	$T_J = 125^\circ\text{C}$	1	A
$P_{G(AV)}$	Average gate power dissipation	$T_J = 125^\circ\text{C}$		0.2	W
T_{stg}	Storage temperature range	Qx01Ey		-65 to 150	$^\circ\text{C}$
		QxNy		-40 to 150	
T_J	Operating junction temperature range	Qx01Ey		-65 to 125	$^\circ\text{C}$
		QxNy		-40 to 125	

Note: x = voltage, y = sensitivity

Electrical Characteristics ($T_J = 25^\circ\text{C}$, unless otherwise specified) — Sensitive Triac (4 Quadrants)

Symbol	Test Conditions	Quadrant		Lx01E3 LxN3	Lx01E5 LxN5	Lx01E6 LxN6	Lx01E8 LxN8	Unit
		I – II – III	IV					
I_{GT}	$V_D = 12\text{V}$ $R_L = 60 \Omega$	I – II – III	MAX.	3	5	5	10	mA
		IV		3	5	10	20	
V_{GT}	$V_D = 12\text{V}$ $R_L = 60 \Omega$	ALL	MAX.	1.3				V
V_{GD}	$V_D = V_{DRM}$ $R_L = 3.3 \text{k}\Omega$ $T_J = 110^\circ\text{C}$	ALL	MIN.	0.2				V
I_H	$I_T = 100\text{mA}$		MAX.	5	10	10	15	mA
dv/dt	$V_D = V_{DRM}$ Gate Open $T_J = 100^\circ\text{C}$	400V	TYP.	20	20	30	35	V/ μs
		600V		10	10	20	25	
(dv/dt)c	(di/dt)c = 0.54 A/ms $T_J = 110^\circ\text{C}$		TYP.	0.5	1	1	1	V/ μs
t_{gt}	$I_G = 2 \times I_{GT}$ PW = 15 μs $I_T = 1.41$ A(pk)		TYP.	2.8	3.0	3.0	3.2	μs

Electrical Characteristics ($T_J = 25^\circ\text{C}$, unless otherwise specified) — Standard Triac

Symbol	Test Conditions	Quadrant		Qx01E3 QxN3	Qx01E4 QxN4	Unit
		I – II – III	IV			
I_{GT}	$V_D = 12\text{V}$ $R_L = 60 \Omega$	I – II – III	MAX.	10	25	mA
		IV	TYP.	25	50	
V_{GT}	$V_D = 12\text{V}$ $R_L = 60 \Omega$	I – II – III	MAX.	1.3	1.3	V
V_{GD}	$V_D = V_{DRM}$ $R_L = 3.3 \text{k}\Omega$ $T_J = 125^\circ\text{C}$	ALL	MIN.	0.2	0.2	V
I_H	$I_T = 200\text{mA}$		MAX.	15	25	mA
dv/dt	$V_D = V_{DRM}$ Gate Open $T_J = 125^\circ\text{C}$	400V	MIN.	30	40	V/ μs
		600V		20	30	
(dv/dt)c	(di/dt)c = 0.54 A/ms $T_J = 125^\circ\text{C}$		TYP.	1	1	V/ μs
t_{gt}	$I_G = 2 \times I_{GT}$ PW = 15 μs $I_T = 1.41$ A(pk)		TYP.	2.5	3.0	μs

Note: x = voltage, y = sensitivity

Static Characteristics ($T_J = 25^\circ\text{C}$, unless otherwise specified)

Symbol	Test Conditions	Value	Unit	
V_{TM}	$I_{TM} = 1.41\text{A}$ $t_p = 380\ \mu\text{s}$	MAX.	1.60 V	
I_{DRM} I_{RRM}	$V_{DRM} = V_{RRM}$	MAX.	Lx01Ey / LxNy	
			$T_J = 25^\circ\text{C}$ 400-600V	2 μA
			$T_J = 110^\circ\text{C}$ 400-600V	0.1 mA
			Qx01Ey / QxNy	
$T_J = 25^\circ\text{C}$ 400-600V	5 μA			
$T_J = 125^\circ\text{C}$ 400-600V	1 mA			

Thermal Resistances

Symbol	Parameter	Value	Unit
$R_{\theta(J-C)}$	Junction to case (AC)	L/Qx01Ey	50
		L/QxNy	40*
$R_{\theta(J-A)}$	Junction to ambient	L/Qx01Ey	95

Note: * = Mounted on 1 cm² copper (two-ounce) foil surface

Figure 1: Definition of Quadrants

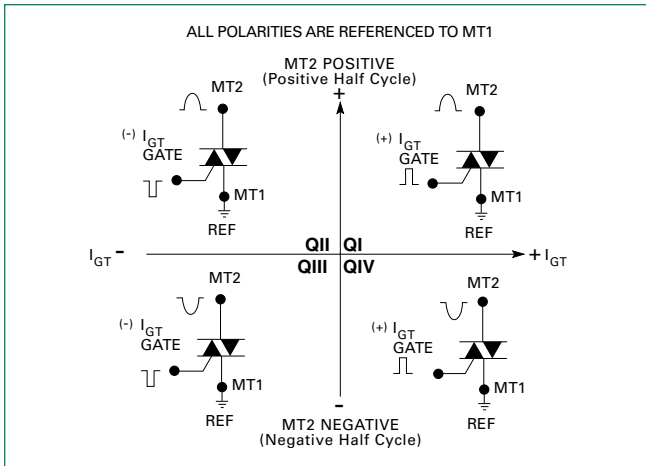

Figure 2: Normalized DC Gate Trigger Current for All Quadrants vs. Junction Temperature

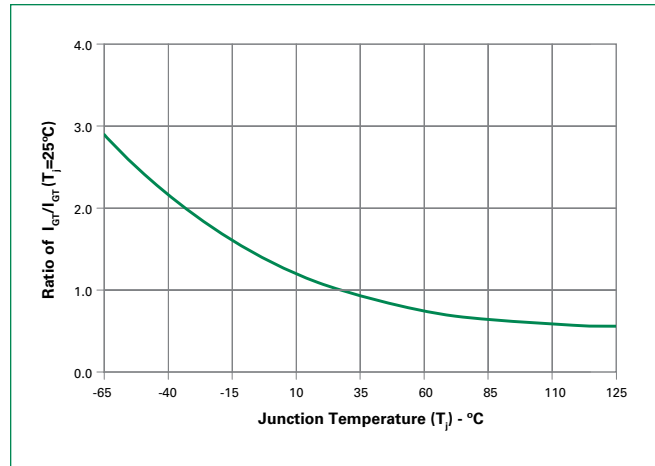

Figure 3: Normalized DC Holding Current vs. Junction Temperature

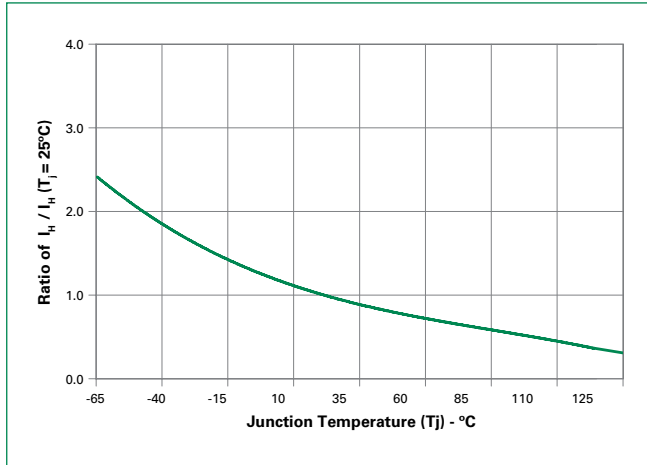

Figure 4: Normalized DC Gate Trigger Voltage for All Quadrants vs. Junction Temperature

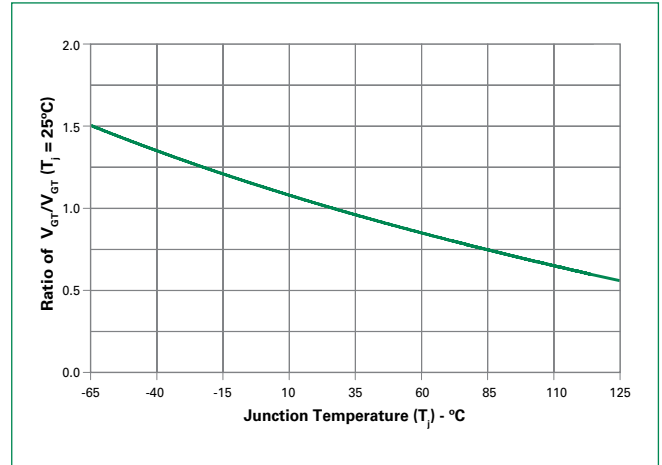

Figure 5: Power Dissipation (Typical) vs. RMS On-State Current

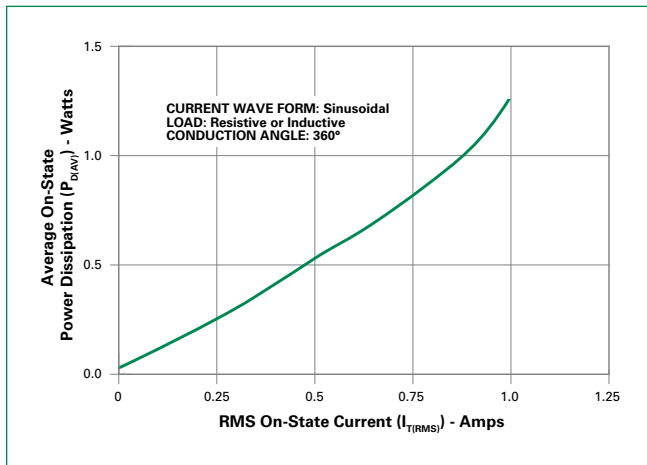

Figure 6: Maximum Allowable Case Temperature vs. On-State Current

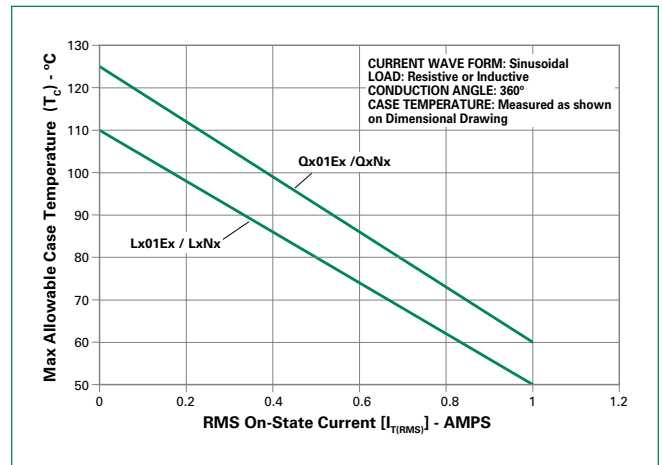

Figure 7: Maximum Allowable Ambient Temperature vs. On-State Current

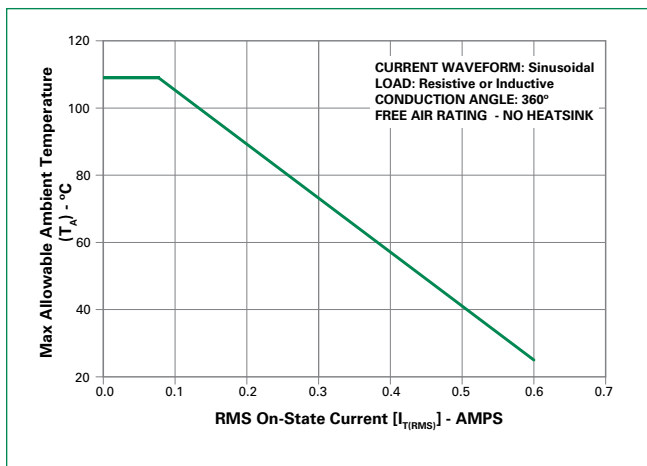

Figure 8: On-State Current vs. On-State Voltage (Typical)

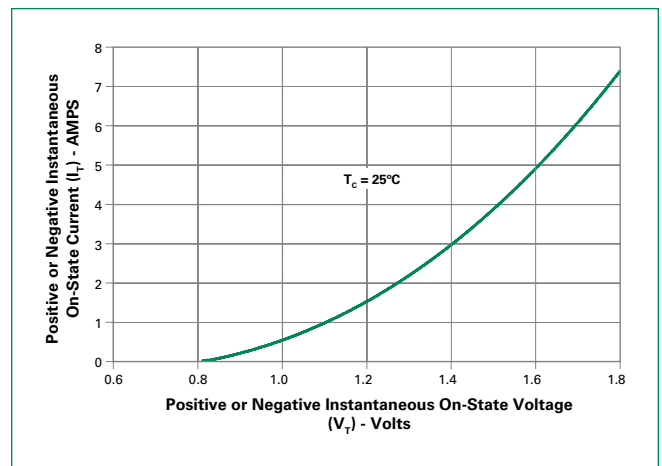
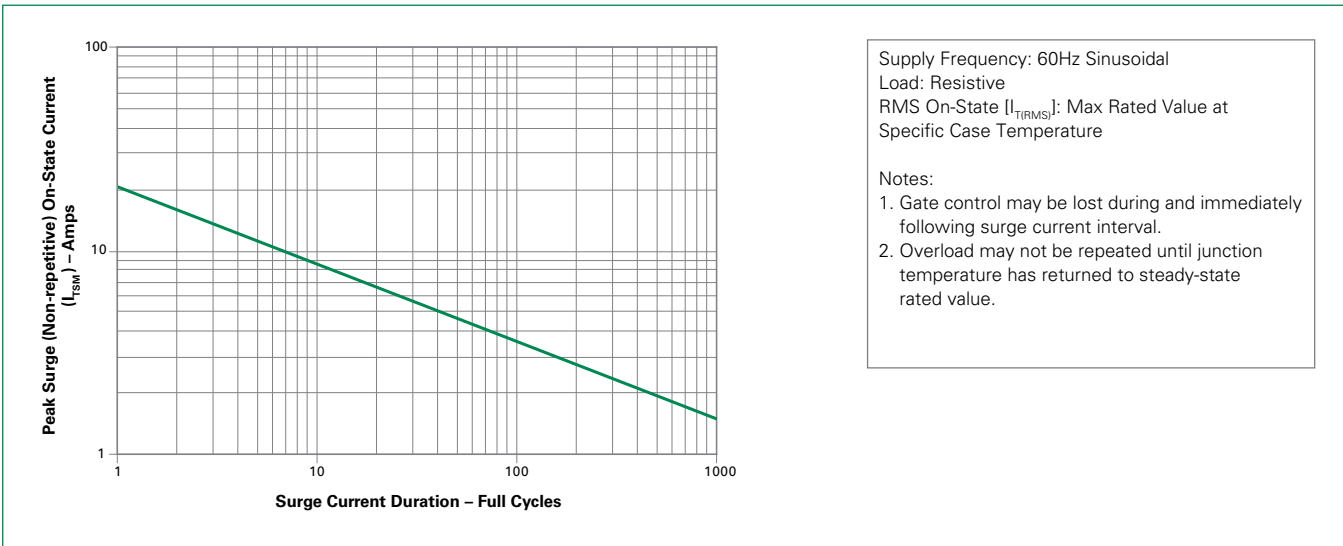
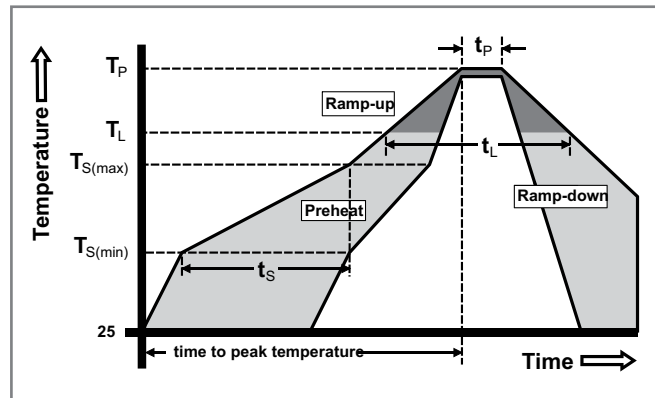

Figure 9: Surge Peak On-State Current vs. Number of Cycles



Soldering Parameters

Reflow Condition		Pb – Free assembly
Pre Heat	- Temperature Min ($T_{s(min)}$)	150°C
	- Temperature Max ($T_{s(max)}$)	200°C
	- Time (min to max) (t_s)	60 – 180 secs
Average ramp up rate (Liquidus Temp) (T_L) to peak		5°C/second max
$T_{s(max)}$ to T_L - Ramp-up Rate		5°C/second max
Reflow	- Temperature (T_L) (Liquidus)	217°C
	- Temperature (t_L)	60 – 150 seconds
Peak Temperature (T_p)		260 ^{+0/-5} °C
Time within 5°C of actual peak Temperature (t_p)		20 – 40 seconds
Ramp-down Rate		5°C/second max
Time 25°C to peak Temperature (T_p)		8 minutes Max.
Do not exceed		280°C



Physical Specifications

Terminal Finish	100% Matte Tin-plated
Body Material	UL recognized epoxy meeting flammability classification 94V-0
Terminal Material	Copper Alloy

Design Considerations

Careful selection of the correct device for the application's operating parameters and environment will go a long way toward extending the operating life of the Thyristor. Good design practice should limit the maximum continuous current through the main terminals to 75% of the device rating. Other ways to ensure long life for a power discrete semiconductor are proper heat sinking and selection of voltage ratings for worst case conditions. Overheating, overvoltage (including dv/dt), and surge currents are the main killers of semiconductors. Correct mounting, soldering, and forming of the leads also help protect against component damage.

Environmental Specifications

Test	Specifications and Conditions
AC Blocking	MIL-STD-750, M-1040, Cond A Applied Peak AC voltage @ 125°C for 1008 hours
Temperature Cycling	MIL-STD-750, M-1051, 100 cycles; -40°C to +150°C; 15-min dwell time
Temperature/Humidity	EIA / JEDEC, JESD22-A101 1008 hours; 320V - DC: 85°C; 85% rel humidity
High Temp Storage	MIL-STD-750, M-1031, 1008 hours; 150°C
Low-Temp Storage	1008 hours; -40°C
Resistance to Solder Heat	MIL-STD-750 Method 2031
Solderability	ANSI/J-STD-002, category 3, Test A
Lead Bend	MIL-STD-750, M-2036 Cond E

Dimensions - Compak (C Package)

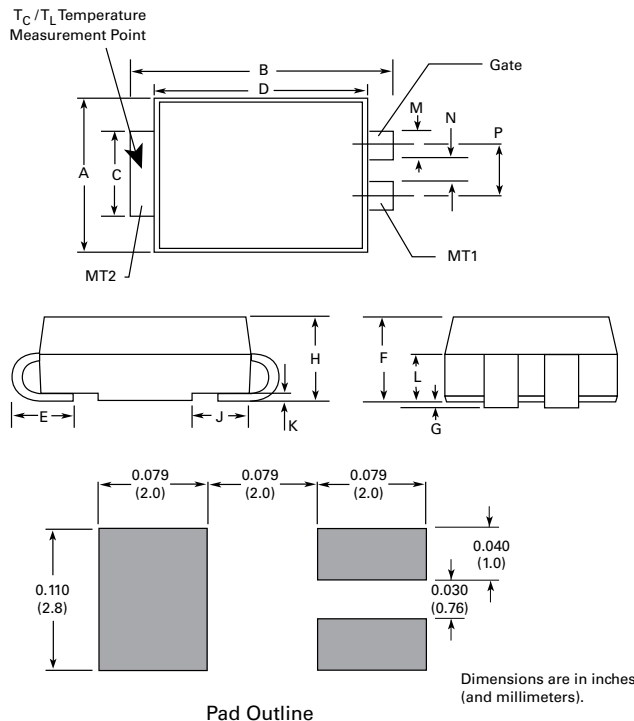

Dimension	Inches		Millimeters	
	Min	Max	Min	Max
A	0.130	0.156	3.30	3.95
B	0.201	0.220	5.10	5.60
C	0.077	0.087	1.95	2.20
D	0.159	0.181	4.05	4.60
E	0.030	0.063	0.75	1.60
F	0.075	0.096	1.90	2.45
G	0.002	0.008	0.05	0.20
H	0.077	0.104	1.95	2.65
J	0.043	0.053	1.09	1.35
K	0.006	0.016	0.15	0.41
L	0.030	0.055	0.76	1.40
M	0.022	0.028	0.56	0.71
N	0.027	0.033	0.69	0.84
P	0.052	0.058	1.32	1.47

Dimensions - TO-92 (E Package)

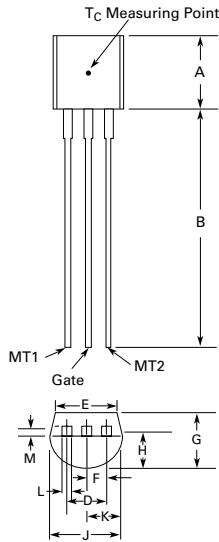

Dimension	Inches		Millimeters	
	Min	Max	Min	Max
A	0.176	0.196	4.47	4.98
B	0.500	-	12.70	-
D	0.095	0.105	2.41	2.67
E	0.150	-	3.81	-
F	0.046	0.054	1.16	1.37
G	0.135	0.145	3.43	3.68
H	0.088	0.096	2.23	2.44
J	0.176	0.186	4.47	4.73
K	0.088	0.096	2.23	2.44
L	0.013	0.019	0.33	0.48
M	0.013	0.017	0.33	0.43

All leads insulated from case. Case is electrically nonconductive.

Product Selector

Part Number	Voltage		Gate Sensitivity Quadrants		Type	Package
	400V	600V	I – II – III	IV		
Lx01E3	X	X	3 mA	3 mA	Sensitive Triac	TO-92
LxN3	X	X	3 mA	3 mA	Sensitive Triac	Compak
Lx01E5	X	X	5 mA	5 mA	Sensitive Triac	TO-92
LxN5	X	X	5 mA	5 mA	Sensitive Triac	Compak
Lx01E6	X	X	5 mA	10 mA	Sensitive Triac	TO-92
Lx01E8	X	X	10 mA	20 mA	Sensitive Triac	TO-92
Qx01E3	X	X	10 mA		Standard Triac	TO-92
QxN3	X	X	10 mA		Standard Triac	Compak
Qx01E4	X	X	25 mA		Standard Triac	TO-92
QxN4	X	X	25 mA		Standard Triac	Compak

Note: x- voltage

Packing Options

Part Number	Marking	Weight	Packing Mode	Base Quantity
L/Qx01Ey	L/Qx01Ey	0.188 g	Bulk	2000
L/Qx01EyRP	L/Qx01Ey	0.188 g	Reel Pack	2000
L/Qx01EyAP	L/Qx01Ey	0.188 g	Ammo Pack	2000
L/QxNyRP	L/QxNy	0.081 g	Embossed Carrier	2500

Note: x = Voltage; y = Sensitivity

TO-92 (3-lead) Reel Pack (RP) Radial Ledged

Meets all EIA-468-C Standards

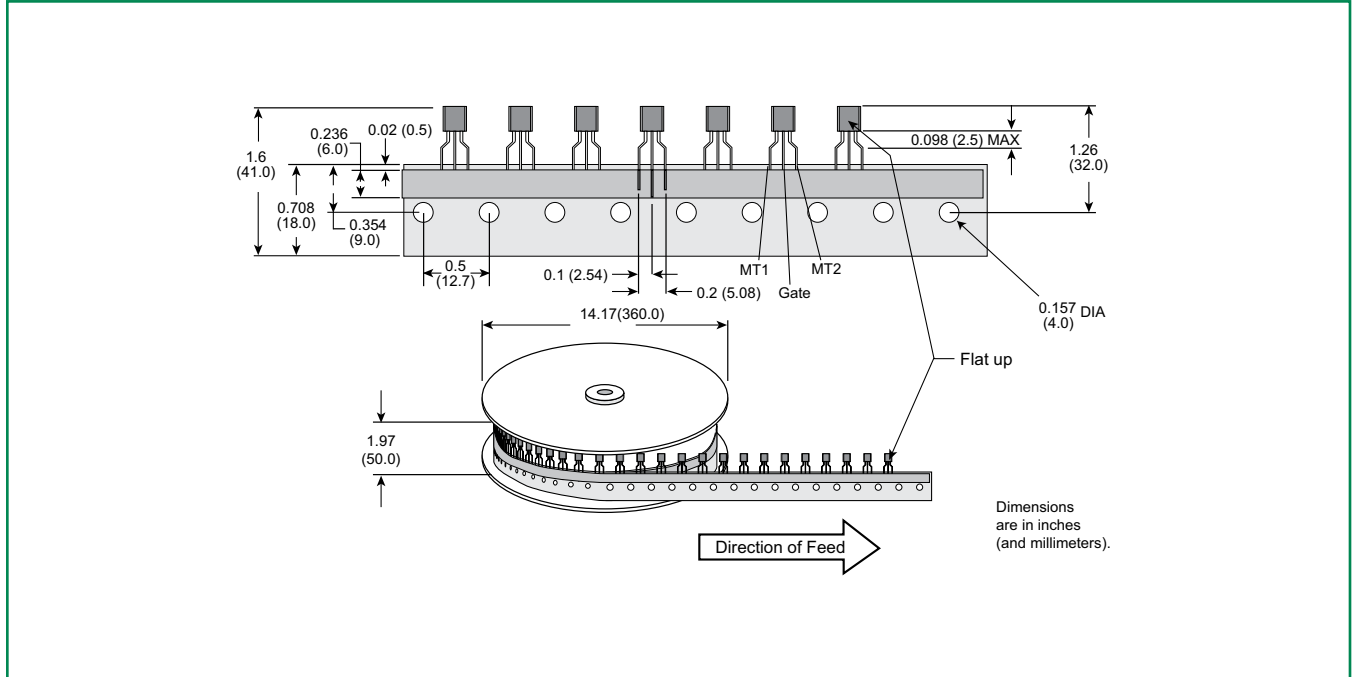

TO-92 (3-lead) Ammo Pack (AP) Radial Ledged

Meets all EIA-468-C Standards

