

# HATCH LED DRIVERS

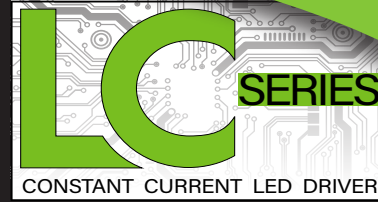

## GENERAL INFORMATION

LED Driver Type	Constant Current (Class 2)
Maximum Wattage	50 Watts
Input Voltage	120 - 277 VAC $\pm$ 10% Universal
Input Frequency	50/60Hz
Total Harmonic Distortion	<20%

## CASE STYLE T: POLYCARBONATE



## ELECTRICAL SPECIFICATIONS

Watts	Rated Current	Output Voltage	Dimming Type	Input Voltage	Input Power	Input Current	Power Factor	Efficiency	Hatch Part Number
<b>Dimming Models</b>									
50W	† **530mA	47-97 VDC	0-10V Dimming	120 - 277 VAC	60W	0.55/0.25A	>0.90	86%	LC50-0530Z-UNV-T
	† **700mA	36-71 VDC	0-10V Dimming	120 - 277 VAC	60W	0.55/0.25A	>0.90	86%	LC50-0700Z-UNV-T
	† **830mA	30-60 VDC	0-10V Dimming	120 - 277 VAC	60W	0.55/0.25A	>0.90	86%	LC50-0830Z-UNV-T
	† *1050mA	24-48 VDC	0-10V Dimming	120 - 277 VAC	60W	0.55/0.25A	>0.90	86%	LC50-1050Z-UNV-T
	† 1400mA	17-35 VDC	0-10V Dimming	120 - 277 VAC	60W	0.55/0.25A	>0.90	86%	LC50-1400Z-UNV-T
	† 1750mA	14-28 VDC	0-10V Dimming	120 - 277 VAC	60W	0.55/0.25A	>0.90	86%	LC50-1750Z-UNV-T
	† 2100mA	12-24 VDC	0-10V Dimming	120 - 277 VAC	60W	0.55/0.25A	>0.90	86%	LC50-2100Z-UNV-T
<b>Dual-Dimming Models</b>									
50W	† *1050mA	24-48 VDC	Dual Dimming	120 - 277 VAC	60W	0.52/0.24A	>0.90	85%	LC50-1050D-UNV-T
	† 1200mA	21-42 VDC	Dual Dimming	120 - 277 VAC	60W	0.52/0.24A	>0.90	85%	LC50-1200D-UNV-T
	† 1400mA	18-36 VDC	Dual Dimming	120 - 277 VAC	60W	0.52/0.24A	>0.90	85%	LC50-1400D-UNV-T
	† 2100mA	12-24 VDC	Dual Dimming	120 - 277 VAC	60W	0.52/0.24A	>0.90	85%	LC50-2100D-UNV-T
<b>Non-Dimming Models</b>									
50W	**700mA	36-72 VDC	Non-Dimming	120 - 277 VAC	57W	0.50/0.23A	>0.90	87%	LC50-0700N-UNV-T
	*1050mA	24-48 VDC	Non-Dimming	120 - 277 VAC	57W	0.50/0.23A	>0.90	87%	LC50-1050N-UNV-T
	2100mA	12-24 VDC	Non-Dimming	120 - 277 VAC	57W	0.50/0.23A	>0.90	87%	LC50-2100N-UNV-T

† CLASS P

\*\*Non-Class 2

\*Class 2 US Only

## PRODUCT FEATURES

- Short circuit and overload protection
- Over temperature protection on dual dimming models
- Suitable for dry and damp locations
- Withstanding voltage: I/P – O/P 2kVAC
- Surge Rating: 2kV L-N
- Operating temperature range: -40°C to 90°C (measured at Tcase)
- MTBF: 235,000 hours at 40°C ambient (~70°C Case Temperature)
- Inrush Current: <20A Max @230VAC, cold start 25°C
- 0-10V dimming & non-dimming models are a two stage design
- Dual dimming: 0-10V (10%) and reverse phase only
- Output Current tolerance +/- 5% @ 25°C
- 0-10V dimming range: 10%-100%

## APPROVALS

- UL 8750 recognized component
- UL Listed Class P (Dimming models)
- EN61000-3-2
- EMC: Meets FCC47 CFR Part 15 (Class B) consumer limits @ 120V
- EMC: Meets FCC47 CFR Part 15 (Class A) non-consumer limits @ 277V
- IP 66
- CE on Dual dim models only



Specifications subject to change with out notice.

### MECHANICAL SPECIFICATIONS: CASE STYLE T

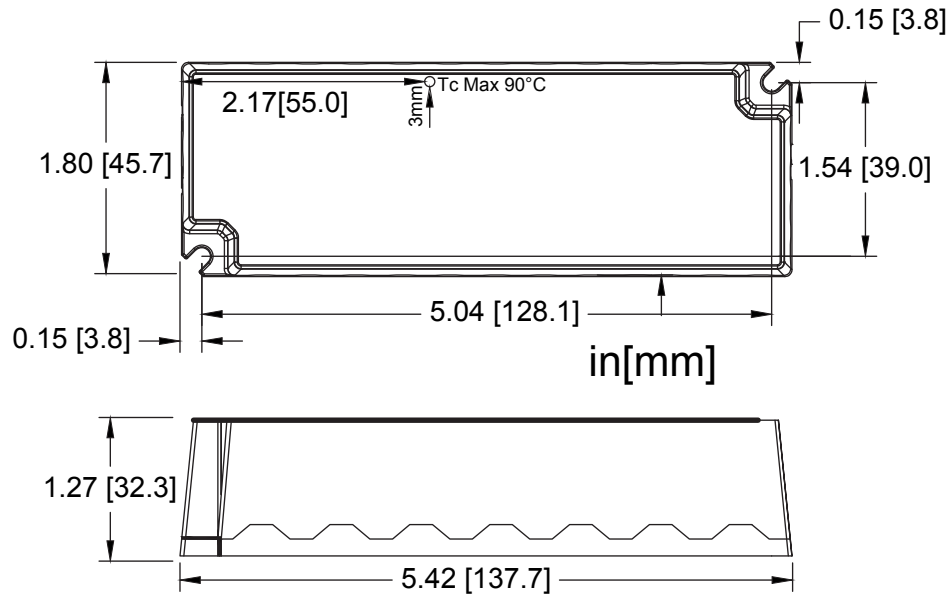

### DIMENSIONS [IN/MM]

Length:	5.42 [137.7]
Mounting:	5.04 [128.1]
Width:	1.80 [45.7]
Height:	1.27 [32.3]

### WIRING INFORMATION

Input:	12", Black (L), White (N) #18AWG
Output:	12", Red (+), Blue (-) #22AWG
Dimming:	12", Purple (+), Grey (-) # 22AWG

### WARRANTY

- 5 year limited warranty

### PACKAGING INFORMATION

Weight:	11 oz
Quantity:	40pc/carton

### PERFORMANCE CURVES

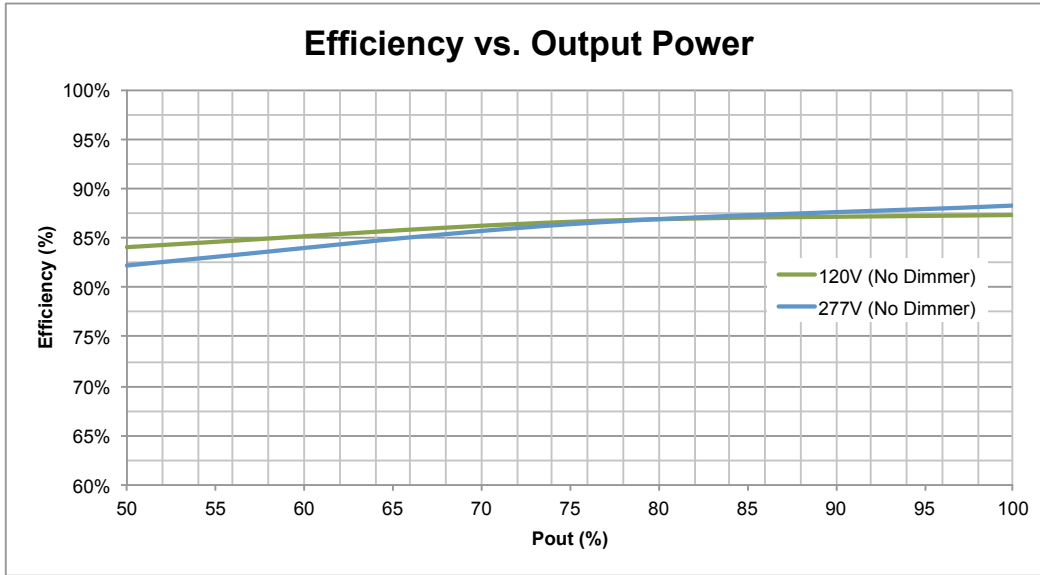

Measurements made on model LC50-1050Z-UNV-T.

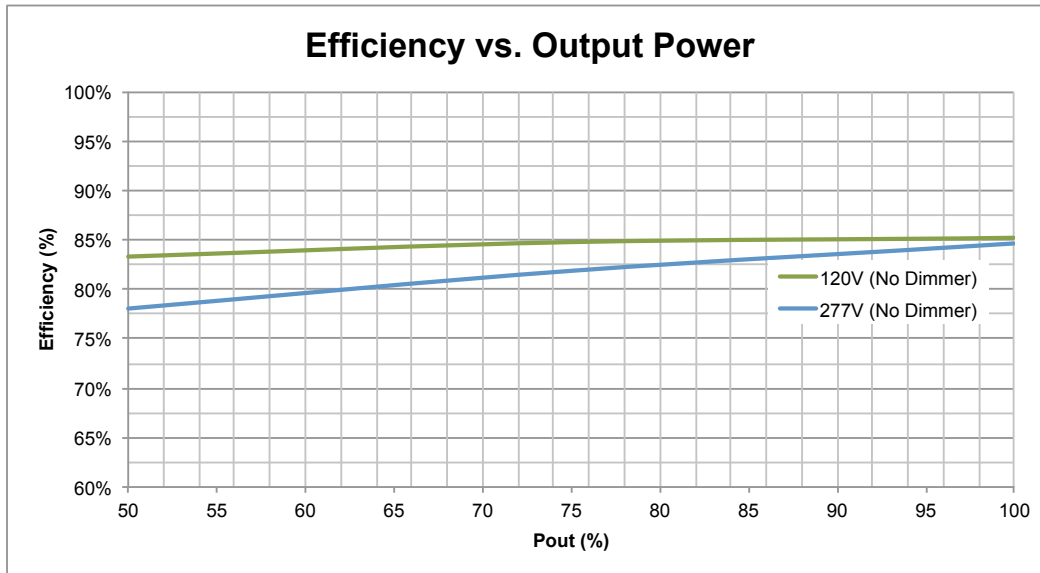

Measurements made on model LC50-1200D-UNV-T.  
Efficiency and PF measured at 25°C.

### PERFORMANCE CURVES

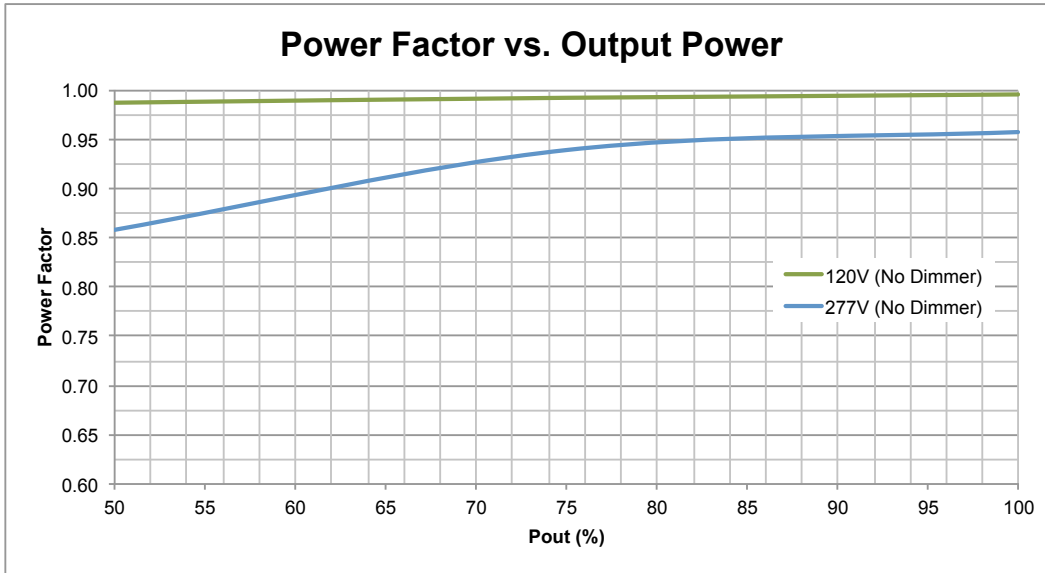

Measurements made on model LC50-1050Z-UNV-T.

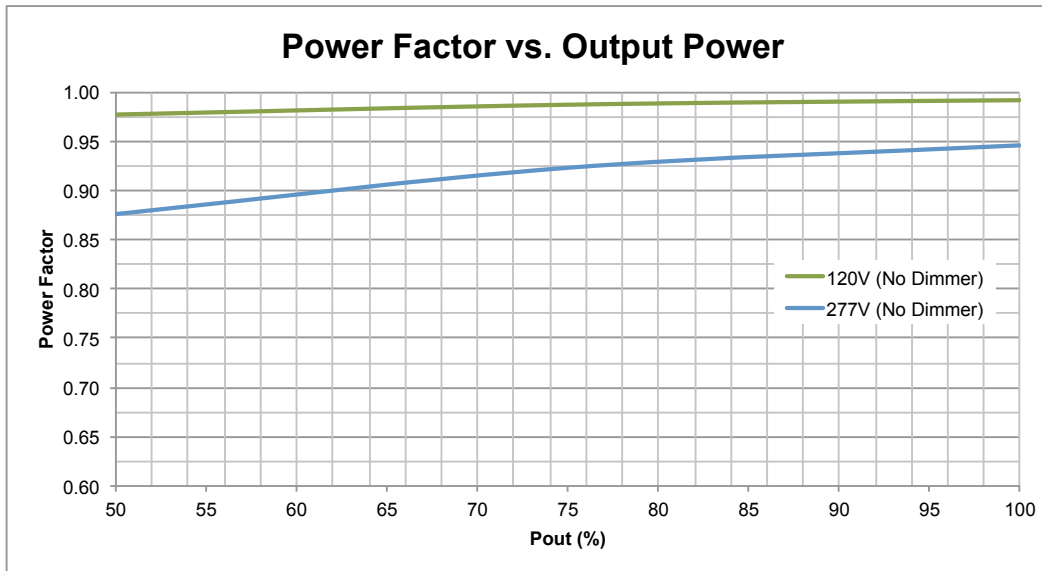

Measurements made on model LC50-1200D-UNV-T.  
Efficiency and PF measured at 25°C.

### PERFORMANCE CURVES

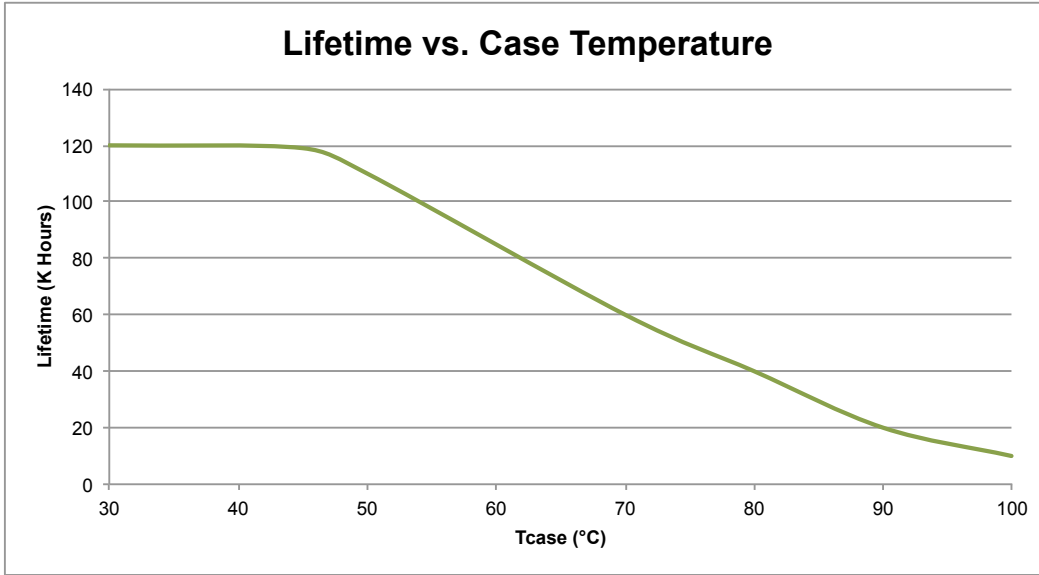

Measurements made on model LC50-1050Z-UNV-T.

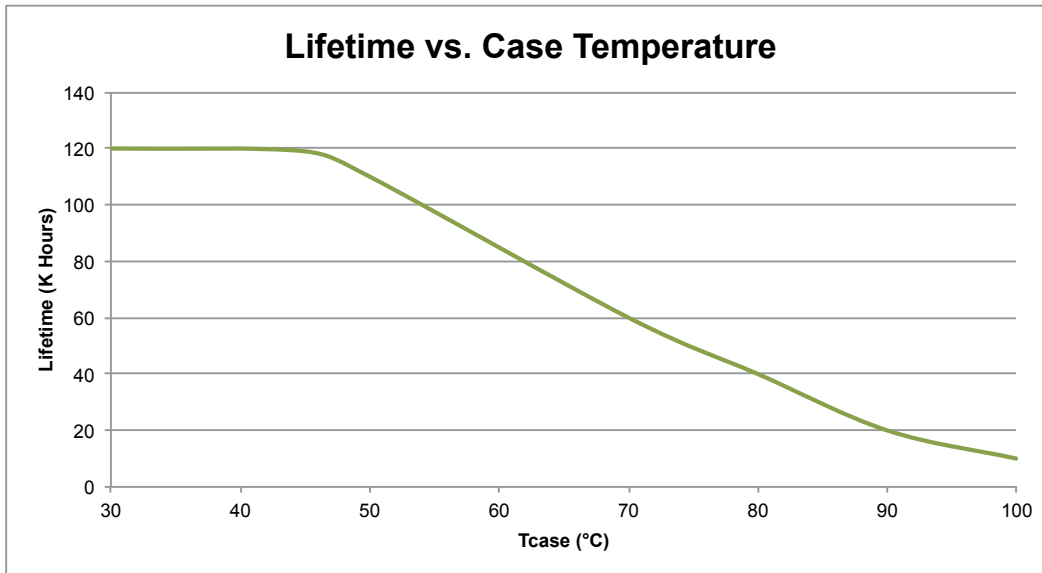

Measurements made on model LC50-1200D-UNV-T.  
Efficiency and PF measured at 25°C.