

# Notice for TAIYO YUDEN Products

Please read this notice before using the TAIYO YUDEN products.

## ⚠ REMINDERS

### Product Information in this Catalog

Product information in this catalog is as of March 2023. All of the contents specified herein and production status of the products listed in this catalog are subject to change without notice due to technical improvement of our products, etc. Therefore, please check for the latest information carefully before practical application or use of our products.

Please note that TAIYO YUDEN shall not be in any way responsible for any damages and defects in products or equipment incorporating our products, which are caused under the conditions other than those specified in this catalog or individual product specification sheets.

### Approval of Product Specifications

Please contact TAIYO YUDEN for further details of product specifications as the individual product specification sheets are available. When using our products, please be sure to approve our product specifications or make a written agreement on the product specification with TAIYO YUDEN in advance.

### Pre-Evaluation in the Actual Equipment and Conditions

Please conduct validation and verification of our products in actual conditions of mounting and operating environment before using our products.

### Limited Application

#### 1. Equipment Intended for Use

The products listed in this catalog are intended for general-purpose and standard use in general electronic equipment for consumer (e.g., AV equipment, OA equipment, home electric appliances, office equipment, information and communication equipment including, without limitation, mobile phone, and PC) and other equipment specified in this catalog or the individual product specification sheets, or the equipment approved separately by TAIYO YUDEN.

TAIYO YUDEN has the product series intended for use in the following equipment. Therefore, when using our products for these equipment, please check available applications specified in this catalog or the individual product specification sheets and use the corresponding products.

Application	Product Series		Quality Grade <sup>*3</sup>
	Equipment <sup>*1</sup>	Category (Part Number Code <sup>*2</sup> )	
Automotive	Automotive Electronic Equipment (POWERTRAIN, SAFETY)	A	1
	Automotive Electronic Equipment (BODY & CHASSIS, INFOTAINMENT)	C	2
Industrial	Telecommunications Infrastructure and Industrial Equipment	B	2
Medical	Medical Devices classified as GHTF Class C (Japan Class III)	M	2
	Medical Devices classified as GHTF Classes A or B (Japan Classes I or II)	L	3
Consumer	General Electronic Equipment	S	3
	Only for Mobile Devices <sup>*4</sup>	E	4

\*Notes: 1. Based on the general specifications required for electronic components for such equipment, which are recognized by TAIYO YUDEN, the use of each product series for the equipment is recommended. Please be sure to contact TAIYO YUDEN before using our products for equipment other than those covered by the product series.

2. On each of our part number, the 2nd code from the left is a code indicating the "Category" as shown in the above table. For details, please check the explanatory materials regarding the part numbering system of each of our products.

3. Each product series is assigned a "Quality Grade" from 1 to 4 in order of higher quality. Please do not incorporate a product into any equipment with a higher Quality Grade than the Quality Grade of such product without the prior written consent of TAIYO YUDEN.

4. The applications covered by this product series are limited to mobile devices (smartphone, tablet PC, smartwatch, handheld game console, etc.) among general electronic equipment for consumer. The design, specifications and operating environment, etc. differ from those of the product series for "General Electronic Equipment" (Category: S), so please check the individual product specification sheets for details. The product series for "General Electronic Equipment" (Category: S) can also be used for mobile devices.

▶ This catalog contains the typical specification only due to the limitation of space. When you consider the purchase of our products, please check our product specification sheets. For details of each product (characteristics graph, reliability information, precautions for use, and so on), see our website (<http://www.ty-top.com/>).

## 2. Equipment Requiring Inquiry

Please be sure to contact TAIYO YUDEN for further information before using the products listed in this catalog for the following equipment (excluding intended equipment as specified in this catalog or the individual product specification sheets) which may cause loss of human life, bodily injury, serious property damage and/or serious public impact due to a failure or defect of the products and/or malfunction attributed thereto.

- (1) Transportation equipment (automotive powertrain control system, train control system, and ship control system, etc.)
- (2) Traffic signal equipment
- (3) Disaster prevention equipment, crime prevention equipment
- (4) Medical devices classified as GHTF Class C (Japan Class III)
- (5) Highly public information network equipment, data-processing equipment (telephone exchange, and base station, etc.)
- (6) Any other equipment requiring high levels of quality and/or reliability equal to the equipment listed above

## 3. Equipment Prohibited for Use

Please do not incorporate our products into the following equipment requiring extremely high levels of safety and/or reliability.

- (1) Aerospace equipment (artificial satellite, rocket, etc.)
- (2) Aviation equipment \*1
- (3) Medical devices classified as GHTF Class D (Japan Class IV), implantable medical devices \*2
- (4) Power generation control equipment (nuclear power, hydroelectric power, thermal power plant control system, etc.)
- (5) Undersea equipment (submarine repeating equipment, etc.)
- (6) Military equipment
- (7) Any other equipment requiring extremely high levels of safety and/or reliability equal to the equipment listed above

\*Notes: 1. There is a possibility that our products can be used only for aviation equipment that does not directly affect the safe operation of aircraft (e.g., in-flight entertainment, cabin light, electric seat, cooking equipment) if such use meets requirements specified separately by TAIYO YUDEN. Please be sure to contact TAIYO YUDEN for further information before using our products for such aviation equipment.

2. Implantable medical devices contain not only internal unit which is implanted in a body, but also external unit which is connected to the internal unit.

## 4. Limitation of Liability

Please note that unless you obtain prior written consent of TAIYO YUDEN, TAIYO YUDEN shall not be in any way responsible for any damages incurred by you or third parties arising from use of the products listed in this catalog for any equipment that is not intended for use by TAIYO YUDEN, or any equipment requiring inquiry to TAIYO YUDEN or prohibited for use by TAIYO YUDEN as described above.

### ■ Safety Design

When using our products for high safety and/or reliability-required equipment or circuits, please fully perform safety and/or reliability evaluation. In addition, please install (i) systems equipped with a protection circuit and a protection device and/or (ii) systems equipped with a redundant circuit or other system to prevent an unsafe status in the event of a single fault for a failsafe design to ensure safety.

### ■ Intellectual Property Rights

Information contained in this catalog is intended to convey examples of typical performances and/or applications of our products and is not intended to make any warranty with respect to the intellectual property rights or any other related rights of TAIYO YUDEN or any third parties nor grant any license under such rights.

### ■ Limited Warranty

Please note that the scope of warranty for our products is limited to the delivered our products themselves conforming to the product specifications specified in the individual product specification sheets, and TAIYO YUDEN shall not be in any way responsible for any damages resulting from a failure or defect in our products. Notwithstanding the foregoing, if there is a written agreement (e.g., supply and purchase agreement, quality assurance agreement) signed by TAIYO YUDEN and your company, TAIYO YUDEN will warrant our products in accordance with such agreement, provided, however, that our products shall be used for general-purpose and standard use in the equipment specified in this catalog or the individual product specification sheets.

### ■ TAIYO YUDEN's Official Sales Channel

The contents of this catalog are applicable to our products which are purchased from our sales offices or authorized distributors (hereinafter "TAIYO YUDEN's official sales channel"). Please note that the contents of this catalog are not applicable to our products purchased from any seller other than TAIYO YUDEN's official sales channel.

### ■ Caution for Export

Some of our products listed in this catalog may require specific procedures for export according to "U.S. Export Administration Regulations", "Foreign Exchange and Foreign Trade Control Law" of Japan, and other applicable regulations. Should you have any questions on this matter, please contact our sales staff.

▶ This catalog contains the typical specification only due to the limitation of space. When you consider the purchase of our products, please check our product specification sheets. For details of each product (characteristics graph, reliability information, precautions for use, and so on), see our website (<http://www.ty-top.com/>).

# Automotive Application Guide

We classify automotive electronic equipment into the following four application categories and set usable application categories for each of our products. Therefore, we have the corresponding product series (the 2nd code from the left side of the part number is “A” or “C”). When using our products for automotive electronic equipment, please be sure to check such application categories and use the corresponding product series accordingly. Should you have any questions on this matter, please contact us.

Product Series (The 2nd Code from the Left Side of the Part Number)	Category	Automotive Electronic Equipment (Typical Example)
A	POWERTRAIN	<ul style="list-style-type: none"> <li>• Engine ECU (Electronically Controlled Fuel Injector)</li> <li>• Cruise Control Unit</li> <li>• 4WS (4 Wheel Steering)</li> <li>• Transmission</li> <li>• Power Steering</li> <li>• HEV/PHV/EV Core Control (Battery, Inverter, DC-DC)</li> <li>• Automotive Locator (Car location information providing device), etc.</li> </ul>
	SAFETY	<ul style="list-style-type: none"> <li>• ABS (Anti-Lock Brake System)</li> <li>• ESC (Electronic Stability Control)</li> <li>• Airbag</li> <li>• ADAS (Equipment that directly controls running, turning and stopping), etc.</li> </ul>
C	BODY & CHASSIS	<ul style="list-style-type: none"> <li>• Wiper</li> <li>• Automatic Door</li> <li>• Power Window</li> <li>• Keyless Entry System</li> <li>• Electric Door Mirror</li> <li>• Automobile Digital Mirror</li> <li>• Interior Lighting</li> <li>• Automobile Air Conditioning System</li> <li>• TPMS (Tire Pressure Monitoring System)</li> <li>• Anti-Theft Device (Immobilizer)</li> <li>• ADAS (Sensor, Equipment that is not interlocked with safety equipment or powertrain), etc.</li> </ul>
	INFOTAINMENT	<ul style="list-style-type: none"> <li>• Car Infotainment System</li> <li>• ITS/Telematics System</li> <li>• Instrument Cluster Panel</li> <li>• Dashcam (genuine products for automotive manufacturer), etc.</li> </ul>

# Wire-wound Ferrite Bead Inductors for Power Lines LCMC/LCMG series for Automotive Body & Chassis and Infotainment

Code in front of Series have been extracted from Part number, which describes the segment of products, such as kinds and characteristics.

AEC-Q200 Grade 3 (we conduct the evaluation at the test condition of Grade 3.)

\*Operating environment Temp:-40~85°C

REFLOW

AEC-Q200

## PART NUMBER

\*Operating Temp. : -40~125°C (Including self-generated heat)

L	C	M	C	C	3	2	1	6	1	1	T	8	0	0	R	G	
①	②	③	④	⑤	⑥	⑦	⑧										

## ①Series

Code (1)(2)(3)(4)	
LCMC	Wire-wound Ferrite Bead Inductors for Power Lines for Automotive Body & Chassis and Infotainment
LCMG	Wire-wound Ferrite Bead Inductors for Power Lines for Automotive Body & Chassis and Infotainment

## (1) Product Group

Code	
L	Inductors

## (2) Category

Code	Recommended equipment	Quality Grade
C	Automotive Electronic Equipment (Body & Chassis, Infotainment)	2

## ②Features

Code	Feature
A	Standard (20MHz)
C	Wave-shaping
G	For GHz noise

## ③Dimensions (L × W)

Code	Type (inch)	Dimensions (L × W) [mm]
1608	1608 (0603)	1.6 × 0.8
2012	2012 (0805)	2.0 × 1.25
2016	2016 (0806)	2.0 × 1.6
3216	3216 (1206)	3.2 × 1.6
3225	3225 (1210)	3.2 × 2.5
4516	4516 (1806)	4.5 × 1.6
4525	4525 (1810)	4.5 × 2.5

## ④Dimensions (T)

Code	Dimensions (T) [mm]
08	0.8 0.85
11	1.1
16	1.6
25	2.5

## (3) Type

Code	
M	Ferrite Wire-wound bead

## (4) Features, Characteristics

Code	
C	High current
G	High frequency

## ⑤Packaging

Code	Packaging
T	Taping

## ⑥Nominal impedance

Code (example)	Nominal impedance [Ω]
330	33
221	220
102	1000

## ⑦Impedance tolerance

Code	Impedance tolerance
R	±25%
N	±30%

## ⑧Internal code

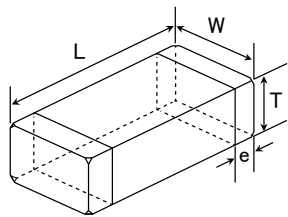
**STANDARD EXTERNAL DIMENSIONS / STANDARD QUANTITY**

**Recommended Land Patterns**
**Surface Mounting**

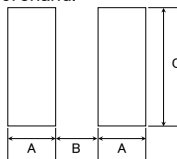
• Mounting and soldering conditions should be checked beforehand.



Type	A	B	C
1608	1.0	1.0	1.0
2012	1.4	1.2	1.65
2016	1.4	1.2	2.0
3216	1.4	2.2	2.0
3225	1.4	2.2	2.9
4516	1.75	3.5	2.0
4525	1.75	3.5	2.9

Unit: mm

Type	L	W	T	e	Standard quantity [pcs]	
					Paper tape	Embossed tape
160808 *1 (0603)	1.6±0.2 (0.063±0.008)	0.8±0.2 (0.031±0.008)	0.8±0.2 (0.031±0.008)	0.3±0.2 (0.012±0.008)	4000	—
160808 *2 (0603)	1.6±0.1 (0.063±0.004)	0.8±0.1 (0.031±0.004)	0.8±0.1 (0.031±0.004)	0.3±0.15 (0.012±0.006)	4000	—
201208 (0805)	2.0±0.2 (0.079±0.008)	1.25±0.2 (0.049±0.008)	0.85±0.2 (0.033±0.008)	0.5±0.3 (0.020±0.012)	4000	—
201616 (0806)	2.0±0.2 (0.079±0.008)	1.6±0.2 (0.063±0.008)	1.6±0.2 (0.063±0.008)	0.5±0.3 (0.020±0.012)	—	2000
321611 (1206)	3.2±0.3 (0.126±0.012)	1.6±0.2 (0.063±0.008)	1.1±0.2 (0.043±0.008)	0.5±0.3 (0.020±0.012)	—	2000
321616 (1206)	3.2±0.3 (0.126±0.012)	1.6±0.2 (0.063±0.008)	1.6±0.2 (0.063±0.008)	0.5±0.3 (0.020±0.012)	—	2000
322525 (1210)	3.2±0.3 (0.126±0.012)	2.5±0.3 (0.098±0.012)	2.5±0.3 (0.098±0.012)	0.5±0.3 (0.020±0.012)	—	1000
451611 (1806)	4.5±0.3 (0.177±0.012)	1.6±0.2 (0.063±0.008)	1.1±0.2 (0.043±0.008)	0.5±0.3 (0.020±0.012)	—	2000
451616 (1806)	4.5±0.3 (0.177±0.012)	1.6±0.2 (0.063±0.008)	1.6±0.2 (0.063±0.008)	0.5±0.3 (0.020±0.012)	—	2000
452525 (1810)	4.5±0.4 (0.177±0.016)	2.5±0.3 (0.098±0.012)	2.5±0.3 (0.098±0.012)	0.9±0.6 (0.035±0.024)	—	1000

\*1 LCMC, \*2 LCMG

Unit: mm (inch)

## PART NUMBER

• All the Wire-wound Ferrite Bead Inductors for Power Lines of the catalog lineup are RoHS compliant.

## Notes)

- The exchange of individual specifications is necessary depending on your application and/or circuit condition. Please contact TAIYO YUDEN's official sales channel.
- For Automotive (AEC-Q200 Qualified) products for BODY & CHASSIS, and INFOTAINMENT. Please check "Automotive Application Guide" for further details before using the products.

< AEC-Q200 : AEC-Q200 qualified >

All the Wire-wound Ferrite Bead Inductors for Power Lines for Automotive products are tested based on the test conditions and methods defined in AEC-Q200 by family item. Please consult with TAIYO YUDEN's official sales channel for the details of the product specifications and AEC-Q200 test results, etc., and please review and approve the product specifications before ordering.

## Standard type

## ● 1608 (0603) type

New part number	Old part number (for reference)	Nominal impedance ( $\Omega$ )	Impedance tolerance	Measuring frequency [MHz]	DC Resistance [ $\Omega$ ] (max.)	Rated current [A] (max.)	Thickness [mm]
LCMCC160808T280NG	FB MJ1608HS280NTV	28	$\pm 30\%$	100	0.007	4.0	0.8 $\pm$ 0.2
LCMCA160808T230NG	FB MJ1608HM230NTV	23	$\pm 30\%$	100	0.007	4.0	0.8 $\pm$ 0.2

## ● 2012 (0805) type

New part number	Old part number (for reference)	Nominal impedance ( $\Omega$ )	Impedance tolerance	Measuring frequency [MHz]	DC Resistance [ $\Omega$ ] (max.)	Rated current [A] (max.)	Thickness [mm]
LCMCC201208T250NG	FB MJ2125HS250NTV	25	$\pm 30\%$	100	0.004	6.0	0.85 $\pm$ 0.2
LCMCC201208T420RG	FB MJ2125HS420-TV	42	$\pm 25\%$	100	0.008	4.0	0.85 $\pm$ 0.2
LCMCA201208T210NG	FB MJ2125HM210NTV	21	$\pm 30\%$	100	0.004	6.0	0.85 $\pm$ 0.2
LCMCA201208T330RG	FB MJ2125HM330-TV	33	$\pm 25\%$	100	0.008	4.0	0.85 $\pm$ 0.2
LCMCG201208T8R0NG	FB MJ2125HL8R0NTV	8	$\pm 30\%$	100	0.008	4.0	0.85 $\pm$ 0.2

## ● 3216 (1206) type

New part number	Old part number (for reference)	Nominal impedance ( $\Omega$ )	Impedance tolerance	Measuring frequency [MHz]	DC Resistance [ $\Omega$ ] (max.)	Rated current [A] (max.)	Thickness [mm]
LCMCC321611T480NG	FB MJ3216HS480NTV	48	$\pm 30\%$	100	0.005	6.0	1.1 $\pm$ 0.2
LCMCC321611T800RG	FB MJ3216HS800-TV	80	$\pm 25\%$	100	0.010	4.0	1.1 $\pm$ 0.2
LCMCA321611T380NG	FB MJ3216HM380NTV	38	$\pm 30\%$	100	0.005	6.0	1.1 $\pm$ 0.2
LCMCA321611T600RG	FB MJ3216HM600-TV	60	$\pm 25\%$	100	0.010	4.0	1.1 $\pm$ 0.2
LCMCG321611T160NG	FB MJ3216HL160NTV	16	$\pm 30\%$	100	0.012	4.0	1.1 $\pm$ 0.2

## ● 4516 (1806) type

New part number	Old part number (for reference)	Nominal impedance ( $\Omega$ )	Impedance tolerance	Measuring frequency [MHz]	DC Resistance [ $\Omega$ ] (max.)	Rated current [A] (max.)	Thickness [mm]
LCMCC451611T720NG	FB MJ4516HS720NTV	72	$\pm 30\%$	100	0.007	6.0	1.1 $\pm$ 0.2
LCMCC451611T111RG	FB MJ4516HS111-TV	110	$\pm 25\%$	100	0.014	4.0	1.1 $\pm$ 0.2
LCMCA451611T560NG	FB MJ4516HM560NTV	56	$\pm 30\%$	100	0.007	6.0	1.1 $\pm$ 0.2
LCMCA451611T900RG	FB MJ4516HM900-TV	90	$\pm 25\%$	100	0.014	4.0	1.1 $\pm$ 0.2
LCMCG451611T230NG	FB MJ4516HL230NTV	23	$\pm 30\%$	100	0.014	3.5	1.1 $\pm$ 0.2

## High impedance type (GHz Band)

## ● 1608 (0603) type

New part number	Old part number (for reference)	Nominal impedance Measuring frequency 100 [MHz]		Nominal impedance Measuring frequency 1 [GHz]		DC Resistance [ $\Omega$ ] (max.)	Rated current [A] (max.)	Thickness [mm]
		( $\Omega$ )	tolerance	( $\Omega$ )	tolerance			
LCMGA160808T470RG	FB MH1608HM470-TV	47	$\pm 25\%$	75	$\pm 40\%$	0.020	3.5	0.8 $\pm$ 0.1
LCMGA160808T600RG	FB MH1608HM600-TV	60	$\pm 25\%$	100	$\pm 40\%$	0.025	3.0	0.8 $\pm$ 0.1
LCMGA160808T101RG	FB MH1608HM101-TV	100	$\pm 25\%$	170	$\pm 40\%$	0.035	2.5	0.8 $\pm$ 0.1
LCMGA160808T151RG	FB MH1608HM151-TV	150	$\pm 25\%$	270	$\pm 40\%$	0.050	2.1	0.8 $\pm$ 0.1
LCMGA160808T221RG	FB MH1608HM221-TV	220	$\pm 25\%$	370	$\pm 40\%$	0.070	1.8	0.8 $\pm$ 0.1
LCMGA160808T331RG	FB MH1608HM331-TV	330	$\pm 25\%$	520	$\pm 40\%$	0.130	1.2	0.8 $\pm$ 0.1
LCMGA160808T471RG	FB MH1608HM471-TV	470	$\pm 25\%$	750	$\pm 40\%$	0.150	1.0	0.8 $\pm$ 0.1
LCMGA160808T601RG	FB MH1608HM601-TV	600	$\pm 25\%$	900	$\pm 40\%$	0.170	0.9	0.8 $\pm$ 0.1
LCMGA160808T102RG	FB MH1608HM102-TV	1000	$\pm 25\%$	1200	$\pm 40\%$	0.350	0.6	0.8 $\pm$ 0.1
LCMGG160808T300RG	FB MH1608HL300-TV	30	$\pm 25\%$	120	$\pm 40\%$	0.028	2.6	0.8 $\pm$ 0.1
LCMGG160808T600RG	FB MH1608HL600-TV	60	$\pm 25\%$	220	$\pm 40\%$	0.045	2.1	0.8 $\pm$ 0.1
LCMGG160808T121RG	FB MH1608HL121-TV	120	$\pm 25\%$	540	$\pm 40\%$	0.130	1.2	0.8 $\pm$ 0.1
LCMGG160808T221RG	FB MH1608HL221-TV	220	$\pm 25\%$	950	$\pm 40\%$	0.170	0.9	0.8 $\pm$ 0.1
LCMGG160808T331RG	FB MH1608HL331-TV	330	$\pm 25\%$	1200	$\pm 40\%$	0.210	0.8	0.8 $\pm$ 0.1
LCMGG160808T471RG	FB MH1608HL471-TV	470	$\pm 25\%$	1500	$\pm 40\%$	0.350	0.6	0.8 $\pm$ 0.1
LCMGG160808T601RG	FB MH1608HL601-TV	600	$\pm 25\%$	1800	$\pm 40\%$	0.450	0.5	0.8 $\pm$ 0.1

※) The rated current is the value of current at which the temperature of the element is increased by 40 deg.

## PART NUMBER

High impedance type

● 2012 (0805) type

New part number	Old part number (for reference)	Nominal impedance ( $\Omega$ )	Impedance tolerance	Measuring frequency [MHz]	DC Resistance [ $\Omega$ ] (max.)	Rated current [A] (max.)	Thickness [mm]
LCMGA201208T800RG	FB MH2012HM800-TV	80	$\pm 25\%$	100	0.025	2.7	0.85 $\pm 0.2$
LCMGA201208T121RG	FB MH2012HM121-TV	120	$\pm 25\%$	100	0.032	2.5	0.85 $\pm 0.2$
LCMGA201208T221RG	FB MH2012HM221-TV	220	$\pm 25\%$	100	0.060	2.0	0.85 $\pm 0.2$
LCMGA201208T331RG	FB MH2012HM331-TV	330	$\pm 25\%$	100	0.080	1.8	0.85 $\pm 0.2$

● 2016 (0806) type

New part number	Old part number (for reference)	Nominal impedance ( $\Omega$ )	Impedance tolerance	Measuring frequency [MHz]	DC Resistance [ $\Omega$ ] (max.)	Rated current [A] (max.)	Thickness [mm]
LCMGA201616T121NG	FB MH2016HM121NTV	120	$\pm 30\%$	100	0.015	4.5	1.6 $\pm 0.2$
LCMGA201616T251NG	FB MH2016HM251NTV	250	$\pm 30\%$	100	0.050	2.0	1.6 $\pm 0.2$

● 3216 (1206) type

New part number	Old part number (for reference)	Nominal impedance ( $\Omega$ )	Impedance tolerance	Measuring frequency [MHz]	DC Resistance [ $\Omega$ ] (max.)	Rated current [A] (max.)	Thickness [mm]
LCMGA321616T221NG	FB MH3216HM221NTV	220	$\pm 30\%$	100	0.020	4.0	1.6 $\pm 0.2$
LCMGA321616T501NG	FB MH3216HM501NTV	500	$\pm 30\%$	100	0.070	2.0	1.6 $\pm 0.2$

● 3225 (1210) type

New part number	Old part number (for reference)	Nominal impedance ( $\Omega$ )	Impedance tolerance	Measuring frequency [MHz]	DC Resistance [ $\Omega$ ] (max.)	Rated current [A] (max.)	Thickness [mm]
LCMGA322525T601NG	FB MH3225HM601NTV	600	$\pm 30\%$	100	0.042	3.0	2.5 $\pm 0.3$
LCMGA322525T102NG	FB MH3225HM102NTV	1000	$\pm 30\%$	100	0.100	2.0	2.5 $\pm 0.3$
LCMGA322525T202NG	FB MH3225HM202NTV	2000	$\pm 30\%$	100	0.130	1.2	2.5 $\pm 0.3$

● 4516 (1806) type

New part number	Old part number (for reference)	Nominal impedance ( $\Omega$ )	Impedance tolerance	Measuring frequency [MHz]	DC Resistance [ $\Omega$ ] (max.)	Rated current [A] (max.)	Thickness [mm]
LCMGA451616T851NG	FB MH4516HM851NTV	850	$\pm 30\%$	100	0.100	1.5	1.6 $\pm 0.2$

● 4525 (1810) type

New part number	Old part number (for reference)	Nominal impedance ( $\Omega$ )	Impedance tolerance	Measuring frequency [MHz]	DC Resistance [ $\Omega$ ] (max.)	Rated current [A] (max.)	Thickness [mm]
LCMGA452525T102NG	FB MH4525HM102NTV	1000	$\pm 30\%$	100	0.060	3.0	2.5 $\pm 0.3$
LCMGA452525T162NG	FB MH4525HM162NTV	1600	$\pm 30\%$	100	0.130	2.0	2.5 $\pm 0.3$

● High current type

New part number	Old part number (for reference)	Nominal impedance ( $\Omega$ )	Impedance tolerance	Measuring frequency [MHz]	DC Resistance [ $\Omega$ ] (max.)	Rated current [A] (max.)	Thickness [mm]
LCMCC160808T220NGR	FB MJ1608HS220NTW	22	$\pm 30\%$	100	0.004	7.5	0.8 $\pm 0.2$
LCMCC160808T280NGR	FB MJ1608HS280NTW	28	$\pm 30\%$	100	0.006	6.0	0.8 $\pm 0.2$
LCMCA160808T180NGR	FB MJ1608HM180NTW	18	$\pm 30\%$	100	0.004	7.5	0.8 $\pm 0.2$
LCMCA160808T230NGR	FB MJ1608HM230NTW	23	$\pm 30\%$	100	0.006	6.0	0.8 $\pm 0.2$

※) The rated current is the value of current at which the temperature of the element is increased by 40 deg.

ELECTRICAL CHARACTERISTICS

Standard type  
 ■ 1608 type

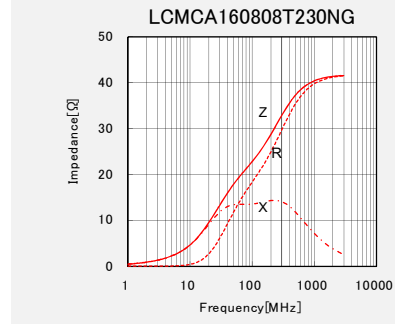
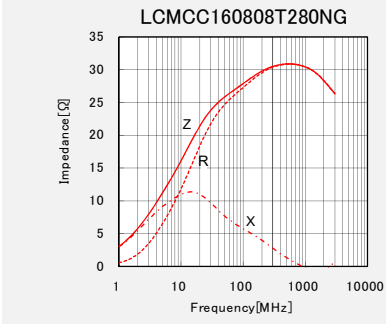

■ 2012 type

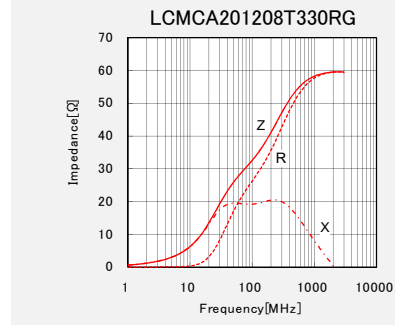
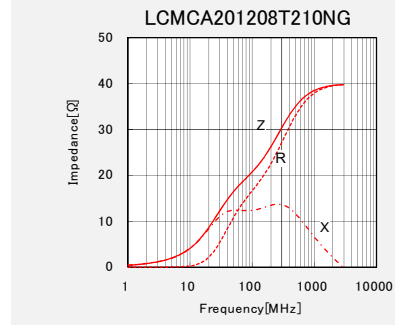
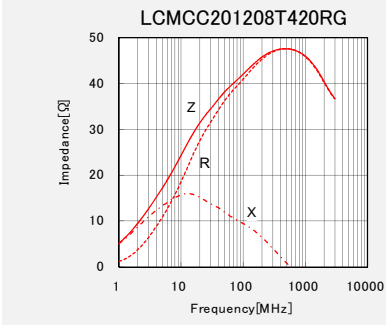
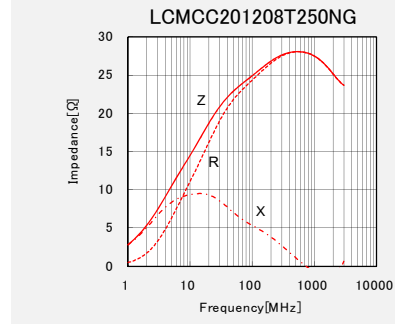

■ 3216 type

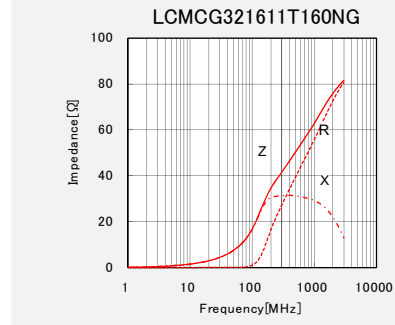
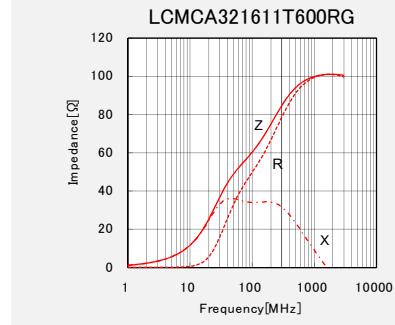
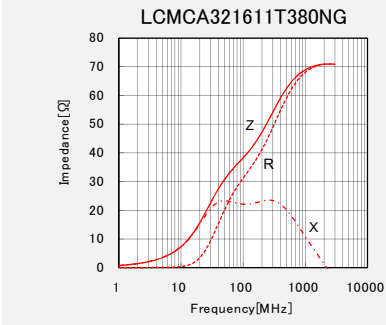
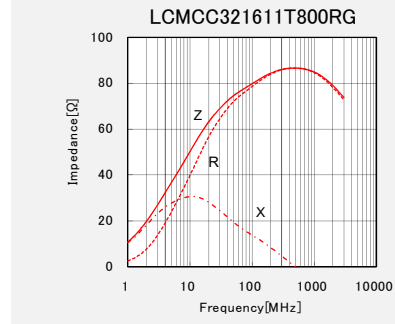
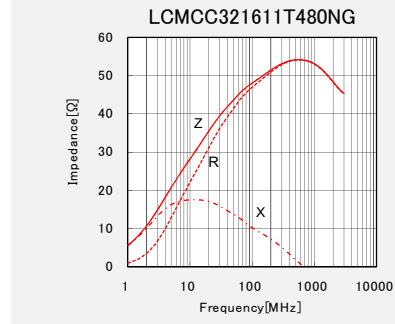
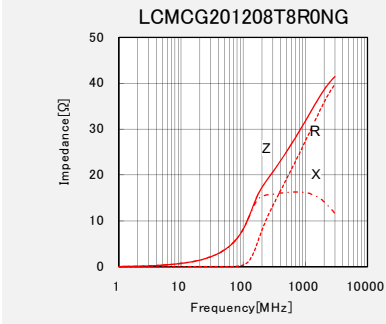

■ 4516 type

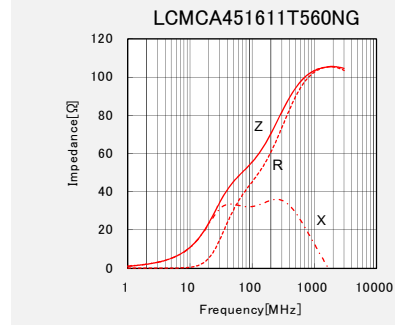
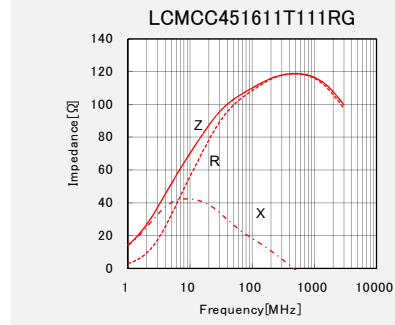
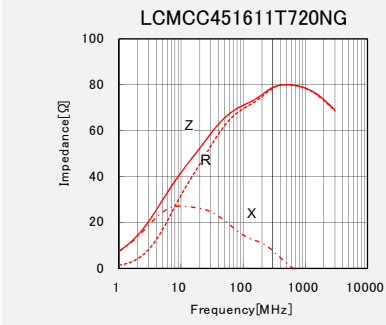

▶ This catalog contains the typical specification only due to the limitation of space. When you consider the purchase of our products, please check our specification. For details of each product (characteristics graph, reliability information, precautions for use, and so on), see our Web site (<http://www.ty-top.com/>).



ELECTRICAL CHARACTERISTICS

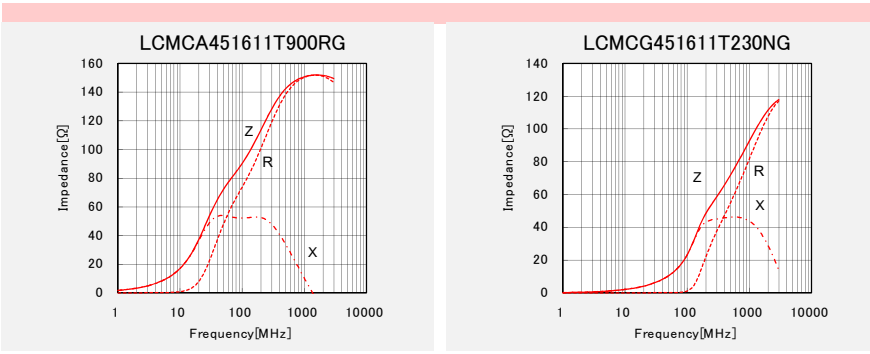

High impedance type(GHz Band)

■ 1608 type

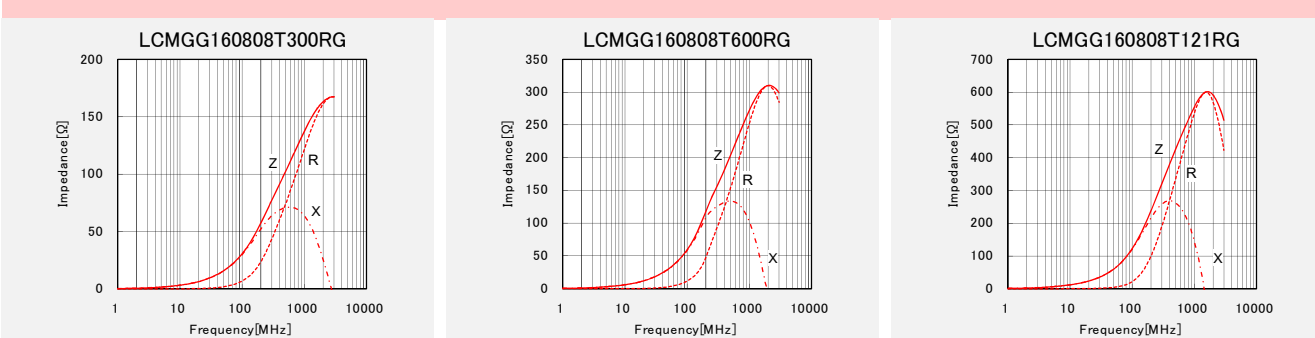
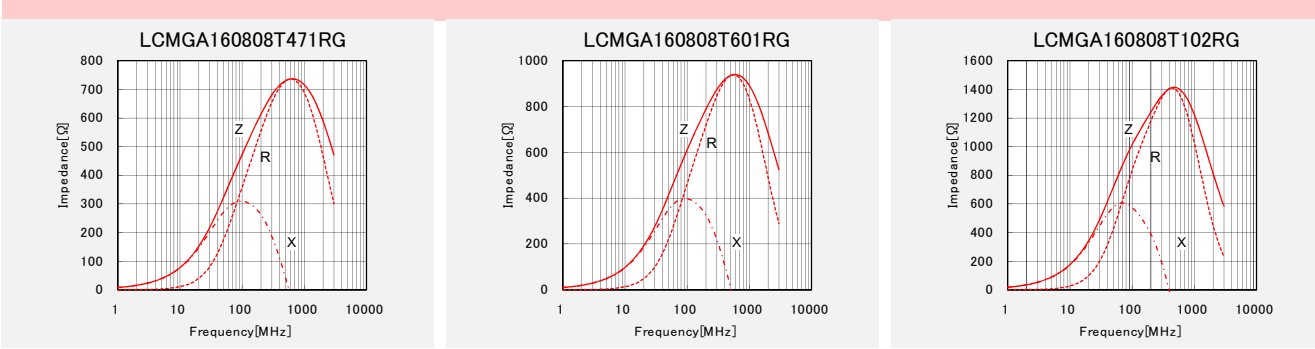
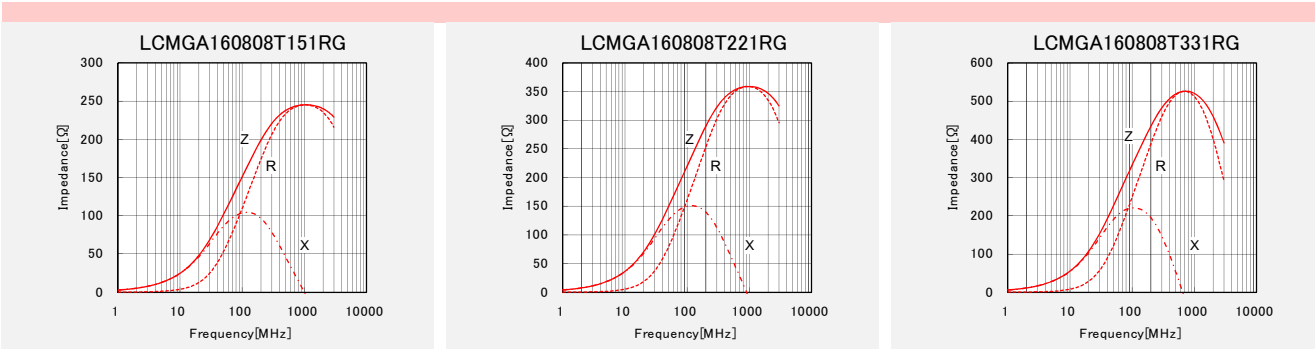
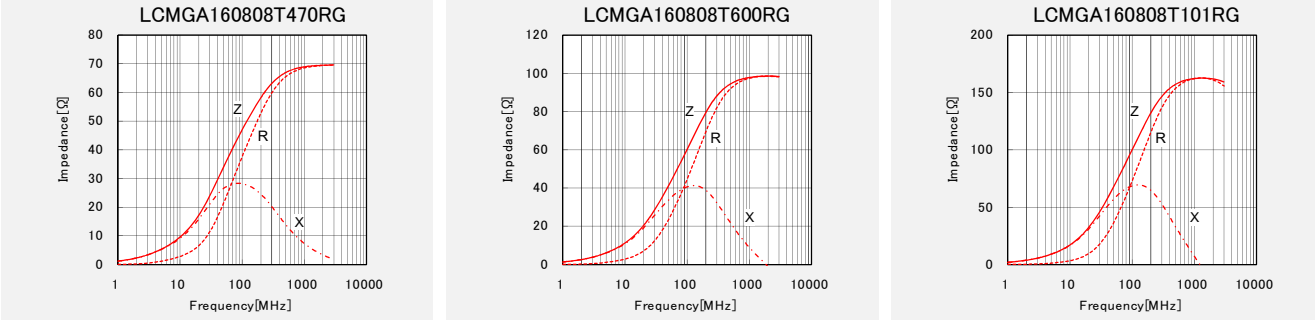

▶ This catalog contains the typical specification only due to the limitation of space. When you consider the purchase of our products, please check our specification. For details of each product (characteristics graph, reliability information, precautions for use, and so on), see our Web site (<http://www.ty-top.com/>).

ELECTRICAL CHARACTERISTICS

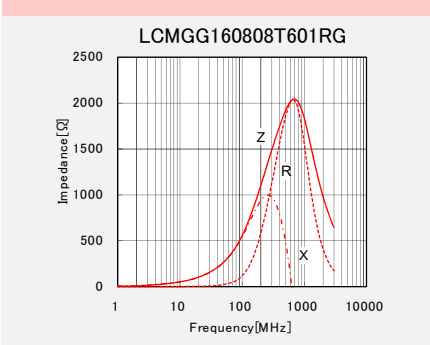
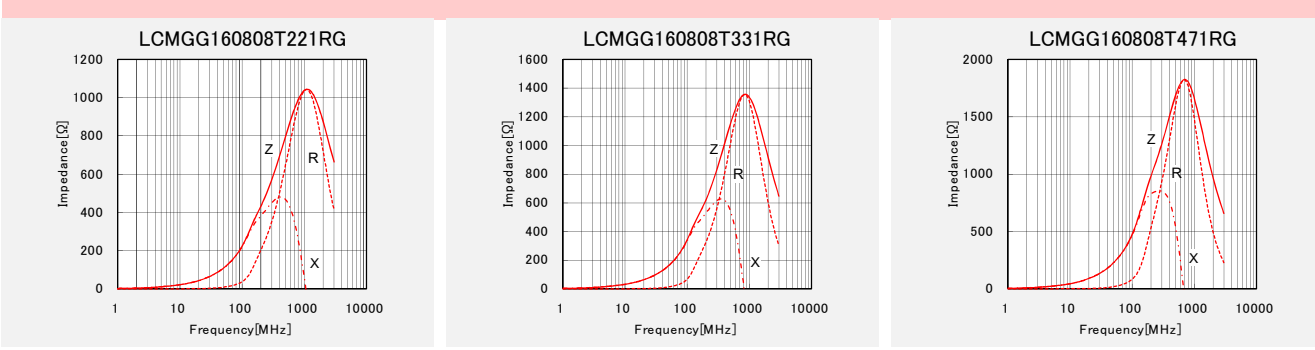

High impedance type

■ 2012 type

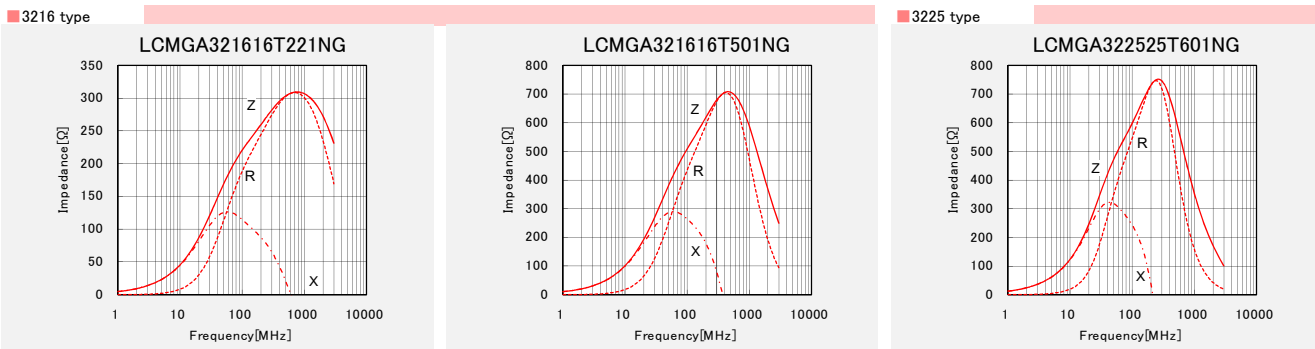
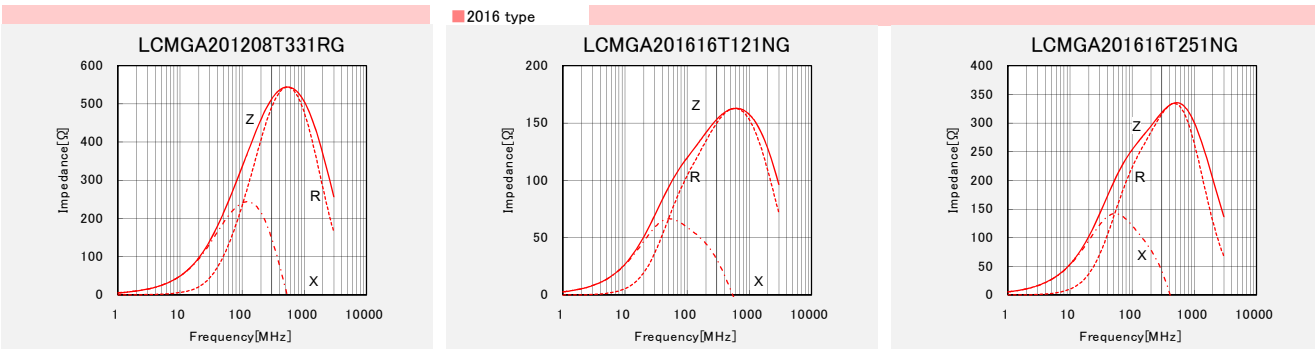
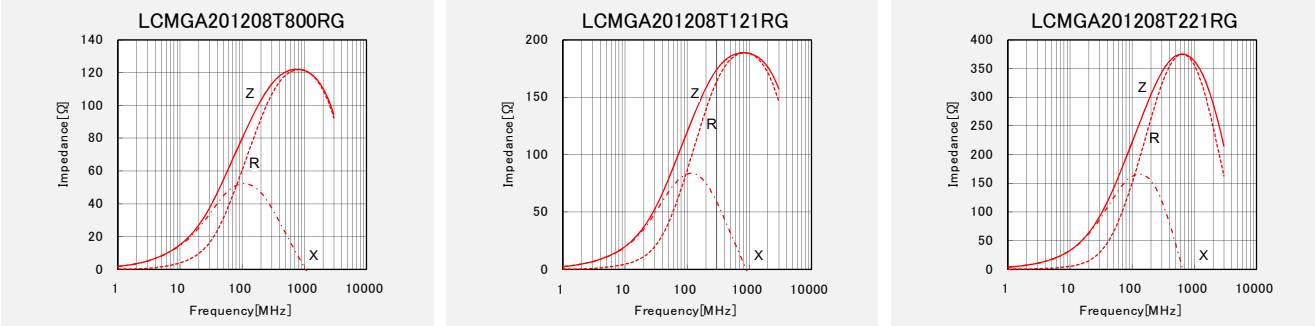

▶ This catalog contains the typical specification only due to the limitation of space. When you consider the purchase of our products, please check our specification. For details of each product (characteristics graph, reliability information, precautions for use, and so on), see our Web site (<http://www.ty-top.com/>).

ELECTRICAL CHARACTERISTICS

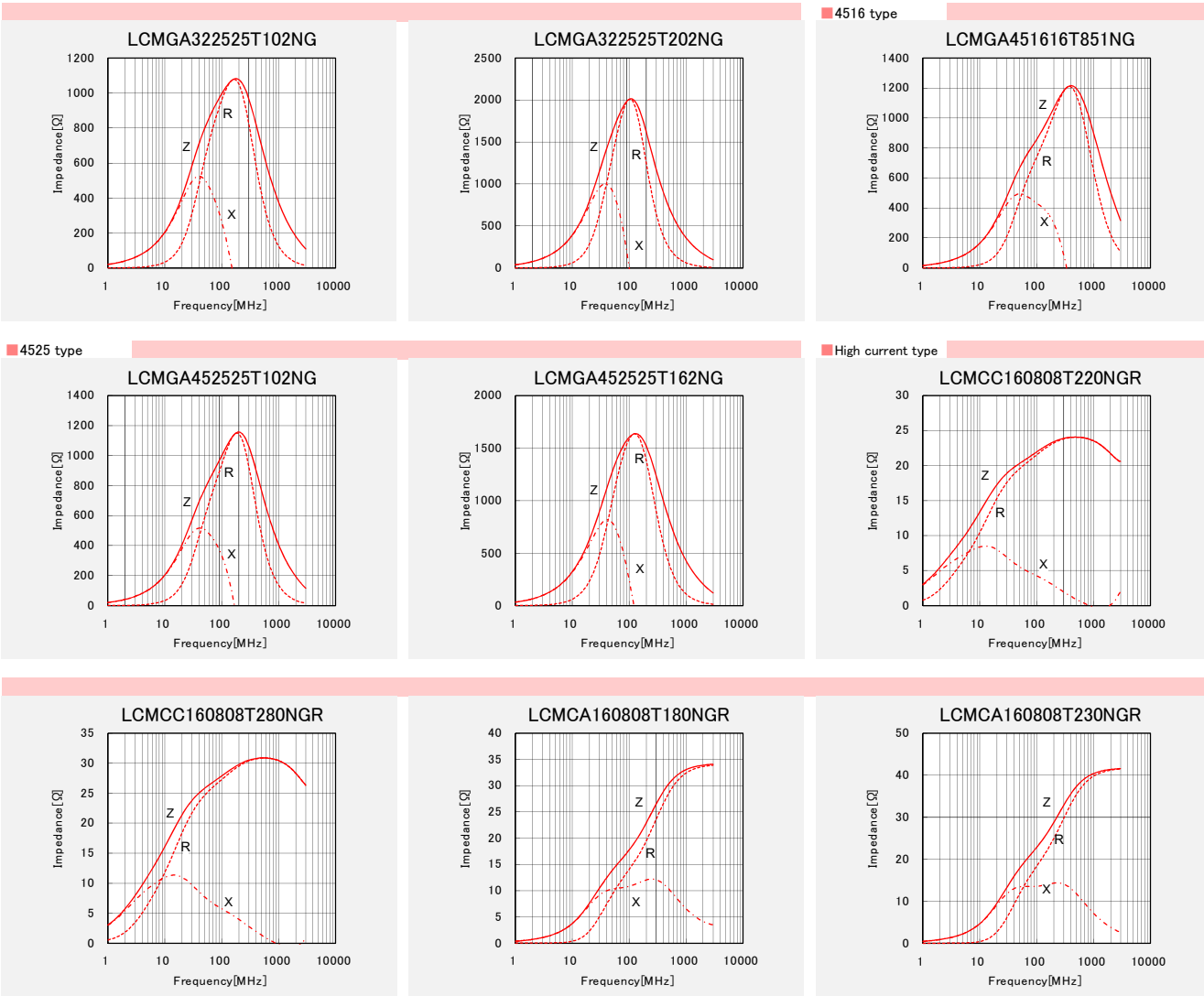

Derating of Rated Current

LCMC/LCMG series

Derating of current is necessary for LCMC/LCMG series depending on ambient temperature. Please refer to the chart shown below for appropriate derating of current.

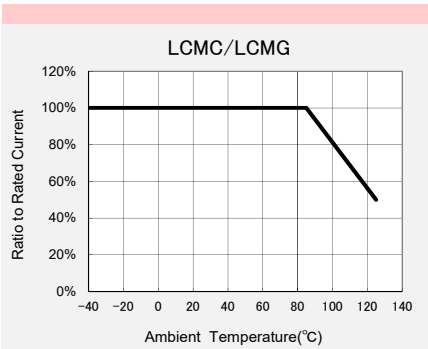

This catalog contains the typical specification only due to the limitation of space. When you consider the purchase of our products, please check our specification. For details of each product (characteristics graph, reliability information, precautions for use, and so on), see our Web site (<http://www.ty-top.com/>).

# Wire-wound Ferrite Bead Inductors for Power Lines LSMC/LSMG/LAMG/LCMC/LCMG/LBMC/LBMG/LLMC/LLMG/LMMC/LMMG series

## PACKAGING

### ① Minimum Quantity

Type	Standard Quantity [pcs]	
	Paper Tape	Embossed Tape
1608(0603)	4000	—
2125(0805)	4000	—
2012(0805)	4000	—
2016(0806)	—	2000
3216(1206)	—	2000
3225(1210)	—	1000
4516(1806)	—	2000
4525(1810)	—	1000
4532(1812)	—	2000

### ② Tape Material

- Card board carrier tape

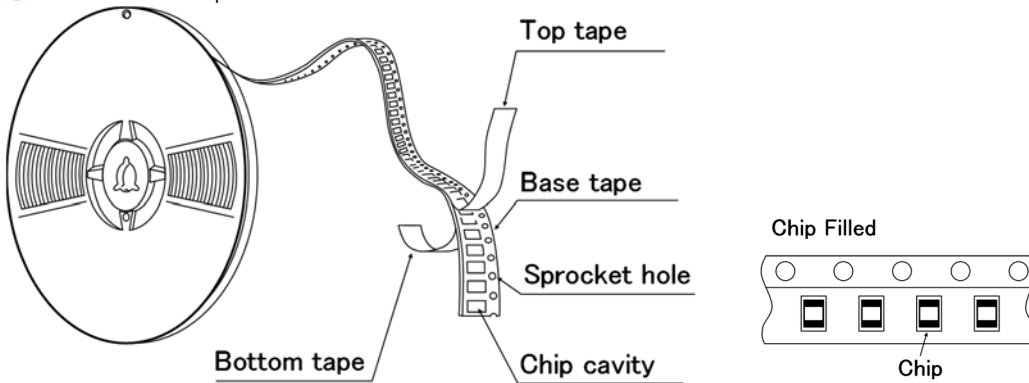

- Embossed tape

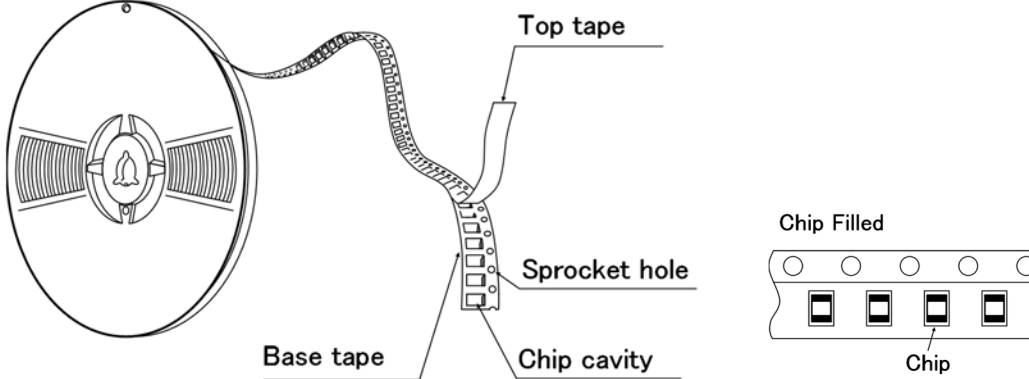

### ③ Taping Dimensions

- Paper tape (0.315 inches wide)

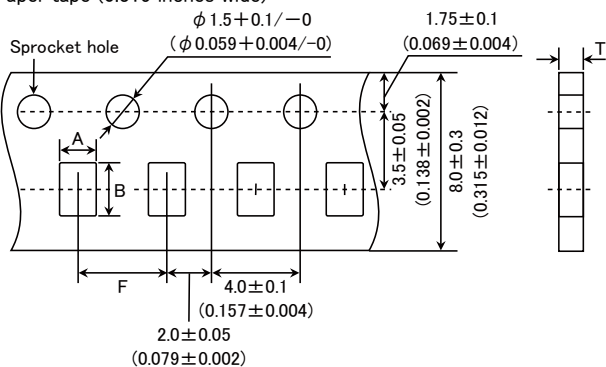

► This catalog contains the typical specification only due to the limitation of space. When you consider the purchase of our products, please check our specification. For details of each product (characteristics graph, reliability information, precautions for use, and so on), see our Web site (<http://www.ty-top.com/>).

Type	Chip Cavity		Insertion Pitch	Tape Thickness
	A	B		
1608 (0603)	1.0±0.2 (0.039±0.008)	1.8±0.2 (0.071±0.008)	4.0±0.2 (0.157±0.008)	1.1max (0.043max)
2012 (0805)	1.5±0.2 (0.059±0.008)	2.3±0.2 (0.091±0.008)	4.0±0.2 (0.157±0.008)	1.1max (0.043max)

Unit : mm (inch)

● Embossed tape (0.315 inches wide)

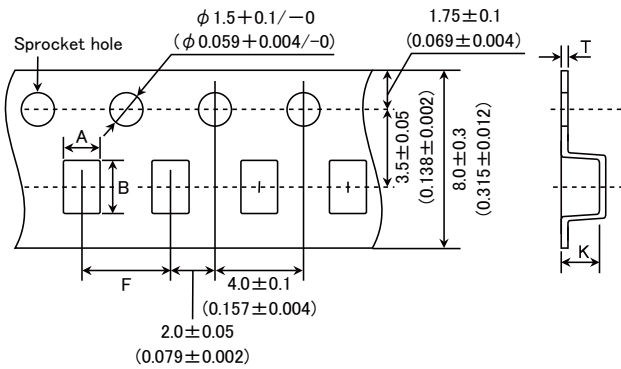

Type	Chip Cavity		Insertion Pitch	Tape Thickness	
	A	B		K	T
2016 (0806)	1.8±0.2 (0.071±0.008)	2.2±0.2 (0.087±0.008)	4.0±0.2 (0.157±0.008)	2.6max (0.102max)	0.6max (0.024max)
3216 *1 (1206)	1.9±0.2 (0.075±0.008)	3.5±0.2 (0.138±0.008)	4.0±0.2 (0.157±0.008)	1.5max (0.059max)	0.3max (0.012max)
3216 *2 (1206)	1.9±0.2 (0.075±0.008)	3.5±0.2 (0.138±0.008)	4.0±0.2 (0.157±0.008)	2.6max (0.102max)	0.6max (0.024max)
3225 (1210)	2.8±0.2 (0.110±0.008)	3.5±0.2 (0.138±0.008)	4.0±0.2 (0.157±0.008)	4.0max (0.157max)	0.6max (0.024max)

Unit : mm (inch)

\*1 LSMC/LCMC/LBMC/LLMC/LMMC

\*2 LSMG/LAMG/LCMG/LBMG/LLMG/LMMG

● Embossed tape (0.472 inches wide)

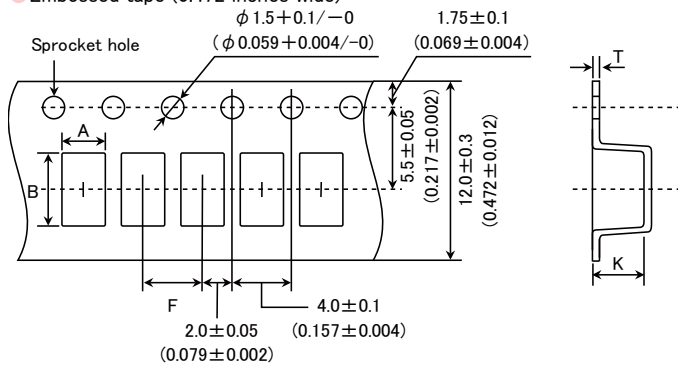

Type	Chip Cavity		Insertion Pitch	Tape Thickness	
	A	B		K	T
4516 *1 (1806)	1.9±0.2 (0.075±0.008)	4.9±0.2 (0.193±0.008)	4.0±0.2 (0.157±0.008)	1.5max (0.059max)	0.3max (0.012max)
4516 *2 (1806)	1.9±0.2 (0.075±0.008)	4.9±0.2 (0.193±0.008)	4.0±0.2 (0.157±0.008)	2.6max (0.102max)	0.6max (0.024max)
4525 (1810)	2.9±0.2 (0.114±0.008)	4.9±0.2 (0.193±0.008)	4.0±0.2 (0.157±0.008)	4.0max (0.157max)	0.6max (0.024max)
4532 (1812)	3.6±0.2 (0.142±0.008)	4.9±0.2 (0.193±0.008)	8.0±0.2 (0.315±0.008)	4.0max (0.157max)	0.6max (0.024max)

Unit : mm (inch)

\*1 LSMC/LCMC/LBMC/LLMC/LMMC

\*2 LSMG/LAMG/LCMG/LBMG/LLMG/LMMG

▶ This catalog contains the typical specification only due to the limitation of space. When you consider the purchase of our products, please check our specification. For details of each product (characteristics graph, reliability information, precautions for use, and so on), see our Web site (<http://www.ty-top.com/>).

#### ④ Leader and Blank portion

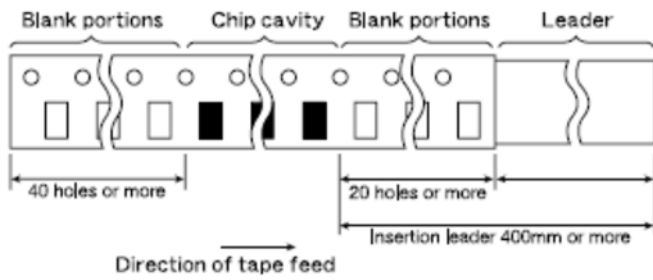

Insertion leader is 400 mm or more (including 20 empty cavities)  
 Empty cavities at end of reel: 40 holes or more

#### ⑤ Reel size

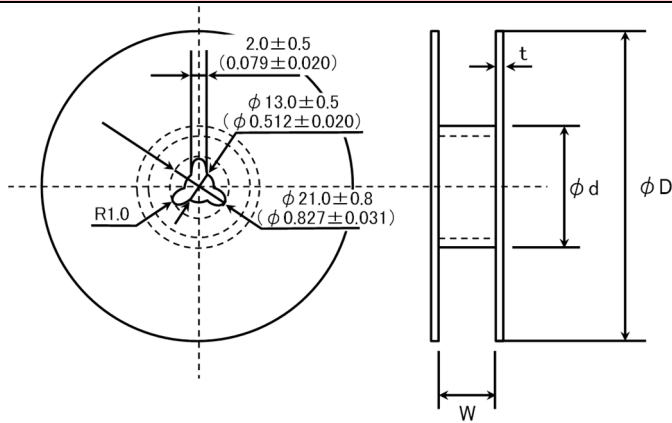

Type	$\phi D$	$\phi d$	W	t
1608(0603) 2012(0805) 2016(0806) 3216(1206) 3225(1210)	180+0/-3 (7.09+0/-0.118)	60+1/-0 (2.36+0.039/-0)	10.0±1.5 (0.394±0.059)	2.5max (0.098max)
4516(1806) 4525(1810)			14.0±1.5 (0.551±0.059)	
4532(1812)	330±2.0 (12.99±0.080)	100±1.0 (3.94±0.039)	14.0±2.0 (0.551±0.080)	3.0max (1.181max)

Unit : mm (inch)

#### ⑥ Top tape strength

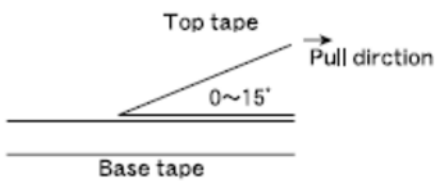

The top tape requires a peel-off force of 0.1 to 1.0N (0.315 inches wide) / 0.1 to 1.3N (0.472 inches wide) in the direction of the arrow as illustrated below.

## Wire-wound Ferrite Power Inductors LCXN/LCXP series

### RELIABILITY DATA

#### 1. Operating Temperature Range

Specified Value	-40~+125°C (Including self-generated heat)
Test Methods and Remarks	Including self-generated heat

#### 2. Storage Temperature Range

Specified Value	-40~+85°C
Test Methods and Remarks	-5 to 40°C for the product with taping.

#### 3. Rated current

Specified Value	Within the specified tolerance
-----------------	--------------------------------

#### 4. Impedance

Specified Value	Within the specified tolerance
Test Methods and Remarks	Measuring equipment : Impedance analyzer (HP4291A) or its equivalent Measuring frequency : 100±1 MHz

#### 5. DC Resistance

Specified Value	Within the specified tolerance
-----------------	--------------------------------

#### 6. High Temperature Exposure (Storage)

Specified Value	Appearance: No significant abnormality in appearance. Impedance change : Within ±30% of the initial value
Test Methods and Remarks	1000 hours at 125 deg C Unpowered

#### 7. Temperature Cycling

Specified Value	Appearance: No significant abnormality in appearance. Impedance change : Within +50/-10% of the initial value
Test Methods and Remarks	1000 cycles (-40 deg C to +125 deg C) 30 min. maximum dwell time at each temperature extreme. 1 min. maximum transition time.

#### 8. Biased Humidity

Specified Value	Appearance: No significant abnormality in appearance. Impedance change : Within ±30% of the initial value
Test Methods and Remarks	1000 hours, 85 deg C/85% RH. Rated current

#### 9. Operational Life

Specified Value	Appearance: No significant abnormality in appearance. Impedance change : Within ±30% of the initial value
Test Methods and Remarks	1000 hours, 85 deg C Rated current

► This catalog contains the typical specification only due to the limitation of space. When you consider the purchase of our products, please check our specification. For details of each product (characteristics graph, reliability information, precautions for use, and so on), see our Web site (<http://www.ty-top.com/>).

### 10. Resistance to Solvents

Specified Value	Appearance : No significant abnormality in appearance.
Test Methods and Remarks	① Soak a test sample in isopropyl alcohol (IPA) at $25 \pm 5$ deg C for 3 to 3.5 minutes. ② Take the test sample out and brush 10 times using a brush soaked in IPA. ③ Repeat ① and ② twice more.

### 11. Mechanical Shock

Specified Value	Appearance : No significant abnormality in appearance. Impedance change : Within $\pm 30\%$ of the initial value
Test Methods and Remarks	Apply 3 shocks in each direction along 3 mutually perpendicular axes of the test specimen (18 shocks in total). Peak value: 100g Duration: 6ms Test pulse: Half-sine Velocity change: 3.7m/s.

### 12. Vibration

Specified Value	Appearance : No significant abnormality in appearance. Impedance change : Within $\pm 30\%$ of the initial value
Test Methods and Remarks	5g's for 20 min., 12 cycles each of 3 orientations (36 cycles in total) Test from: 10 Hz to 2000 Hz

### 13. Resistance to Soldering Heat (Reflow)

Specified Value	Appearance : No significant abnormality in appearance. Impedance change : Within $\pm 30\%$ of the initial value
Test Methods and Remarks	Reflow peak temperature: $260 \pm 5$ deg C Duration time: $10 \pm 1$ sec. Measure after inductors are kept at room temperature for $24 \pm 4$ hours.

### 14. ESD

Specified Value	Appearance : No significant abnormality in appearance. Impedance change : Within $\pm 30\%$ of the initial value
Test Methods and Remarks	Per AEC-Q200-002

### 15. Solderability

Specified Value	More than 90% of terminal electrode shall be covered with fresh solder.
Test Methods and Remarks	Per J-STD-002 a) Method B Solder at $235 \pm 5$ deg C for 5 sec. c) Method D Solder at $260 \pm 5$ deg C for 30 sec.

### 16. Board Flex

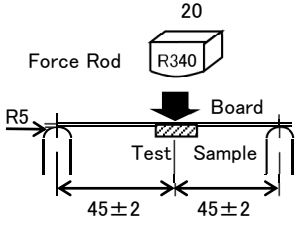
Specified Value	Appearance : No significant abnormality in appearance. Impedance change : Within $\pm 30\%$ of the initial value
Test Methods and Remarks	Solder the test samples to the test boards by the reflow soldering. Apply a force in a downward direction until amount of deflection reaches 2mm. The 2-mm deflection shall be held for 60 sec. Test board dimensions: 100mm × 40mm × 1.6mm. 

► This catalog contains the typical specification only due to the limitation of space. When you consider the purchase of our products, please check our specification. For details of each product (characteristics graph, reliability information, precautions for use, and so on), see our Web site (<http://www.ty-top.com/>).

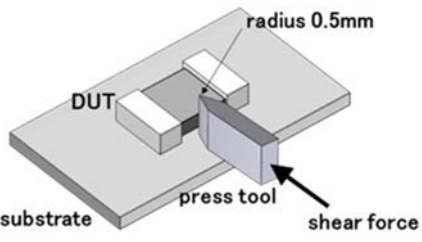

**17. Terminal Strength (SMD)**

Specified Value	Appearance :No significant abnormality in appearance.
Test Methods and Remarks	<p>Apply a force of 17.7N for 60±5 sec.</p>  <p>The diagram shows a 3D perspective view of the test setup. A rectangular substrate is shown in light gray. On top of it, a small component labeled 'DUT' is mounted. A 'press tool' is shown in a darker gray, positioned to apply force to the component. The tool has a rounded end with a 'radius 0.5mm'. An arrow labeled 'shear force' points to the right, indicating the direction of the applied force on the component's lead.</p>

**18. Standard condition**

Specified Value	<p>Note on standard condition: "standard condition" referred to herein is defined as follows:          5 to 35°C of temperature, 45 to 85% relative humidity and 86 to 106kPa of air pressure.          When there are questions concerning measurement results:          In order to provide correlation data, the test shall be conducted under condition of 20±2°C of temperature, 60 to 70% relative humidity and 86 to 106kPa of air pressure. Unless otherwise specified, all the tests are conducted under the "standard condition."</p>
-----------------	---

► This catalog contains the typical specification only due to the limitation of space. When you consider the purchase of our products, please check our specification.  
 For details of each product (characteristics graph, reliability information, precautions for use, and so on), see our Web site (<http://www.ty-top.com/>).

# Wire-wound Ferrite Bead Inductors for Power Lines LSMC/LSMG/LAMG/LCMC/LCMG/LBMC/LBMG/LLMC/LLMG/LMMC/LMMG series

## ■ PRECAUTIONS

### 1. Circuit Design

Precautions	<ul style="list-style-type: none"> <li>◆ Verification of operating environment, electrical rating and performance               <ol style="list-style-type: none"> <li>1. A malfunction in medical equipment, spacecraft, nuclear reactors, etc. may cause serious harm to human life or have severe social ramifications. As such, any inductors to be used in such equipment may require higher safety and/or reliability considerations and should be clearly differentiated from components used in general purpose applications.</li> <li>2. When inductors are used in places where dew condensation develops and/or where corrosive gas such as hydrogen sulfide, sulfurous acid, or chlorine exists in the air, characteristic deterioration may occur. Please do not use inductors under such environmental conditions.</li> </ol> </li> <li>◆ Operating Current (Verification of Rated current)               <ol style="list-style-type: none"> <li>1. The operating current including inrush current for inductors must always be lower than their rated values.</li> <li>2. Do not apply current in excess of the rated value because the inductance may be reduced due to the magnetic saturation effect.</li> </ol> </li> <li>◆ Temperature rise               <p>Temperature rise of power choke coil depends on the installation condition in end products.</p> <p>Make sure that temperature rise of power choke coils in actual end products is within the specified temperature range.</p> </li> </ul>
-------------	--

### 2. PCB Design

Precautions	<ul style="list-style-type: none"> <li>◆ Land pattern design               <ol style="list-style-type: none"> <li>1. Please refer to a recommended land pattern.</li> </ol> </li> </ul>
-------------	---

### 3. Considerations for automatic placement

Precautions	<ul style="list-style-type: none"> <li>◆ Adjustment of mounting machine               <ol style="list-style-type: none"> <li>1. Excessive impact load should not be imposed on the products when mounting onto the PC boards.</li> <li>2. Mounting and soldering conditions should be checked beforehand.</li> </ol> </li> </ul>
Technical considerations	<ul style="list-style-type: none"> <li>◆ Adjustment of mounting machine               <ol style="list-style-type: none"> <li>1. When installing products, care should be taken not to apply distortion stress as it may deform the products.</li> </ol> </li> </ul>

### 4. Soldering

Precautions	<ul style="list-style-type: none"> <li>◆ Wave soldering               <ol style="list-style-type: none"> <li>1. Please refer to the specifications in the catalog for a wave soldering.</li> </ol> </li> <li>◆ Reflow soldering               <ol style="list-style-type: none"> <li>1. Please contact any of our offices for a reflow soldering, and refer to the recommended condition specified.</li> </ol> </li> <li>◆ Lead free soldering               <ol style="list-style-type: none"> <li>1. When using products with lead free soldering, we request to use them after confirming adhesion, temperature of resistance to soldering heat, etc. sufficiently.</li> </ol> </li> <li>◆ Preheating when soldering               <p>Heating : The temperature difference between soldering and remaining heat should not be greater than 150°C.</p> <p>Cooling : The temperature difference between the components and cleaning process should not be greater than 100°C.</p> </li> <li>◆ Recommended conditions for using a soldering iron               <p>Put the soldering iron on the land-pattern.</p> <p>Soldering iron's temperature – Below 350°C</p> <p>Duration – 3 seconds or less</p> <p>The soldering iron should not directly touch the inductor.</p> </li> </ul>
-------------	---

Technical considerations	<ul style="list-style-type: none"> <li>◆ Wave, Reflow, Lead free soldering               <ol style="list-style-type: none"> <li>1. If products are used beyond the range of the recommended conditions, heat stresses may deform the products, and consequently degrade the reliability of the products.</li> </ol> <p><b>【Recommended reflow condition】</b></p> </li> <li>◆ Preheating when soldering               <ol style="list-style-type: none"> <li>1. There is a case that products get damaged by a heat shock.</li> </ol> </li> </ul>
--------------------------	--

► This catalog contains the typical specification only due to the limitation of space. When you consider the purchase of our products, please check our specification. For details of each product (characteristics graph, reliability information, precautions for use, and so on), see our Web site (<http://www.ty-top.com/>).