



LDE SERIES – DIGITAL LOW DIFFERENTIAL PRESSURE SENSORS

The LDE differential low-pressure sensors are based on thermal flow measurement of gas through a micro-flow channel integrated within the sensor chip. The innovative LDE technology features superior sensitivity especially for ultra-low pressures. The extremely low gas flow through the sensor ensures high immunity to dust contamination, humidity and long tubing compared to other flow-based pressure sensors.

Features

- Ultra-low-pressure ranges from 25 to 500 Pa (0.1 to 2 inH₂O)
- Pressure sensor based on thermal micro-flow measurement
- High flow impedance
- very low flow-through leakage
- high immunity to dust and humidity
- no loss in sensitivity using long tubing
- Calibrated and temperature compensated
- Unique offset autozeroing feature ensuring superb long-term stability
- Offset accuracy better than 0.2% FS
- Total accuracy better than 0.5% FS typical
- On-chip temperature sensor
- Analog output and digital SPI interface
- No position sensitivity

Certificates

- Quality Management System according to EN ISO 13485 and EN ISO 9001
- RoHS and REACH compliant

Media compatibility

Air and other non-corrosive gases

Applications

Medical

- Ventilators
- Spirometers
- CPAP
- Sleep diagnostic equipment
- Nebulizers
- Oxygen conservers/concentrators
- Insufflators/endoscopy

Industrial

- HVAC
- VAV
- Filter monitoring
- Burner control
- Fuel cells
- Gas leak detection
- Gas metering
- Fume hood
- Instrumentation
- Security systems

CLICK HERE ›
CONNECT WITH A SPECIALIST

LDE SERIES – DIGITAL LOW DIFFERENTIAL PRESSURE SENSORS

Maximum ratings

| Parameter | | Min. | Max. | Unit |
|---|------------|------|------|----------|
| Supply voltage V_s | LDExxx3xxx | 2.70 | 3.60 | V_{DC} |
| | LDExxx6xxx | 4.75 | 5.25 | |
| Output current | | | 1 | mA |
| Soldering recommendation | | | | |
| Reflow soldering ^(1,2) | | | | |
| Average preheating temperature gradient | | | 1.5 | K/s |
| Time above 217 °C | | | 74 | s |
| Time above 240 °C | | | 30 | |
| Peak temperature | | | 245 | °C |
| Cooling temperature gradient | | | -1.4 | K/s |
| Wave soldering, pot temperature | | | 260 | °C |
| Hand soldering, tip temperature | | | 370 | |
| Temperature ranges | | | | |
| Compensated | | 0 | +70 | °C |
| Operating | | -20 | +80 | |
| Storage | | -40 | +80 | |
| Humidity limits (nin-condensing) | | | 97 | %RH |
| Vibration ⁽³⁾ | | | 20 | g |
| Mechanical shock ⁽⁴⁾ | | | 500 | |

Pressure sensor characteristics

| Part no. | Operating pressure | Proof pressure ⁽⁵⁾ | Burst pressure ⁽⁵⁾ |
|-------------|--|-------------------------------|-------------------------------|
| LDES025Uxxx | 0 to 25 Pa / 0 to 0.25 mbar (0.1 inH2O) | 2 bar (30 psi) | 5 bar (75 psi) |
| LDES050Uxxx | 0 to 50 Pa / 0 to 0.5 mbar (0.2 inH2O) | | |
| LDES100Uxxx | 0 to 100 Pa / 0 to 1 mbar (0.4 inH2O) | | |
| LDES250Uxxx | 0 to 250 Pa / 0 to 2.5 mbar (1 inH2O) | | |
| LDES500Uxxx | 0 to 500 Pa / 0 to 5 mbar (2 inH2O) | | |
| LDES025Bxxx | 0 to ±25 Pa / 0 to ±0.25 mbar (±0.1 inH2O) | | |
| LDES050Bxxx | 0 to ±50 Pa / 0 to ±0.5 mbar (±0.2 inH2O) | | |
| LDES100Bxxx | 0 to ±100 Pa / 0 to ±1 mbar (±0.4 inH2O) | | |
| LDES250Bxxx | 0 to ±250 Pa / 0 to ±2.5 mbar (±1 inH2O) | | |
| LDES500Bxxx | 0 to ±500 Pa / 0 to ±5 mbar (±2 inH2O) | | |

Gas correction factors ⁽⁶⁾

| Gas type | Correction factor |
|-----------------------------------|-------------------|
| Dry air | 1.0 |
| Oxygen (O ₂) | 1.07 |
| Nitrogen (N ₂) | 0.97 |
| Argon (Ar) | 0.98 |
| Carbon dioxide (CO ₂) | 0.56 |

LDE SERIES – DIGITAL LOW DIFFERENTIAL PRESSURE SENSORS

LDExxx6xxx Performance characteristics ⁽⁷⁾

(V_S=5.0 V_{DC}, T_A=20 °C, P_{Abs}=1 bara, calibrated in air, analog and digital output signals are non-ratiometric to V_S)

25 Pa and 50 Pa devices

| Parameter | Min. | Typ. | Max. | Unit |
|--|------|-------|-----------------|--------------|
| Noise level (RMS) | | ±0.01 | | Pa |
| Offset warm-up shift | | | less than noise | |
| Offset long term stability ⁽⁸⁾ | | ±0.05 | ±0.1 | Pa/year |
| Offset repeatability | | ±0.01 | | Pa |
| Span repeatability ^(11,12) | | ±0.25 | | % of reading |
| Current consumption (no load) ⁽⁹⁾ | | 7 | 8 | mA |
| Response time (t ₆₃) | | 5 | | ms |
| Power-on time | | | 25 | ms |

Digital output

| Parameter | Min. | Typ. | Max. | Unit | |
|---|---------------------|------------|-------|--------------|--------------|
| Scale factor (digital output) ⁽¹⁰⁾ | 0 to 25/0 to ±25 Pa | 1200 | | counts/Pa | |
| | 0 to 50/0 to ±50 Pa | 600 | | counts/Pa | |
| Zero pressure offset accuracy ⁽¹¹⁾ | | ±0.1 | ±0.2 | %FSS | |
| Span accuracy ^(11,12) | | ±0.4 | ±0.75 | % of reading | |
| Thermal effects | Offset | 5 to 55 °C | | ±0.2 | %FSS |
| | | 0 to 70 °C | | ±0.4 | %FSS |
| | Span | 5 to 55 °C | ±1 | ±1.75 | % of reading |
| | | 0 to 70 °C | ±2 | ±2.75 | % of reading |

Analog output (unidirectional devices)

| Parameter | Min. | Typ. | Max. | Unit | |
|--------------------------------------|--------|------------|-------|--------------|--------------|
| Zero pressure offset ⁽¹¹⁾ | 0.49 | 0.50 | 0.51 | V | |
| Full scale output | | 4.50 | | V | |
| Span accuracy ^(11,12) | | ±0.4 | ±0.75 | % of reading | |
| Thermal effects | Offset | 5 to 55 °C | | ±15 | mV |
| | | 0 to 70 °C | | ±30 | mV |
| | Span | 5 to 55 °C | ±1.25 | ±2 | % of reading |
| | | 0 to 70 °C | ±2 | ±2.75 | % of reading |

LDE SERIES – DIGITAL LOW DIFFERENTIAL PRESSURE SENSORS

Analog output (bidirectional devices)

| Parameter | | Min. | Typ. | Max. | Unit | |
|--------------------------------------|----------------------------|------------|------|-------|--------------|--------------|
| Zero pressure offset ⁽¹¹⁾ | | 2.49 | 2.50 | 2.51 | V | |
| Output | at max. specified pressure | | 4.50 | | V | |
| | at min. specified pressure | | 0.50 | | V | |
| Span accuracy ^(11,12) | | | ±0.4 | ±0.75 | % of reading | |
| Thermal effects | Offset | 5 to 55 °C | | | ±15 | mV |
| | | 0 to 70 °C | | | ±30 | mV |
| | Span | 5 to 55 °C | | ±1.25 | ±2 | % of reading |
| | | 0 to 70 °C | | ±2 | ±2.75 | % of reading |

LDExxx6xxx Performance characteristics (cont.)⁽⁷⁾

(V_S=5.0 V_{DC}, T_A=20 °C, P_{Abs}=1 bara, calibrated in air, analog and digital output signals are non-ratiometric to V_S)

100 Pa, 250 Pa and 500 Pa devices

| Parameter | Min. | Typ. | Max. | Unit |
|--|------|-------|-----------------|--------------|
| Noise level (RMS) | | ±0.01 | | %FSS |
| Offset warm-up shift | | | less than noise | |
| Offset long term stability ⁽⁸⁾ | | ±0.05 | ±0.1 | %FSS/year |
| Offset repeatability ⁽¹³⁾ | | ±0.02 | | Pa |
| Span repeatability ^(11,12) | | ±0.25 | | % of reading |
| Current consumption (no load) ⁽⁹⁾ | | 7 | 8 | mA |
| Response time (t ₆₃) | | 5 | | ms |
| Power-on time | | | 25 | ms |

Digital output

| Parameter | | Min. | Typ. | Max. | Unit | |
|---|-----------------------|------------|-------|-------|--------------|--------------|
| Scale factor (digital output) ⁽¹⁰⁾ | 0 to 100/0 to ±100 Pa | | 300 | | counts/Pa | |
| | 0 to 250/0 to ±250 Pa | | 120 | | | |
| | 0 to 500/0 to ±500 Pa | | 60 | | | |
| Zero pressure offset accuracy ⁽¹¹⁾ | | | ±0.05 | ±0.1 | %FSS | |
| Span accuracy ^(11,12) | | | ±0.4 | ±0.75 | % of reading | |
| Thermal effects | Offset | 5 to 55 °C | | | ±0.1 | %FSS |
| | | 0 to 70 °C | | | ±0.2 | %FSS |
| | Span | 5 to 55 °C | | ±1 | ±1.75 | % of reading |
| | | 0 to 70 °C | | ±2 | ±2.75 | % of reading |

Analog output (unidirectional devices)

| Parameter | | Min. | Typ. | Max. | Unit | |
|--------------------------------------|--------|------------|------|-------|--------------|--------------|
| Zero pressure offset ⁽¹¹⁾ | | 0.49 | 0.50 | 0.51 | V | |
| Full scale output | | | 4.50 | | V | |
| Span accuracy ^(11,12) | | | ±0.4 | ±0.75 | % of reading | |
| Thermal effects | Offset | 5 to 55 °C | | | ±10 | mV |
| | | 0 to 70 °C | | | ±12 | mV |
| | Span | 5 to 55 °C | | ±1 | ±1.75 | % of reading |
| | | 0 to 70 °C | | ±2 | ±2.75 | % of reading |

LDE SERIES – DIGITAL LOW DIFFERENTIAL PRESSURE SENSORS

Analog output (bidirectional devices)

| Parameter | | Min. | Typ. | Max. | Unit | |
|--------------------------------------|----------------------------|------------|------|-------|--------------|--------------|
| Zero pressure offset ⁽¹¹⁾ | | 2.49 | 2.50 | 2.51 | V | |
| Output | at max. specified pressure | | 4.50 | | V | |
| | at min. specified pressure | | 0.50 | | V | |
| Span accuracy ^(11,12) | | | ±0.4 | ±0.75 | % of reading | |
| Thermal effects | Offset | 5 to 55 °C | | ±10 | mV | |
| | | 0 to 70 °C | | ±12 | mV | |
| | Span | 5 to 55 °C | | ±1 | ±1.75 | % of reading |
| | | 0 to 70 °C | | ±2 | ±2.75 | % of reading |

LDExxx3xxx Performance characteristics ⁽⁷⁾

(V_S=3.0 V_{DC}, T_A=20 °C, P_{Abs}=1 bara, calibrated in air, analog and digital output signals are non-ratiometric to V_S)

25 Pa and 50 Pa devices

| Parameter | Min. | Typ. | Max. | Unit |
|--|------|-------|-----------------|--------------|
| Noise level (RMS) | | ±0.01 | | Pa |
| Offset warm-up shift | | | less than noise | |
| Offset long term stability ⁽⁸⁾ | | ±0.05 | ±0.1 | Pa/year |
| Offset repeatability | | ±0.01 | | Pa |
| Span repeatability ^(11,12) | | ±0.25 | | % of reading |
| Current consumption (no load) ⁽⁹⁾ | | 14 | 16 | mA |
| Response time (t ₆₃) | | 5 | | ms |
| Power-on time | | | 25 | ms |

Digital output

| Parameter | | Min. | Typ. | Max. | Unit | |
|---|---------------------|------------|------|-------|--------------|--------------|
| Scale factor (digital output) ⁽¹⁰⁾ | 0 to 25/0 to ±25 Pa | | 1200 | | counts/Pa | |
| | 0 to 50/0 to ±50 Pa | | 600 | | counts/Pa | |
| Zero pressure offset accuracy ⁽¹¹⁾ | | | ±0.1 | ±0.2 | %FSS | |
| Span accuracy ^(11,12) | | | ±0.4 | ±0.75 | % of reading | |
| Thermal effects | Offset | 5 to 55 °C | | ±0.2 | %FSS | |
| | | 0 to 70 °C | | ±0.4 | %FSS | |
| | Span | 5 to 55 °C | | ±1 | ±1.75 | % of reading |
| | | 0 to 70 °C | | ±2 | ±2.75 | % of reading |

LDE SERIES – DIGITAL LOW DIFFERENTIAL PRESSURE SENSORS

Analog output (unidirectional devices)

| Parameter | | | Min. | Typ. | Max. | Unit |
|--------------------------------------|--------|------------|------|-------|-------|--------------|
| Zero pressure offset ⁽¹¹⁾ | | | 0.29 | 0.30 | 0.31 | V |
| Full scale output | | | | 2.70 | | V |
| Span accuracy ^(11,12) | | | | ±0.4 | ±0.75 | % of reading |
| Thermal effects | Offset | 5 to 55 °C | | | ±15 | mV |
| | | 0 to 70 °C | | | ±30 | mV |
| | Span | 5 to 55 °C | | ±1.25 | ±2 | % of reading |
| | | 0 to 70 °C | | ±2 | ±2.75 | % of reading |

Analog output (bidirectional devices)

| Parameter | | | Min. | Typ. | Max. | Unit |
|--------------------------------------|----------------------------|------------|------|-------|-------|--------------|
| Zero pressure offset ⁽¹¹⁾ | | | 1.49 | 1.50 | 1.51 | V |
| Output | at max. specified pressure | | | 2.70 | | V |
| | at min. specified pressure | | | 0.30 | | V |
| Span accuracy ^(11,12) | | | | ±0.4 | ±0.75 | % of reading |
| Thermal effects | Offset | 5 to 55 °C | | | ±15 | mV |
| | | 0 to 70 °C | | | ±30 | mV |
| | Span | 5 to 55 °C | | ±1.25 | ±2 | % of reading |
| | | 0 to 70 °C | | ±2 | ±2.75 | % of reading |

LDExxx3xxx Performance characteristics (cont.) ⁽⁷⁾

(V_S=3.0 V_{DC}, T_A=20 °C, P_{Abs}=1 bara, calibrated in air, analog and digital output signals are non-ratiometric to V_S)

100 Pa, 250 Pa and 500 Pa devices

| Parameter | Min. | Typ. | Max. | Unit |
|--|------|-------|-----------------|--------------|
| Noise level (RMS) | | ±0.01 | | %FSS |
| Offset warm-up shift | | | less than noise | |
| Offset long term stability ⁽⁸⁾ | | ±0.05 | ±0.1 | %FSS/year |
| Offset repeatability ⁽¹³⁾ | | ±0.02 | | Pa |
| Span repeatability ^(11,12) | | ±0.25 | | % of reading |
| Current consumption (no load) ⁽⁹⁾ | | 14 | 16 | mA |
| Response time (t ₆₃) | | 5 | | ms |
| Power-on time | | | 25 | ms |

LDE SERIES – DIGITAL LOW DIFFERENTIAL PRESSURE SENSORS

Digital output

| Parameter | | Min. | Typ. | Max. | Unit |
|---|-----------------------|------------|-------|-------|--------------|
| Scale factor (digital output) ⁽¹⁰⁾ | 0 to 100/0 to ±100 Pa | | 300 | | counts/Pa |
| | 0 to 250/0 to ±250 Pa | | 120 | | |
| | 0 to 500/0 to ±500 Pa | | 60 | | |
| Zero pressure offset accuracy ⁽¹¹⁾ | | | ±0.05 | ±0.1 | %FSS |
| Span accuracy ^(11,12) | | | ±0.4 | ±0.75 | % of reading |
| Thermal effects | Offset | 5 to 55 °C | | ±0.1 | %FSS |
| | | 0 to 70 °C | | ±0.2 | %FSS |
| | Span | 5 to 55 °C | ±1 | ±1.75 | % of reading |
| | | 0 to 70 °C | ±2 | ±2.75 | % of reading |

Analog output (unidirectional devices)

| Parameter | | Min. | Typ. | Max. | Unit |
|--------------------------------------|--------|------------|------|-------|--------------|
| Zero pressure offset ⁽¹¹⁾ | | 0.29 | 0.30 | 0.31 | V |
| Full scale output | | | 2.70 | | V |
| Span accuracy ^(11,12) | | | ±0.4 | ±0.75 | % of reading |
| Thermal effects | Offset | 5 to 55 °C | | ±10 | mV |
| | | 0 to 70 °C | | ±12 | mV |
| | Span | 5 to 55 °C | ±1 | ±1.75 | % of reading |
| | | 0 to 70 °C | ±2 | ±2.75 | % of reading |

Analog output (bidirectional devices)

| Parameter | | Min. | Typ. | Max. | Unit |
|--------------------------------------|----------------------------|------------|------|-------|--------------|
| Zero pressure offset ⁽¹¹⁾ | | 1.49 | 1.50 | 1.51 | V |
| Output | at max. specified pressure | | 2.70 | | V |
| | at min. specified pressure | | 0.30 | | V |
| Span accuracy ^(11,12) | | | ±0.4 | ±0.75 | % of reading |
| Thermal effects | Offset | 5 to 55 °C | | ±10 | mV |
| | | 0 to 70 °C | | ±12 | mV |
| | Span | 5 to 55 °C | ±1 | ±1.75 | % of reading |
| | | 0 to 70 °C | ±2 | ±2.75 | % of reading |

Performance characteristics

Temperature sensor

| Parameter | Min. | Typ. | Max. | Unit |
|-------------------------------|------|------|------|-----------|
| Scale factor (digital output) | | 95 | | counts/°C |
| Non-linearity | | ±0.5 | | %FS |
| Hysteresis | | ±0.1 | | %FS |

Total accuracy ⁽¹⁴⁾

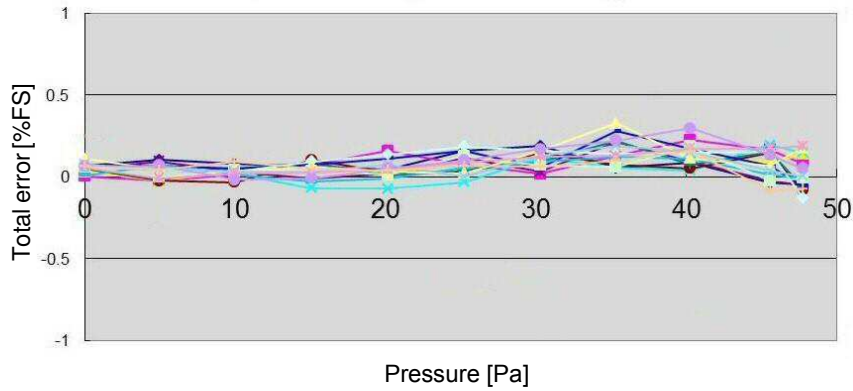

Fig. 1: Typical total accuracy plot of 16 LDE 50 Pa sensors @ 25 °C (typical total accuracy better than 0.5 %FS)

Offset long term stability

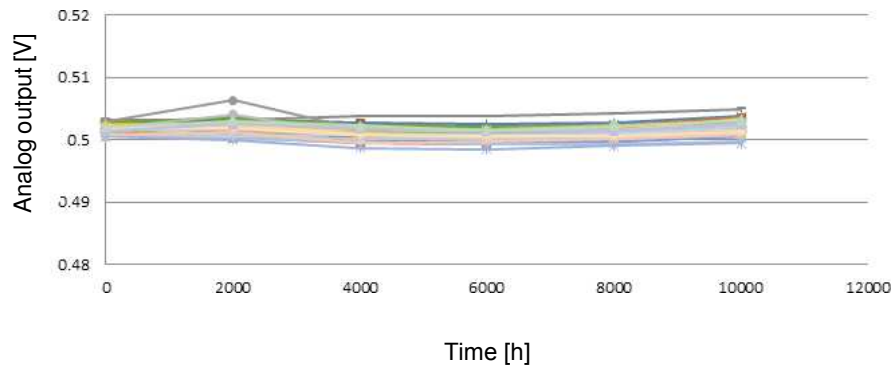

Fig. 2: Offset long term stability for LDE 250 Pa sensors after 10,000 hours @ 85°C powered, equivalent to over 43.5 years @ 25 °C (better than ±2 mV / ±0.125 Pa)

SPI – Serial Peripheral Interface

Note: it is important to adhere to the communication protocol in order to avoid damage to the sensor.

Introduction

The LDE serial interface is a high-speed synchronous data input and output communication port. The serial interface operates using a standard 4-wire SPI bus. The LDE device runs in SPI mode 0, which requires the clock line SCLK to idle low (CPOL = 0), and for data to be sampled on the leading clock edge (CPHA = 0). Figure 5 illustrates this mode of operation.

Care should be taken to ensure that the sensor is properly connected to the master microcontroller. Refer to the manufacturer's datasheet for more information regarding physical connections.

Application circuit

The use of pull-up resistors is generally unnecessary for SPI as most master devices are configured for push-pull mode. If pull-up resistors are required for use with 3 V LDE devices, however, they should be greater than 50 kΩ.

There are, however, some cases where it may be helpful to use 33Ω series resistors at both ends of the SPI lines, as shown in Figure 3.

Signal quality may be further improved by the addition of a buffer as shown in Figure 4. These cases include multiple slave devices on the same bus segment, using a master device with limited driving capability and long SPI bus lines.

If these series resistors are used, they must be physically placed as close as possible to the pins of the master and slave devices.

Signal control

The serial interface is enabled by asserting /CS low. The serial input clock, SCLK, is gated internally to begin accepting the input data at MOSI or sending the output data on MISO. When /CS rises, the data clocked into MOSI is loaded into an internal register.

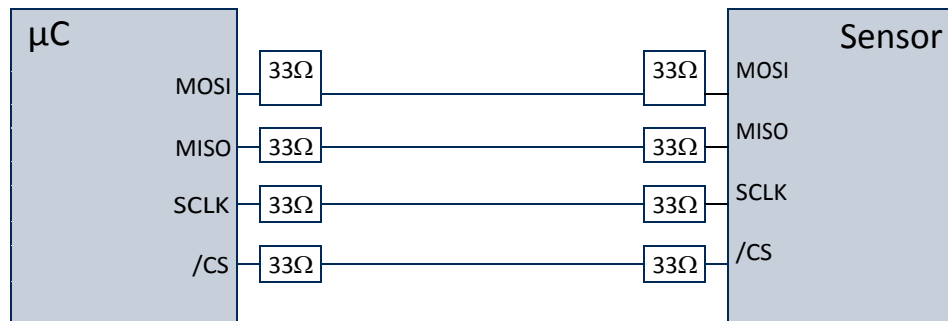

Fig. 3: Application circuit with resistors at both ends of the SPI lines

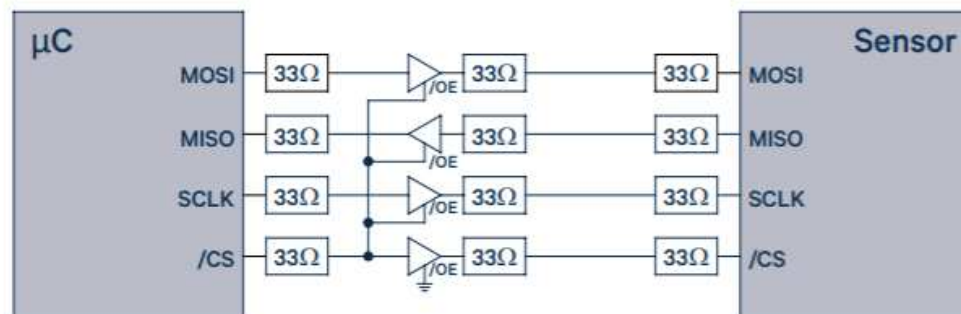

Fig. 4: Application circuit with additional buffer

SPI – Serial Peripheral Interface (cont.)

Note: it is important to adhere to the communication protocol in order to avoid damage to the sensor.

Data read – pressure

When powered on, the sensor begins to continuously measure pressure. To initiate data transfer from the sensor, the following three unique bytes must be written sequentially, MSB first, to the MOSI pin (see Figure 5):

| Step | Hexadecimal | Binary | Description |
|------|-------------|-----------|-----------------------------------|
| 1 | 0x2D | B00101101 | Poll current pressure measurement |
| 2 | 0x14 | B00010100 | Send result to data register |
| 3 | 0x98 | B10011000 | Read data register |

The entire 16 bit content of the LDE register is then read out on the MISO pin, MSB first, by applying 16 successive clock pulses to SCLK with /CS asserted low. Note that the value of the LSB is held at zero for internal signal processing purposes. This is below the noise threshold of the sensor and thus its fixed value does not affect sensor performance and accuracy.

From the digital sensor output the actual pressure value can be calculated as follows:

$$\text{Pressure [Pa]} = \frac{\text{Digital output [counts]}}{\text{Scale factor} \left[\frac{\text{counts}}{\text{Pa}} \right]}$$

For example, for a ±250 Pa sensor (LDES250Bxxx) with a scale factor of 120 a digital output of 30 000 counts (7530'h) calculates to a positive pressure of 250 Pa. Similarly, a digital output of -30 000 counts (8AD0'h) calculates to a negative pressure of -250 Pa.

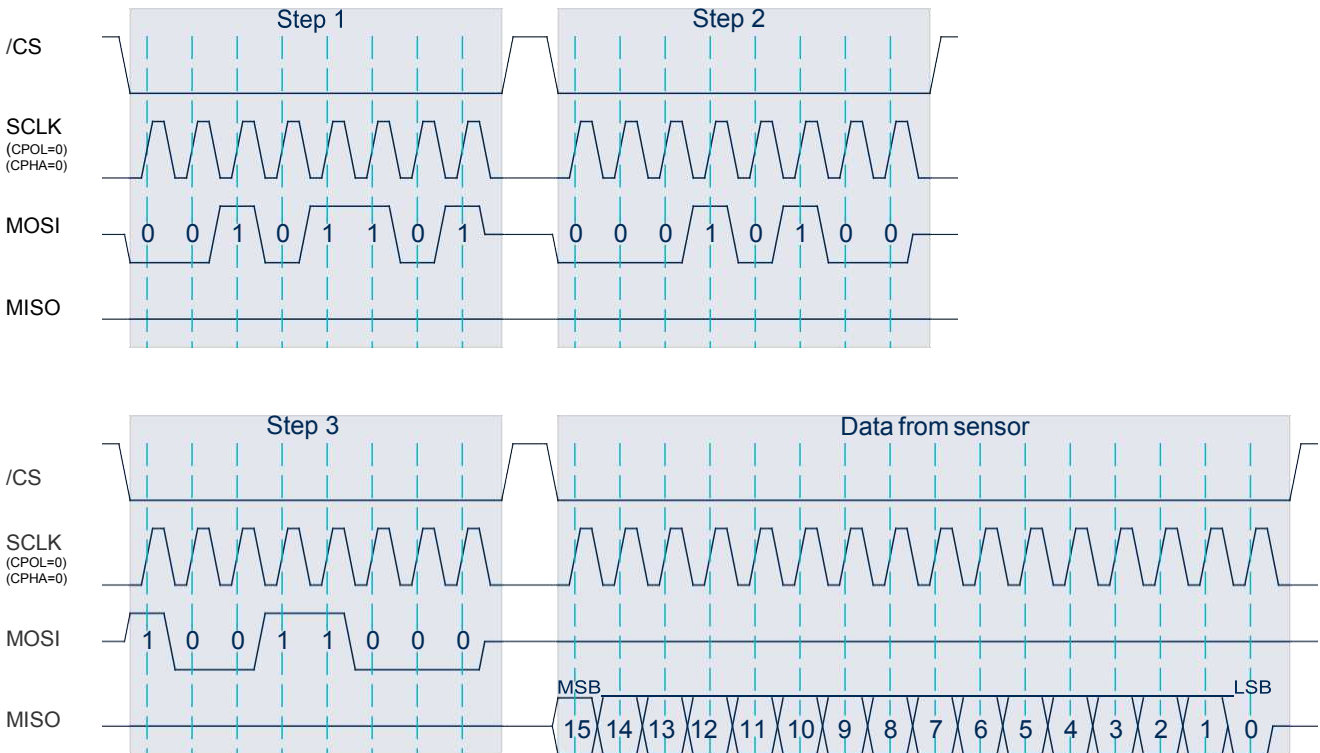

Fig. 5: SPI data transfer

SPI – Serial Peripheral Interface (cont.)

Data read – temperature

The on-chip temperature sensor changes 95 counts/°C over the operating range. The temperature data format is 15-bit plus sign in two's complement format. To read temperature, use the following sequence:

| Step | Hexadecimal | Binary | Description |
|------|-------------|-----------|--------------------------------------|
| 1 | 0x2A | B00101010 | Poll current temperature measurement |
| 2 | 0x14 | B00010100 | Send result to data register |
| 3 | 0x98 | B10011000 | Read data register |

From the digital sensor output, the actual temperature can be calculated as follows

$$\text{Temperature [}^{\circ}\text{C]} = \frac{\text{TS} - \text{TS}_0 \text{ [counts]}}{\text{Scalefactor}_{\text{TS}} \left[\frac{\text{counts}}{^{\circ}\text{C}} \right]} + T_0 \text{[}^{\circ}\text{C]}$$

where

TS is the actual sensor readout;

TS₀ is the sensor readout at known temperature T₀ ⁽¹⁵⁾;

Scale factor_{TS} = 95 counts/°C

LDE SERIES – DIGITAL LOW DIFFERENTIAL PRESSURE SENSORS

SPI – Serial Peripheral Interface (cont.)

Interface specification

| Parameter | Symbol | Conditions | Min. | Typ. | Max. | Unit | |
|---|-----------------|--|-------------------|------|-------------------|--------------|----|
| External clock frequency | f_{ECLK} | $V_{CKSEL}=0$ | Min. | | 0.2 | MHz | |
| | | | Max. | | 5 | | |
| External master clock input low time | $f_{ECLKIN LO}$ | $t_{ECLK}=1/f_{ECLK}$ | 40 | | 60 | $\%t_{ECLK}$ | |
| External master clock input high time | $f_{ECLKIN HI}$ | $t_{ECLK}=1/f_{ECLK}$ | 40 | | 60 | | |
| SCLK setup to falling edge /CS | t_{SC} | | 30 | | | ns | |
| /CS falling edge to SCLK rising edge setup time | t_{CSS} | | 30 | | | | |
| /CS idle time | t_{CSI} | $f_{CLK}=4$ MHz | 1.5 | | | μs | |
| SCLK falling edge to data valid delay | t_{DO} | $C_{LOAD}=15$ pF | | | 80 | ns | |
| Data valid to SCLK rising edge setup time | t_{DS} | | 30 | | | | |
| Data valid to SCLK rising edge hold time | t_{DH} | | 30 | | | | |
| SCLK high pulse width | t_{CH} | | 100 | | | | |
| SCLK low pulse width | t_{CL} | | 100 | | | | |
| /CS rising edge to SCLK rising edge hold time | t_{CSH} | | 30 | | | | |
| /CS falling edge to output enable | t_{DV} | $C_{LOAD}=15$ pF | | | 25 | | |
| /CS rising edge to output disable | t_{TR} | $C_{LOAD}=15$ pF | | | 25 | | |
| Lxxx6xxx (5 V supply) | | | | | | | |
| Maximum output load capacitance | C_{LOAD} | $R_{LOAD}=\infty$, phase margin $>55^\circ$ | | 200 | | | pF |
| Input voltage, logic HIGH | V_{IH} | | $0.8 \times V_S$ | | $V_S+0.3$ | | V |
| Input voltage, logic LOW | V_{IL} | | | | $0.2 \times V_S$ | | |
| Output voltage, logic HIGH | V_{OH} | $R_{LOAD}=\infty$ | $V_S-0.1$ | | | | |
| | | $R_{LOAD}=2$ k Ω | $V_S-0.15$ | | | | |
| Output voltage, logic LOW | V_{OL} | $R_{LOAD}=\infty$ | | | 0.5 | | |
| | | $R_{LOAD}=2$ k Ω | | | 0.2 | | |
| LDExxx3xxx (3 V supply) ⁽¹⁶⁾ | | | | | | | |
| Maximum output load capacitance | C_{LOAD} | $R_{LOAD}=1$ k Ω | | 15 | | pF | |
| Input voltage, logic HIGH | V_{IH} | | $0.65 \times V_S$ | | $V_S+0.3$ | V | |
| Input voltage, logic LOW | V_{IL} | | | | $0.35 \times V_S$ | | |
| Output voltage, logic HIGH | V_{OH} | $I_O=-20$ μA | $V_S-0.4$ | | | | |
| Output voltage, logic LOW | V_{OL} | $I_O=+20$ μA | | | 0.4 | | |

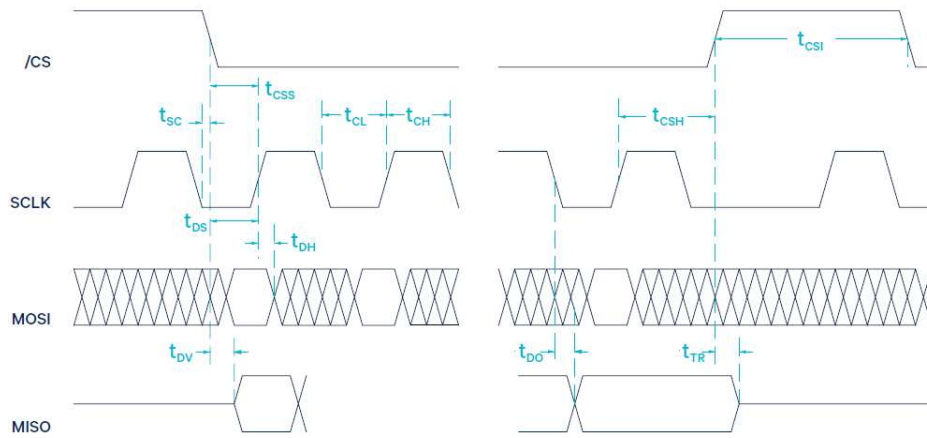
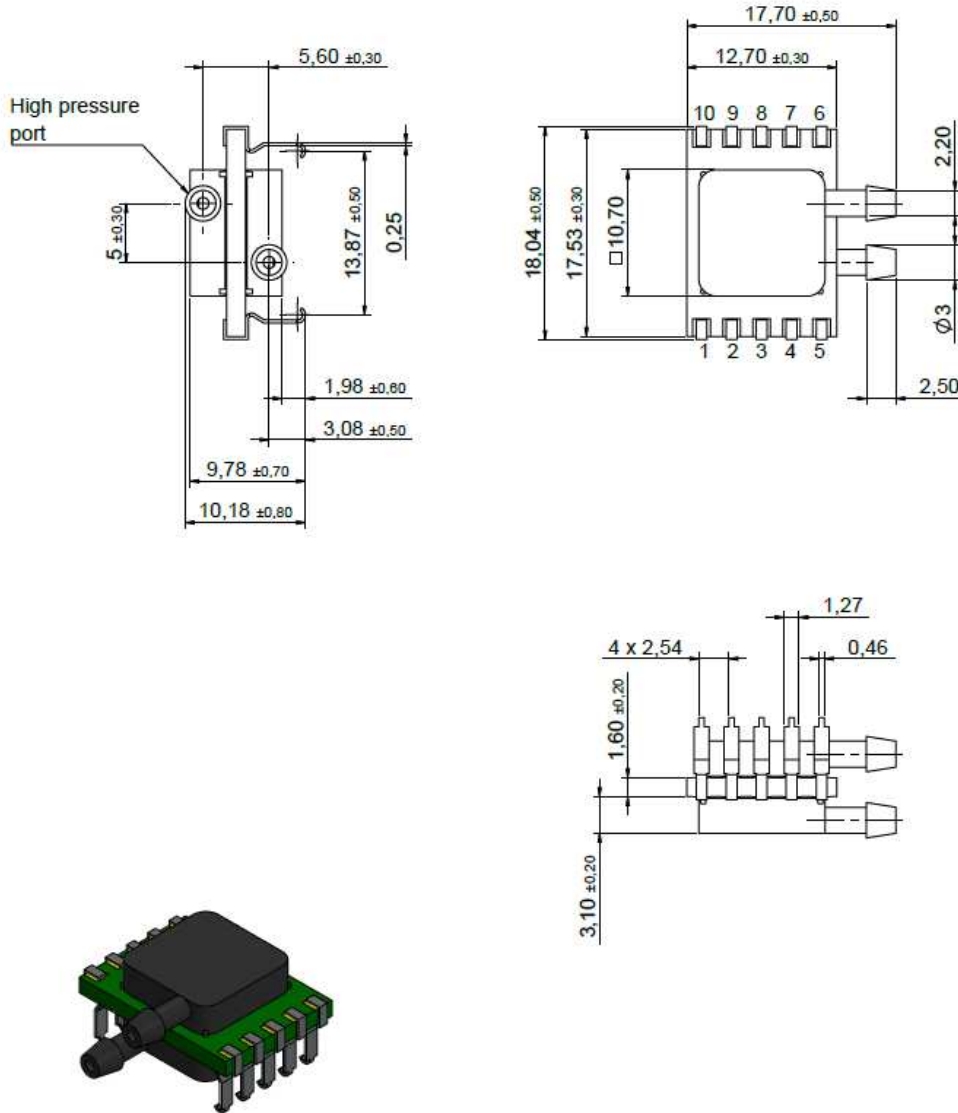

Fig. 6: SPI timing diagram

LDE SERIES – DIGITAL LOW DIFFERENTIAL PRESSURE SENSORS

Dimensional drawing

- LDExxxExxx (SMD, 2 ports same side)



all dimension in mm

all tolerances 0,10mm
unless otherwise noted

LDE SERIES – DIGITAL LOW DIFFERENTIAL PRESSURE SENSORS

Dimensional drawing

- LDExxxFxxx (DIP, 2 ports same side)

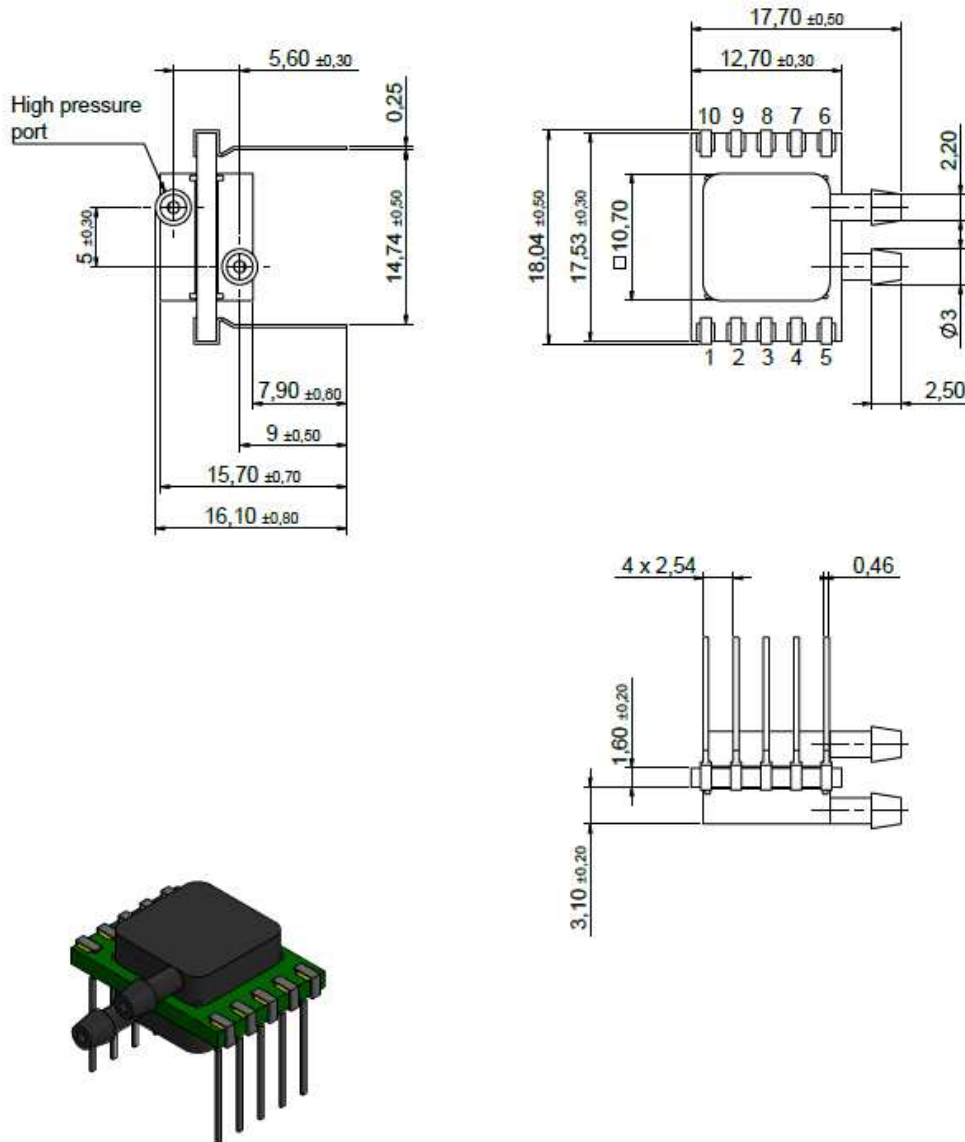

all dimension in mm
all tolerances 0,10mm
unless otherwise noted

LDE SERIES – DIGITAL LOW DIFFERENTIAL PRESSURE SENSORS

Recommended PCB footprint for LDExxxExxx

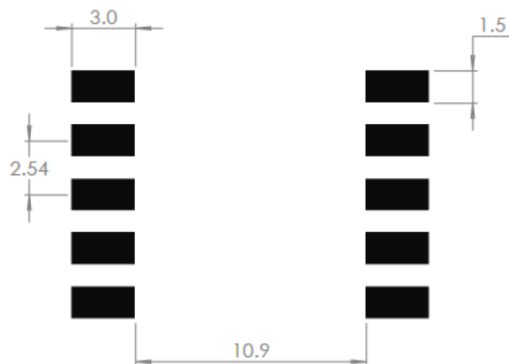

dimensions in mm measurements without tolerance are for reference only

Electrical connection ⁽¹⁷⁾

There are three use cases that will change the manner in which the LDE series device is connected in-circuit:

Case 1: Reading of pressure measurement as a digital (SPI) signal;

Case 2: Reading of pressure measurement as an analog (voltage) signal;

Case 3: Pin-to-pin compatible drop-in replacement for LBA series devices (5 V LDE devices only).

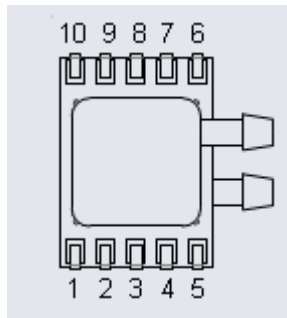

| Pin | Function | Case 1: Digital signal output | Case 2: Analog signal output | Case 3: LBA drop-in replacement (5 V only) |
|-----|----------------|-------------------------------------|---|---|
| 1 | Reserved | NC | NC | GND |
| 2 | V _s | +5V/+3V | +5V/+3V | +5V |
| 3 | GND | GND | GND | GND |
| 4 | Vout | NC | High impedance analog input (e.g. op- amp, ADC) | High impedance analog input (e.g. op-amp, ADC) |
| 5 | Vout | NC | | |
| 6 | SCLK | Master device SCLK | GND | GND |
| 7 | MOSI | Master device MOSI | GND | GND |
| 8 | MISO | Master device MISO | GND | GND |
| 9 | /CS | Master device (/CS) | V _s | GND |
| 10 | Reserved | NC | NC | GND |

LDE SERIES – DIGITAL LOW DIFFERENTIAL PRESSURE SENSORS

Part numbering key

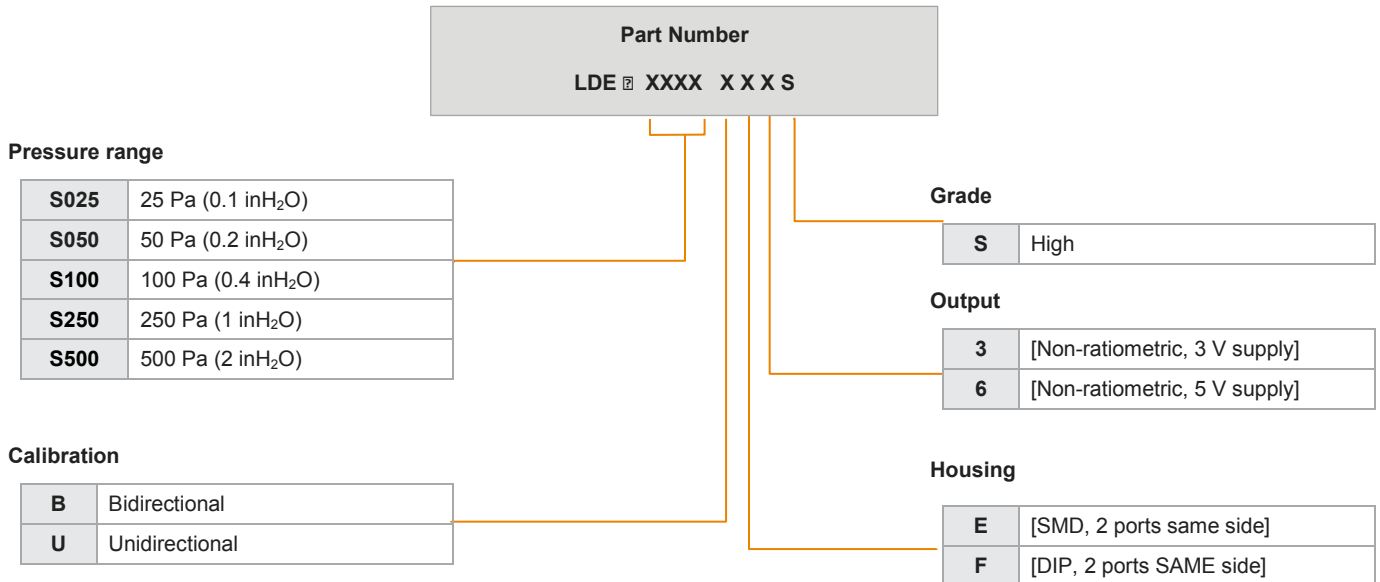

Order code example: LDES250BF6S

Ordering information (standard configurations)

| Description | TE Part Number | Pressure Range | Calibration | Housing | Output |
|-------------|----------------|-------------------|----------------|--------------------------|--------|
| LDES250UF6S | 1006941-F | 0 to 250 Pa | Unidirectional | [DIP, 2 ports SAME side] | 6V |
| LDES500UE3S | 5000659-F | 0 to 500 Pa | Unidirectional | [SMD, 2 ports same side] | 3V |
| LDES100UF6S | 1006939-F | 0 to 100 Pa | Unidirectional | [DIP, 2 ports SAME side] | 6V |
| LDES500BF6S | 5000658-F | -500 Pa to 500 Pa | Bidirectional | [DIP, 2 ports SAME side] | 6V |
| LDES250UE3S | 5000652-F | 0 to 250 Pa | Unidirectional | [SMD, 2 ports same side] | 3V |
| LDES500UF6S | 1006943-F | 0 to 500 Pa | Unidirectional | [DIP, 2 ports SAME side] | 6V |
| LDES300UE3S | 5000655-F | 0 to 300 Pa | Unidirectional | [SMD, 2 ports same side] | 3V |