



LDE SERIES – DIGITAL LOW DIFFERENTIAL PRESSURE SENSORS

The LDE differential low-pressure sensors are based on thermal flow measurement of gas through a micro-flow channel integrated within the sensor chip. The innovative LDE technology features superior sensitivity especially for ultra-low pressures. The extremely low gas flow through the sensor ensures high immunity to dust contamination, humidity and long tubing compared to other flow-based pressure sensors.

Features

- Ultra-low-pressure ranges from 25 to 500 Pa (0.1 to 2 inH₂O)
- Pressure sensor based on thermal micro-flow measurement
- High flow impedance
- very low flow-through leakage
- high immunity to dust and humidity
- no loss in sensitivity using long tubing
- Calibrated and temperature compensated
- Unique offset autozeroing feature ensuring superb long-term stability
- Offset accuracy better than 0.2% FS
- Total accuracy better than 0.5% FS typical
- On-chip temperature sensor
- Analog output and digital SPI interface
- No position sensitivity

Certificates

- Quality Management System according to EN ISO 13485 and EN ISO 9001
- RoHS and REACH compliant

Media compatibility

Air and other non-corrosive gases

Applications

Medical

- Ventilators
- Spirometers
- CPAP
- Sleep diagnostic equipment
- Nebulizers
- Oxygen conservers/concentrators
- Insufflators/endoscopy

Industrial

- HVAC
- VAV
- Filter monitoring
- Burner control
- Fuel cells
- Gas leak detection
- Gas metering
- Fume hood
- Instrumentation
- Security systems

CLICK HERE ›
CONNECT WITH A SPECIALIST

LDE SERIES – DIGITAL LOW DIFFERENTIAL PRESSURE SENSORS

Maximum ratings

Parameter		Min.	Max.	Unit
Supply voltage V_s	LDExxx3xxx	2.70	3.60	V_{DC}
	LDExxx6xxx	4.75	5.25	
Output current			1	mA
Soldering recommendation				
Reflow soldering ^(1,2)				
Average preheating temperature gradient			1.5	K/s
Time above 217 °C			74	s
Time above 240 °C			30	
Peak temperature			245	°C
Cooling temperature gradient			-1.4	K/s
Wave soldering, pot temperature			260	°C
Hand soldering, tip temperature			370	
Temperature ranges				
Compensated		0	+70	°C
Operating		-20	+80	
Storage		-40	+80	
Humidity limits (nin-condensing)			97	%RH
Vibration ⁽³⁾			20	g
Mechanical shock ⁽⁴⁾			500	

Pressure sensor characteristics

Part no.	Operating pressure	Proof pressure ⁽⁵⁾	Burst pressure ⁽⁵⁾
LDES025Uxxx	0 to 25 Pa / 0 to 0.25 mbar (0.1 inH2O)	2 bar (30 psi)	5 bar (75 psi)
LDES050Uxxx	0 to 50 Pa / 0 to 0.5 mbar (0.2 inH2O)		
LDES100Uxxx	0 to 100 Pa / 0 to 1 mbar (0.4 inH2O)		
LDES250Uxxx	0 to 250 Pa / 0 to 2.5 mbar (1 inH2O)		
LDES500Uxxx	0 to 500 Pa / 0 to 5 mbar (2 inH2O)		
LDES025Bxxx	0 to ±25 Pa / 0 to ±0.25 mbar (±0.1 inH2O)		
LDES050Bxxx	0 to ±50 Pa / 0 to ±0.5 mbar (±0.2 inH2O)		
LDES100Bxxx	0 to ±100 Pa / 0 to ±1 mbar (±0.4 inH2O)		
LDES250Bxxx	0 to ±250 Pa / 0 to ±2.5 mbar (±1 inH2O)		
LDES500Bxxx	0 to ±500 Pa / 0 to ±5 mbar (±2 inH2O)		

Gas correction factors ⁽⁶⁾

Gas type	Correction factor
Dry air	1.0
Oxygen (O ₂)	1.07
Nitrogen (N ₂)	0.97
Argon (Ar)	0.98
Carbon dioxide (CO ₂)	0.56

LDE SERIES – DIGITAL LOW DIFFERENTIAL PRESSURE SENSORS

LDExxx6xxx Performance characteristics ⁽⁷⁾

(V_S=5.0 V_{DC}, T_A=20 °C, P_{Abs}=1 bara, calibrated in air, analog and digital output signals are non-ratiometric to V_S)

25 Pa and 50 Pa devices

Parameter	Min.	Typ.	Max.	Unit
Noise level (RMS)		±0.01		Pa
Offset warm-up shift			less than noise	
Offset long term stability ⁽⁸⁾		±0.05	±0.1	Pa/year
Offset repeatability		±0.01		Pa
Span repeatability ^(11,12)		±0.25		% of reading
Current consumption (no load) ⁽⁹⁾		7	8	mA
Response time (t ₆₃)		5		ms
Power-on time			25	ms

Digital output

Parameter	Min.	Typ.	Max.	Unit	
Scale factor (digital output) ⁽¹⁰⁾	0 to 25/0 to ±25 Pa	1200		counts/Pa	
	0 to 50/0 to ±50 Pa	600		counts/Pa	
Zero pressure offset accuracy ⁽¹¹⁾		±0.1	±0.2	%FSS	
Span accuracy ^(11,12)		±0.4	±0.75	% of reading	
Thermal effects	Offset	5 to 55 °C		±0.2	%FSS
		0 to 70 °C		±0.4	%FSS
	Span	5 to 55 °C	±1	±1.75	% of reading
		0 to 70 °C	±2	±2.75	% of reading

Analog output (unidirectional devices)

Parameter	Min.	Typ.	Max.	Unit	
Zero pressure offset ⁽¹¹⁾	0.49	0.50	0.51	V	
Full scale output		4.50		V	
Span accuracy ^(11,12)		±0.4	±0.75	% of reading	
Thermal effects	Offset	5 to 55 °C		±15	mV
		0 to 70 °C		±30	mV
	Span	5 to 55 °C	±1.25	±2	% of reading
		0 to 70 °C	±2	±2.75	% of reading

LDE SERIES – DIGITAL LOW DIFFERENTIAL PRESSURE SENSORS

Analog output (bidirectional devices)

Parameter		Min.	Typ.	Max.	Unit	
Zero pressure offset ⁽¹¹⁾		2.49	2.50	2.51	V	
Output	at max. specified pressure		4.50		V	
	at min. specified pressure		0.50		V	
Span accuracy ^(11,12)			±0.4	±0.75	% of reading	
Thermal effects	Offset	5 to 55 °C			±15	mV
		0 to 70 °C			±30	mV
	Span	5 to 55 °C		±1.25	±2	% of reading
		0 to 70 °C		±2	±2.75	% of reading

LDExxx6xxx Performance characteristics (cont.)⁽⁷⁾

(V_S=5.0 V_{DC}, T_A=20 °C, P_{Abs}=1 bara, calibrated in air, analog and digital output signals are non-ratiometric to V_S)

100 Pa, 250 Pa and 500 Pa devices

Parameter	Min.	Typ.	Max.	Unit
Noise level (RMS)		±0.01		%FSS
Offset warm-up shift			less than noise	
Offset long term stability ⁽⁸⁾		±0.05	±0.1	%FSS/year
Offset repeatability ⁽¹³⁾		±0.02		Pa
Span repeatability ^(11,12)		±0.25		% of reading
Current consumption (no load) ⁽⁹⁾		7	8	mA
Response time (t ₆₃)		5		ms
Power-on time			25	ms

Digital output

Parameter		Min.	Typ.	Max.	Unit	
Scale factor (digital output) ⁽¹⁰⁾	0 to 100/0 to ±100 Pa		300		counts/Pa	
	0 to 250/0 to ±250 Pa		120			
	0 to 500/0 to ±500 Pa		60			
Zero pressure offset accuracy ⁽¹¹⁾			±0.05	±0.1	%FSS	
Span accuracy ^(11,12)			±0.4	±0.75	% of reading	
Thermal effects	Offset	5 to 55 °C			±0.1	%FSS
		0 to 70 °C			±0.2	%FSS
	Span	5 to 55 °C		±1	±1.75	% of reading
		0 to 70 °C		±2	±2.75	% of reading

Analog output (unidirectional devices)

Parameter		Min.	Typ.	Max.	Unit	
Zero pressure offset ⁽¹¹⁾		0.49	0.50	0.51	V	
Full scale output			4.50		V	
Span accuracy ^(11,12)			±0.4	±0.75	% of reading	
Thermal effects	Offset	5 to 55 °C			±10	mV
		0 to 70 °C			±12	mV
	Span	5 to 55 °C		±1	±1.75	% of reading
		0 to 70 °C		±2	±2.75	% of reading

LDE SERIES – DIGITAL LOW DIFFERENTIAL PRESSURE SENSORS

Analog output (bidirectional devices)

Parameter		Min.	Typ.	Max.	Unit	
Zero pressure offset ⁽¹¹⁾		2.49	2.50	2.51	V	
Output	at max. specified pressure		4.50		V	
	at min. specified pressure		0.50		V	
Span accuracy ^(11,12)			±0.4	±0.75	% of reading	
Thermal effects	Offset	5 to 55 °C		±10	mV	
		0 to 70 °C		±12	mV	
	Span	5 to 55 °C		±1	±1.75	% of reading
		0 to 70 °C		±2	±2.75	% of reading

LDExxx3xxx Performance characteristics ⁽⁷⁾

(V_S=3.0 V_{DC}, T_A=20 °C, P_{Abs}=1 bara, calibrated in air, analog and digital output signals are non-ratiometric to V_S)

25 Pa and 50 Pa devices

Parameter	Min.	Typ.	Max.	Unit
Noise level (RMS)		±0.01		Pa
Offset warm-up shift			less than noise	
Offset long term stability ⁽⁸⁾		±0.05	±0.1	Pa/year
Offset repeatability		±0.01		Pa
Span repeatability ^(11,12)		±0.25		% of reading
Current consumption (no load) ⁽⁹⁾		14	16	mA
Response time (t ₆₃)		5		ms
Power-on time			25	ms

Digital output

Parameter		Min.	Typ.	Max.	Unit	
Scale factor (digital output) ⁽¹⁰⁾	0 to 25/0 to ±25 Pa		1200		counts/Pa	
	0 to 50/0 to ±50 Pa		600		counts/Pa	
Zero pressure offset accuracy ⁽¹¹⁾			±0.1	±0.2	%FSS	
Span accuracy ^(11,12)			±0.4	±0.75	% of reading	
Thermal effects	Offset	5 to 55 °C		±0.2	%FSS	
		0 to 70 °C		±0.4	%FSS	
	Span	5 to 55 °C		±1	±1.75	% of reading
		0 to 70 °C		±2	±2.75	% of reading

LDE SERIES – DIGITAL LOW DIFFERENTIAL PRESSURE SENSORS

Analog output (unidirectional devices)

Parameter			Min.	Typ.	Max.	Unit
Zero pressure offset ⁽¹¹⁾			0.29	0.30	0.31	V
Full scale output				2.70		V
Span accuracy ^(11,12)				±0.4	±0.75	% of reading
Thermal effects	Offset	5 to 55 °C			±15	mV
		0 to 70 °C			±30	mV
	Span	5 to 55 °C		±1.25	±2	% of reading
		0 to 70 °C		±2	±2.75	% of reading

Analog output (bidirectional devices)

Parameter			Min.	Typ.	Max.	Unit
Zero pressure offset ⁽¹¹⁾			1.49	1.50	1.51	V
Output	at max. specified pressure			2.70		V
	at min. specified pressure			0.30		V
Span accuracy ^(11,12)				±0.4	±0.75	% of reading
Thermal effects	Offset	5 to 55 °C			±15	mV
		0 to 70 °C			±30	mV
	Span	5 to 55 °C		±1.25	±2	% of reading
		0 to 70 °C		±2	±2.75	% of reading

LDExxx3xxx Performance characteristics (cont.) ⁽⁷⁾

(V_S=3.0 V_{DC}, T_A=20 °C, P_{Abs}=1 bara, calibrated in air, analog and digital output signals are non-ratiometric to V_S)

100 Pa, 250 Pa and 500 Pa devices

Parameter	Min.	Typ.	Max.	Unit
Noise level (RMS)		±0.01		%FSS
Offset warm-up shift			less than noise	
Offset long term stability ⁽⁸⁾		±0.05	±0.1	%FSS/year
Offset repeatability ⁽¹³⁾		±0.02		Pa
Span repeatability ^(11,12)		±0.25		% of reading
Current consumption (no load) ⁽⁹⁾		14	16	mA
Response time (t ₆₃)		5		ms
Power-on time			25	ms

LDE SERIES – DIGITAL LOW DIFFERENTIAL PRESSURE SENSORS

Digital output

Parameter		Min.	Typ.	Max.	Unit	
Scale factor (digital output) ⁽¹⁰⁾	0 to 100/0 to ±100 Pa		300		counts/Pa	
	0 to 250/0 to ±250 Pa		120			
	0 to 500/0 to ±500 Pa		60			
Zero pressure offset accuracy ⁽¹¹⁾			±0.05	±0.1	%FSS	
Span accuracy ^(11,12)			±0.4	±0.75	% of reading	
Thermal effects	Offset	5 to 55 °C			±0.1	%FSS
		0 to 70 °C			±0.2	%FSS
	Span	5 to 55 °C		±1	±1.75	% of reading
		0 to 70 °C		±2	±2.75	% of reading

Analog output (unidirectional devices)

Parameter		Min.	Typ.	Max.	Unit	
Zero pressure offset ⁽¹¹⁾		0.29	0.30	0.31	V	
Full scale output			2.70		V	
Span accuracy ^(11,12)			±0.4	±0.75	% of reading	
Thermal effects	Offset	5 to 55 °C			±10	mV
		0 to 70 °C			±12	mV
	Span	5 to 55 °C		±1	±1.75	% of reading
		0 to 70 °C		±2	±2.75	% of reading

Analog output (bidirectional devices)

Parameter		Min.	Typ.	Max.	Unit	
Zero pressure offset ⁽¹¹⁾		1.49	1.50	1.51	V	
Output	at max. specified pressure		2.70		V	
	at min. specified pressure		0.30		V	
Span accuracy ^(11,12)			±0.4	±0.75	% of reading	
Thermal effects	Offset	5 to 55 °C			±10	mV
		0 to 70 °C			±12	mV
	Span	5 to 55 °C		±1	±1.75	% of reading
		0 to 70 °C		±2	±2.75	% of reading

Performance characteristics

Temperature sensor

Parameter	Min.	Typ.	Max.	Unit
Scale factor (digital output)		95		counts/°C
Non-linearity		±0.5		%FS
Hysteresis		±0.1		%FS

Total accuracy ⁽¹⁴⁾

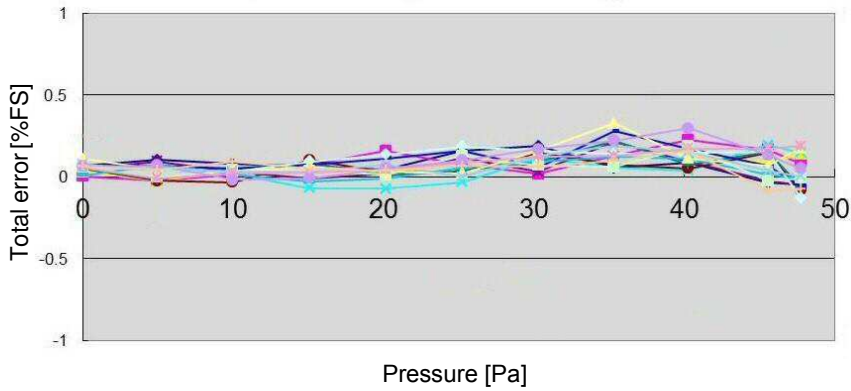

Fig. 1: Typical total accuracy plot of 16 LDE 50 Pa sensors @ 25 °C (typical total accuracy better than 0.5 %FS)

Offset long term stability

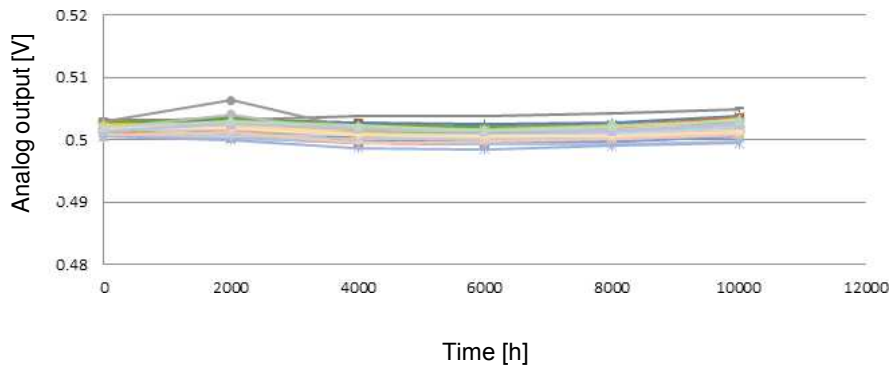

Fig. 2: Offset long term stability for LDE 250 Pa sensors after 10,000 hours @ 85°C powered, equivalent to over 43.5 years @ 25 °C (better than ± 2 mV / ± 0.125 Pa)

SPI – Serial Peripheral Interface

Note: it is important to adhere to the communication protocol in order to avoid damage to the sensor.

Introduction

The LDE serial interface is a high-speed synchronous data input and output communication port. The serial interface operates using a standard 4-wire SPI bus. The LDE device runs in SPI mode 0, which requires the clock line SCLK to idle low (CPOL = 0), and for data to be sampled on the leading clock edge (CPHA = 0). Figure 5 illustrates this mode of operation.

Care should be taken to ensure that the sensor is properly connected to the master microcontroller. Refer to the manufacturer's datasheet for more information regarding physical connections.

Application circuit

The use of pull-up resistors is generally unnecessary for SPI as most master devices are configured for push-pull mode. If pull-up resistors are required for use with 3 V LDE devices, however, they should be greater than 50 kΩ.

There are, however, some cases where it may be helpful to use 33Ω series resistors at both ends of the SPI lines, as shown in Figure 3.

Signal quality may be further improved by the addition of a buffer as shown in Figure 4. These cases include multiple slave devices on the same bus segment, using a master device with limited driving capability and long SPI bus lines.

If these series resistors are used, they must be physically placed as close as possible to the pins of the master and slave devices.

Signal control

The serial interface is enabled by asserting /CS low. The serial input clock, SCLK, is gated internally to begin accepting the input data at MOSI or sending the output data on MISO. When /CS rises, the data clocked into MOSI is loaded into an internal register.

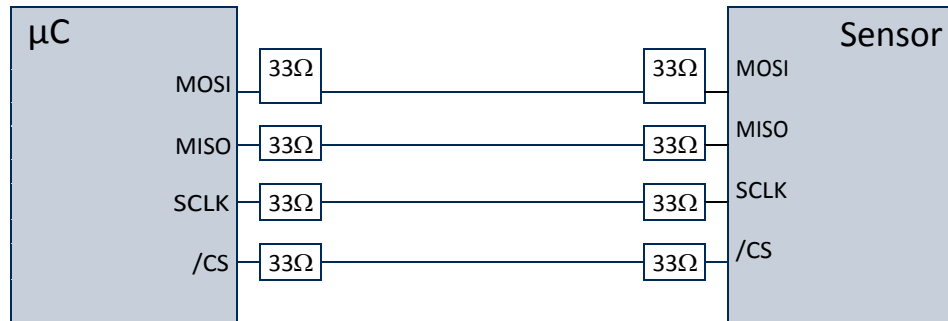

Fig. 3: Application circuit with resistors at both ends of the SPI lines

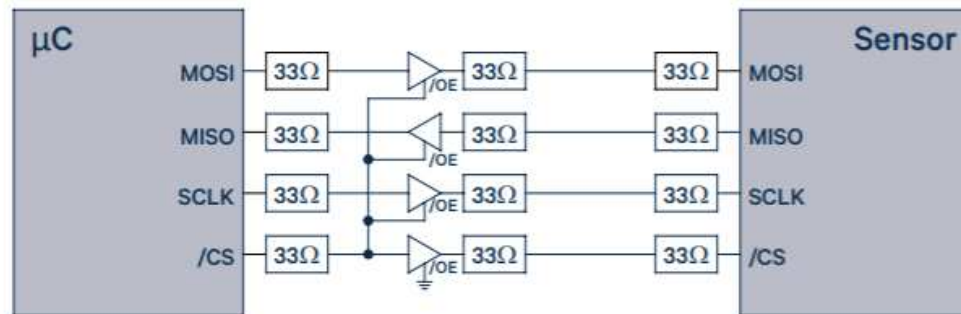

Fig. 4: Application circuit with additional buffer

SPI – Serial Peripheral Interface (cont.)

Note: it is important to adhere to the communication protocol in order to avoid damage to the sensor.

Data read – pressure

When powered on, the sensor begins to continuously measure pressure. To initiate data transfer from the sensor, the following three unique bytes must be written sequentially, MSB first, to the MOSI pin (see Figure 5):

Step	Hexadecimal	Binary	Description
1	0x2D	B00101101	Poll current pressure measurement
2	0x14	B00010100	Send result to data register
3	0x98	B10011000	Read data register

The entire 16 bit content of the LDE register is then read out on the MISO pin, MSB first, by applying 16 successive clock pulses to SCLK with /CS asserted low. Note that the value of the LSB is held at zero for internal signal processing purposes. This is below the noise threshold of the sensor and thus its fixed value does not affect sensor performance and accuracy.

From the digital sensor output the actual pressure value can be calculated as follows:

$$\text{Pressure [Pa]} = \frac{\text{Digital output [counts]}}{\text{Scale factor} \left[\frac{\text{counts}}{\text{Pa}} \right]}$$

For example, for a ±250 Pa sensor (LDES250Bxxx) with a scale factor of 120 a digital output of 30 000 counts (7530'h) calculates to a positive pressure of 250 Pa. Similarly, a digital output of -30 000 counts (8AD0'h) calculates to a negative pressure of -250 Pa.

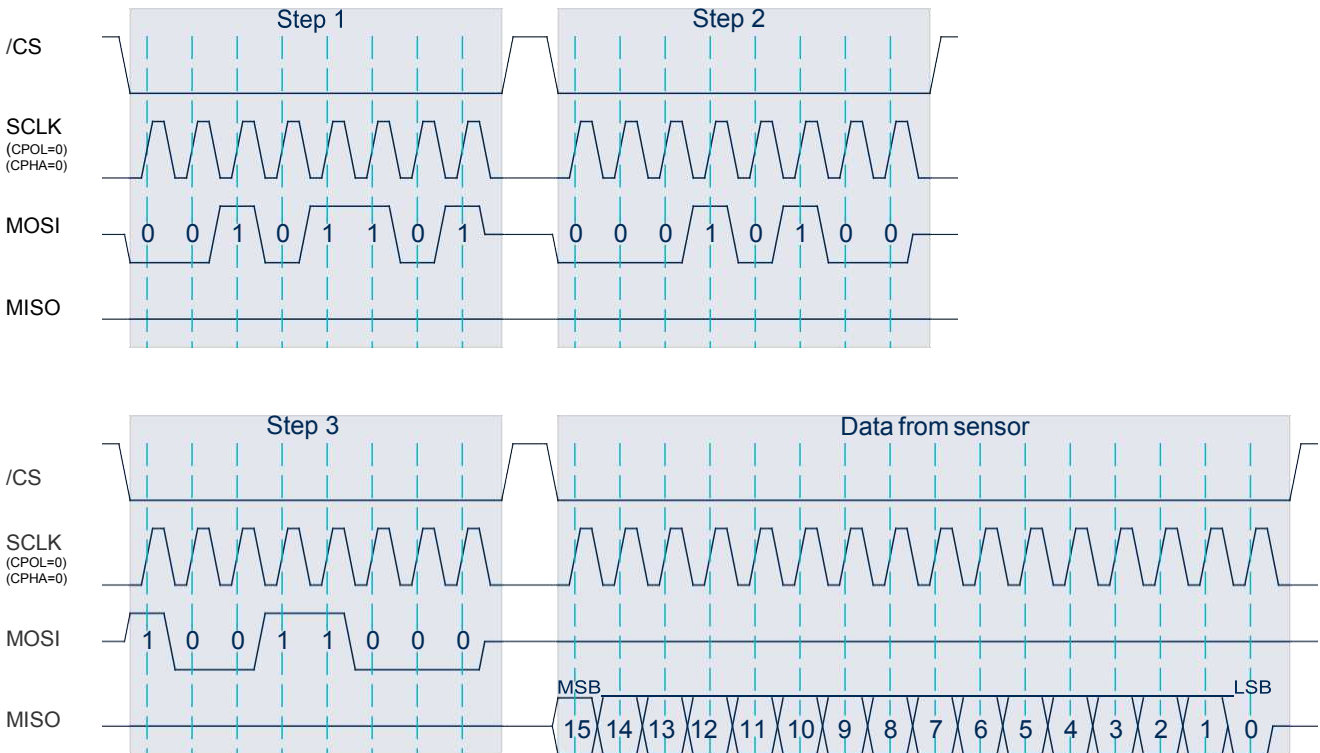

Fig. 5: SPI data transfer

SPI – Serial Peripheral Interface (cont.)

Data read – temperature

The on-chip temperature sensor changes 95 counts/°C over the operating range. The temperature data format is 15-bit plus sign in two's complement format. To read temperature, use the following sequence:

Step	Hexadecimal	Binary	Description
1	0x2A	B00101010	Poll current temperature measurement
2	0x14	B00010100	Send result to data register
3	0x98	B10011000	Read data register

From the digital sensor output, the actual temperature can be calculated as follows

$$\text{Temperature [}^{\circ}\text{C]} = \frac{\text{TS} - \text{TS}_0 \text{ [counts]}}{\text{Scalefactor}_{\text{TS}} \left[\frac{\text{counts}}{^{\circ}\text{C}} \right]} + \text{T}_0 \text{[}^{\circ}\text{C]}$$

where

TS is the actual sensor readout;

TS₀ is the sensor readout at known temperature T₀⁽¹⁵⁾;

Scale factor_{TS} = 95 counts/°C

LDE SERIES – DIGITAL LOW DIFFERENTIAL PRESSURE SENSORS

SPI – Serial Peripheral Interface (cont.)

Interface specification

Parameter	Symbol	Conditions	Min.	Typ.	Max.	Unit	
External clock frequency	f_{ECLK}	$V_{CKSEL}=0$	Min.		0.2	MHz	
			Max.		5		
External master clock input low time	$f_{ECLKIN LO}$	$t_{ECLK}=1/f_{ECLK}$	40		60	$\%t_{ECLK}$	
External master clock input high time	$f_{ECLKIN HI}$	$t_{ECLK}=1/f_{ECLK}$	40		60		
SCLK setup to falling edge /CS	t_{SC}		30			ns	
/CS falling edge to SCLK rising edge setup time	t_{CSS}		30				
/CS idle time	t_{CSI}	$f_{CLK}=4$ MHz	1.5			μs	
SCLK falling edge to data valid delay	t_{DO}	$C_{LOAD}=15$ pF			80	ns	
Data valid to SCLK rising edge setup time	t_{DS}		30				
Data valid to SCLK rising edge hold time	t_{DH}		30				
SCLK high pulse width	t_{CH}		100				
SCLK low pulse width	t_{CL}		100				
/CS rising edge to SCLK rising edge hold time	t_{CSH}		30				
/CS falling edge to output enable	t_{DV}	$C_{LOAD}=15$ pF			25		
/CS rising edge to output disable	t_{TR}	$C_{LOAD}=15$ pF			25		
Lxxx6xxx (5 V supply)							
Maximum output load capacitance	C_{LOAD}	$R_{LOAD}=\infty$, phase margin $>55^\circ$		200			pF
Input voltage, logic HIGH	V_{IH}		$0.8 \times V_S$		$V_S+0.3$		V
Input voltage, logic LOW	V_{IL}				$0.2 \times V_S$		
Output voltage, logic HIGH	V_{OH}	$R_{LOAD}=\infty$	$V_S-0.1$				
		$R_{LOAD}=2$ k Ω	$V_S-0.15$				
Output voltage, logic LOW	V_{OL}	$R_{LOAD}=\infty$			0.5		
		$R_{LOAD}=2$ k Ω			0.2		
LDExxx3xxx (3 V supply) ⁽¹⁶⁾							
Maximum output load capacitance	C_{LOAD}	$R_{LOAD}=1$ k Ω		15		pF	
Input voltage, logic HIGH	V_{IH}		$0.65 \times V_S$		$V_S+0.3$	V	
Input voltage, logic LOW	V_{IL}				$0.35 \times V_S$		
Output voltage, logic HIGH	V_{OH}	$I_O=-20$ μA	$V_S-0.4$				
Output voltage, logic LOW	V_{OL}	$I_O=+20$ μA			0.4		

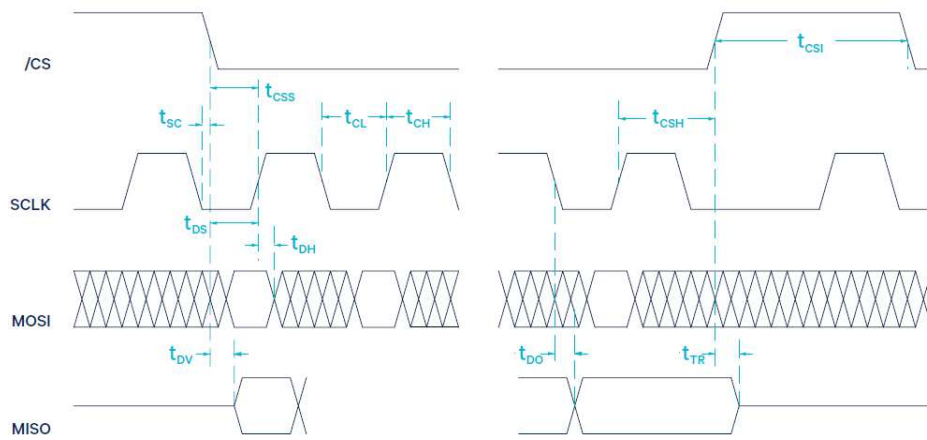
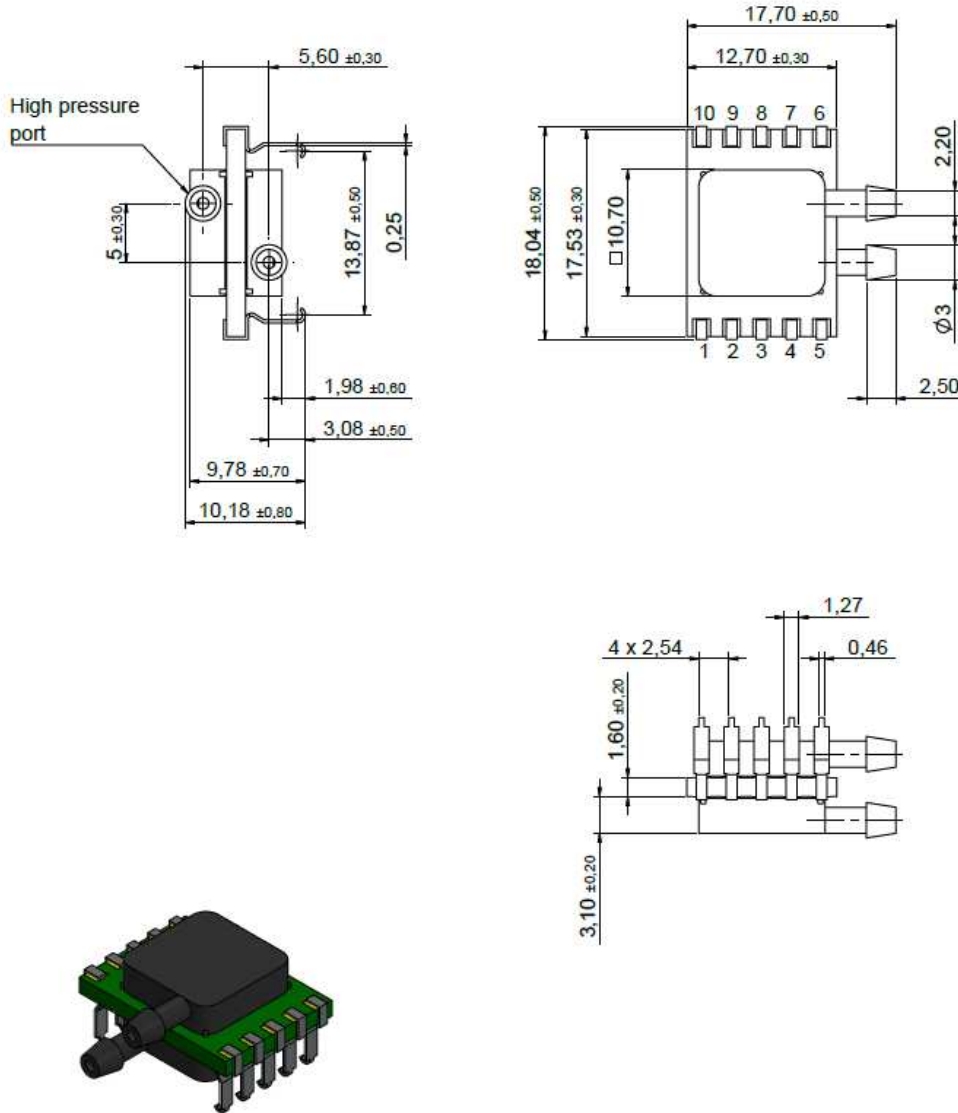

Fig. 6: SPI timing diagram

LDE SERIES – DIGITAL LOW DIFFERENTIAL PRESSURE SENSORS

Dimensional drawing

- LDExxxExxx (SMD, 2 ports same side)



all dimension in mm

all tolerances 0,10mm
unless otherwise noted

LDE SERIES – DIGITAL LOW DIFFERENTIAL PRESSURE SENSORS

Dimensional drawing

- LDExxxFxxx (DIP, 2 ports same side)

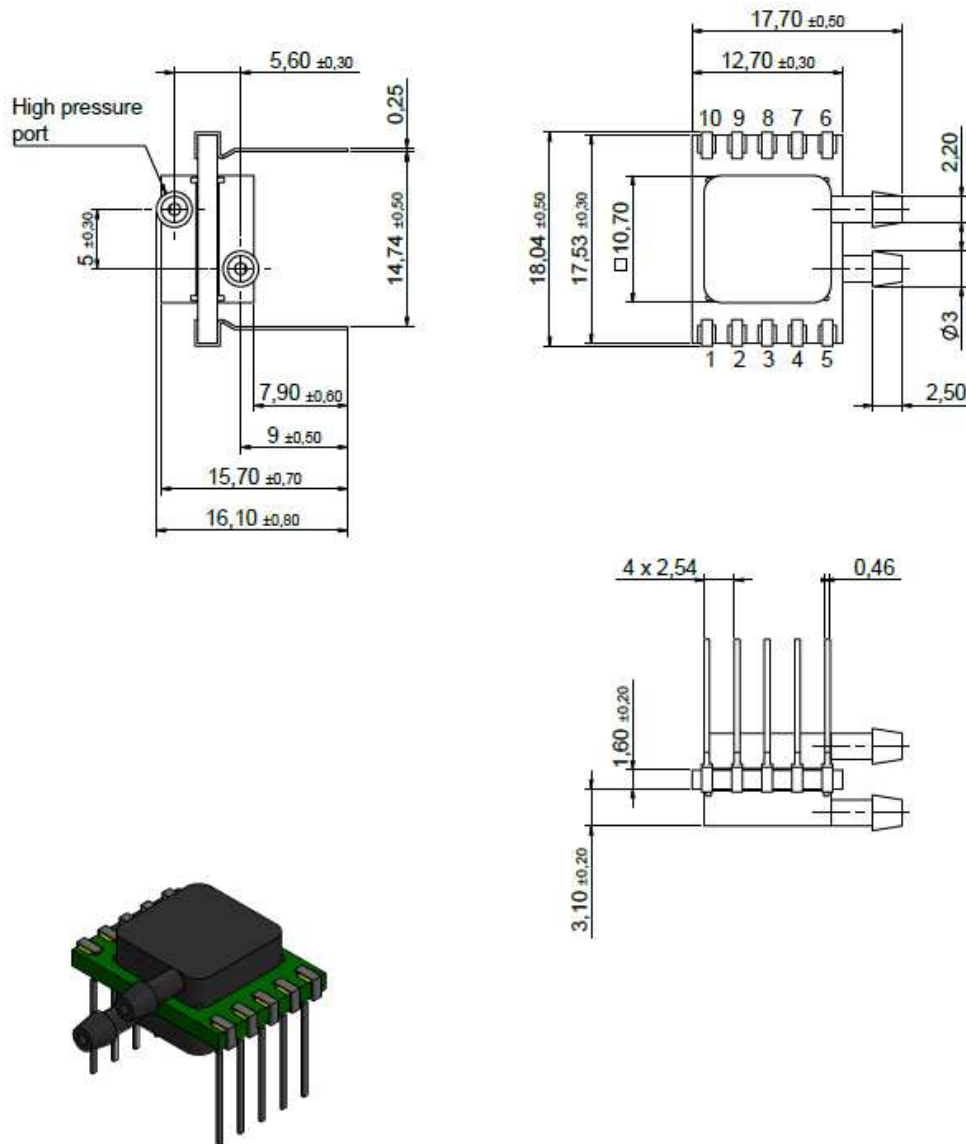

all dimension in mm
all tolerances 0,10mm
unless otherwise noted

LDE SERIES – DIGITAL LOW DIFFERENTIAL PRESSURE SENSORS

Recommended PCB footprint for LDExxxExxx

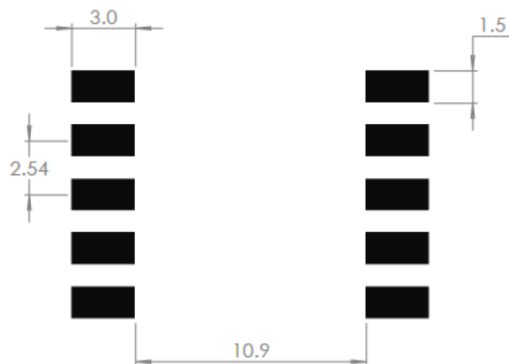

dimensions in mm measurements without tolerance are for reference only

Electrical connection ⁽¹⁷⁾

There are three use cases that will change the manner in which the LDE series device is connected in-circuit:

Case 1: Reading of pressure measurement as a digital (SPI) signal;

Case 2: Reading of pressure measurement as an analog (voltage) signal;

Case 3: Pin-to-pin compatible drop-in replacement for LBA series devices (5 V LDE devices only).

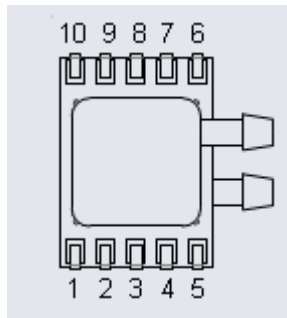

Pin	Function	Case 1: Digital signal output	Case 2: Analog signal output	Case 3: LBA drop-in replacement (5 V only)
1	Reserved	NC	NC	GND
2	V _s	+5V/+3V	+5V/+3V	+5V
3	GND	GND	GND	GND
4	Vout	NC	High impedance analog input (e.g. op- amp, ADC)	High impedance analog input (e.g. op-amp, ADC)
5	Vout	NC		
6	SCLK	Master device SCLK	GND	GND
7	MOSI	Master device MOSI	GND	GND
8	MISO	Master device MISO	GND	GND
9	/CS	Master device (/CS)	V _s	GND
10	Reserved	NC	NC	GND

LDE SERIES – DIGITAL LOW DIFFERENTIAL PRESSURE SENSORS

Part numbering key

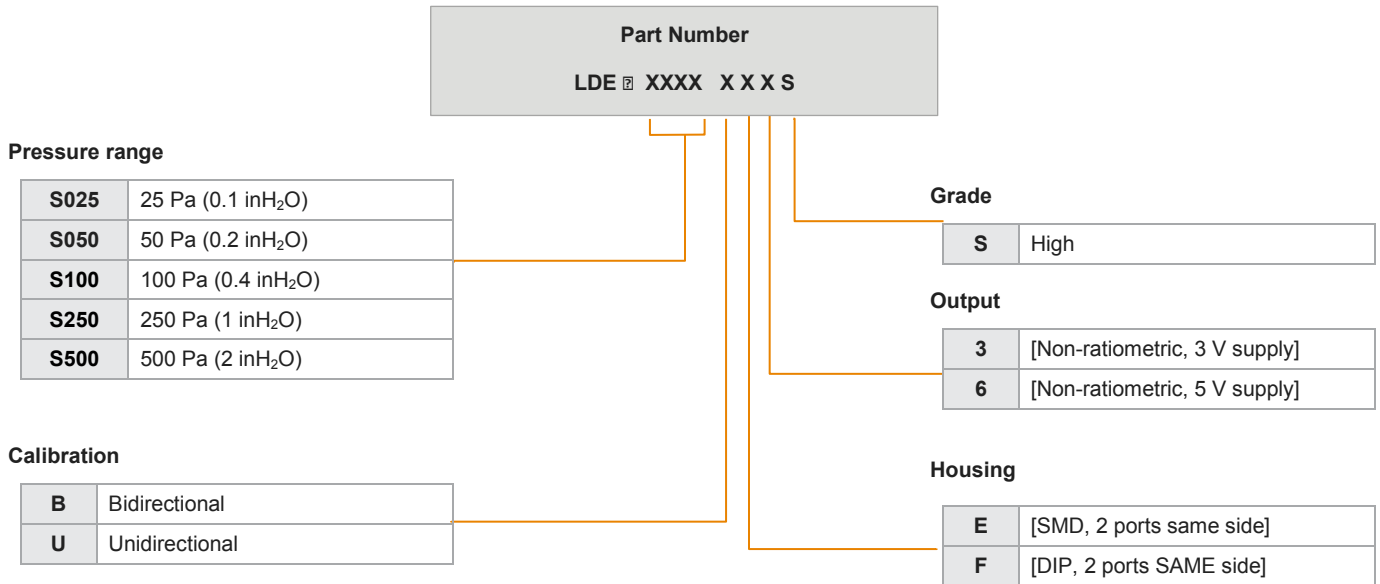

Order code example: LDES250BF6S

Ordering information (standard configurations)

Description	TE Part Number	Pressure Range	Calibration	Housing	Output
LDES250UF6S	1006941-F	0 to 250 Pa	Unidirectional	[DIP, 2 ports SAME side]	6V
LDES500UE3S	5000659-F	0 to 500 Pa	Unidirectional	[SMD, 2 ports same side]	3V
LDES100UF6S	1006939-F	0 to 100 Pa	Unidirectional	[DIP, 2 ports SAME side]	6V
LDES500BF6S	5000658-F	-500 Pa to 500 Pa	Bidirectional	[DIP, 2 ports SAME side]	6V
LDES250UE3S	5000652-F	0 to 250 Pa	Unidirectional	[SMD, 2 ports same side]	3V
LDES500UF6S	1006943-F	0 to 500 Pa	Unidirectional	[DIP, 2 ports SAME side]	6V
LDES300UE3S	5000655-F	0 to 300 Pa	Unidirectional	[SMD, 2 ports same side]	3V