

LDE series – digital low differential pressure sensors

The LDE differential low pressure sensors are based on thermal flow measurement of gas through a micro-flow channel integrated within the sensor chip. The innovative LDE technology features superior sensitivity especially for ultra low pressures. The extremely low gas flow through the sensor ensures high immunity to dust contamination, humidity and long tubing compared to other flow-based pressure sensors.

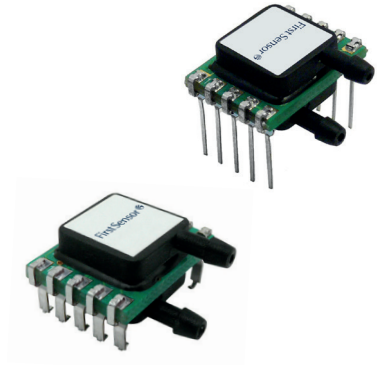

Features

- Ultra-low pressure ranges from 25 to 500 Pa (0.1 to 2 inH₂O)
- Pressure sensor based on thermal micro-flow measurement
- High flow impedance
 - very low flow-through leakage
 - high immunity to dust and humidity
 - no loss in sensitivity using long tubing
- Calibrated and temperature compensated
- Unique offset autozeroing feature ensuring superb long-term stability
- Offset accuracy better than 0.2% FS
- Total accuracy better than 0.5% FS typical
- On-chip temperature sensor
- Analog output and digital SPI interface
- No position sensitivity

Certificates

- Quality Management System according to EN ISO 13485 and EN ISO 9001
- RoHS and REACH compliant

Media compatibility

Air and other non-corrosive gases

Applications

Medical

- Ventilators
- Spirometers
- CPAP
- Sleep diagnostic equipment
- Nebulizers
- Oxygen conservers/concentrators
- Insufflators/endoscopy

Industrial

- HVAC
 - VAV
 - Filter monitoring
 - Burner control
- Fuel cells
- Gas leak detection
- Gas metering
- Fume hood
- Instrumentation
- Security systems

LDE series – digital low differential pressure sensors

Maximum ratings

Parameter		Min.	Max.	Unit
Supply voltage V_s	LDE...3...	2.70	3.60	V_{DC}
	LDE...6...	4.75	5.25	
Output current			1	mA
Soldering recommendations				
Reflow soldering ^(1,2)				
Average preheating temperature gradient			1.5	K/s
Time above 217 °C			74	s
Time above 240 °C			30	
Peak temperature			245	°C
Cooling temperature gradient			-1.4	K/s
Wave soldering, pot temperature			260	°C
Hand soldering, tip temperature			370	
Temperature ranges				
Compensated		0	+70	
Operating		-20	+80	°C
Storage		-40	+80	
Humidity limits (non-condensing)			97	%RH
Vibration ⁽³⁾			20	
Mechanical shock ⁽⁴⁾			500	g

Pressure sensor characteristics

Part no.	Operating pressure	Proof pressure ⁽⁵⁾	Burst pressure ⁽⁵⁾
LDES025U...	0...25 Pa / 0...0.25 mbar (0.1 inH ₂ O)		
LDES050U...	0...50 Pa / 0...0.5 mbar (0.2 inH ₂ O)		
LDES100U...	0...100 Pa / 0...1 mbar (0.4 inH ₂ O)		
LDES250U...	0...250 Pa / 0...2.5 mbar (1 inH ₂ O)		
LDES500U...	0...500 Pa / 0...5 mbar (2 inH ₂ O)	2 bar (30 psi)	5 bar (75 psi)
LDES025B...	0...±25 Pa / 0...±0.25 mbar (±0.1 inH ₂ O)		
LDES050B...	0...±50 Pa / 0...±0.5 mbar (±0.2 inH ₂ O)		
LDES100B...	0...±100 Pa / 0...±1 mbar (±0.4 inH ₂ O)		
LDES250B...	0...±250 Pa / 0...±2.5 mbar (±1 inH ₂ O)		
LDES500B...	0...±500 Pa / 0...±5 mbar (±2 inH ₂ O)		

Gas correction factors ⁽⁶⁾

Gas type	Correction factor
Dry air	1.0
Oxygen (O ₂)	1.07
Nitrogen (N ₂)	0.97
Argon (Ar)	0.98
Carbon dioxide (CO ₂)	0.56

Specification notes

- (1) Recommendations only. Actually reflow settings depend on many factors, for example, number of oven heating and cooling zones, type of solder paste/flux used, board and component size, as well as component density. It is the responsibility of the customer to fine tune their processes for optimal results.
- (2) Handling instruction: Products are packaged in vacuum sealed moisture barrier bag with a floor life of 168hours (<30C, 60% R.H.). If floor life or environmental conditions have been exceeded prior to reflow assembly, baking is recommended. Recommended bake-out procedure is 72 hours @ 60C.
- (3) Sweep 20 to 2000 Hz, 8 min, 4 cycles per axis, MIL-STD-883, Method 2007.

(4) 5 shocks, 3 axes, MIL-STD-883E, Method 2002.4.

(5) The max. common mode pressure is 5 bar.

(6) For example with a LDES500... sensor measuring CO₂ gas, at full-scale output the actual pressure will be:

$$\Delta P_{\text{eff}} = \Delta P_{\text{Sensor}} \times \text{gas correction factor} = 500 \text{ Pa} \times 0.56 = 280 \text{ Pa}$$

ΔP_{eff} = True differential pressure

ΔP_{Sensor} = Differential pressure as indicated by output signal

LDE series – digital low differential pressure sensors

LDE...6... Performance characteristics ⁽⁷⁾

(V_S=5.0 V_{DC}, T_A=20 °C, P_{Abs}=1 bara, calibrated in air, analog and digital output signals are **non-ratiometric** to V_S)

25 Pa and 50 Pa devices

Parameter	Min.	Typ.	Max.	Unit
Noise level (RMS)		±0.01		Pa
Offset warm-up shift			less than noise	
Offset long term stability ⁽⁸⁾		±0.05	±0.1	Pa/year
Offset repeatability		±0.01		Pa
Span repeatability ^(11, 12)		±0.25		% of reading
Current consumption (no load) ⁽⁹⁾		7	8	mA
Response time (t ₆₃)		5		ms
Power-on time			25	ms

Digital output

Parameter	Min.	Typ.	Max.	Unit	
Scale factor (digital output) ⁽¹⁰⁾	0...25/0...±25 Pa	1200		counts/Pa	
	0...50/0...±50 Pa	600		counts/Pa	
Zero pressure offset accuracy ⁽¹¹⁾		±0.1	±0.2	%FSS	
Span accuracy ^(11, 12)		±0.4	±0.75	% of reading	
Thermal effects	Offset	5...55 °C		±0.2	%FSS
		0...70 °C		±0.4	%FSS
	Span	5...55 °C	±1	±1.75	% of reading
		0...70 °C	±2	±2.75	% of reading

Analog output (unidirectional devices)

Parameter	Min.	Typ.	Max.	Unit	
Zero pressure offset ⁽¹¹⁾	0.49	0.50	0.51	V	
Full scale output		4.50		V	
Span accuracy ^(11, 12)		±0.4	±0.75	% of reading	
Thermal effects	Offset	5...55 °C		±15	mV
		0...70 °C		±30	mV
	Span	5...55 °C	±1.25	±2	% of reading
		0...70 °C	±2	±2.75	% of reading

Analog output (bidirectional devices)

Parameter	Min.	Typ.	Max.	Unit	
Zero pressure offset ⁽¹¹⁾	2.49	2.50	2.51	V	
Output	at max. specified pressure	4.50		V	
	at min. specified pressure	0.50		V	
Span accuracy ^(11, 12)		±0.4	±0.75	% of reading	
Thermal effects	Offset	5...55 °C		±15	mV
		0...70 °C		±30	mV
	Span	5...55 °C	±1.25	±2	% of reading
		0...70 °C	±2	±2.75	% of reading

Specification notes (cont.)

(7) The sensor is calibrated with a common mode pressure of 1 bar absolute. Due to the mass flow based measuring principle, variations in absolute common mode pressure need to be compensated according to the following formula:

$$\Delta P_{\text{eff}} = \Delta P_{\text{Sensor}} \times 1 \text{ bara} / P_{\text{abs}}$$

ΔP_{eff} = True differential pressure

ΔP_{Sensor} = Differential pressure as indicated by output voltage

P_{abs} = Current absolute common mode pressure

(8) Figure based on accelerated lifetime test of 10000 hours at 85 °C biased burn-in.

(9) Please contact First Sensor for low power options.

(10) The digital output signal is a signed, two complement integer. Negative pressures will result in a negative output

(11) Zero pressure offset accuracy and span accuracy are uncorrelated uncertainties. They can be added according to the principles of error propagation.

(12) Span accuracy below 10% of full scale is limited by the intrinsic noise of the sensor.

LDE series – digital low differential pressure sensors

LDE...6... Performance characteristics (cont.) ⁽⁷⁾

(V_S=5.0 V_{DC}, T_A=20 °C, P_{Abs}=1 bara, calibrated in air, analog and digital output signals are **non-ratiometric** to V_S)

100 Pa, 250 Pa and 500 Pa devices

Parameter	Min.	Typ.	Max.	Unit
Noise level (RMS)		±0.01		%FSS
Offset warm-up shift			less than noise	
Offset long term stability ⁽⁸⁾		±0.05	±0.1	%FSS/year
Offset repeatability ⁽¹³⁾		±0.02		Pa
Span repeatability ^(11, 12)		±0.25		% of reading
Current consumption (no load) ⁽⁹⁾		7	8	mA
Response time (t ₆₃)		5		ms
Power-on time			25	ms

Digital output

Parameter	Min.	Typ.	Max.	Unit	
Scale factor (digital output) ⁽¹⁰⁾	0...100/0...±100 Pa	300		counts/Pa	
	0...250/0...±250 Pa	120		counts/Pa	
	0...500/0...±500 Pa	60		counts/Pa	
Zero pressure offset accuracy ⁽¹¹⁾		±0.05	±0.1	%FSS	
Span accuracy ^(11, 12)		±0.4	±0.75	% of reading	
Thermal effects	Offset	5...55 °C		±0.1	%FSS
		0...70 °C		±0.2	%FSS
	Span	5...55 °C	±1	±1.75	% of reading
		0...70 °C	±2	±2.75	% of reading

Analog output (unidirectional devices)

Parameter	Min.	Typ.	Max.	Unit	
Zero pressure offset ⁽¹¹⁾	0.49	0.50	0.51	V	
Full scale output		4.50		V	
Span accuracy ^(11, 12)		±0.4	±0.75	% of reading	
Thermal effects	Offset	5...55 °C		±10	mV
		0...70 °C		±12	mV
	Span	5...55 °C	±1	±1.75	% of reading
		0...70 °C	±2	±2.75	% of reading

Analog output (bidirectional devices)

Parameter	Min.	Typ.	Max.	Unit	
Zero pressure offset ⁽¹¹⁾	2.49	2.50	2.51	V	
Output	at max. specified pressure	4.50		V	
	at min. specified pressure	0.50		V	
Span accuracy ^(11, 12)		±0.4	±0.75	% of reading	
Thermal effects	Offset	5...55 °C		±10	mV
		0...70 °C		±12	mV
	Span	5...55 °C	±1	±1.75	% of reading
		0...70 °C	±2	±2.75	% of reading

Specification notes (cont.)

(7) The sensor is calibrated with a common mode pressure of 1 bar absolute. Due to the mass flow based measuring principle, variations in absolute common mode pressure need to be compensated according to the following formula:

$$\Delta P_{\text{eff}} = \Delta P_{\text{Sensor}} \times 1 \text{ bara} / P_{\text{abs}}$$

ΔP_{eff} = True differential pressure

ΔP_{Sensor} = Differential pressure as indicated by output voltage

P_{abs} = Current absolute common mode pressure

(8) Figure based on accelerated lifetime test of 10000 hours at 85 °C biased burn-in.

(9) Please contact First Sensor for low power options.

(10) The digital output signal is a signed, two complement integer. Negative pressures will result in a negative output

(11) Zero pressure offset accuracy and span accuracy are uncorrelated uncertainties. They can be added according to the principles of error propagation.

(12) Span accuracy below 10% of full scale is limited by the intrinsic noise of the sensor.

(13) Typical value for 250 Pa sensors.

LDE series – digital low differential pressure sensors

LDE...3... Performance characteristics ⁽⁷⁾

(V_S=3.0 V_{DC}, T_A=20 °C, P_{Abs}=1 bara, calibrated in air, analog and digital output signals are **non-ratiometric** to V_S)

25 Pa and 50 Pa devices

Parameter	Min.	Typ.	Max.	Unit
Noise level (RMS)		±0.01		Pa
Offset warm-up shift			less than noise	
Offset long term stability ⁽⁸⁾		±0.05	±0.1	Pa/year
Offset repeatability		±0.01		Pa
Span repeatability ^(11, 12)		±0.25		% of reading
Current consumption (no load) ⁽⁹⁾		14	16	mA
Response time (t ₆₃)		5		ms
Power-on time			25	ms

Digital output

Parameter	Min.	Typ.	Max.	Unit	
Scale factor (digital output) ⁽¹⁰⁾	0...25/0...±25 Pa	1200		counts/Pa	
	0...50/0...±50 Pa	600		counts/Pa	
Zero pressure offset accuracy ⁽¹¹⁾		±0.1	±0.2	%FSS	
Span accuracy ^(11, 12)		±0.4	±0.75	% of reading	
Thermal effects	Offset	5...55 °C		±0.2	%FSS
		0...70 °C		±0.4	%FSS
	Span	5...55 °C	±1	±1.75	% of reading
		0...70 °C	±2	±2.75	% of reading

Analog output (unidirectional devices)

Parameter	Min.	Typ.	Max.	Unit	
Zero pressure offset ⁽¹¹⁾	0.29	0.30	0.31	V	
Full scale output		2.70		V	
Span accuracy ^(11, 12)		±0.4	±0.75	% of reading	
Thermal effects	Offset	5...55 °C		±15	mV
		0...70 °C		±30	mV
	Span	5...55 °C	±1.25	±2	% of reading
		0...70 °C	±2	±2.75	% of reading

Analog output (bidirectional devices)

Parameter	Min.	Typ.	Max.	Unit	
Zero pressure offset ⁽¹¹⁾	1.49	1.50	1.51	V	
Output	at max. specified pressure	2.70		V	
	at min. specified pressure	0.30		V	
Span accuracy ^(11, 12)		±0.4	±0.75	% of reading	
Thermal effects	Offset	5...55 °C		±15	mV
		0...70 °C		±30	mV
	Span	5...55 °C	±1.25	±2	% of reading
		0...70 °C	±2	±2.75	% of reading

Specification notes (cont.)

(7) The sensor is calibrated with a common mode pressure of 1 bar absolute. Due to the mass flow based measuring principle, variations in absolute common mode pressure need to be compensated according to the following formula:

$$\Delta P_{\text{eff}} = \Delta P_{\text{Sensor}} \times 1 \text{ bara} / P_{\text{abs}}$$

ΔP_{eff} = True differential pressure

ΔP_{Sensor} = Differential pressure as indicated by output voltage

P_{abs} = Current absolute common mode pressure

(8) Figure based on accelerated lifetime test of 10000 hours at 85 °C biased burn-in.

(9) Please contact First Sensor for low power options.

(10) The digital output signal is a signed, two complement integer. Negative pressures will result in a negative output

(11) Zero pressure offset accuracy and span accuracy are uncorrelated uncertainties. They can be added according to the principles of error propagation.

(12) Span accuracy below 10% of full scale is limited by the intrinsic noise of the sensor.

LDE series – digital low differential pressure sensors

LDE...3... Performance characteristics (cont.) ⁽⁷⁾

(V_S=3.0 V_{DC}, T_A=20 °C, P_{Abs}=1 bara, calibrated in air, analog and digital output signals are **non-ratiometric** to V_S)

100 Pa, 250 Pa and 500 Pa devices

Parameter	Min.	Typ.	Max.	Unit
Noise level (RMS)		±0.01		%FSS
Offset warm-up shift			less than noise	
Offset long term stability ⁽⁸⁾		±0.05	±0.1	%FSS/year
Offset repeatability ⁽¹³⁾		±0.02		Pa
Span repeatability ^(11, 12)		±0.25		% of reading
Current consumption (no load) ⁽⁹⁾		14	16	mA
Response time (t ₆₃)		5		ms
Power-on time			25	ms

Digital output

Parameter	Min.	Typ.	Max.	Unit	
Scale factor (digital output) ⁽¹⁰⁾	0...100/0...±100 Pa	300		counts/Pa	
	0...250/0...±250 Pa	120		counts/Pa	
	0...500/0...±500 Pa	60		counts/Pa	
Zero pressure offset accuracy ⁽¹¹⁾		±0.05	±0.1	%FSS	
Span accuracy ^(11, 12)		±0.4	±0.75	% of reading	
Thermal effects	Offset	5...55 °C		±0.1	%FSS
		0...70 °C		±0.2	%FSS
	Span	5...55 °C	±1	±1.75	% of reading
		0...70 °C	±2	±2.75	% of reading

Analog output (unidirectional devices)

Parameter	Min.	Typ.	Max.	Unit	
Zero pressure offset ⁽¹¹⁾	0.29	0.30	0.31	V	
Full scale output		2.70		V	
Span accuracy ^(11, 12)		±0.4	±0.75	% of reading	
Thermal effects	Offset	5...55 °C		±10	mV
		0...70 °C		±12	mV
	Span	5...55 °C	±1	±1.75	% of reading
		0...70 °C	±2	±2.75	% of reading

Analog output (bidirectional devices)

Parameter	Min.	Typ.	Max.	Unit	
Zero pressure offset ⁽¹¹⁾	1.49	1.50	1.51	V	
Output	at max. specified pressure	2.70		V	
	at min. specified pressure	0.30		V	
Span accuracy ^(11, 12)		±0.4	±0.75	% of reading	
Thermal effects	Offset	5...55 °C		±10	mV
		0...70 °C		±12	mV
	Span	5...55 °C	±1	±1.75	% of reading
		0...70 °C	±2	±2.75	% of reading

Specification notes (cont.)

(7) The sensor is calibrated with a common mode pressure of 1 bar absolute. Due to the mass flow based measuring principle, variations in absolute common mode pressure need to be compensated according to the following formula:

$$\Delta P_{\text{eff}} = \Delta P_{\text{Sensor}} \times 1 \text{ bara} / P_{\text{abs}}$$

ΔP_{eff} = True differential pressure

ΔP_{Sensor} = Differential pressure as indicated by output voltage

P_{abs} = Current absolute common mode pressure

(8) Figure based on accelerated lifetime test of 10000 hours at 85 °C biased burn-in.

(9) Please contact First Sensor for low power options.

(10) The digital output signal is a signed, two complement integer. Negative pressures will result in a negative output

(11) Zero pressure offset accuracy and span accuracy are uncorrelated uncertainties. They can be added according to the principles of error propagation.

(12) Span accuracy below 10% of full scale is limited by the intrinsic noise of the sensor.

(13) Typical value for 250 Pa sensors.

LDE series – digital low differential pressure sensors

Performance characteristics

Temperature sensor

Parameter	Min.	Typ.	Max.	Unit
Scale factor (digital output)		95		counts/°C
Non-linearity		±0.5		%FS
Hysteresis		±0.1		% FS

Total accuracy ⁽¹⁵⁾

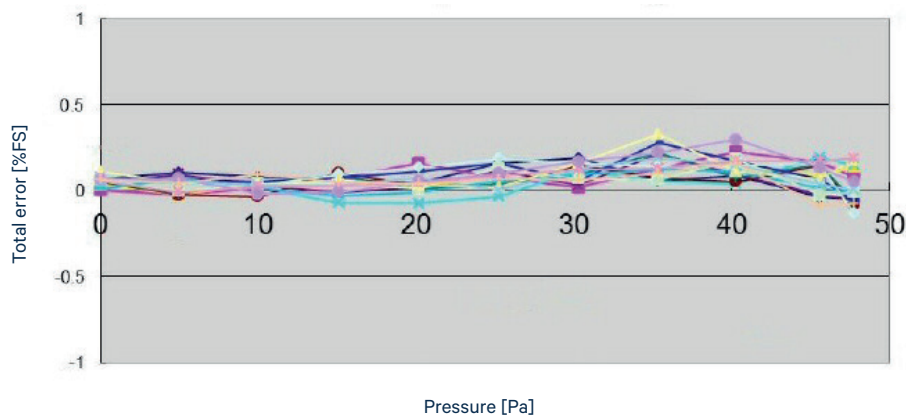

Fig. 1: Typical total accuracy plot of 16 LDE 50 Pa sensors @ 25 °C (typical total accuracy better than 0.5 %FS)

Offset long term stability

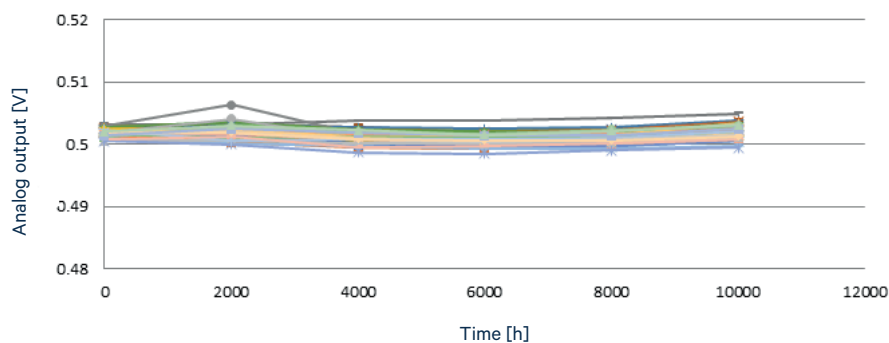

Fig. 2: Offset long term stability for LDE 250 Pa sensors after 10,000 hours @ 85°C powered, equivalent to over 43.5 years @ 25 °C (better than ±2 mV / ±0.125 Pa)

Specification notes (cont.)

(15) Total accuracy is the combined error from offset and span calibration, non-linearity, repeatability and pressure hysteresis

LDE series – digital low differential pressure sensors

SPI – Serial Peripheral Interface

Note: it is important to adhere to the communication protocol in order to avoid damage to the sensor.

Introduction

The LDE serial interface is a high-speed synchronous data input and output communication port. The serial interface operates using a standard 4-wire SPI bus. The LDE device runs in SPI mode 0, which requires the clock line SCLK to idle low (CPOL = 0), and for data to be sampled on the leading clock edge (CPHA = 0). Figure 5 illustrates this mode of operation.

Care should be taken to ensure that the sensor is properly connected to the master microcontroller. Refer to the manufacturer's datasheet for more information regarding physical connections.

Application circuit

The use of pull-up resistors is generally unnecessary for SPI as most master devices are configured for push-pull mode. If pull-up resistors are required for use with 3 V LDE devices, however, they should be greater than 50 k Ω .

There are, however, some cases where it may be helpful to use 33 Ω series resistors at both ends of the SPI lines, as shown in Figure 3.

Signal quality may be further improved by the addition of a buffer as shown in Figure 4. These cases include multiple slave devices on the same bus segment, using a master device with limited driving capability and long SPI bus lines.

If these series resistors are used, they must be physically placed as close as possible to the pins of the master and slave devices.

Signal control

The serial interface is enabled by asserting /CS low. The serial input clock, SCLK, is gated internally to begin accepting the input data at MOSI, or sending the output data on MISO. When /CS rises, the data clocked into MOSI is loaded into an internal register.

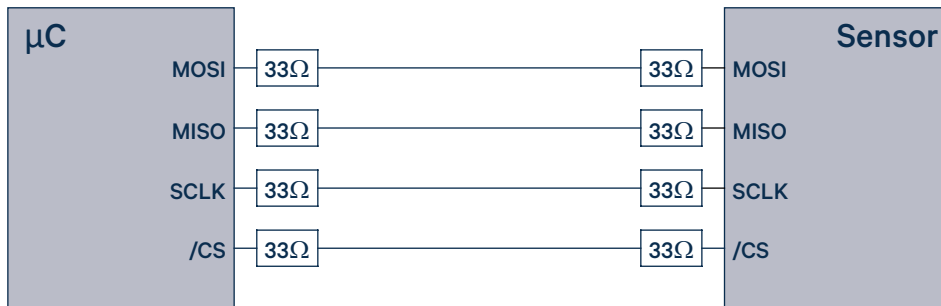

Fig. 3: Application circuit with resistors at both ends of the SPI lines

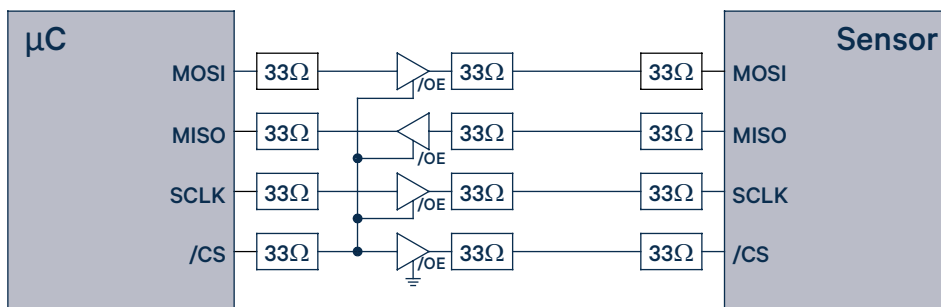

Fig. 4: Application circuit with additional buffer

LDE series – digital low differential pressure sensors

SPI – Serial Peripheral Interface (cont.)

Note: it is important to adhere to the communication protocol in order to avoid damage to the sensor.

Data read – pressure

When powered on, the sensor begins to continuously measure pressure. To initiate data transfer from the sensor, the following three unique bytes must be written sequentially, MSB first, to the MOSI pin (see Figure 5):

Step	Hexadecimal	Binary	Description
1	0x2D	B00101101	Poll current pressure measurement
2	0x14	B00010100	Send result to data register
3	0x98	B10011000	Read data register

The entire 16 bit content of the LDE register is then read out on the MISO pin, MSB first, by applying 16 successive clock pulses to SCLK with /CS asserted low.

From the digital sensor output the actual pressure value can be calculated as follows:

$$\text{Pressure [Pa]} = \frac{\text{Digital output [counts]}}{\text{Scale factor} \left[\frac{\text{counts}}{\text{Pa}} \right]}$$

For example, for a ±250 Pa sensor (LDES250B...) with a scale factor of 120 a digital output of 30 000 counts (7530'h) calculates to a positive pressure of 250 Pa. Similarly, a digital output of -30 000 counts (8AD0'h) calculates to a negative pressure of -250 Pa.

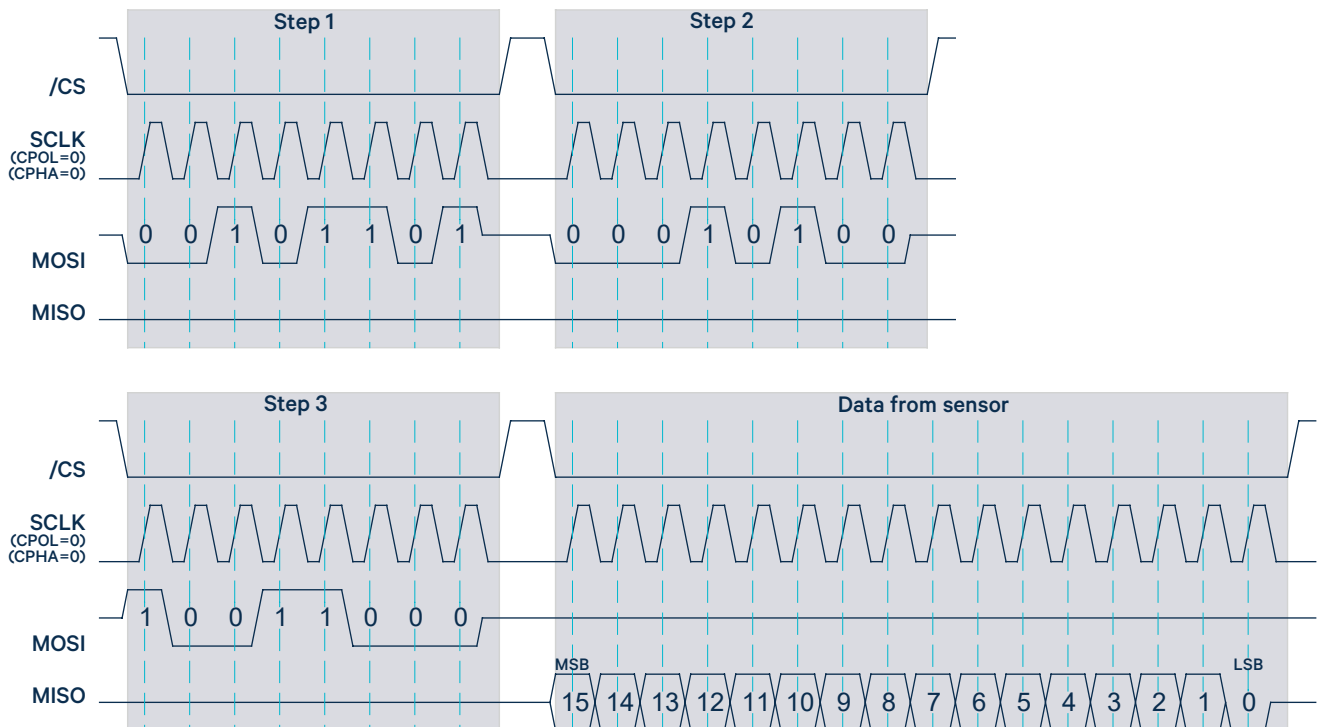

Fig. 5: SPI data transfer

LDE series – digital low differential pressure sensors

SPI – Serial Peripheral Interface (cont.)

Data read – temperature

The on-chip temperature sensor changes 95 counts/°C over the operating range. The temperature data format is 15-bit plus sign in two's complement format. To read temperature, use the following sequence:

Step	Hexadecimal	Binary	Description
1	0x2A	B00101010	Poll current temperature measurement
2	0x14	B00010100	Send result to data register
3	0x98	B10011000	Read data register

From the digital sensor output, the actual temperature can be calculated as follows:

$$\text{Temperature [}^{\circ}\text{C]} = \frac{\text{TS} - \text{TS}_0 \text{ [counts]}}{\text{Scale factor}_{\text{TS}} \left[\frac{\text{counts}}{^{\circ}\text{C}} \right]} + T_0 \text{ [}^{\circ}\text{C]}$$

where

TS is the actual sensor readout;

TS₀ is the sensor readout at known temperature T₀⁽¹³⁾;

Scale factor_{TS} = 95 counts/°C

Specification notes (cont.)

(16) To be defined by user. The results show deviation (in °C) from the offset calibrated temperature.

LDE series – digital low differential pressure sensors

SPI – Serial Peripheral Interface (cont.)

Interface specification

Parameter	Symbol	Conditions	Min.	Typ.	Max.	Unit
External clock frequency	f_{ECLK}	$V_{CKSEL}=0$	Min. Max.	0.2 5		MHz
External master clock input low time	$t_{ECLKIN LO}$	$t_{ECLK}=1/f_{ECLK}$	40		60	$\%t_{ECLK}$
External master clock input high time	$t_{ECLKIN HI}$	$t_{ECLK}=1/f_{ECLK}$	40		60	$\%t_{ECLK}$
SCLK setup to falling edge /CS	t_{SC}		30			ns
/CS falling edge to SCLK rising edge setup time	t_{CSS}		30			
/CS idle time	t_{CSI}	$f_{CLK}=4 \text{ MHz}$	1.5			μs
SCLK falling edge to data valid delay	t_{DO}	$C_{LOAD}=15 \text{ pF}$			80	
Data valid to SCLK rising edge setup time	t_{DS}		30			
Data valid to SCLK rising edge hold time	t_{DH}		30			
SCLK high pulse width	t_{CH}		100			
SCLK low pulse width	t_{CL}		100			ns
/CS rising edge to SCLK rising edge hold time	t_{CSH}		30			
/CS falling edge to output enable	t_{DV}	$C_{LOAD}=15 \text{ pF}$			25	
/CS rising edge to output disable	t_{TR}	$C_{LOAD}=15 \text{ pF}$			25	
LDE...6... (5 V supply)						
Maximum output load capacitance	C_{LOAD}	$R_{LOAD}=\infty$, phase margin $>55^\circ$		200		pF
Input voltage, logic HIGH	V_{IH}		$0.8 \times V_S$		$V_S+0.3$	
Input voltage, logic LOW	V_{IL}				$0.2 \times V_S$	
Output voltage, logic HIGH	V_{OH}	$R_{LOAD}=\infty$	$V_S-0.1$			V
Output voltage, logic LOW	V_{OL}	$R_{LOAD}=2 \text{ k}\Omega$	$V_S-0.15$			
		$R_{LOAD}=\infty$			0.5	
		$R_{LOAD}=2 \text{ k}\Omega$			0.2	
LDE...3... (3 V supply) ⁽¹⁷⁾						
Maximum output load capacitance	C_{LOAD}	$R_{LOAD}=1 \text{ k}\Omega$		15		pF
Input voltage, logic HIGH	V_{IH}		$0.65 \times V_S$		$V_S+0.3$	
Input voltage, logic LOW	V_{IL}				$0.35 \times V_S$	
Output voltage, logic HIGH	V_{OH}	$I_O=-20 \mu\text{A}$	$V_S-0.4$			V
Output voltage, logic LOW	V_{OL}	$I_O=+20 \mu\text{A}$			0.4	

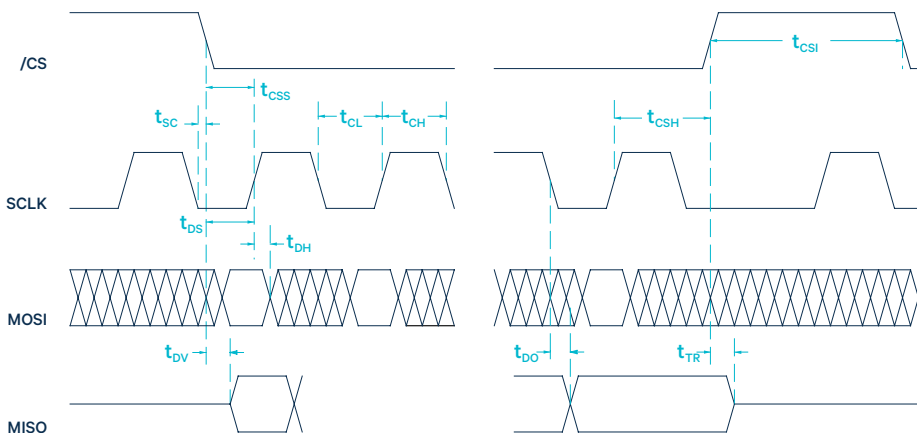

Fig. 6: SPI timing diagram

Specification notes (cont.)

(17) For correct operation of LDE...3... devices, the device driving the SPI bus must have a minimum drive capability of $\pm 2 \text{ mA}$.

LDE series – digital low differential pressure sensors

Dimensional drawing

– LDE...E... (SMD, 2 ports same side)

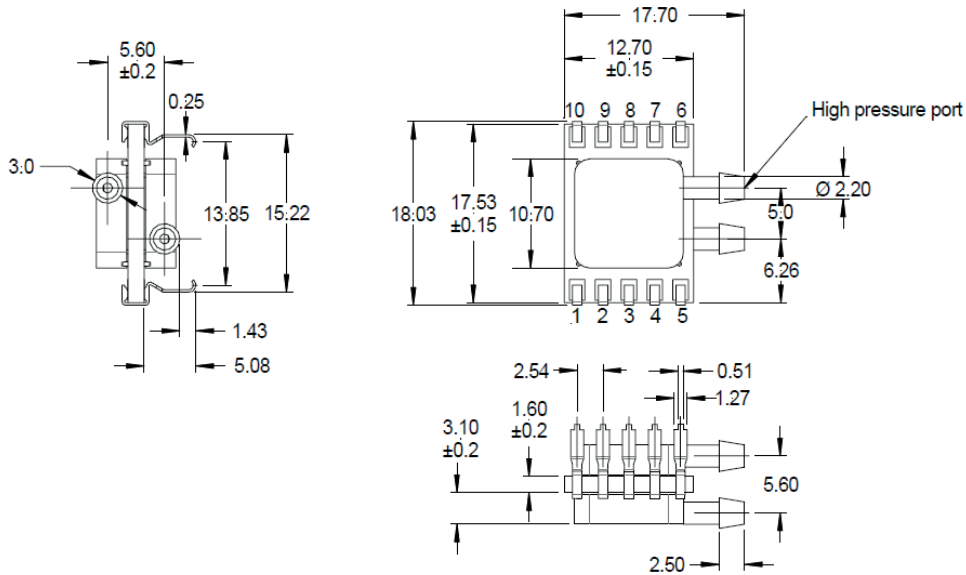

dimensions in mm,
all tolerances ±0.1 mm
unless otherwise noted

– LDE...F... (DIP, 2 ports same side)

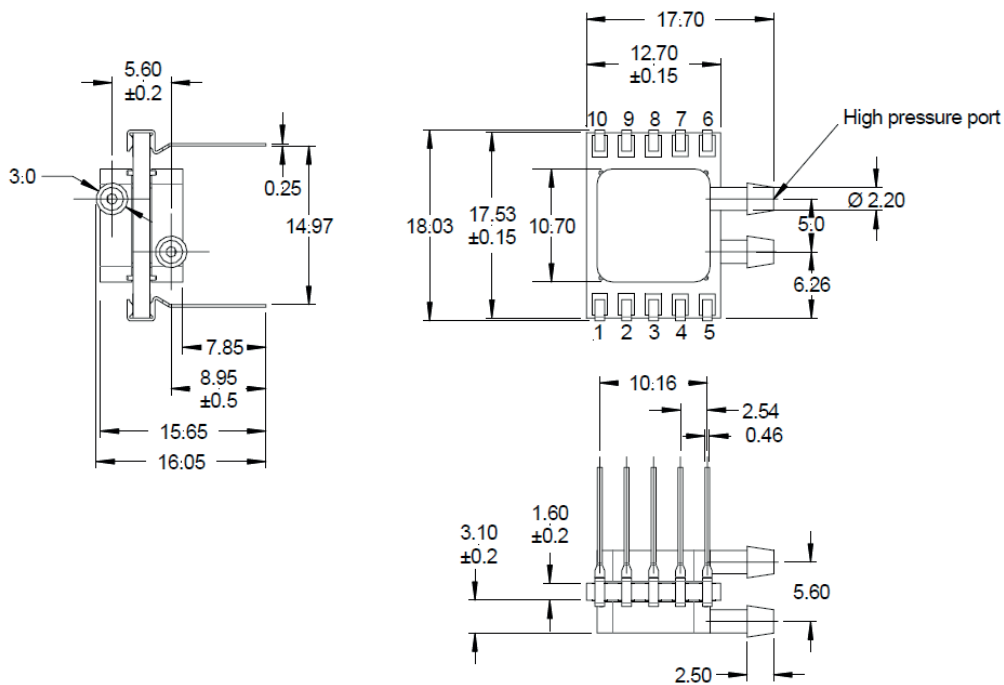

dimensions in mm,
all tolerances ±0.1 mm
unless otherwise noted