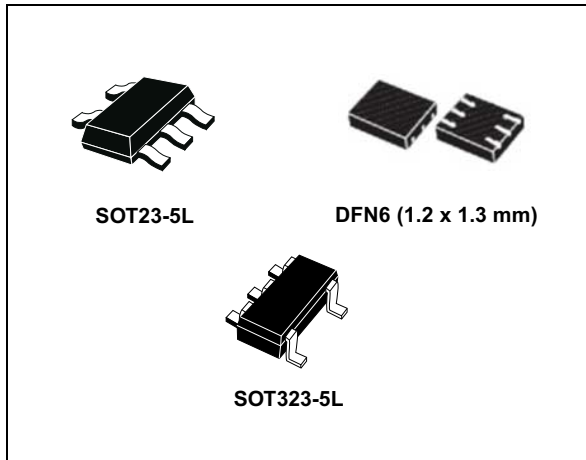

200 mA low quiescent current very low noise LDO

Datasheet - production data

**Features**

- Input voltage from 1.9 to 5.5 V
- Very low dropout voltage (100 mV typ. at 100 mA load)
- Low quiescent current (max. 100 μ A, 1 μ A in OFF mode)
- Very low noise
- Output voltage tolerance: $\pm 2.0\%$ @ 25 $^{\circ}$ C
- 200 mA guaranteed output current
- Wide range of fixed output voltages available on request: from 0.8 V to 3.5 V with 100 mV step
- Adjustable version: from 0.8 V to $V_{IN} - V_{drop}$
- Logic-controlled electronic shutdown
- Compatible with ceramic capacitor $C_{OUT} = 1 \mu$ F
- Internal current and thermal limit
- Available in SOT23-5L, SOT323-5L and DFN6 (1.2 x 1.3 mm) packages
- Temperature range: -40 $^{\circ}$ C to 125 $^{\circ}$ C

Applications

- Mobile phones
- Personal digital assistants (PDAs)
- Cordless phones and similar battery-powered systems
- Digital still cameras

Description

The LDK120 low drop voltage regulator provides 200 mA of maximum current from an input supply voltage in the range of 1.9 V to 5.5 V, with a typical dropout voltage of 100 mV.

It is stabilized with a ceramic capacitor on the output.

The very low drop voltage, low quiescent current and low noise features make it suitable for low power battery-powered applications.

An enable logic control function puts the LDK120 in shutdown mode allowing a total current consumption lower than 1 μ A.

The device also includes a short-circuit constant current limiting and thermal protection.

Contents

| | | |
|----|---|----|
| 1 | Diagram | 3 |
| 2 | Pin configuration | 4 |
| 3 | Typical application | 5 |
| 4 | Maximum ratings | 6 |
| 5 | Electrical characteristics | 7 |
| 6 | Typical performance characteristics | 9 |
| 7 | Package mechanical data | 14 |
| 8 | Packaging mechanical data | 20 |
| 9 | Order codes | 22 |
| 10 | Revision history | 23 |

1 Diagram

Figure 1. Block diagram

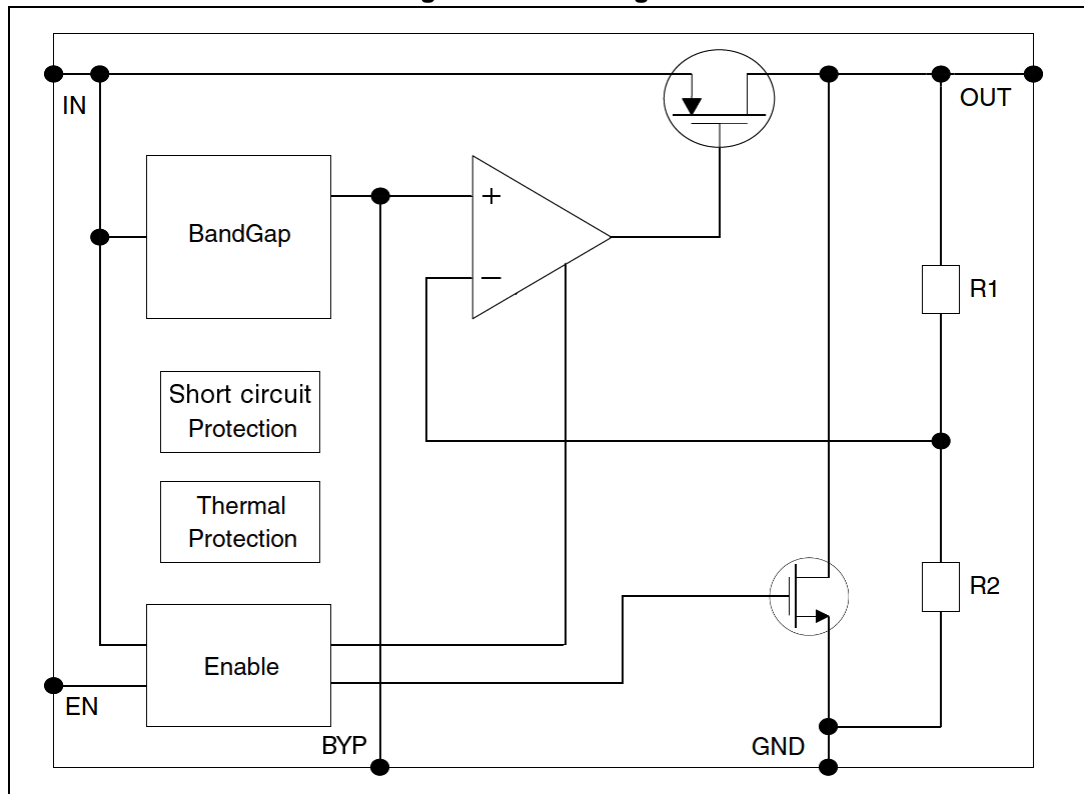

2 Pin configuration

Figure 2. Pin connection (top view)

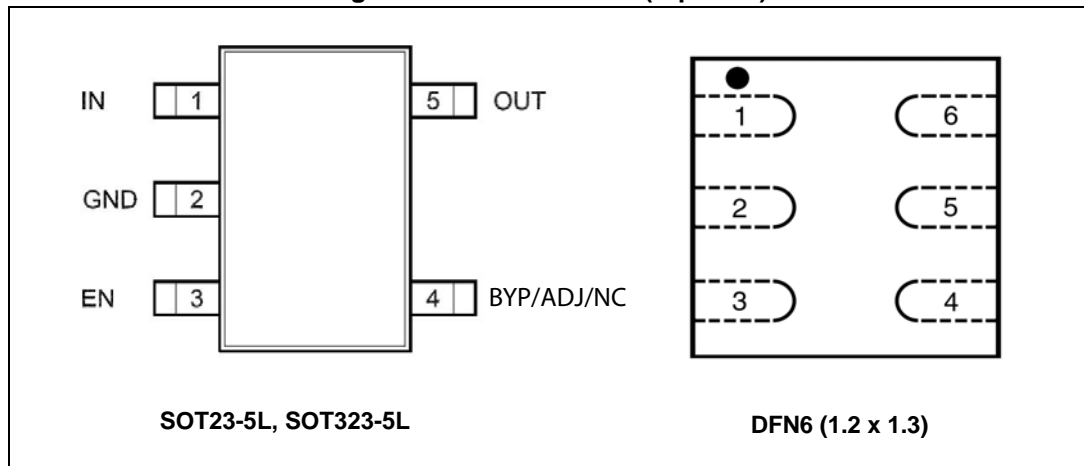

Table 1. Pin description (SOT23-5L, SOT323-5L)

| Pin | | Symbol | Function | | |
|------------------|------|--------------------------------|---|----------------|--------------------------|
| SOT23/ SOT323 | DFN6 | | Fixed | Adjustable | D version |
| 1 | 6 | IN | Input voltage of the LDO | | |
| 2 | 2 | GND | Common ground | | |
| 3 | 4 | EN | Enable pin logic input: Low = shutdown, High = active | | |
| 4 | 3 | BYP ⁽¹⁾ /ADJ /NC | Bypass capacitor | Adjustable pin | Internally not connected |
| 5 | 1 | OUT | Output voltage of the LDO | | |
| - | 5 | N/C | Not connected. This pin should be connected to GND | | |

1. Bypass capacitor for noise reduction on fixed version is optional, if not used the relevant pin must be left floating with no routing on the board.

3 Typical application

Figure 3. Typical application circuits for fixed version

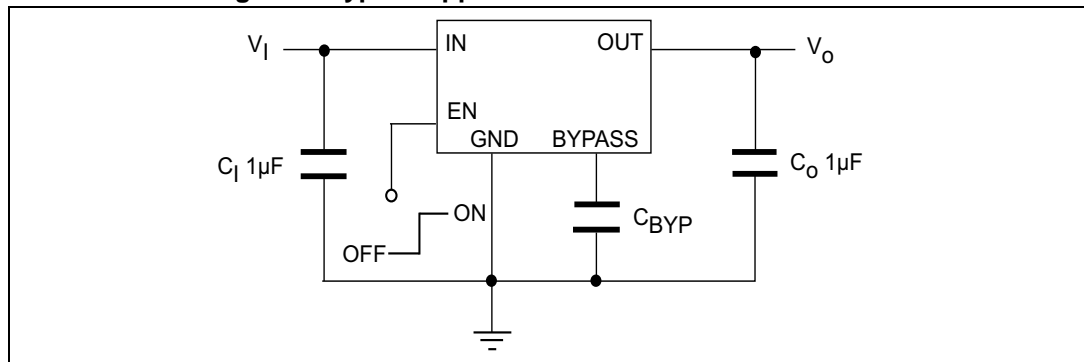

Figure 4. Typical application circuits for D version

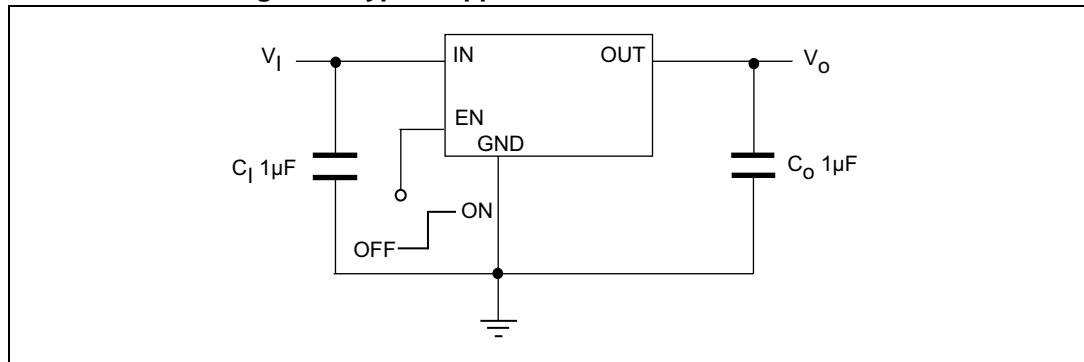
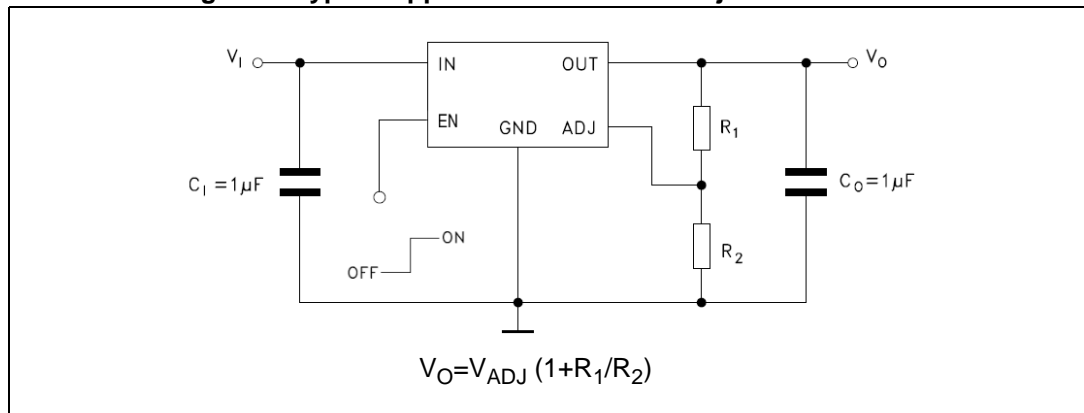

Figure 5. Typical application circuits for adjustable version



4 Maximum ratings

Table 2. Absolute maximum ratings

| Symbol | Parameter | Value | Unit |
|---------------|--------------------------------------|----------------------|------|
| V_{IN} | DC input voltage | - 0.3 to 7 | V |
| V_{OUT} | DC output voltage | - 0.3 to $V_I + 0.3$ | V |
| V_{EN} | Enable input voltage | - 0.3 to $V_I + 0.3$ | V |
| $V_{BYP/ADJ}$ | ADJ/Bypass pin voltage | 2 | V |
| I_{OUT} | Output current | Internally limited | mA |
| P_D | Power dissipation | Internally limited | mW |
| T_{STG} | Storage temperature range | - 65 to 150 | °C |
| T_{OP} | Operating junction temperature range | - 40 to 125 | °C |

Note: Absolute maximum ratings are those values beyond which damage to the device may occur. Functional operation under these conditions is not implied. All values are referred to GND.

Table 3. Thermal data

| Symbol | Parameter | SOT23-5L | SOT323-5L | DFN-6L | Unit |
|------------|-------------------------------------|----------|-----------|--------|------|
| R_{thJA} | Thermal resistance junction-ambient | 160 | 246 | 237 | °C/W |
| R_{thJC} | Thermal resistance junction-case | 68 | 134 | 104 | °C/W |

5 Electrical characteristics

$T_J = 25\text{ °C}$, $V_{IN} = V_{OUT(NOM)} + 1\text{ V}$, $C_{IN} = C_{OUT} = 1\text{ }\mu\text{F}$, $I_{OUT} = 1\text{ mA}$, $V_{EN} = V_{IN}$, unless otherwise specified.

Table 4. Electrical characteristics for LDK120 (fixed version)

| Symbol | Parameter | Test conditions | Min. | Typ. | Max. | Unit |
|------------------|--------------------------------|---|------|-------|------|---------------------|
| V_{IN} | Operating input voltage | | 1.9 | | 5.5 | V |
| V_{OUT} | V_{OUT} accuracy | $I_{OUT}=1\text{ mA}$, $T_J=25\text{ °C}$ | -2.0 | | 2.0 | % |
| | | $I_{OUT}=1\text{ mA}$, $-40\text{ °C}<T_J<125\text{ °C}$ | -3.0 | | 3.0 | % |
| ΔV_{OUT} | Static line regulation | $V_{OUT} + 1\text{ V} \leq V_{IN} \leq 5.5\text{ V}$, $I_{OUT}=1\text{ mA}$ | | 0.05 | | %/V |
| ΔV_{OUT} | Static load regulation | $I_{OUT} = 1\text{ mA}$ to 200 mA | | 0.006 | | %/mA |
| V_{DROP} | Dropout voltage ⁽¹⁾ | $I_{OUT} = 100\text{ mA}$, $V_{OUT}=2.5\text{ V}$ | | 100 | | mV |
| | | $I_{OUT} = 200\text{ mA}$, $V_{OUT}=2.5\text{ V}$ $40\text{ °C}<T_J<125\text{ °C}$ | | 150 | 300 | |
| e_N | Output noise voltage | 10 Hz to 100 kHz, $I_{OUT}=10\text{ mA}$, $V_{OUT}=2.5\text{ V}$, $C_{BYP}=10\text{ nF}$ | | 51 | | μV_{RMS} |
| $e_N^{(2)}$ | Output noise voltage | 10 Hz to 100 kHz, $I_{OUT}=10\text{ mA}$, $V_{OUT}=2.5\text{ V}$ | | 148 | | μV_{RMS} |
| SVR | Supply voltage rejection | $V_{IN}=V_{OUTNOM}+0.5\text{ V} \pm V_{RIPPLE}$ $V_{RIPPLE}=0.1\text{ V}$ Freq.=120 Hz to 10 kHz $I_{OUT}=10\text{ mA}$ | | 55 | | dB |
| I_Q | Quiescent current | $I_{OUT}=0\text{ mA}$, $-40\text{ °C}<T_J<125\text{ °C}$ | | 30 | 60 | μA |
| | | $I_{OUT}=200\text{ mA}$, $-40\text{ °C}<T_J<125\text{ °C}$ | | 50 | 100 | |
| | | V_{IN} input current in OFF mode: $V_{EN}=\text{GND}$ | | | 1 | |
| I_{SC} | Short-circuit current | $R_L=0$ | | 400 | | mA |
| V_{EN} | Enable input logic low | $V_{IN}=1.9\text{ V}$ to 5.5 V, $-40\text{ °C}<T_J<125\text{ °C}$ | | | 0.4 | V |
| | Enable input logic high | $V_{IN}=1.9\text{ V}$ to 5.5 V, $-40\text{ °C}<T_J<125\text{ °C}$ | 1.2 | | | |
| I_{EN} | Enable pin input current | $V_{SHDN}=V_{IN}$ | | | 100 | nA |
| T_{SHDN} | Thermal shutdown | | | 160 | | °C |
| | Hysteresis | | | 20 | | |
| C_{OUT} | Output capacitor | Capacitance (see Section 6: Typical performance characteristics) | 1 | | 22 | μF |

- Dropout voltage is the input-to-output voltage difference at which the output voltage is 100 mV below its nominal value.
- Valid for D version or standard version without C_{BYP} .

$T_J = 25\text{ °C}$, $V_{IN} = V_{OUT(NOM)} + 1\text{ V}$, $C_{IN} = C_{OUT} = 1\text{ }\mu\text{F}$, $I_{OUT} = 1\text{ mA}$, $V_{EN} = V_{IN}$, unless otherwise specified.

Table 5. Electrical characteristics for LDK120 (adjustable version)

| Symbol | Parameter | Test conditions | Min. | Typ. | Max. | Unit |
|------------------|--------------------------------|---|------|-------|------|---------------------|
| V_{IN} | Operating input voltage | | 1.9 | | 5.5 | V |
| V_{ADJ} | V_{ADJ} accuracy | $I_{OUT}=1\text{ mA}$, $T_J=25\text{ °C}$ | 784 | 800 | 816 | mV |
| | | $I_{OUT}=1\text{ mA}$, $-40\text{ °C}<T_J<125\text{ °C}$ | -3.0 | | 3.0 | % |
| ΔV_{OUT} | Static line regulation | $V_{OUT} + 1\text{ V} \leq V_{IN} \leq 5.5\text{ V}$, $I_{OUT}=1\text{ mA}$ | | 0.05 | | %/V |
| ΔV_{OUT} | Static load regulation | $I_{OUT}=1\text{ mA}$ to 200 mA | | 0.006 | | %/mA |
| V_{DROP} | Dropout voltage ⁽¹⁾ | $I_{OUT}=100\text{ mA}$, $V_{OUT}=2.5\text{ V}$ | | 100 | | mV |
| | | $I_{OUT} = 200\text{ mA}$, $V_{OUT}=2.5\text{ V}$ $40\text{ °C}<T_J<125\text{ °C}$, | | 150 | 300 | |
| e_N | Output noise voltage | 10 Hz to 100 kHz, $I_{OUT}=10\text{ mA}$ $V_{OUT}=V_{ADJ}$ | | 115 | | μV_{RMS} |
| I_{ADJ} | Adjust pin current | | | | 1 | μA |
| SVR | Supply voltage rejection | $V_{IN}=V_{OUTNOM}+0.5\text{ V} \pm V_{RIPPLE}$ $V_{RIPPLE}=0.1\text{ V}$ Freq.=120 Hz to 10 kHz $I_{OUT}=10\text{ mA}$ | | 55 | | dB |
| I_Q | Quiescent current | $I_{OUT}=0\text{ mA}$, $-40\text{ °C}<T_J<125\text{ °C}$ | | 30 | 60 | μA |
| | | $I_{OUT}=200\text{ mA}$, $-40\text{ °C}<T_J<125\text{ °C}$ | | 50 | 100 | |
| | | V_{IN} input current in OFF mode: $V_{EN}=GND$ | | | 1 | |
| I_{SC} | Short-circuit current | $R_L=0$ | | 400 | | mA |
| V_{EN} | Enable input logic low | $V_{IN}=1.9\text{ V}$ to 5.5 V, $-40\text{ °C}<T_J<125\text{ °C}$ | | | 0.4 | V |
| | Enable input logic high | $V_{IN}=1.9\text{ V}$ to 5.5 V, $-40\text{ °C}<T_J<125\text{ °C}$ | 1.2 | | | |
| I_{EN} | Enable pin input current | $V_{SHDN}=V_{IN}$ | | | 100 | nA |
| T_{SHDN} | Thermal shutdown | | | 160 | | $^{\circ}\text{C}$ |
| | Hysteresis | | | 20 | | |
| C_{OUT} | Output capacitor | Capacitance (see Section 6: Typical performance characteristics) | 1 | | 22 | μF |

1. Dropout voltage is the input-to-output voltage difference at which the output voltage is 100 mV below its nominal value.

6 Typical performance characteristics

$C_{IN} = C_{OUT} = 1 \mu\text{F}$, V_{EN} to V_{IN} , unless otherwise specified.

Figure 6. Output voltage vs. temp. for adjustable ($I_O = 1 \text{ mA}$)

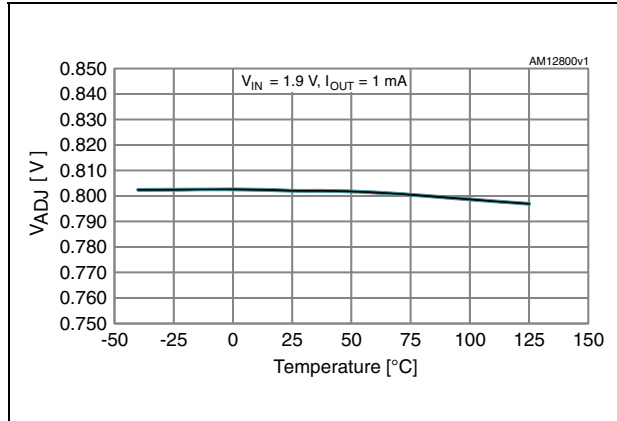

Figure 7. Output voltage vs. temp. for adjustable version ($I_O = 200 \text{ mA}$)

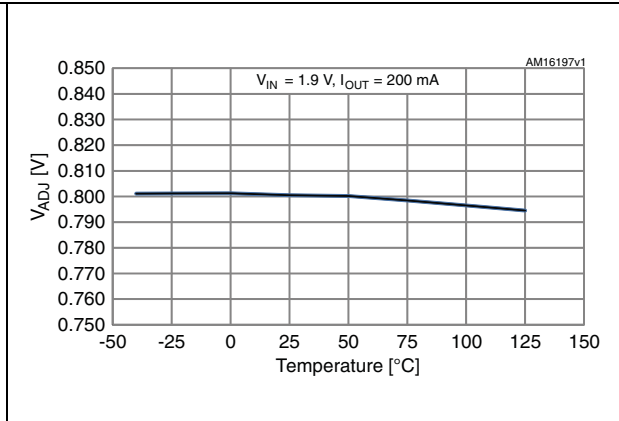

Figure 8. Output voltage vs. temp. for fixed version ($I_O = 1 \text{ mA}$)

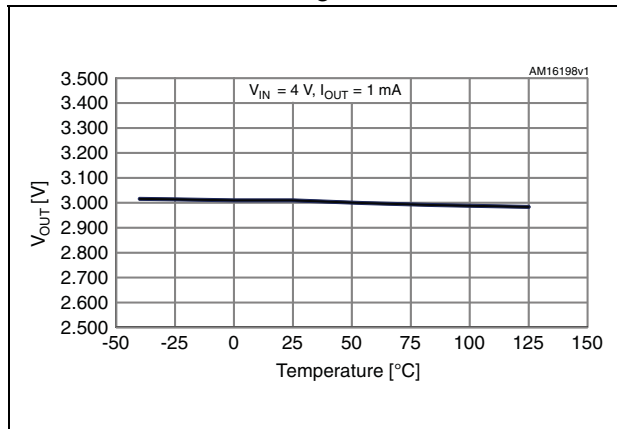

Figure 9. Output voltage vs. temp. for fixed version ($I_O = 200 \text{ mA}$)

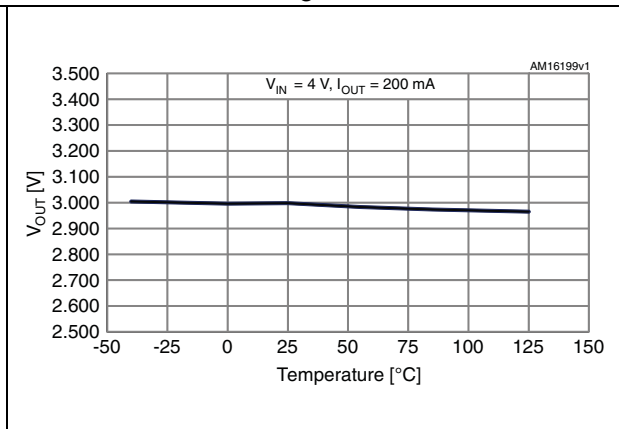

Figure 10. Line regulation vs. temp. for adjustable version

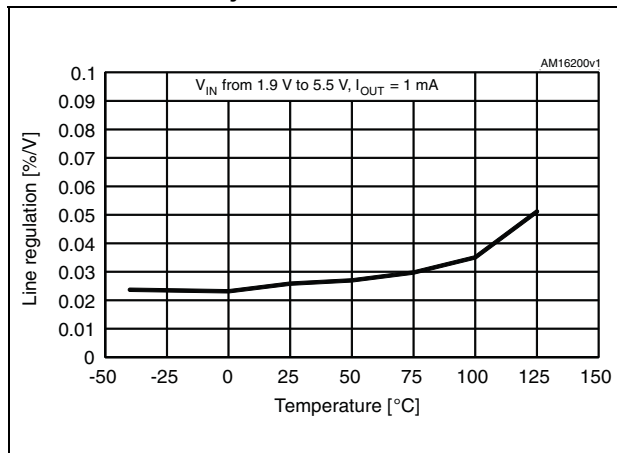

Figure 11. Short-circuit current vs. temp. for adjustable version

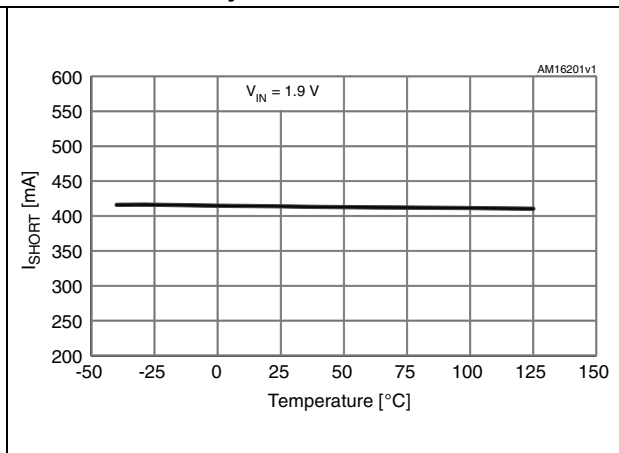

Figure 12. Load regulation vs. temp. for adjustable version

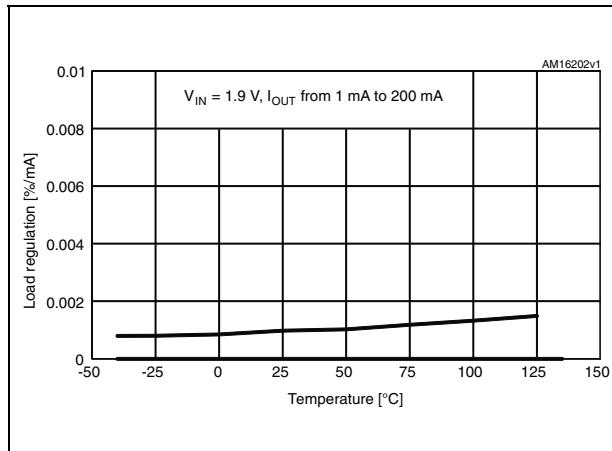

Figure 13. Load regulation vs. temp. for fixed version

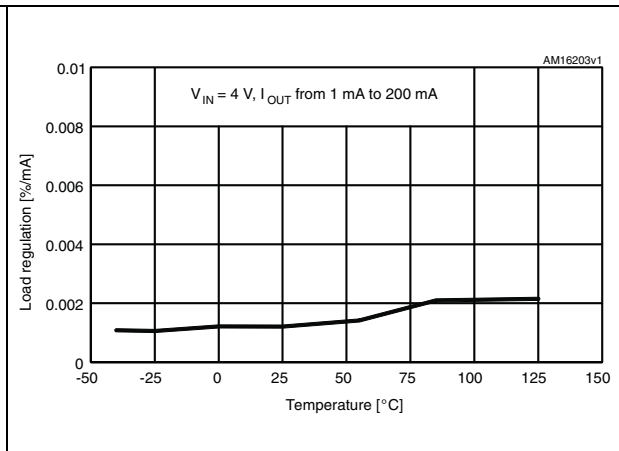

Figure 14. Enable pin thresholds vs. temp. (V_IN = 1.9 V)

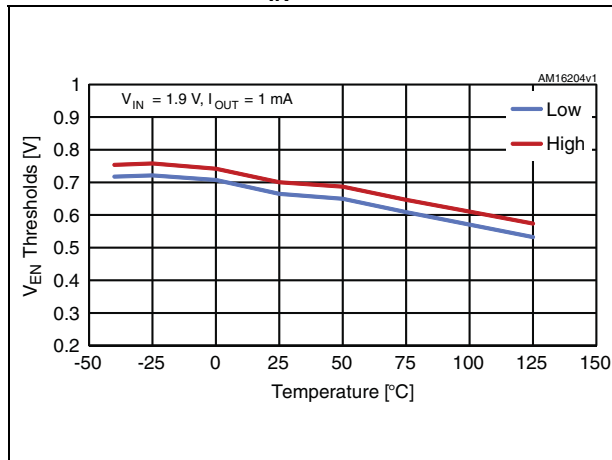

Figure 15. Enable pin thresholds vs. temp.

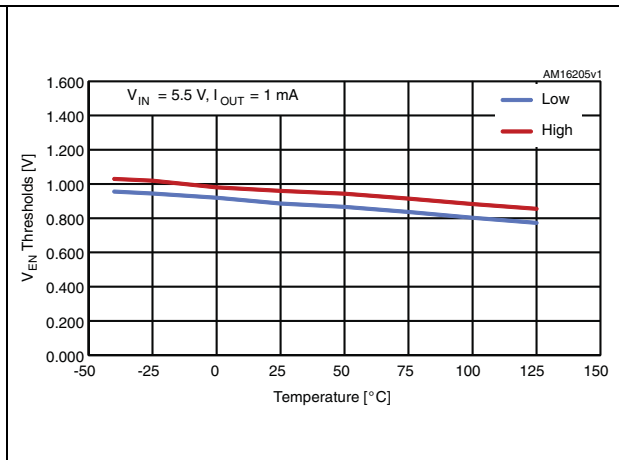

Figure 16. Quiescent current vs. temp. for adjustable version (I_O = 0 mA)

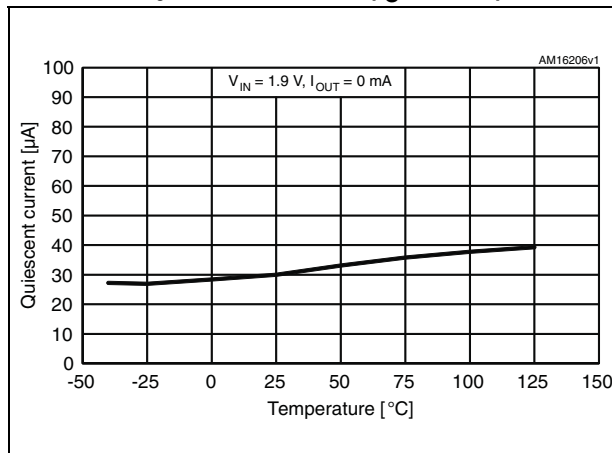

Figure 17. Quiescent current vs. temp. for adjustable version (I_O = 200 mA)

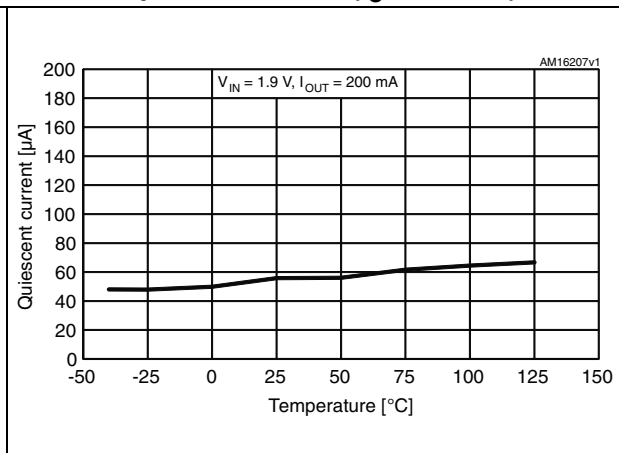

Figure 18. Quiescent current vs. temp. for fixed version ($I_O = 0 \text{ mA}$)

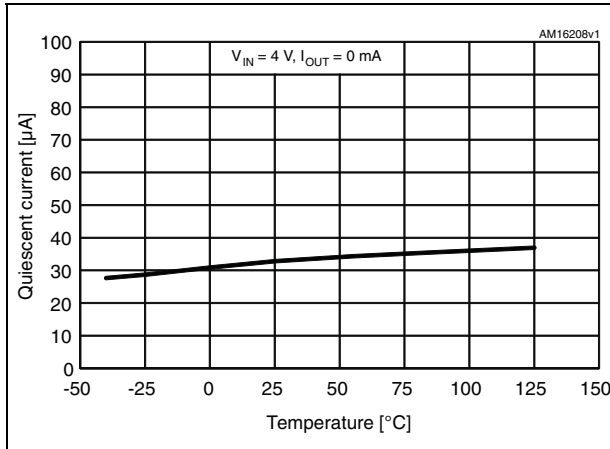

Figure 19. Quiescent current vs. temp. for fixed version ($I_O = 200 \text{ mA}$)

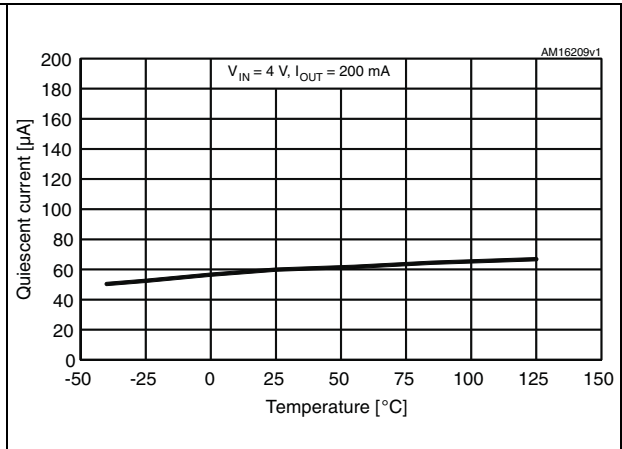

Figure 20. Shutdown current vs. temperature

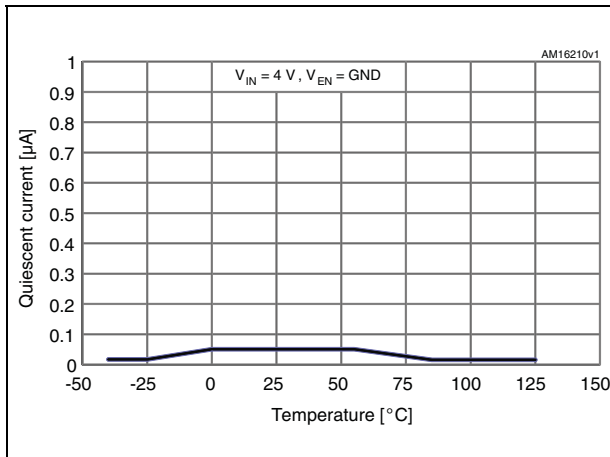

Figure 21. SVR vs. frequency ($V_O = 2.5 \text{ V}$)

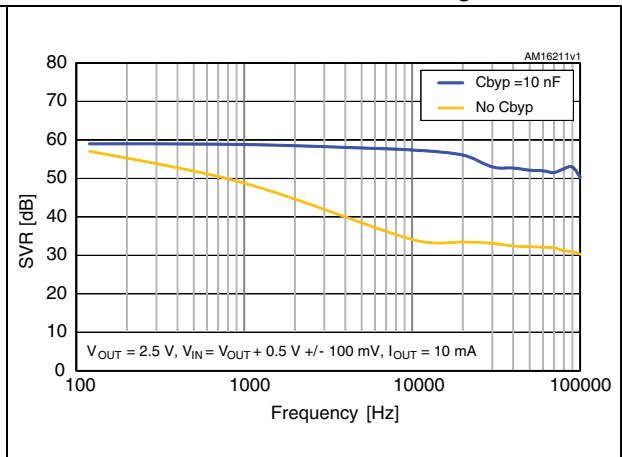

Figure 22. SVR vs. frequency ($V_O = V_{ADJ}$)

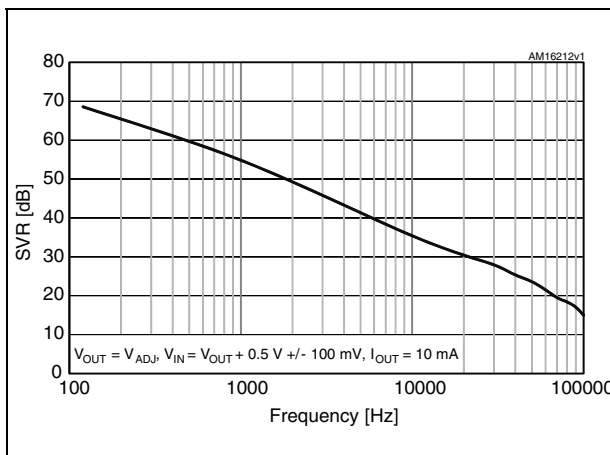

Figure 23. Output noise vs. frequency ($V_O = 2.5 \text{ V}$)

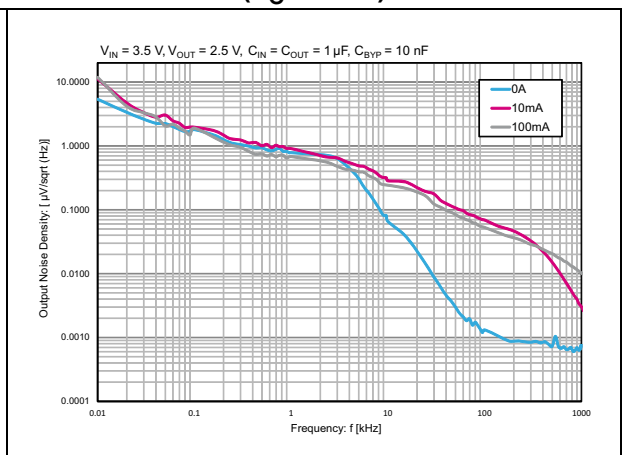

Figure 24. Output noise vs. frequency ($V_O = V_{ADJ}$)

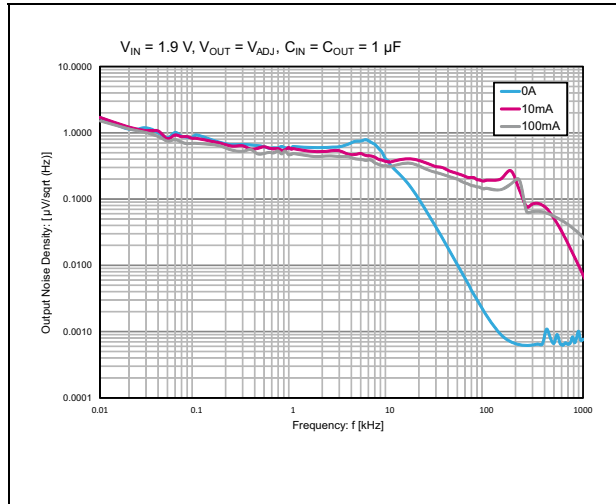

Figure 25. Stability region vs. C_{OUT} (fixed)

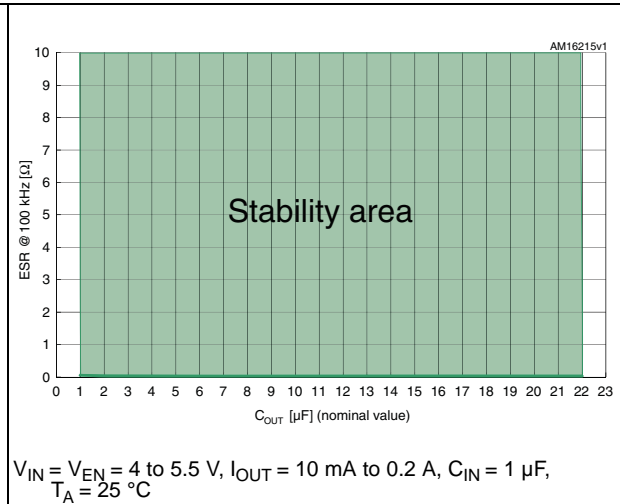

Figure 26. Stability region vs C_{OUT} (adjust.)

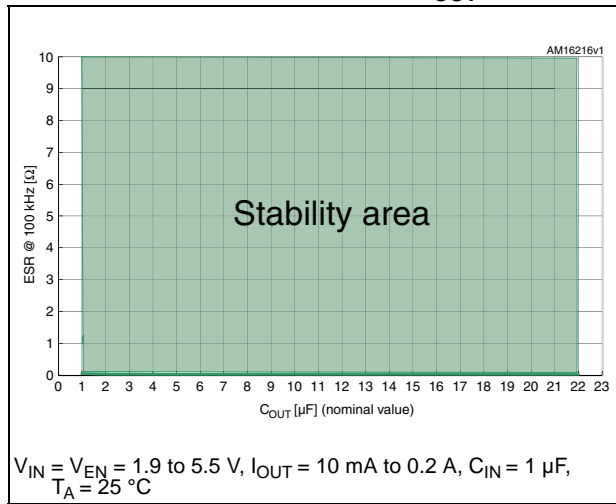

Figure 27. Line transient ($V_{OUT} = V_{ADJ}$)

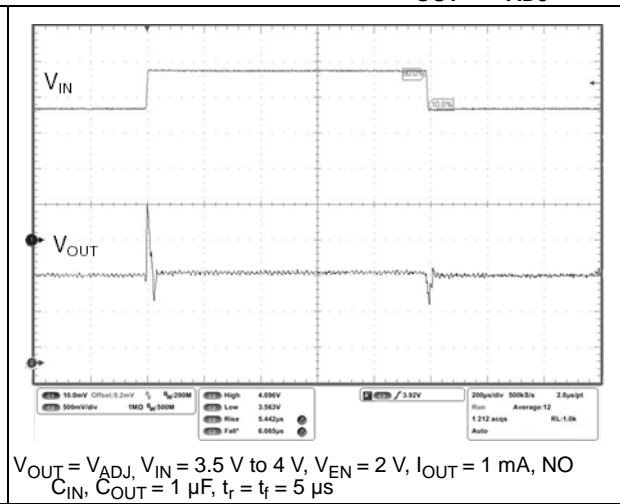

Figure 28. Line transient ($V_{OUT} = 3 V$)

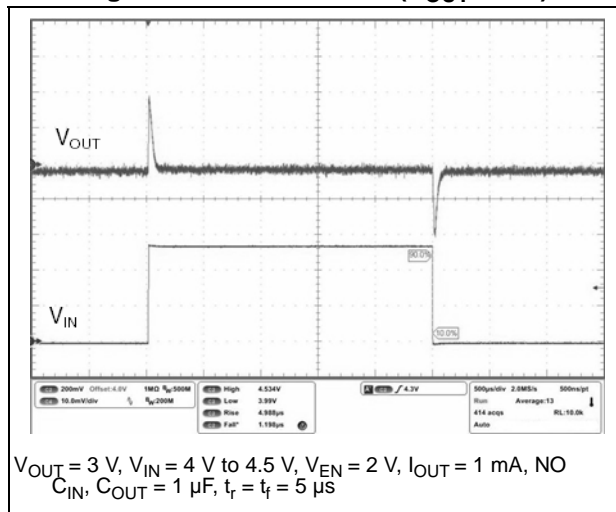

Figure 29. Load transient ($V_{OUT} = 3 V$)

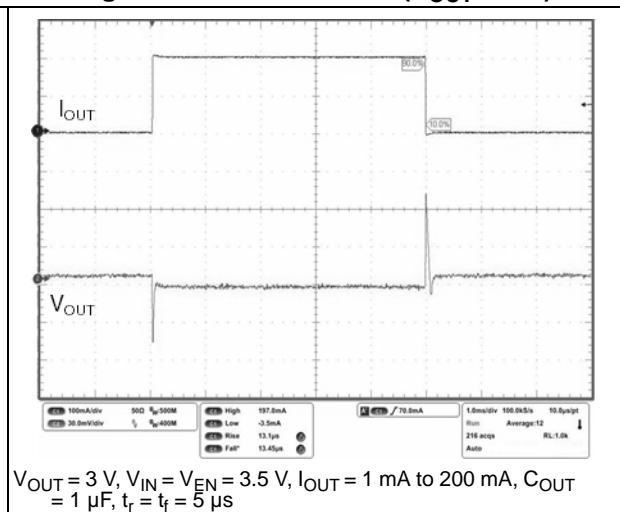

Figure 30. Load transient ($V_{OUT} = V_{ADJ}$)

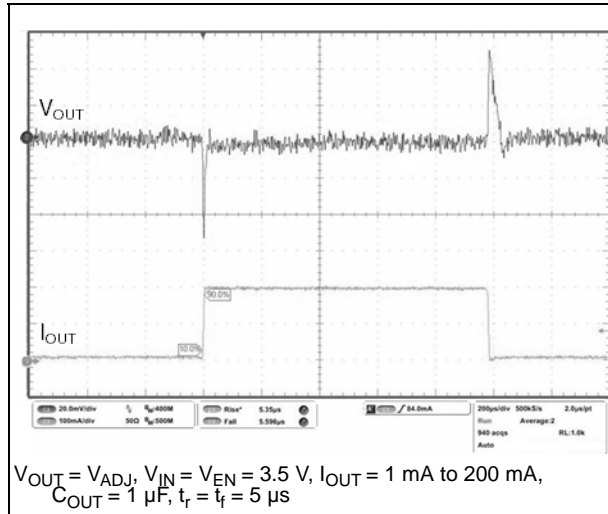

Figure 31. Startup transient

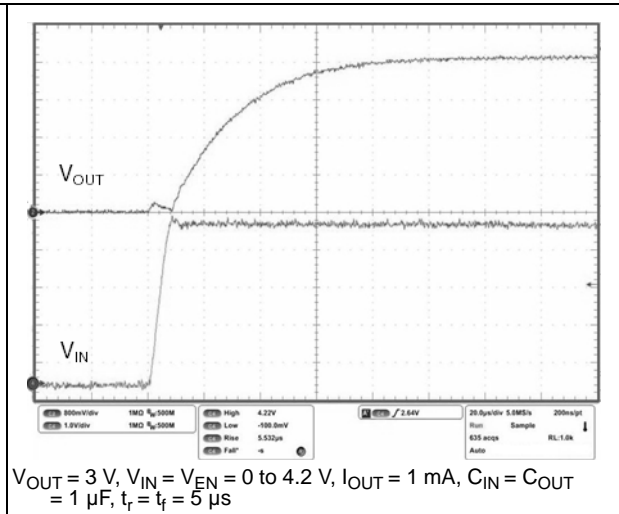

Figure 32. Enable transient ($V_{OUT} = V_{ADJ}$)

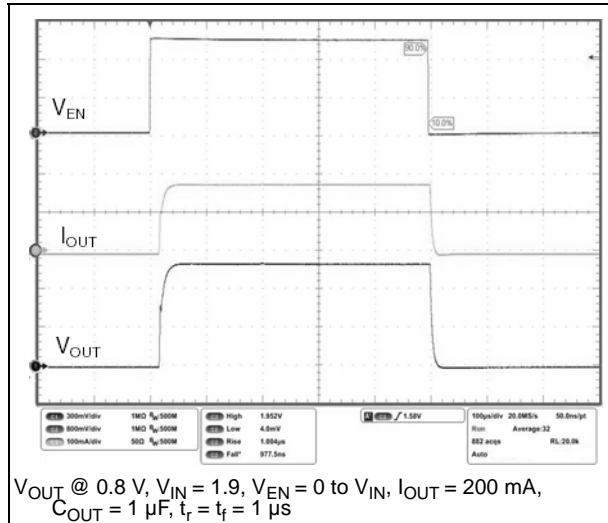

Figure 33. Enable transient ($V_{OUT} = 3\text{ V}$)

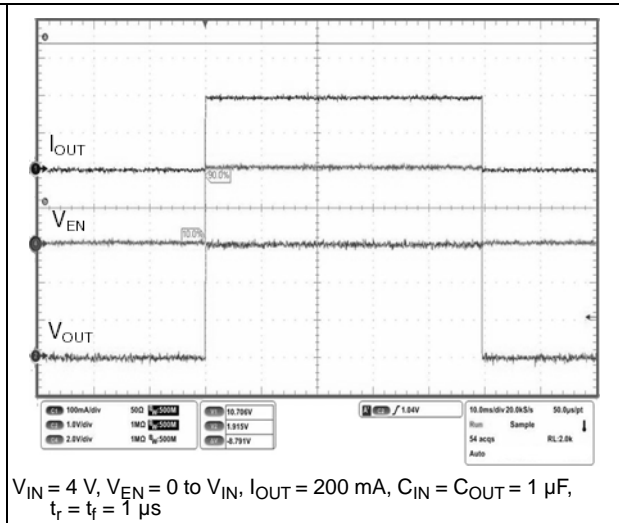

Figure 34. Dropout voltage vs. temperature ($I_{OUT} = 100\text{ mA}$)

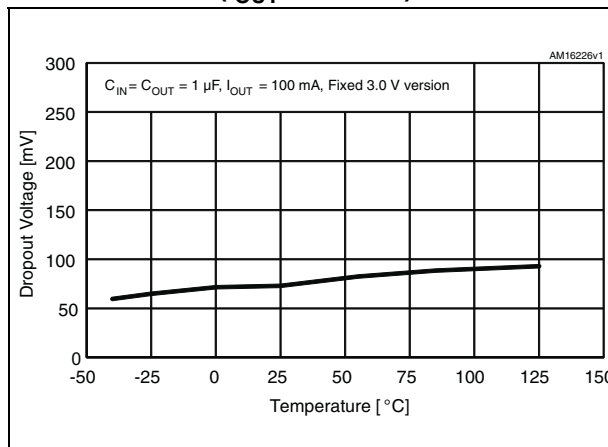
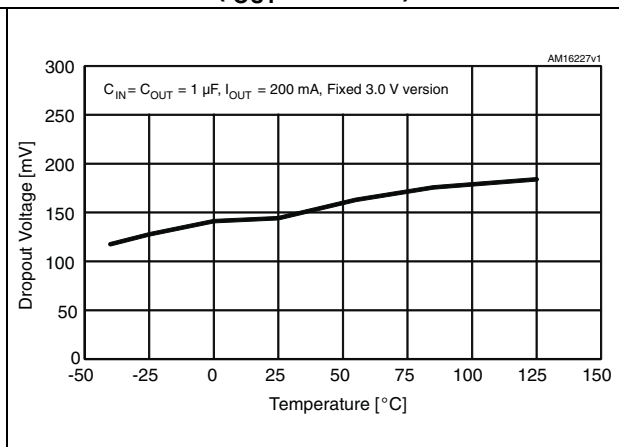

Figure 35. Dropout voltage vs. temperature ($I_{OUT} = 200\text{ mA}$)



7 Package mechanical data

In order to meet environmental requirements, ST offers these devices in different grades of ECOPACK® packages, depending on their level of environmental compliance. ECOPACK specifications, grade definitions and product status are available at: www.st.com. ECOPACK is an ST trademark.

Figure 36. SOT23-5L mechanical drawing

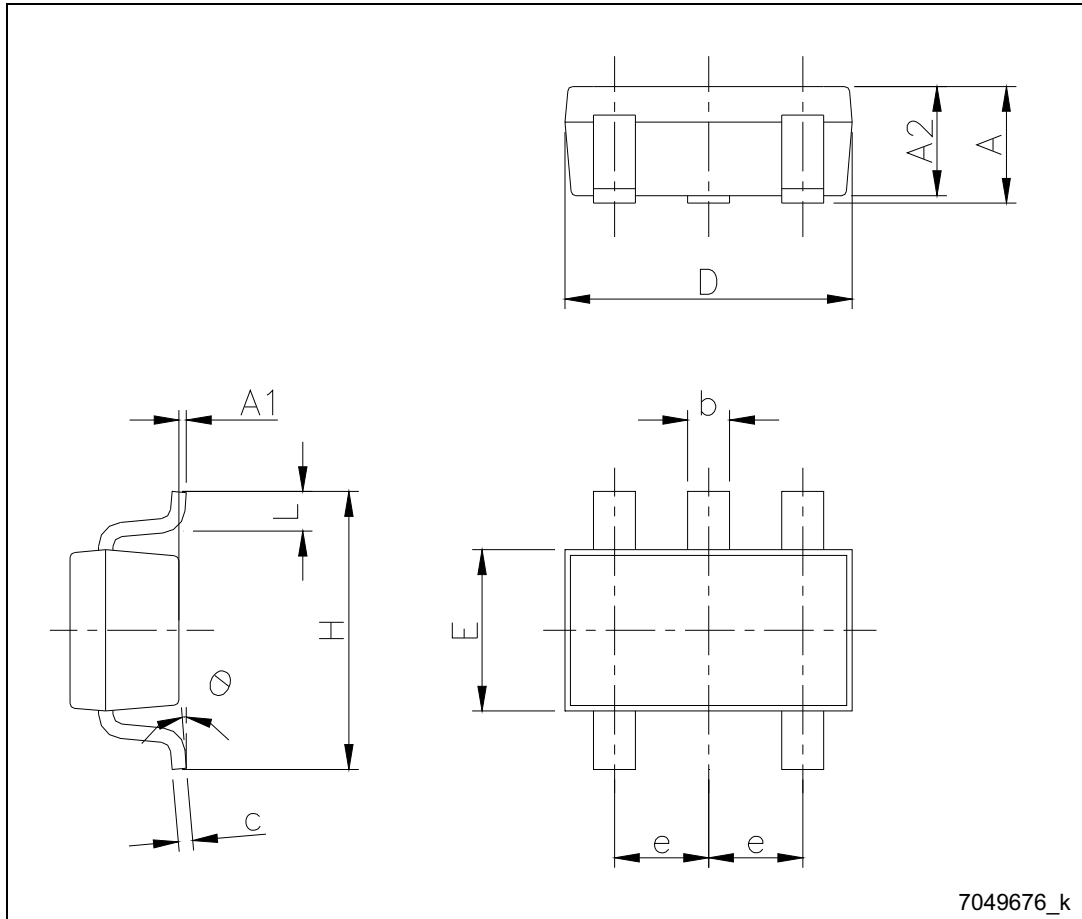

Table 6. SOT23-5L mechanical data

| Dim. | mm | | |
|----------|------|------|------|
| | Min. | Typ. | Max. |
| A | 0.90 | | 1.45 |
| A1 | 0 | | 0.15 |
| A2 | 0.90 | | 1.30 |
| b | 0.30 | | 0.50 |
| c | 0.09 | | 0.20 |
| D | | 2.95 | |
| E | | 1.60 | |
| e | | 0.95 | |
| H | | 2.80 | |
| L | 0.30 | | 0.60 |
| θ | 0 | | 8 |

Figure 37. SOT23-5L footprint (dimensions in mm)

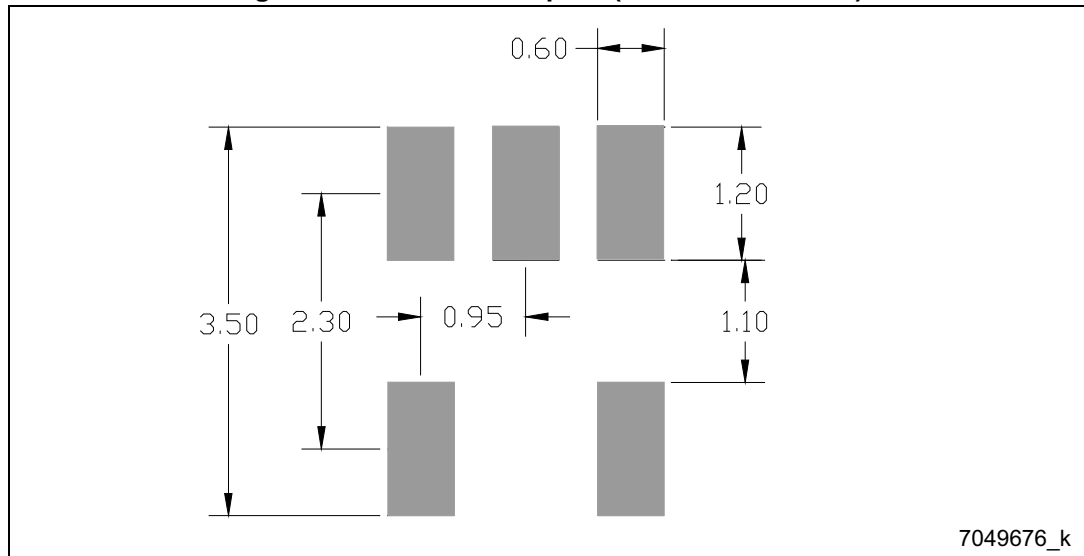
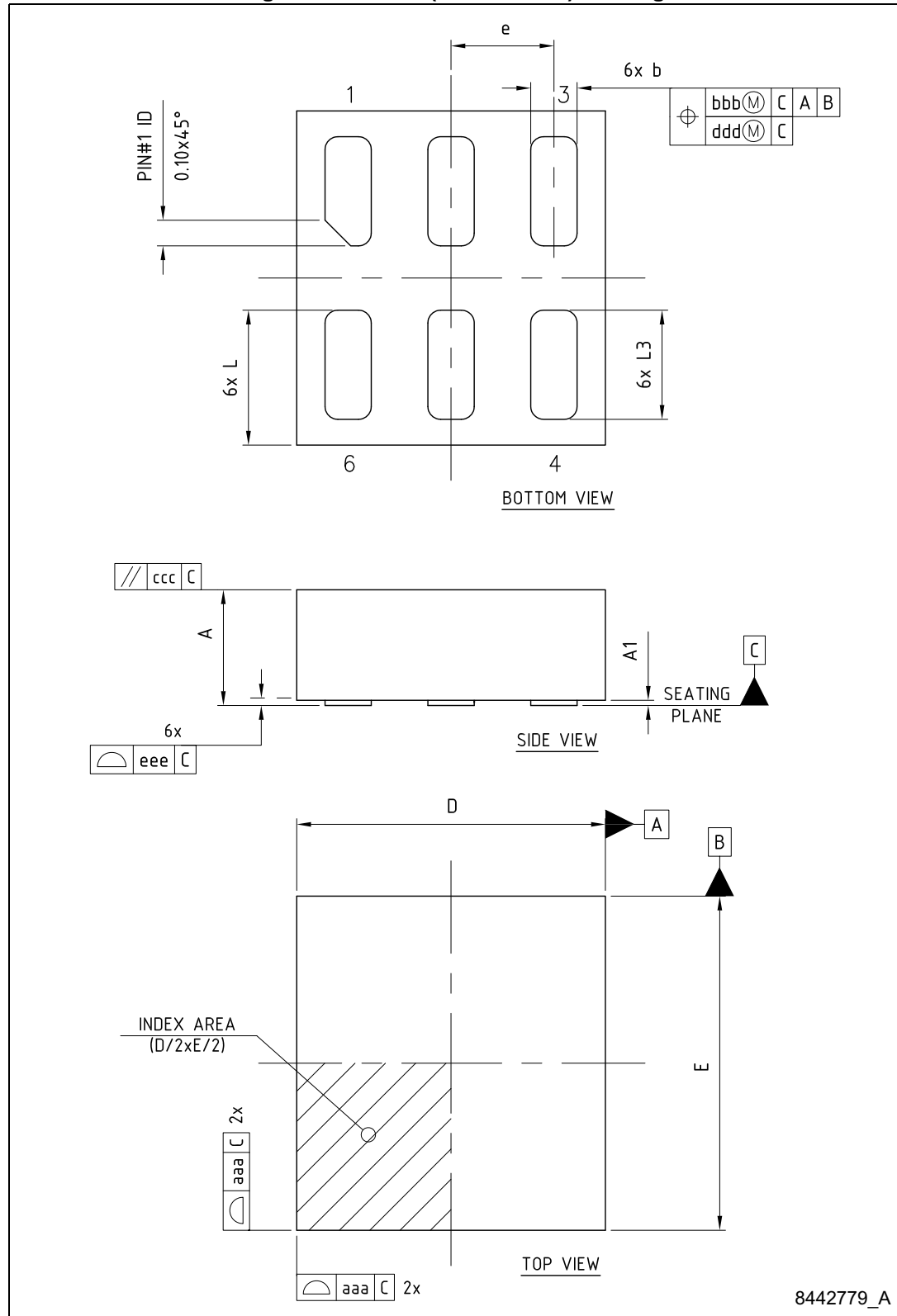

Figure 38. DFN6L (1.2 x 1.3 mm) drawing



8442779_A

Table 7. DFN6L (1.2 x 1.3 mm) mechanical data

| Dim. | mm | | |
|------|-------|-------|-------|
| | Min. | Typ. | Max. |
| A | 0.41 | 0.45 | 0.50 |
| A1 | 0.00 | 0.02 | 0.05 |
| D | - | 1.20 | - |
| E | - | 1.30 | - |
| e | - | 0.40 | - |
| b | 0.15 | 0.18 | 0.25 |
| L | 0.475 | 0.525 | 0.575 |
| L3 | 0.375 | 0.425 | 0.475 |
| aaa | - | 0.05 | - |

Figure 39. DFN6L footprint (dimensions in mm)

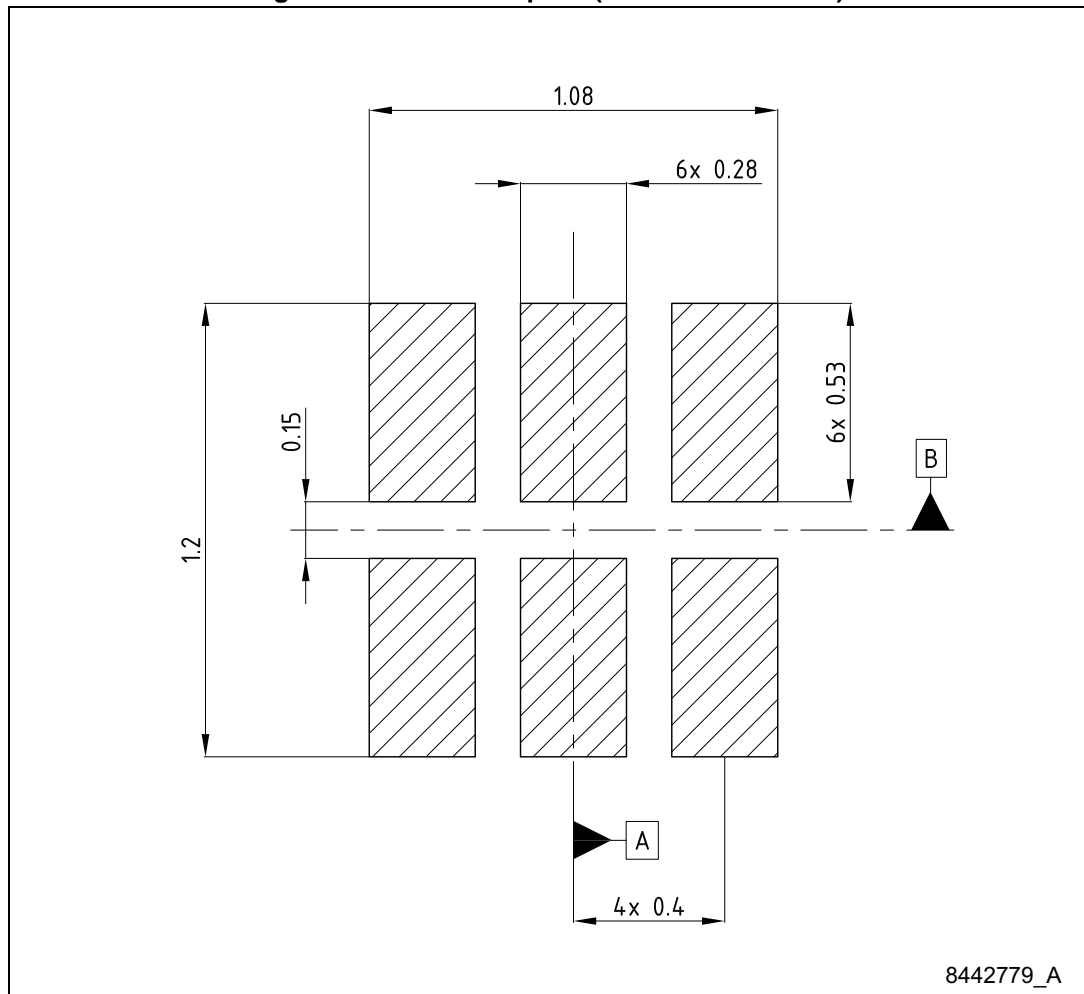

Figure 40. SOT323-5L drawing

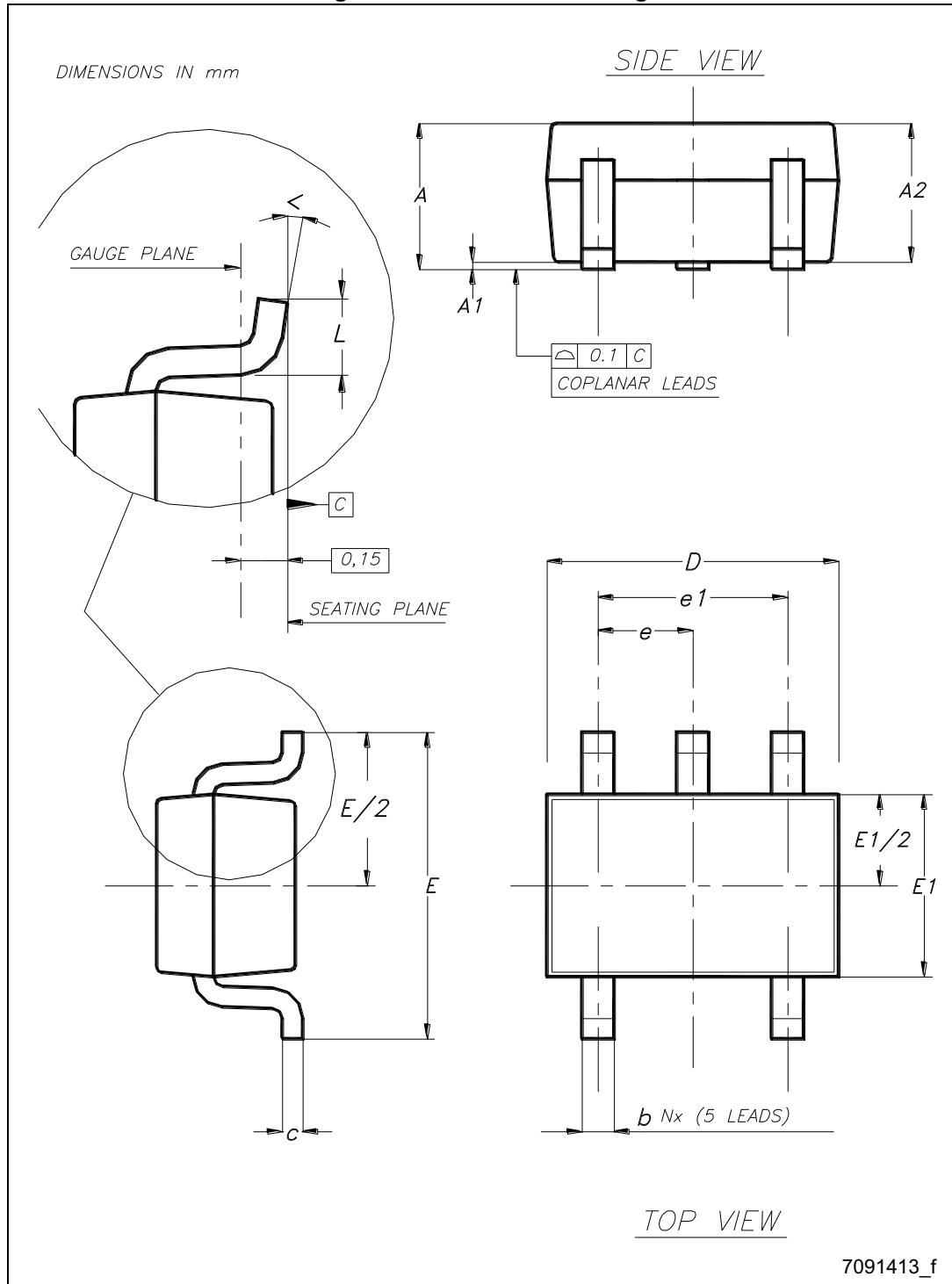

Table 8. SOT323-5L mechanical data

| Dim. | mm | | |
|------|------|------|------|
| | Min. | Typ. | Max. |
| A | 0.80 | | 1.10 |
| A1 | 0 | | 0.10 |
| A2 | 0.80 | 0.90 | 1 |
| b | 0.15 | | 0.30 |
| c | 0.10 | | 0.22 |
| D | 1.80 | 2 | 2.20 |
| E | 1.80 | 2.10 | 2.40 |
| E1 | 1.15 | 1.25 | 1.35 |
| e | | 0.65 | |
| e1 | | 1.30 | |
| L | 0.26 | 0.36 | 0.46 |
| < | 0° | | 8° |

8 Packaging mechanical data

Figure 41. SOT23-5L and SOT323-xL tape and reel drawing

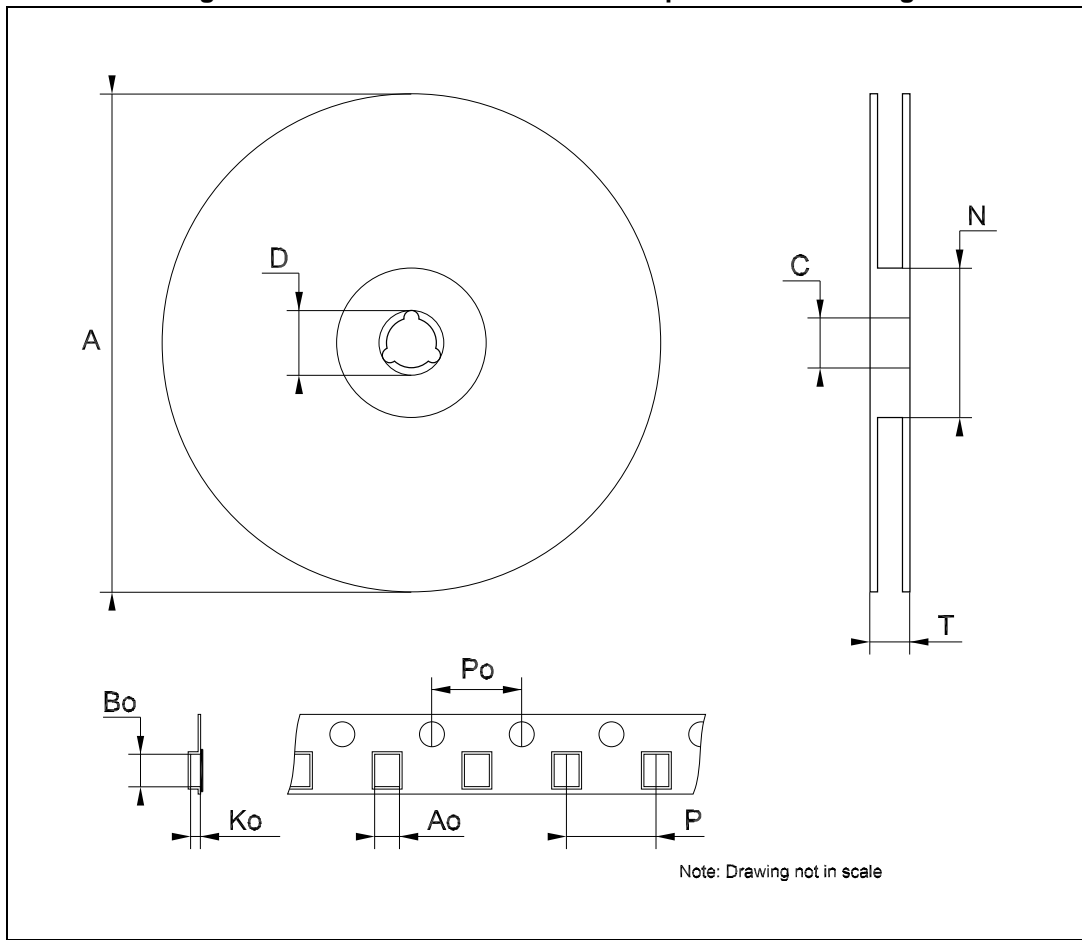

Table 9. SOT23-5L tape and reel mechanical data

| Dim. | mm | | |
|------|------|------|------|
| | Min. | Typ. | Max. |
| A | | | 180 |
| C | 12.8 | 13.0 | 13.2 |
| D | 20.2 | | |
| N | 60 | | |
| T | | | 14.4 |
| Ao | 3.13 | 3.23 | 3.33 |
| Bo | 3.07 | 3.17 | 3.27 |
| Ko | 1.27 | 1.37 | 1.47 |
| Po | 3.9 | 4.0 | 4.1 |
| P | 3.9 | 4.0 | 4.1 |

Table 10. SOT323-xL tape and reel mechanical data

| Dim. | mm | | |
|------|------|------|------|
| | Min. | Typ. | Max. |
| A | 175 | 180 | 185 |
| C | 12.8 | 13 | 13.2 |
| D | 20.2 | | |
| N | 59.5 | 60 | 60.5 |
| T | | | 14.4 |
| Ao | | 2.25 | |
| Bo | | 3.17 | |
| Ko | | 1.2 | |
| Po | 3.9 | 4.0 | 4.1 |
| P | 3.9 | 4.0 | 4.2 |

9 Order codes

Table 11. Order codes

| Package | | | Output voltage |
|------------|-------------|-------------|----------------|
| SOT323-5L | SOT23-5L | DFN6L | |
| LDK120C-R | LDK120M-R | LDK120PU-R | ADJ |
| LDK120C08R | LDK120M08R | LDK120PU08R | 0.8 V |
| LDK120C10R | LDK120M10R | LDK120PU10R | 1.0 V |
| LDK120C11R | LDK120M11R | | 1.1 V |
| LDK120C12R | LDK120M12R | LDK120PU12R | 1.2 V |
| LDK120C15R | LDK120M15R | | 1.5 V |
| LDK120C18R | LDK120M18R | LDK120PU18R | 1.8 V |
| LDK120C25R | LDK120M25R | LDK120PU25R | 2.5 V |
| LDK120C28R | LDK120M28R | | 2.8 V |
| LDK120C29R | LDK120M29R | LDK120PU29R | 2.9 V |
| LDK120C30R | LDK120M30R | LDK120PU30R | 3.0 V |
| LDK120C31R | LDK120M31R | | 3.1 V |
| LDK120C32R | LDK120M32R | LDK120PU32R | 3.2 V |
| | LDK120DM33R | | 3.3 V |
| LDK120C33R | LDK120M33R | LDK120PU33R | 3.3 V |
| LDK120C35R | | | 3.5 V |

Table 12. Marking

| Order codes | Package | Output voltage | Marking |
|-------------|-----------|----------------|---------|
| LDK120DMxxR | SOT23-5L | xx V | Dxx |
| LDK120MxxR | SOT23-5L | xx V | Kxx |
| LDK120CxxR | SOT323-5L | xx V | Kxx |
| LDK120PUxxR | DFN-6L | xx V | xx |
| LDK120M-R | SOT23-5L | Adj | KAD |
| LDK120C-R | SOT323-5L | Adj | KAD |
| LDK120PU-R | DFN-6L | Adj | AD |

10 Revision history

Table 13. Document revision history

| Date | Revision | Changes |
|-------------|----------|---|
| 26-Nov-2012 | 1 | Initial release |
| 31-Jan-2013 | 2 | Added new part number LDK120PU32R Updated Table 11: Order codes |
| 18-Oct-2013 | 3 | RPN LDK120xx changed to LDK120. Updated the Features and the Description in cover page. Cancelled Table1: Device summary. Updated Section 7: Package mechanical data, Table 2: Absolute maximum ratings and Table 11: Order codes. Added Section 8: Packaging mechanical data.. Minor text changes. |
| 10-Mar-2014 | 4 | Updated Table 11: Order codes. |
| 29-Apr-2014 | 5 | Updated Table 1: Pin description (SOT23-5L, SOT323-5L), Table 4: Electrical characteristics for LDK120 (fixed version), Table 5: Electrical characteristics for LDK120 (adjustable version), Table 11: Order codes and Table 12: Marking. Added Figure 4: Typical application circuits for D version. Minor text changes. |
| 29-Aug-2014 | 6 | Updated Table 6: SOT23-5L mechanical data and Table 11: Order codes. |
| 07-Oct-2014 | 7 | Updated Table 11: Order codes. Minor text changes. |
| 19-Jan-2018 | 8 | Updated: <i>Figure 23: Output noise vs. frequency ($V_O = 2.5 V$)</i> and <i>Figure 24: Output noise vs. frequency ($V_O = V_{ADJ}$)</i> . |