

DATA SHEET

**ELECTROSTATIC DISCHARGE
PROTECTION DEVICES**

INDUSTRIAL / CONSUMER

SDD52C05L01

RoHS compliant & Halogen free



Product specification – March 20, 2021 V.2

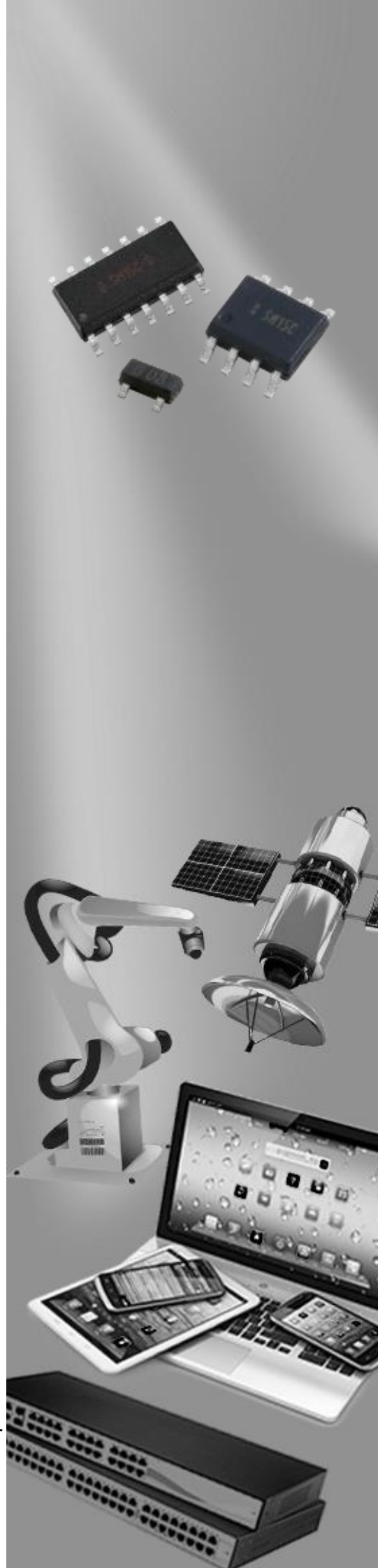

Electrostatic Discharged Protection Devices (ESD) Data Sheet

Description

The SDD52C05L01 is designed to protect voltage sensitive components from ESD and transient voltage events. Excellent clamping capability, low leakage, and fast response time, make these parts ideal for ESD protection on designs where board space is at a premium. Because of its small size, it is suited for use in cellular phones, portable devices, digital cameras, power supplies and many other portable applications. It is designed to protect sensitive semiconductor components from damage or upset due to electrostatic discharge(ESD), electrical fast transients(EFT), and cable discharge events(CDE).



Contact : ±30kV
Air : ±30kV



Features

- IEC61000-4-2 ESD 30KV Air, 30KV contact compliance
- SOD-523 surface mount package
- Working voltage: 5V
- Low leakage current
- Lead Free/RoHS compliant
- Flammability rating UL 94V-0
- Meets MSL level 1, per J-STD-020
- Marking: 5C

Applications

- Cellular handsets & Accessories
- Cordless phones
- Personal digital assistants (PDAs)
- Notebooks & Handhelds
- Portable instrumentation
- Digital cameras
- Peripherals
- MP3 players

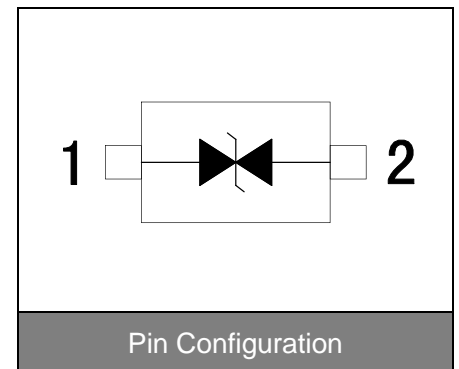

Maximum Ratings

Rating	Symbol	Value	Unit
ESD voltage (Contact discharge)	V_{ESD}	±30	kV
ESD voltage (Air discharge)		±30	
Storage & operating temperature range	T_{STG}, T_J	-55~+150	°C

Electrical Characteristics (T_J=25°C)

Parameter	Symbol	Condition	Min.	Typ.	Max.	Unit
Reverse stand-off voltage	V _{RWM}				5.0	V
Reverse breakdown voltage	V _{BR}	I _{BR} =1.0mA	6.0			V
Reverse leakage current	I _R	V _R =5.0V			1.0	μA
Clamping voltage (tp=8/20μs)	V _C	I _{PP} =20A		20		V
Peak pulse current (tp=8/20μs)	I _{PP}				20	A
Off state junction capacitance	C _J	0Vdc,f=1MHz		30		pF

Typical Characteristics Curves

Figure 1. Pulse Waveform

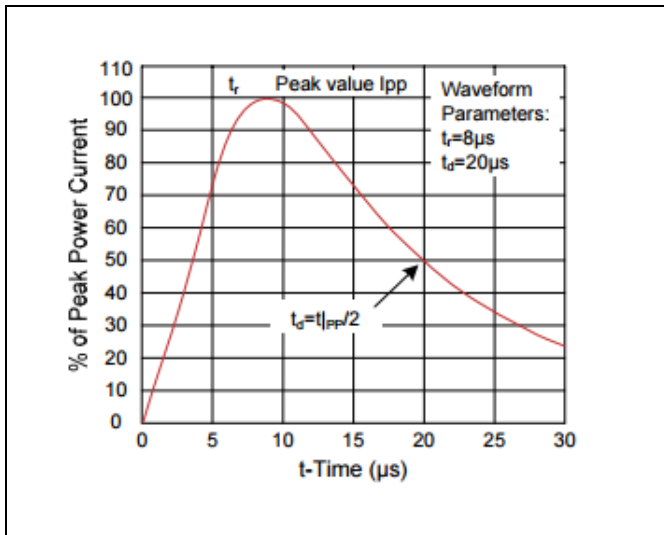

Figure 2. Clamping Voltage vs. Peak Pulse Current

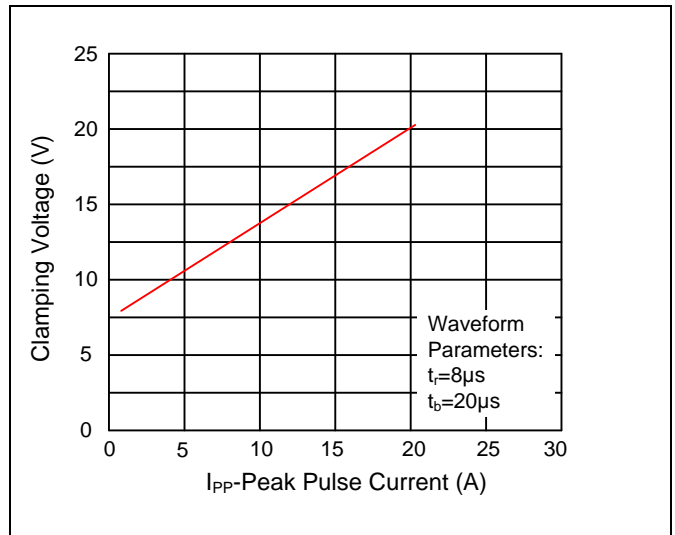

Figure 3. Capacitance vs. Reverse Voltage

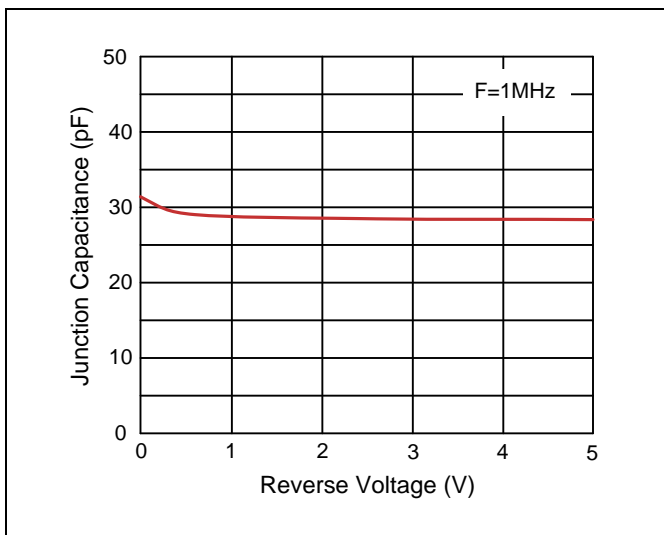
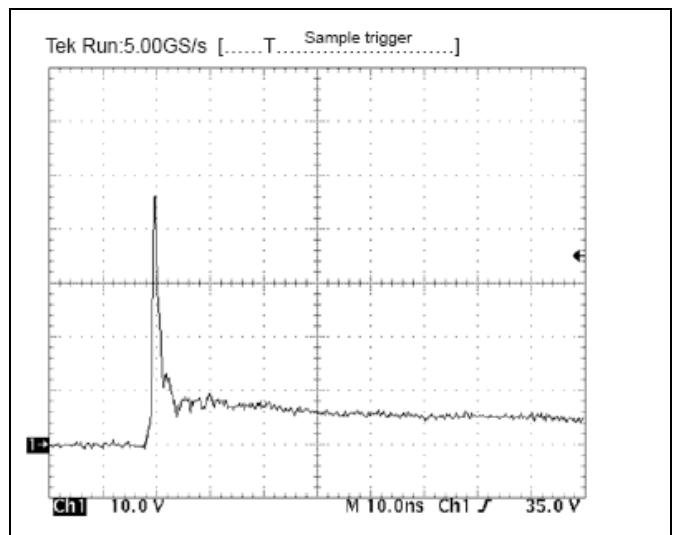
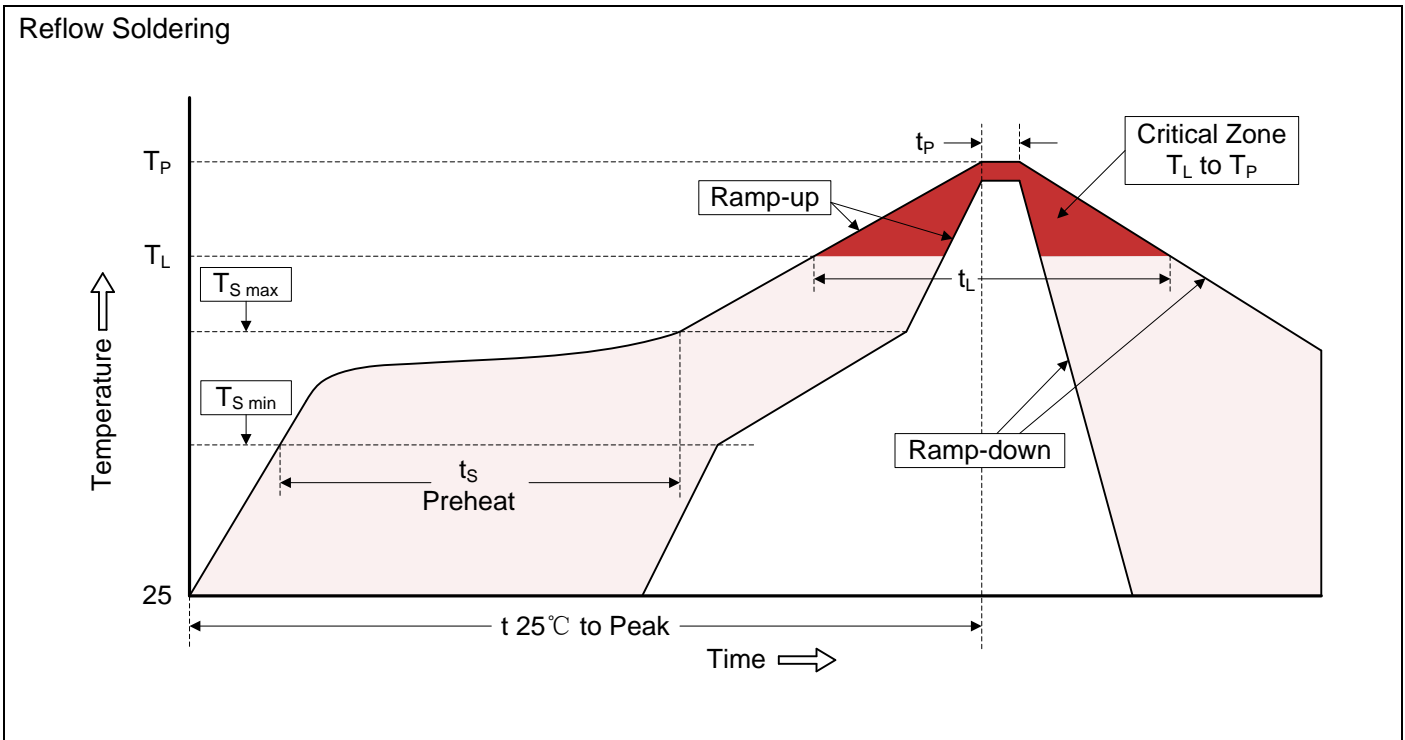

Figure 4. ESD Clamping(8kV Contact IEC61000-4-2)



Recommended Soldering Conditions



Recommended Conditions

Profile Feature	Pb-Free Assembly
Average ramp-up rate (T_L to T_P)	3°C/second max.
Preheat -Temperature Min ($T_{S\ min}$) -Temperature Max ($T_{S\ max}$) -Time (min to max) (t_s)	150°C 200°C 60-180 seconds
$T_{S\ max}$ to T_L -Ramp-up Rate	3°C/second max.
Time maintained above: -Temperature (T_L) -Time (t_L)	217°C 60-150 seconds
Peak Temperature (T_P)	260°C
Time within 5°C of actual Peak Temperature (t_P)	20-40 seconds
Ramp-down Rate	6°C/second max.
Time 25°C to Peak Temperature	8 minutes max.