

Ultra High Dynamic Range

Monolithic Amplifier

LHA-1H+

50Ω 0.05 to 6 GHz

The Big Deal

- Ultra High IP3
- Broadband High Dynamic Range without external Matching Components



Generic photo used for illustration purposes only

MCLP PACKAGE

Product Overview

LHA-1H+ (RoHS compliant) is an advanced wideband amplifier fabricated using E-PHEMT technology and offers extremely high dynamic range over a broad frequency range and with low noise figure. In addition, the LHA-1H+, unlike competitive models, is well matched (input and output) over a broad frequency range without the need for external matching components. It is enclosed in a 3x3 mm MCLP package for low parasitic interface.

Key Features

Feature	Advantages
Broad Band: 0.05 to 6.0 GHz	Broadband covering primary wireless communications bands: Cellular, PCS, LTE, WiMAX
Extremely High IP3 versus DC power Consumption 41 dBm typical at 2 GHz	The LHA-1H+ matches industry leading IP3 performance relative to device size and power consumption. The combination of the design and E-PHEMT Structure provides enhanced linearity over a broad frequency range as evidence in the IP3 being typically 17 dB above the P 1dB point. This feature makes this amplifier ideal for use in: <ul style="list-style-type: none">• Driver amplifiers for complex waveform up converter paths• Drivers in linearized transmit systems• Secondary amplifiers in ultra High Dynamic range receivers
No External Matching Components Required	LHA-1H+ provides Input and Output Return Loss of 10-22 dB up to 4 GHz without the need for any external matching components
Low Noise Figure: 2.7 dB typ. up to 4 GHz 3.3 dB typ. up to 6 GHz	A unique feature of the LHA-1H+ which separates this design from all competitors is the low noise figure performance in combination with the high dynamic range.
Low Junction Temperature: Tj=115°C at 85°C lead temperature and 135°C at 105°C lead temperature	Results in excellent reliability up to 105°C



Ultra High Dynamic Range

Monolithic Amplifier

0.05-6 GHz

Product Features

- High IP3, 41 dBm typ. at 2 GHz, 5V
- Gain, 13.9 dB typ. at 2 GHz, 5V
- High Pout, P1dB 22.5 dBm typ. at 2 GHz, 5V
- Low noise figure, 2.1 dB @2 GHz, 5V
- Usable to 4.0V
- No external matching components required



Generic photo used for illustration purposes only

LHA-1H+

CASE STYLE: FG873

+RoHS Compliant

The +Suffix identifies RoHS Compliance. See our web site for RoHS Compliance methodologies and qualifications

Typical Applications

- Base station infrastructure
- Portable Wireless
- CATV & DBS
- MMDS & Wireless LAN
- LTE

General Description

LHA-1H+ (RoHS compliant) is an advanced wideband amplifier fabricated using E-PHEMT technology and offers extremely high dynamic range over a broad frequency range and with low noise figure. In addition, the LHA-1H+ has well matched input and output over a broad frequency range without the need for external matching components. It has repeatable performance from lot to lot and is enclosed in a 3 x 3 mm MCLP package for low parasitic interface.

simplified schematic and pad description

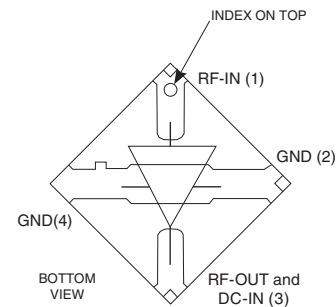
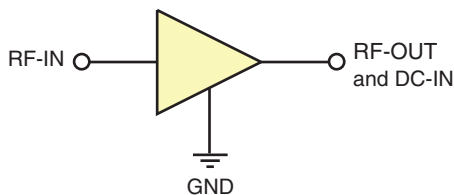

Function	Pad Number	Description
RF-IN	1	RF input pin. This pin requires the use of an external DC blocking capacitor chosen for the frequency of operation.
RF-OUT and DC-IN	3	RF output and bias pin. DC voltage is present on this pin; therefore a DC blocking capacitor is necessary for proper operation. An RF choke is needed to feed DC bias without loss of RF signal due to the bias connection, as shown in "Recommended Application Circuit", Fig. 2
GND	2,4	Connections to ground. Use via holes as shown in "Suggested Layout for PCB Design" to reduce ground path inductance for best performance.



Electrical Specifications¹ at 25°C, unless noted

Parameter	Condition (GHz)	Vd=5.0V			Vd=4.5V	Vd=4.0V	Units
		Min.	Typ.	Max.	Typ.	Typ.	
Frequency Range		0.05-6			0.05-6	0.05-6	GHz
Gain	0.05	16.0	17.7	19.6	17.6	17.3	dB
	0.8	14.4	15.9	17.6	15.7	15.5	
	2.0	—	13.9	—	13.8	13.5	
	3.0	—	12.2	—	12.0	11.7	
	4.0	9.8	10.8	12.0	10.5	10.3	
	6.0	—	8.7	—	8.5	8.2	
Input Return Loss	0.05	—	11.5	—	11.2	10.9	dB
	0.8	13.0	16.2	—	16.0	15.4	
	2.0	—	11.4	—	11.2	10.9	
	3.0	—	10.1	—	10.0	9.7	
	4.0	—	9.7	—	9.8	9.6	
	6.0	—	8.7	—	8.8	8.6	
Output Return Loss	0.05	—	14.6	—	14.5	14.3	dB
	0.8	13.0	22.3	—	22.4	22.0	
	2.0	—	20.1	—	19.4	17.8	
	3.0	—	18.1	—	17.6	16.3	
	4.0	—	16.4	—	16.3	15.5	
	6.0	—	15.4	—	15.0	14.2	
Reverse Isolation	2.0	—	19.2	—	19.1	18.9	dB
Output Power @ 1 dB compression	0.05	20.0	22.7	—	21.4	19.9	dBm
	0.8	20.0	22.6	—	21.4	19.9	
	2.0	20.0	22.5	—	21.3	19.8	
	3.0	—	22.7	—	21.5	19.9	
	4.0	—	22.9	—	21.7	20.0	
	6.0	—	22.2	—	21.1	19.7	
Output IP3	0.05	—	40.3	—	38.5	35.6	dBm
	0.8	38.0	41.2	—	39.6	35.4	
	2.0	—	41.4	—	36.3	32.9	
	3.0	—	40.9	—	35.8	32.3	
	4.0	—	41.0	—	35.8	32.4	
	6.0	—	38.6	—	34.5	31.4	
Noise Figure	0.05	—	1.6	—	1.5	1.5	dB
	0.8	—	1.9	—	1.8	1.8	
	2.0	—	2.1	—	2.0	2.0	
	3.0	—	2.5	—	2.3	2.2	
	4.0	—	2.7	—	2.4	2.3	
	6.0	—	3.3	—	3.1	2.8	
Device Operating Voltage		4.8	5.0	5.2	4.5	4.0	V
Device Operating Current			145	165	116	88	mA
Device Current Variation vs. Temperature ²			109		141	154	µA/°C
Device Current Variation vs Voltage			0.058		0.057	0.055	mA/mV
Thermal Resistance, junction-to-ground lead			36		36	36	°C/W

1. Measured on Mini-Circuits Characterization test board TB-784+. See Characterization Test Circuit (Fig. 1)
 2. (Current at 85°C — Current at -45°C)/130

Absolute Maximum Ratings³

Parameter	Ratings
Operating Temperature (ground lead)	-40°C to 105°C
Storage Temperature	-65°C to 150°C
Operating Current at 5V	210 mA
Power Dissipation	1 W
Input Power (CW)	24 dBm
DC Voltage on Pad 3	6 V

3. Permanent damage may occur if any of these limits are exceeded.
 Electrical maximum ratings are not intended for continuous normal operation.

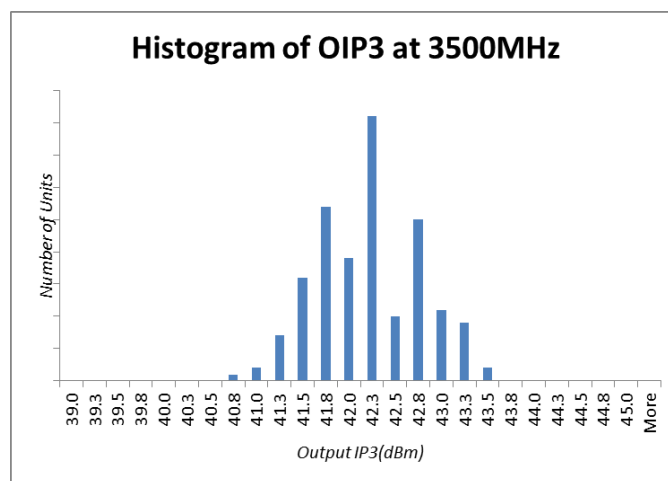
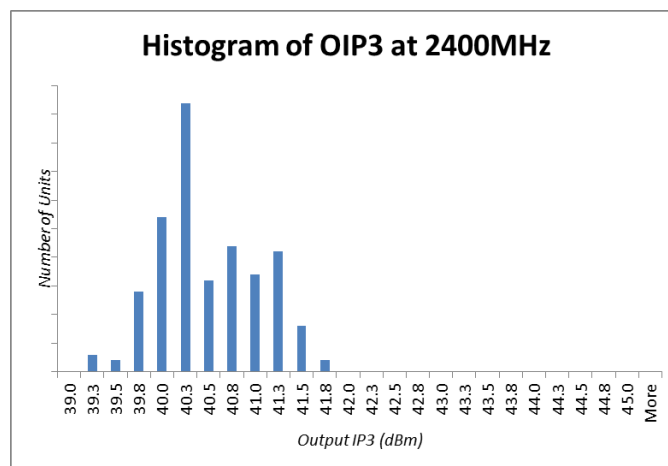
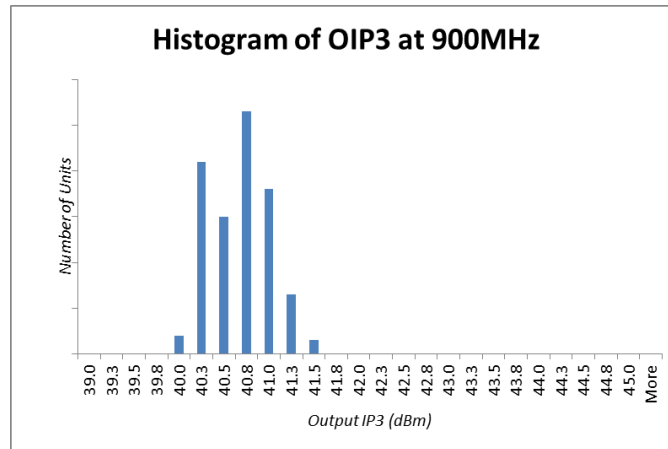

Characterization Test Circuit

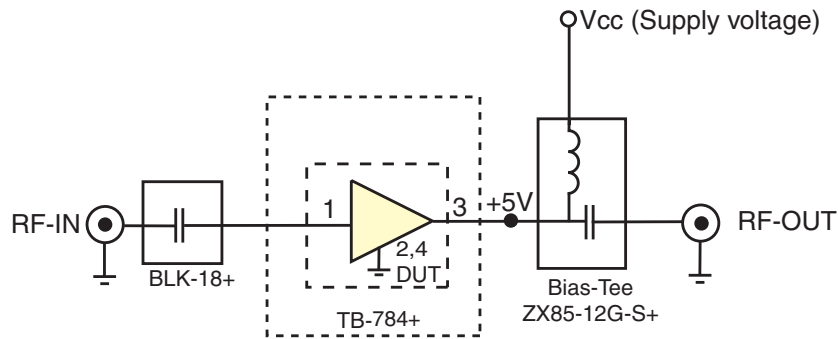

Fig 1. Block Diagram of Test Circuit used for characterization. (DUT soldered on Mini-Circuits Characterization test board TB-784+) Gain, Return loss, Output power at 1dB compression (P1 dB) , output IP3 (OIP3) and noise figure measured using Agilent’s N5242A PNA-X microwave network analyzer.

Conditions:

1. Gain and Return loss: Pin= -25dBm
2. Output IP3 (OIP3): Two tones, spaced 1 MHz apart, 5 dBm/tone at output.

Recommended Application Circuit

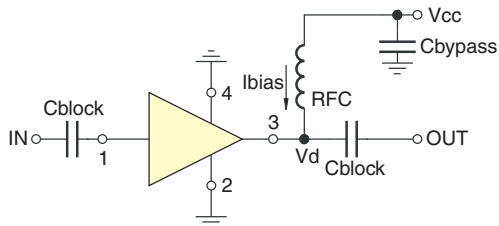

Fig 2. Test Board includes case, connectors, and components soldered to PCB.

Product Marking

