

Specification

Part No.	:	LLP.2500.X.B.30
Description	:	LTCC Low Pass Filter for 2500MHz Bandwidth 100MHz
Features	:	Cutoff Frequency 2450 MHz Low Insertion Loss Low Pass Band Ripple High Attenuation Ultra-Compact, Low Profile SMT Package Dims: 2.9 x 1.25 x 0.95mm

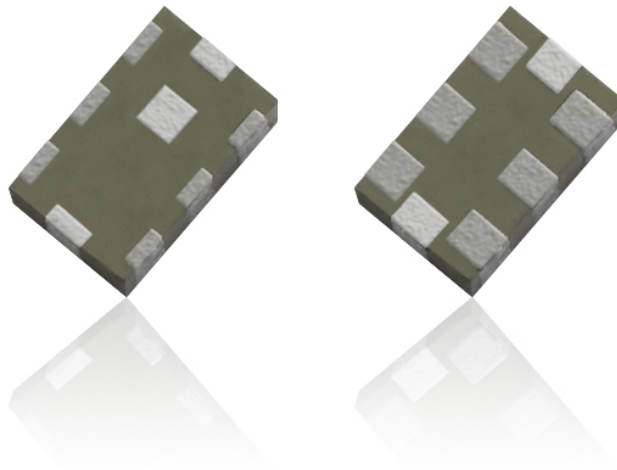

1. Introduction

Taoglas are utilizing their deep understanding of the RF component design and manufacturing process to provide high-quality, small-form-factor, cost-effective and easy to implement RF filters. The Taoglas Filters Division will feature a range of off-the-shelf filters for a variety of applications, including filters for emerging license free bands used for IoT and for GPS L1/L2 and L1/L5 applications. We can also work with customers to develop bespoke filter solutions.

Taoglas LTCC filters are designed to be used in wireless transmitters or receivers. They feature low insertion loss and provide good rejection of unwanted signals at harmonic frequencies for improved system performance. The product is manufactured as a multi-layer monolithic ceramic structure which provides high reliability in a lightweight, low-profile, industrial standard SMT package.

These small part sizes allow for high density PCB layout, provide excellent solderability, and allow for easy visual inspection capability.

The LBP.2500.X.B.30 is a standard Taoglas product but can be customized for specific customer needs. For more information please contact your regional sales office.

2. Specification

ELECTRICAL	
Cutoff Frequency (Fo)	2450 MHz
Insertion Loss	0.5 dB max
Passband Ripple	0.5 dB max
Return Loss	< -10 dB
Attenuation	> 20 dB @ 4500 MHz ~ 5000 MHz > 30dB @ 5000 MHz ~ 8500 MHz
In/Out Impedance	50 Ω
Power Dissipation	1.0 W min.
MECHANICAL	
Dimension	2.9 x 1.25 x 0.95mm (L x W x H)
Material	Ceramic
Finish	Ag plated
ENVIRONMENTAL	
Operating Temperature	-40°C to 85°C
Storage Temperature	-40°C to 85°C
Moisture Sensitivity Level (MSL)	3 (168 Hours)

3. Characteristics Curve

3.1. Pass Band Return & Insertion Loss

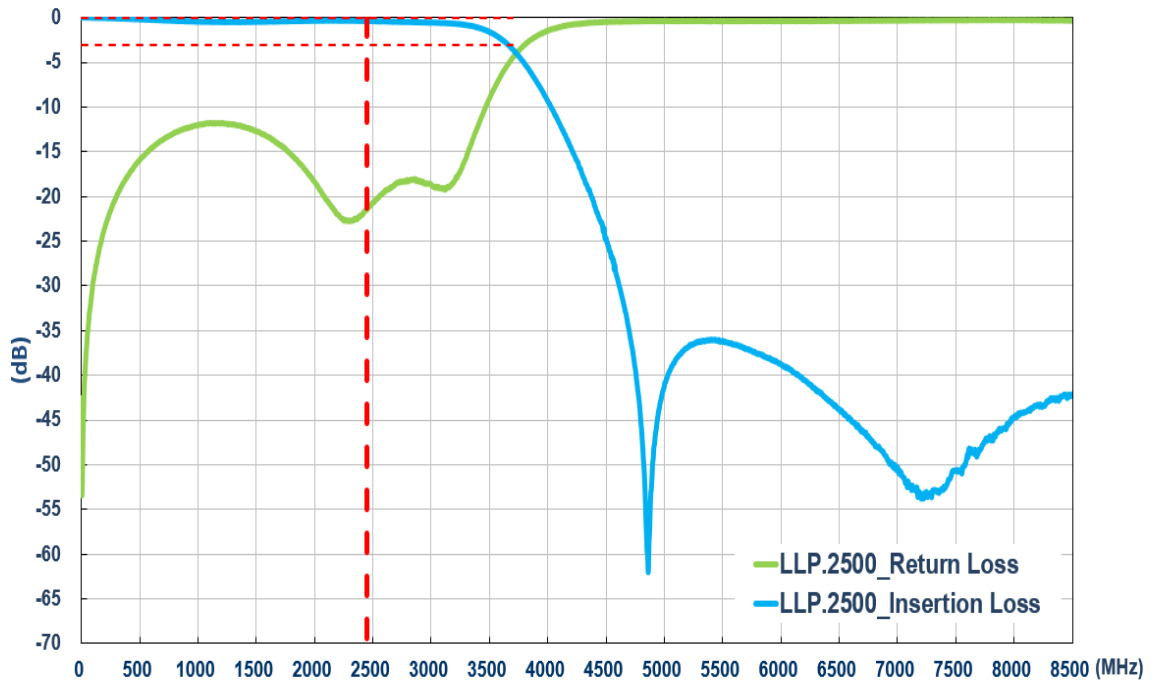

3.2. Out-Of-Band Attenuation

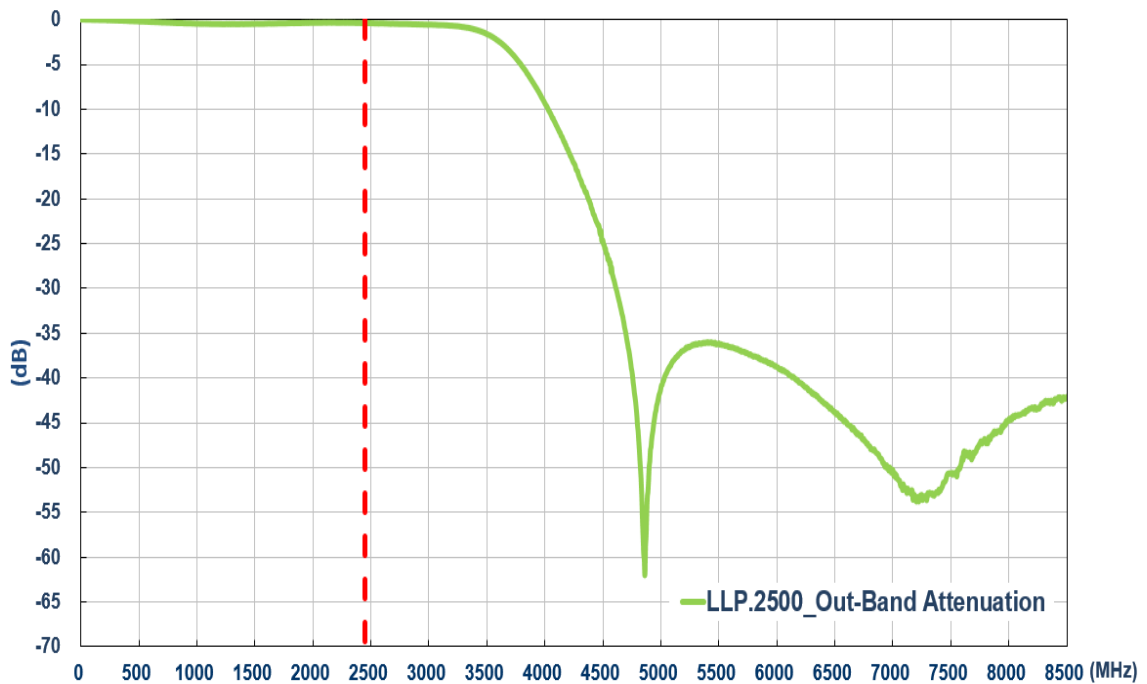

4. Mechanical Drawings (Unit: mm)

4.1. Antenna Drawing

Front View

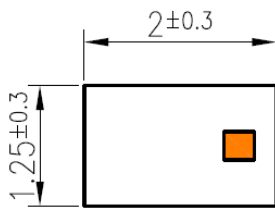

Side View

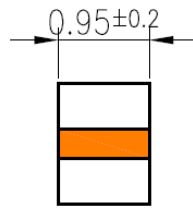

Back View

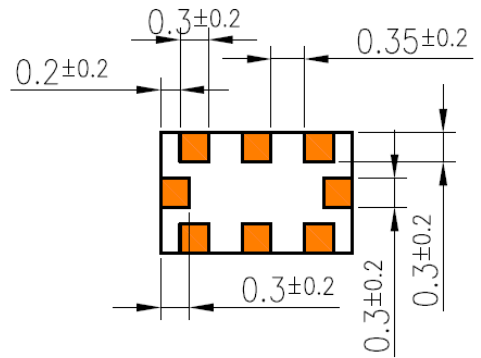

4.2. Recommended PCB Layout

4.2.1. Top Copper

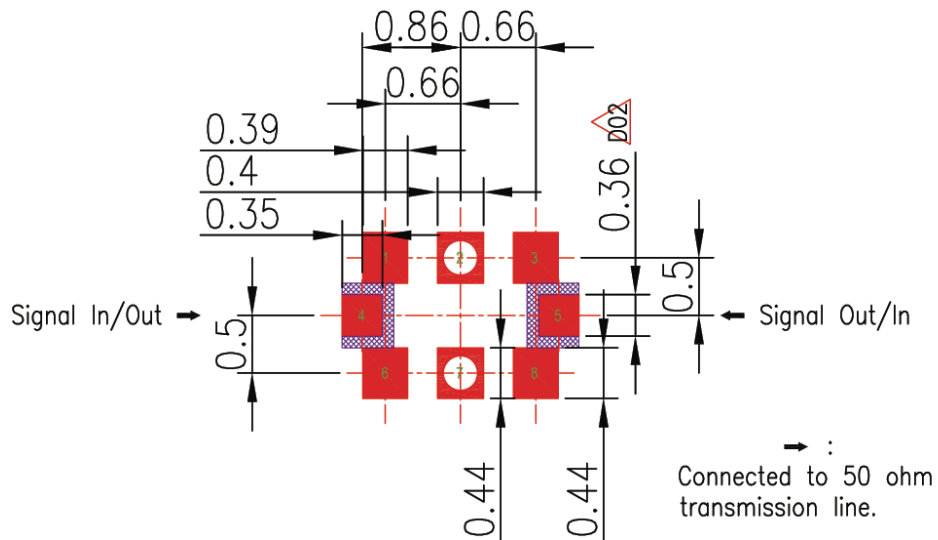

4.2.2. Top Solder Paste

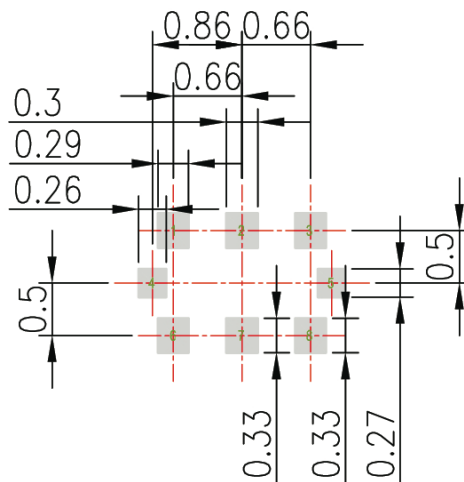

NOTE:

1. Ag Plated area
2. Solder Mask area
3. Copper area
4. Paste area
5. Copper Keepout Area



6. Any vias in pads should be either filled or tented to prevent solder from wicking away from the pad during reflow.
7. The dimension tolerances should follow standard PCB manufacturing guidelines

4.2.3. Top Solder Mask

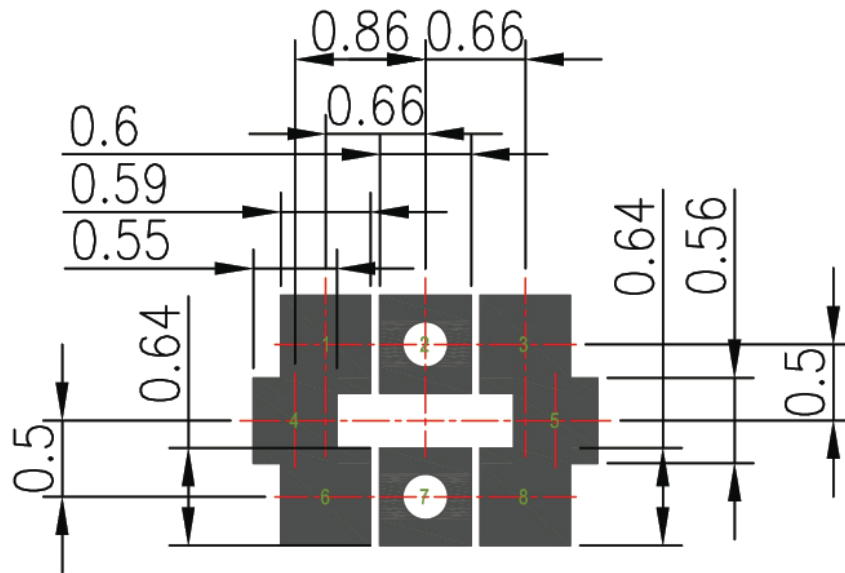

4.2.4. Composite Diagram

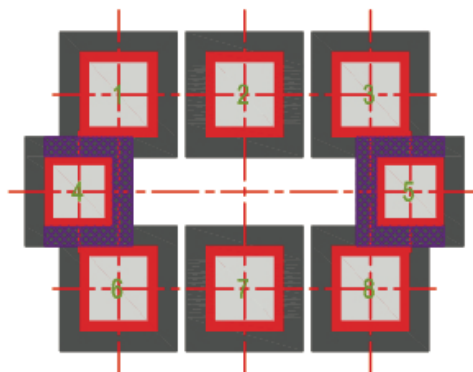

NOTE:

- 1. Ag Plated area
- 2. Solder Mask area
- 3. Copper area
- 4. Paste area
- 5. Copper Keepout Area



- 6. Any vias in pads should be either filled or tented to prevent solder from wicking away from the pad during reflow.
- 7. The dimension tolerances should follow standard PCB manufacturing guidelines

4.3. Evaluation Board

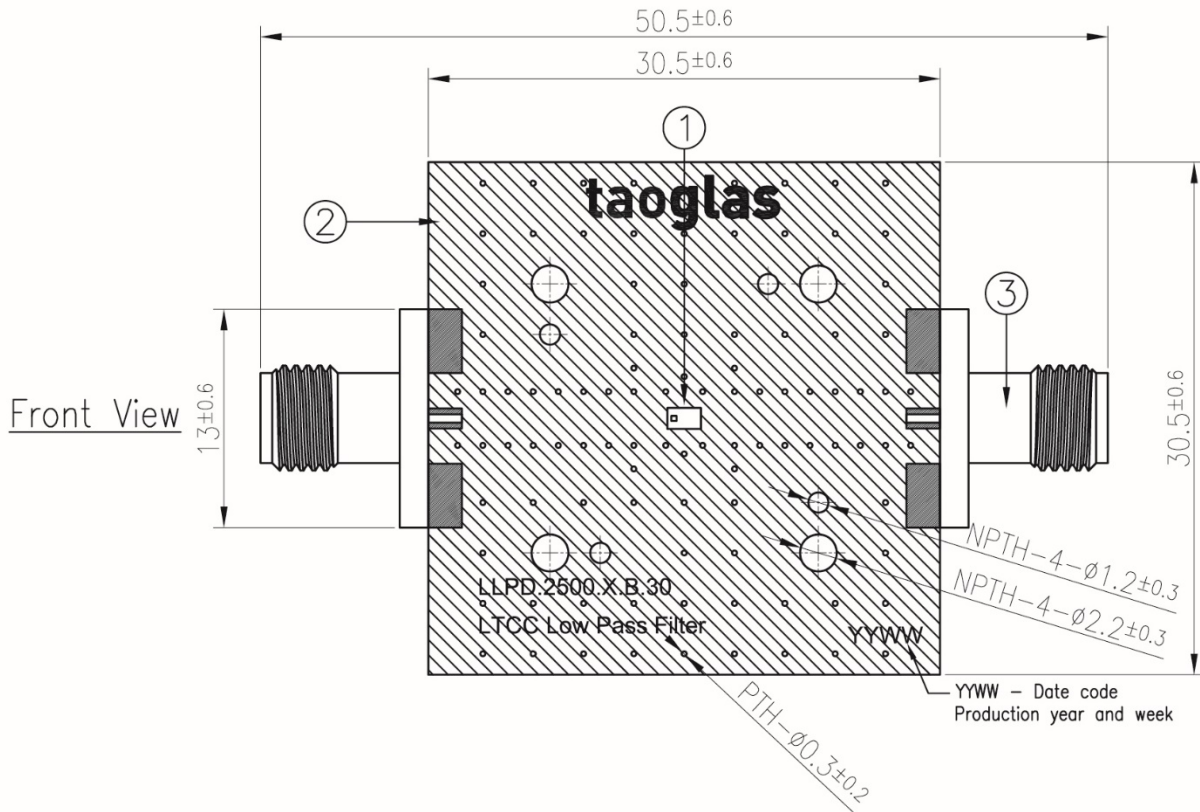

	Name	Material	Finish	QTY
1	Filter (2x1.25x0.95mm)	Ceramic	Clear	1
2	PCB	Composite 1.0t	Black	1
3	SMA(F) ST	Brass	Au Plated	2

5. Recommended Reflow Soldering Profile

Phase	Profile Features	Maximum
Preheat	Temperature Min	150 °C
	Temperature Max	180 °C
	Duration	60-120 sec
Ramp-Up	Avg. Ramp up rate	3 °C/sec (max)
Reflow	Temperature	220 °C
	Duration	30-40 sec
Peak	Temperature	265 °C
	Duration	5 sec Max
Ramp Down	Avg. Ramp down rate	3 °C/sec (max)

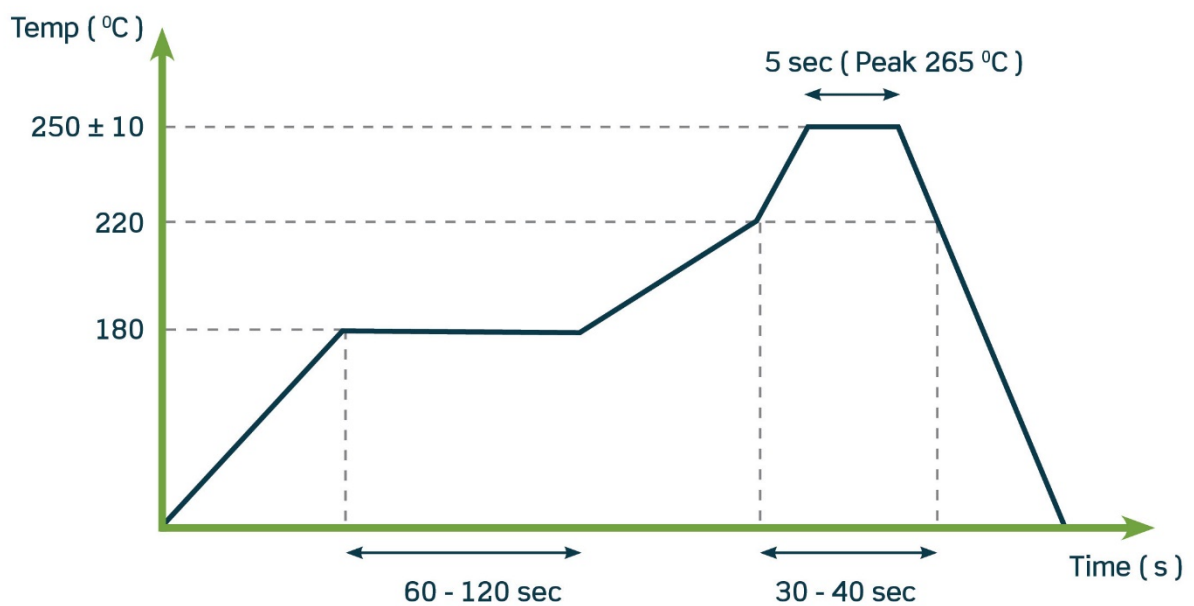

6. Packaging

4000 pc LLP.2500.X.B.30
 1 reel per small inner box
 Dimensions - 178*8.5mm
 Weight - 130g

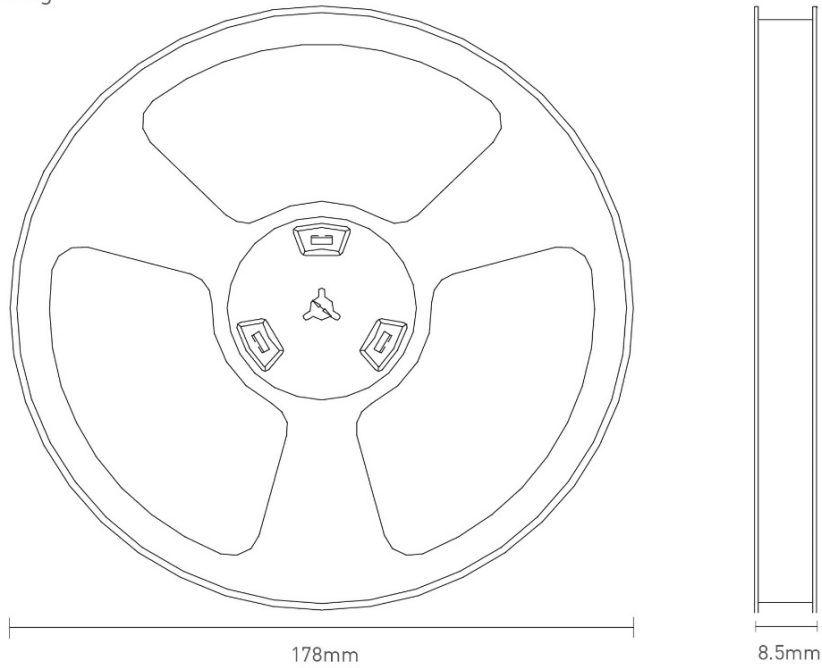

8000 pc LLP.2500.X.B.30
 2 reel in small inner box
 Dimensions - 190*190*28
 Weight - 0.3Kg

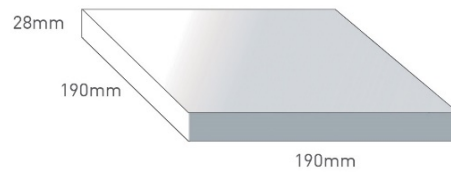

10 inner boxes / 80000 pcs in one carton
 Carton Dimensions - 330*210*210mm
 Weight - 3.3 Kg

