

Micropower Voltage Reference Diodes

LM285, LM385B

The LM285/LM385 series are micropower two-terminal bandgap voltage regulator diodes. Designed to operate over a wide current range of 10 μ A to 20 mA, these devices feature exceptionally low dynamic impedance, low noise and stable operation over time and temperature. Tight voltage tolerances are achieved by on-chip trimming. The large dynamic operating range enables these devices to be used in applications with widely varying supplies with excellent regulation. Extremely low operating current make these devices ideal for micropower circuitry like portable instrumentation, regulators and other analog circuitry where extended battery life is required.

The LM285/LM385 series are packaged in a low cost TO-226 plastic case and are available in two voltage versions of 1.235 V and 2.500 V as denoted by the device suffix (see Ordering Information table). The LM285 is specified over a -40°C to $+85^{\circ}\text{C}$ temperature range while the LM385 is rated from 0°C to $+70^{\circ}\text{C}$.

The LM385 is also available in a surface mount plastic package in voltages of 1.235 V and 2.500 V.

Features

- Operating Current from 10 μ A to 20 mA
- 1.0%, 1.5%, 2.0% and 3.0% Initial Tolerance Grades
- Low Temperature Coefficient
- 1.0 Ω Dynamic Impedance
- Surface Mount Package Available
- These Devices are Pb-Free and are RoHS Compliant

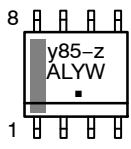

Figure 1. Representative Schematic Diagram

MARKING DIAGRAMS



SOIC-8
D SUFFIX
CASE 751



y85-z
ALYW

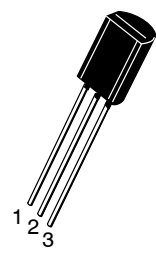

STRAIGHT LEAD

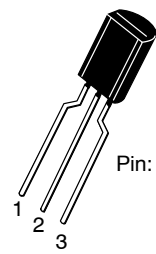

BENT LEAD

Pin: 1. N.C.
2. Cathode
3. Anode

xxx	=	1.2 or 2.5
y	=	2 or 3
z	=	1 or 2
A	=	Assembly Location
L	=	Wafer Lot
Y	=	Year
W	=	Work Week
▪	=	Pb-Free Package

(Note: Microdot may be in either location)

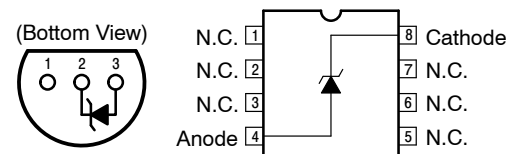

Standard Application

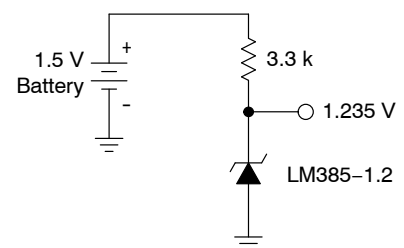

ORDERING INFORMATION

See detailed ordering and shipping information on page 6 of this data sheet.

LM285, LM385B

MAXIMUM RATINGS (T_A = 25°C, unless otherwise noted)

Rating	Symbol	Value	Unit
Reverse Current	I _R	30	mA
Forward Current	I _F	10	mA
Operating Ambient Temperature Range	T _A	-40 to +85 0 to +70	°C
Operating Junction Temperature	T _J	+150	°C
Storage Temperature Range	T _{stg}	-65 to +150	°C
Electrostatic Discharge Sensitivity (ESD) Human Body Model (HBM) Machine Model (MM) Charged Device Model (CDM)	ESD	4000 400 2000	V

Stresses exceeding those listed in the Maximum Ratings table may damage the device. If any of these limits are exceeded, device functionality should not be assumed, damage may occur and reliability may be affected.

ELECTRICAL CHARACTERISTICS (T_A = 25°C, unless otherwise noted)

Characteristic	Symbol	LM285-1.2			LM385-1.2/LM385B-1.2			Unit
		Min	Typ	Max	Min	Typ	Max	
Reverse Breakdown Voltage (I _{Rmin} ≤ I _R ≤ 20 mA) LM285-1.2/LM385B-1.2 T _A = T _{low} to T _{high} (Note 1) LM385-1.2 T _A = T _{low} to T _{high} (Note 1)	V _{(BR)R}	1.223 1.200	1.235 -	1.247 1.270	1.223 1.210	1.235 -	1.247 1.260	V
Minimum Operating Current T _A = 25°C T _A = T _{low} to T _{high} (Note 1)	I _{Rmin}	- -	8.0 -	10 20	- -	8.0 -	15 20	μA
Reverse Breakdown Voltage Change with Current I _{Rmin} ≤ I _R ≤ 1.0 mA, T _A = +25°C T _A = T _{low} to T _{high} (Note 1) 1.0 mA ≤ I _R ≤ 20 mA, T _A = +25°C T _A = T _{low} to T _{high} (Note 1)	ΔV _{(BR)R}	- -	- -	1.0 1.5 10 20	- -	- -	1.0 1.5 20 25	mV
Reverse Dynamic Impedance I _R = 100 μA, T _A = +25°C	Z	-	0.6	-	-	0.6	-	Ω
Average Temperature Coefficient 10 μA ≤ I _R ≤ 20 mA, T _A = T _{low} to T _{high} (Note 1)	ΔV _{(BR)R} /ΔT	-	80	-	-	80	-	ppm/°C
Wideband Noise (RMS) I _R = 100 μA, 10 Hz ≤ f ≤ 10 kHz	n	-	60	-	-	60	-	μV
Long Term Stability I _R = 100 μA, T _A = +25°C ± 0.1°C	S	-	20	-	-	20	-	ppm/kHR
Reverse Breakdown Voltage (I _{Rmin} ≤ I _R ≤ 20 mA) LM285-2.5/LM385B-2.5 T _A = T _{low} to T _{high} (Note 1) LM385-2.5 T _A = T _{low} to T _{high} (Note 1)	V _{(BR)R}	2.462 2.415	2.5 -	2.538 2.585	2.462 2.436	2.5 -	2.538 2.564	V
Minimum Operating Current T _A = 25°C T _A = T _{low} to T _{high} (Note 1)	I _{Rmin}	- -	13 -	20 30	- -	13 -	20 30	μA

- T_{low} = -40°C for LM285-1.2, LM285-2.5
 T_{high} = +85°C for LM285-1.2, LM285-2.5
 T_{low} = 0°C for LM385-1.2, LM385B-1.2, LM385-2.5, LM385B-2.5
 T_{high} = +70°C for LM385-1.2, LM385B-1.2, LM385-2.5, LM385B-2.5

LM285, LM385B

ELECTRICAL CHARACTERISTICS (T_A = 25°C, unless otherwise noted)

Characteristic	Symbol	LM285-1.2			LM385-1.2/LM385B-1.2			Unit
		Min	Typ	Max	Min	Typ	Max	
Reverse Breakdown Voltage Change with Current I _{Rmin} ≤ I _R ≤ 1.0 mA, T _A = +25°C T _A = T _{low} to T _{high} (Note 2) 1.0 mA ≤ I _R ≤ 20 mA, T _A = +25°C T _A = T _{low} to T _{high} (Note 2)	ΔV _{(BR)R}	-	-	1.0	-	-	2.0	mV
		-	-	1.5	-	-	2.5	
		-	-	10	-	-	20	
		-	-	20	-	-	25	
Reverse Dynamic Impedance I _R = 100 μA, T _A = +25°C	Z	-	0.6	-	-	0.6	-	Ω
Average Temperature Coefficient 20 μA ≤ I _R ≤ 20 mA, T _A = T _{low} to T _{high} (Note 2)	ΔV _{(BR)R} /ΔT	-	80	-	-	80	-	ppm/°C
Wideband Noise (RMS) I _R = 100 μA, 10 Hz ≤ f ≤ 10 kHz	n	-	120	-	-	120	-	μV
Long Term Stability I _R = 100 μA, T _A = +25°C ± 0.1°C	S	-	20	-	-	20	-	ppm/kHR

2. T_{low} = -40°C for LM285-1.2, LM285-2.5
 T_{high} = +85°C for LM285-1.2, LM285-2.5
 T_{low} = 0°C for LM385-1.2, LM385B-1.2, LM385-2.5, LM385B-2.5
 T_{high} = +70°C for LM385-1.2, LM385B-1.2, LM385-2.5, LM385B-2.5

LM285, LM385B

TYPICAL PERFORMANCE CURVES FOR LM285-1.2/385-1.2/385B-1.2



Figure 2. Reverse Characteristics

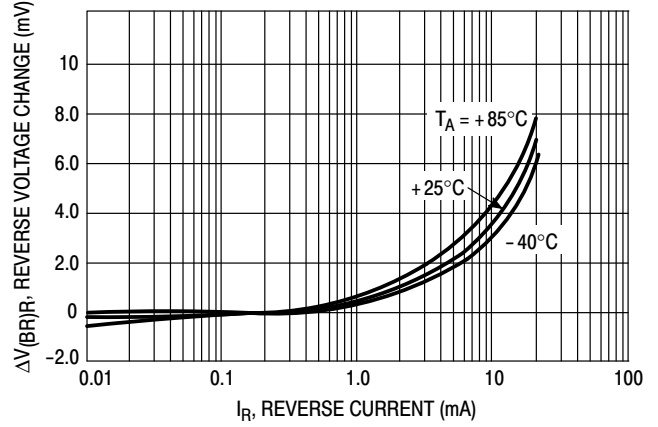

Figure 3. Reverse Characteristics



Figure 4. Forward Characteristics

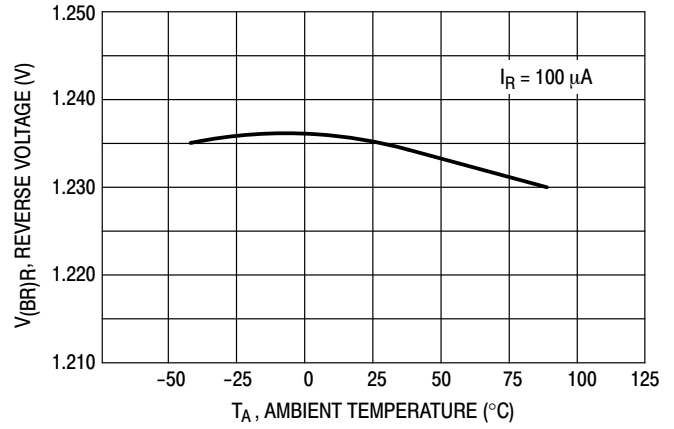

Figure 5. Temperature Drift

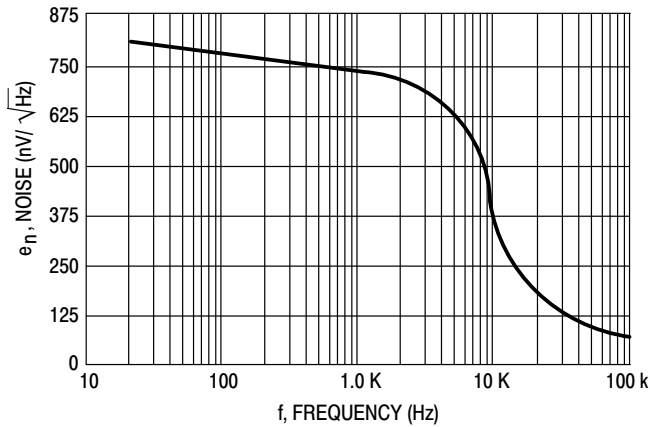

Figure 6. Noise Voltage

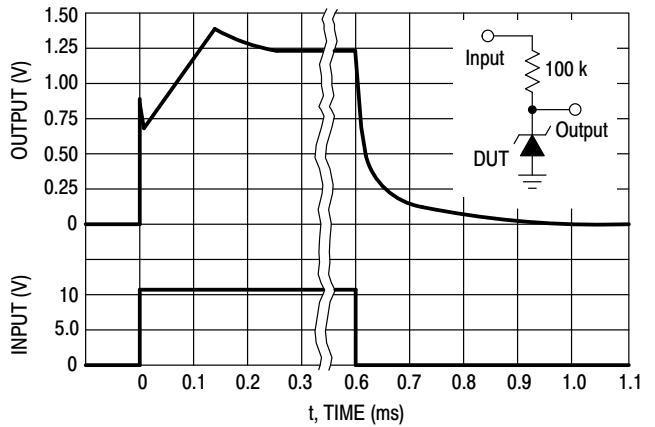

Figure 7. Response Time

LM285, LM385B

TYPICAL PERFORMANCE CURVES FOR LM285-2.5/385-2.5/385B-2.5

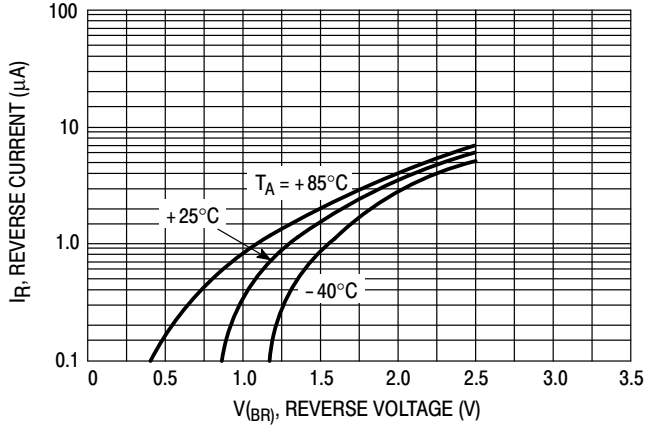

Figure 8. Reverse Characteristics

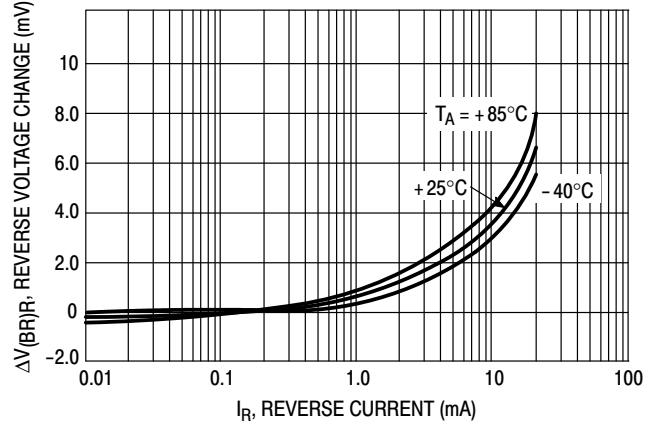

Figure 9. Reverse Characteristics

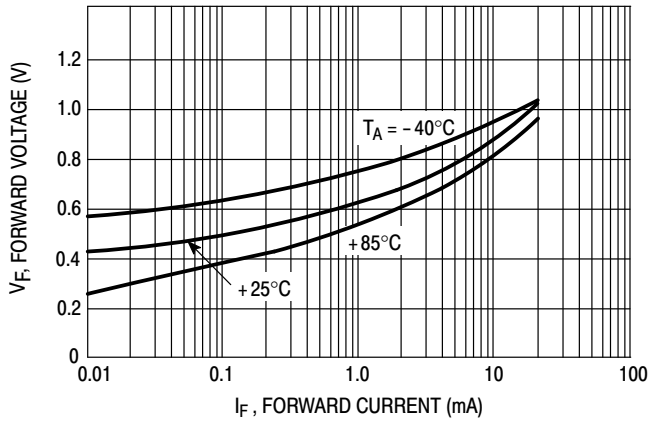

Figure 10. Forward Characteristics

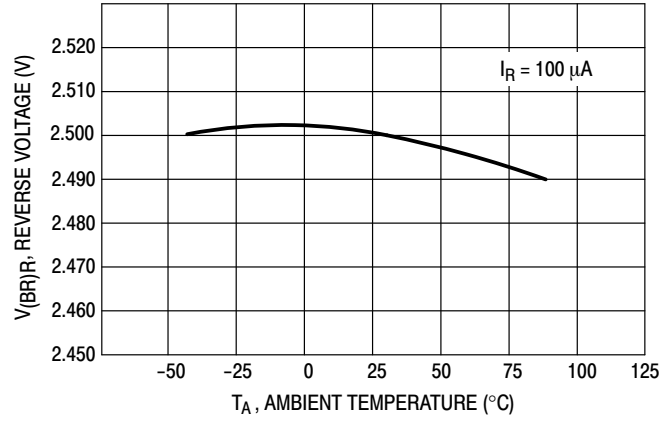

Figure 11. Temperature Drift

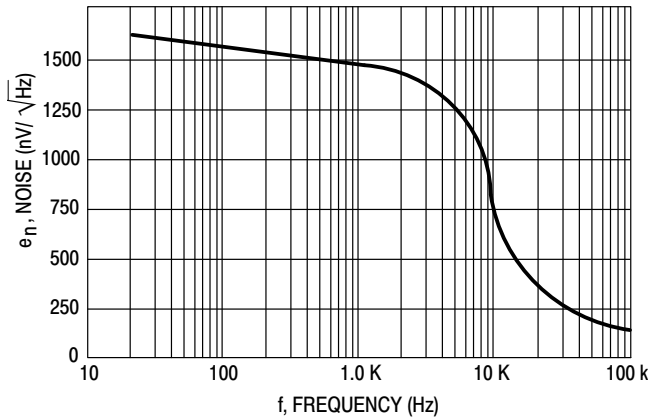

Figure 12. Noise Voltage

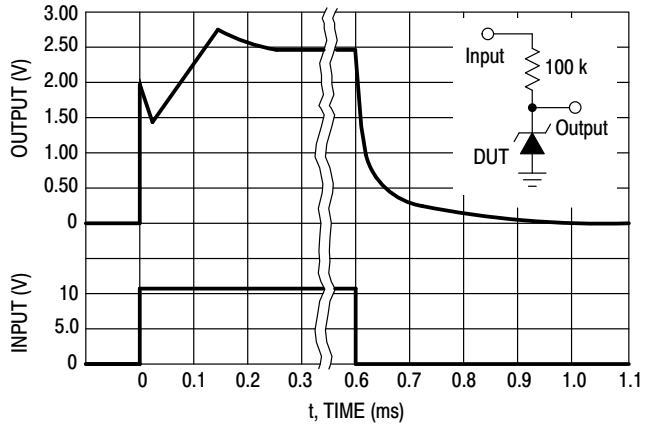

Figure 13. Response Time

LM285, LM385B

ORDERING INFORMATION

Device	Operating Temperature Range	Reverse Break-Down Voltage	Package	Shipping [†]	
LM285D-1.2	T _A = -40°C to +85°C	1.235 V	SOIC-8	98 Units / Rail	
LM285D-1.2G			SOIC-8 (Pb-Free)	98 Units / Rail	
LM285D-1.2R2			SOIC-8	2500 / Tape & Reel	
LM285D-1.2R2G			SOIC-8 (Pb-Free)	2500 / Tape & Reel	
LM285D-2.5		2.500 V	SOIC-8	98 Units / Rail	
LM285D-2.5G			SOIC-8 (Pb-Free)	98 Units / Rail	
LM285D-2.5R2			SOIC-8	2500 / Tape & Reel	
LM285D-2.5R2G			SOIC-8 (Pb-Free)	2500 / Tape & Reel	
LM285Z-1.2		T _A = -40°C to +85°C	1.235 V	TO-92	2000 Units / Bag
LM285Z-1.2G				TO-92 (Pb-Free)	2000 Units / Bag
LM285Z-2.5			2.500 V	TO-92	2000 Units / Bag
LM285Z-2.5G				TO-92 (Pb-Free)	2000 Units / Bag
LM285Z-1.2RA			1.235 V	TO-92	2000 / Tape & Reel
LM285Z-1.2RAG				TO-92 (Pb-Free)	2000 / Tape & Reel
LM285Z-2.5RA			2.500 V	TO-92	2000 / Tape & Reel
LM285Z-2.5RAG				TO-92 (Pb-Free)	2000 / Tape & Reel
LM285Z-2.5RP	TO-92			2000 Units / Fan-Fold	
LM285Z-2.5RPG	TO-92 (Pb-Free)			2000 Units / Fan-Fold	
LM385BD-1.2	T _A = 0°C to +70°C		1.235 V	SOIC-8	98 Units / Rail
LM385BD-1.2G				SOIC-8 (Pb-Free)	98 Units / Rail
LM385BD-1.2R2				SOIC-8	2500 / Tape & Reel
LM385BD-1.2R2G				SOIC-8 (Pb-Free)	2500 / Tape & Reel
LM385BD-2.5			2.500 V	SOIC-8	98 Units / Rail
LM385BD-2.5G				SOIC-8 (Pb-Free)	98 Units / Rail
LM385BD-2.5R2		SOIC-8		2500 / Tape & Reel	
LM385BD-2.5R2G		SOIC-8 (Pb-Free)		2500 / Tape & Reel	
LM385BZ-1.2		1.235 V	TO-92	2000 Units / Bag	
LM385BZ-1.2G			TO-92 (Pb-Free)	2000 Units / Bag	
LM385BZ-1.2RA			TO-92	2000 / Tape & Reel	
LM385BZ-1.2RAG			TO-92 (Pb-Free)	2000 / Tape & Reel	

[†]For information on tape and reel specifications, including part orientation and tape sizes, please refer to our Tape and Reel Packaging Specifications Brochure, BRD8011/D.

LM285, LM385B

ORDERING INFORMATION

Device	Operating Temperature Range	Reverse Break-Down Voltage	Package	Shipping [†]			
LM385BZ-2.5	$T_A = 0^{\circ}\text{C to } +70^{\circ}\text{C}$	2.500 V	TO-92	2000 Units / Bag			
LM385BZ-2.5G			TO-92 (Pb-Free)	2000 Units / Bag			
LM385BZ-2.5RA			TO-92	2000 / Tape & Reel			
LM385BZ-2.5RAG			TO-92 (Pb-Free)	2000 / Tape & Reel			
LM385D-1.2		1.235 V	2.500 V	SOIC-8	98 Units / Rail		
LM385D-1.2G				SOIC-8 (Pb-Free)	98 Units / Rail		
LM385D-1.2R2				SOIC-8	2500 / Tape & Reel		
LM385D-1.2R2G				SOIC-8 (Pb-Free)	2500 / Tape & Reel		
LM385D-2.5		2.500 V	1.235 V	SOIC-8	98 Units / Rail		
LM385D-2.5G				SOIC-8 (Pb-Free)	98 Units / Rail		
LM385D-2.5R2				SOIC-8	2500 / Tape & Reel		
LM385D-2.5R2G				SOIC-8 (Pb-Free)	2500 / Tape & Reel		
LM385Z-1.2		1.235 V	2.500 V	TO-92	2000 Units / Bag		
LM385Z-1.2G				TO-92 (Pb-Free)	2000 Units / Bag		
LM385Z-1.2RA				TO-92	2000 / Tape & Reel		
LM385Z-1.2RAG				TO-92 (Pb-Free)	2000 / Tape & Reel		
LM385Z-1.2RP				TO-92	2000 / Ammo Box		
LM385Z-1.2RPG				TO-92 (Pb-Free)	2000 / Ammo Box		
LM385Z-2.5				2.500 V	1.235 V	TO-92	2000 Units / Bag
LM385Z-2.5G						TO-92 (Pb-Free)	2000 Units / Bag
LM385Z-2.5RP	TO-92	2000 / Ammo Box					
LM385Z-2.5RPG	TO-92 (Pb-Free)	2000 / Ammo Box					

[†]For information on tape and reel specifications, including part orientation and tape sizes, please refer to our Tape and Reel Packaging Specifications Brochure, BRD8011/D.

MECHANICAL CASE OUTLINE
PACKAGE DIMENSIONS



SCALE 1:1

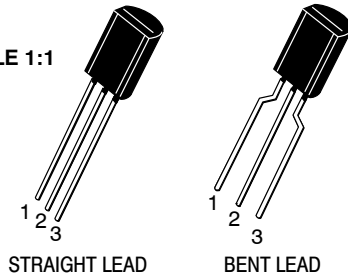

TO-92 (TO-226) 1 WATT
CASE 29-10
ISSUE D

DATE 05 MAR 2021

STRAIGHT LEAD

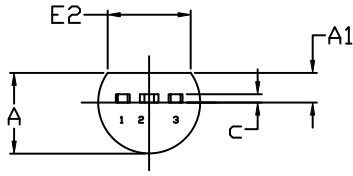

END VIEW

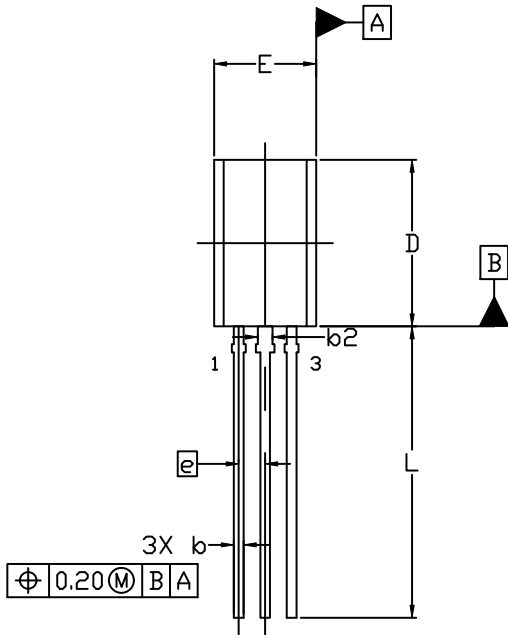

TOP VIEW

NOTES:

1. DIMENSIONING AND TOLERANCING PER ASME Y14.5M, 2009.
2. CONTROLLING DIMENSION: MILLIMETERS
3. DIMENSIONS D AND E DO NOT INCLUDE MOLD FLASH OR GATE PROTRUSIONS.
4. DIMENSION b AND b2 DOES NOT INCLUDE DAMBAR PROTRUSION. LEAD WIDTH INCLUDING PROTRUSION SHALL NOT EXCEED 0.20. DIMENSION b2 LOCATED ABOVE THE DAMBAR PORTION OF MIDDLE LEAD.

DIM	MILLIMETERS		
	MIN.	NOM.	MAX.
A	3.75	3.90	4.05
A1	1.28	1.43	1.58
b	0.38	0.465	0.55
b2	0.62	0.70	0.78
c	0.35	0.40	0.45
D	7.85	8.00	8.15
E	4.75	4.90	5.05
E2	3.90	---	---
e	1.27 BSC		
L	13.80	14.00	14.20

STYLES AND MARKING ON PAGE 3

DOCUMENT NUMBER:	98AON52857E	Electronic versions are uncontrolled except when accessed directly from the Document Repository. Printed versions are uncontrolled except when stamped "CONTROLLED COPY" in red.
DESCRIPTION:	TO-92 (TO-226) 1 WATT	PAGE 1 OF 3

ON Semiconductor and are trademarks of Semiconductor Components Industries, LLC dba ON Semiconductor or its subsidiaries in the United States and/or other countries. ON Semiconductor reserves the right to make changes without further notice to any products herein. ON Semiconductor makes no warranty, representation or guarantee regarding the suitability of its products for any particular purpose, nor does ON Semiconductor assume any liability arising out of the application or use of any product or circuit, and specifically disclaims any and all liability, including without limitation special, consequential or incidental damages. ON Semiconductor does not convey any license under its patent rights nor the rights of others.

TO-92 (TO-226) 1 WATT
CASE 29-10
ISSUE D

DATE 05 MAR 2021

FORMED LEAD



END VIEW

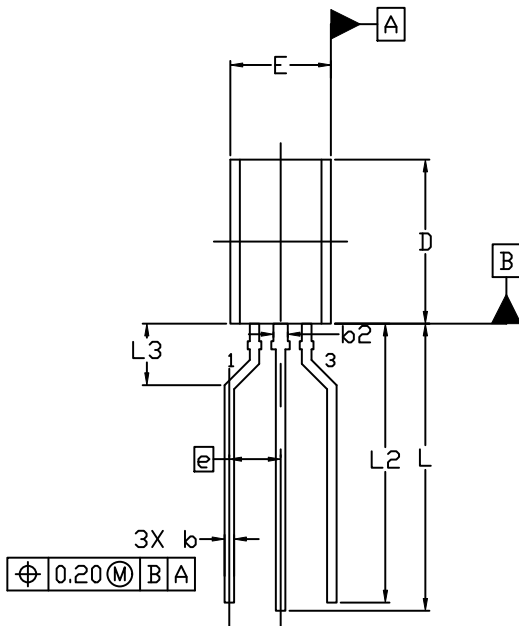

TOP VIEW

NOTES:

1. DIMENSIONING AND TOLERANCING PER ASME Y14.5M, 2009.
2. CONTROLLING DIMENSION: MILLIMETERS
3. DIMENSIONS D AND E DO NOT INCLUDE MOLD FLASH OR GATE PROTRUSIONS.
4. DIMENSION b AND b2 DOES NOT INCLUDE DAMBAR PROTRUSION. LEAD WIDTH INCLUDING PROTRUSION SHALL NOT EXCEED 0.20. DIMENSION b2 LOCATED ABOVE THE DAMBAR PORTION OF MIDDLE LEAD.

DIM	MILLIMETERS		
	MIN.	NOM.	MAX.
A	3.75	3.90	4.05
A1	1.28	1.43	1.58
b	0.38	0.465	0.55
b2	0.62	0.70	0.78
c	0.35	0.40	0.45
D	7.85	8.00	8.15
E	4.75	4.90	5.05
E2	3.90	---	---
e	2.50 BSC		
L	13.80	14.00	14.20
L2	13.20	13.60	14.00
L3	3.00 REF		

STYLES AND MARKING ON PAGE 3

DOCUMENT NUMBER:	98AON52857E	Electronic versions are uncontrolled except when accessed directly from the Document Repository. Printed versions are uncontrolled except when stamped "CONTROLLED COPY" in red.
DESCRIPTION:	TO-92 (TO-226) 1 WATT	PAGE 2 OF 3

ON Semiconductor and  are trademarks of Semiconductor Components Industries, LLC dba ON Semiconductor or its subsidiaries in the United States and/or other countries. ON Semiconductor reserves the right to make changes without further notice to any products herein. ON Semiconductor makes no warranty, representation or guarantee regarding the suitability of its products for any particular purpose, nor does ON Semiconductor assume any liability arising out of the application or use of any product or circuit, and specifically disclaims any and all liability, including without limitation special, consequential or incidental damages. ON Semiconductor does not convey any license under its patent rights nor the rights of others.

**TO-92 (TO-226) 1 WATT
CASE 29-10
ISSUE D**

DATE 05 MAR 2021

- | | | | | |
|---|--|--|---|---|
| STYLE 1:
PIN 1. EMITTER
2. BASE
3. COLLECTOR | STYLE 2:
PIN 1. BASE
2. EMITTER
3. COLLECTOR | STYLE 3:
PIN 1. ANODE
2. ANODE
3. CATHODE | STYLE 4:
PIN 1. CATHODE
2. CATHODE
3. ANODE | STYLE 5:
PIN 1. DRAIN
2. SOURCE
3. GATE |
| STYLE 6:
PIN 1. GATE
2. SOURCE & SUBSTRATE
3. DRAIN | STYLE 7:
PIN 1. SOURCE
2. DRAIN
3. GATE | STYLE 8:
PIN 1. DRAIN
2. GATE
3. SOURCE & SUBSTRATE | STYLE 9:
PIN 1. BASE 1
2. EMITTER
3. BASE 2 | STYLE 10:
PIN 1. CATHODE
2. GATE
3. ANODE |
| STYLE 11:
PIN 1. ANODE
2. CATHODE & ANODE
3. CATHODE | STYLE 12:
PIN 1. MAIN TERMINAL 1
2. GATE
3. MAIN TERMINAL 2 | STYLE 13:
PIN 1. ANODE 1
2. GATE
3. CATHODE 2 | STYLE 14:
PIN 1. EMITTER
2. COLLECTOR
3. BASE | STYLE 15:
PIN 1. ANODE 1
2. CATHODE
3. ANODE 2 |
| STYLE 16:
PIN 1. ANODE
2. GATE
3. CATHODE | STYLE 17:
PIN 1. COLLECTOR
2. BASE
3. EMITTER | STYLE 18:
PIN 1. ANODE
2. CATHODE
3. NOT CONNECTED | STYLE 19:
PIN 1. GATE
2. ANODE
3. CATHODE | STYLE 20:
PIN 1. NOT CONNECTED
2. CATHODE
3. ANODE |
| STYLE 21:
PIN 1. COLLECTOR
2. EMITTER
3. BASE | STYLE 22:
PIN 1. SOURCE
2. GATE
3. DRAIN | STYLE 23:
PIN 1. GATE
2. SOURCE
3. DRAIN | STYLE 24:
PIN 1. EMITTER
2. COLLECTOR/ANODE
3. CATHODE | STYLE 25:
PIN 1. MT 1
2. GATE
3. MT 2 |
| STYLE 26:
PIN 1. V _{CC}
2. GROUND 2
3. OUTPUT | STYLE 27:
PIN 1. MT
2. SUBSTRATE
3. MT | STYLE 28:
PIN 1. CATHODE
2. ANODE
3. GATE | STYLE 29:
PIN 1. NOT CONNECTED
2. ANODE
3. CATHODE | STYLE 30:
PIN 1. DRAIN
2. GATE
3. SOURCE |
| STYLE 31:
PIN 1. GATE
2. DRAIN
3. SOURCE | STYLE 32:
PIN 1. BASE
2. COLLECTOR
3. EMITTER | STYLE 33:
PIN 1. RETURN
2. INPUT
3. OUTPUT | STYLE 34:
PIN 1. INPUT
2. GROUND
3. LOGIC | STYLE 35:
PIN 1. GATE
2. COLLECTOR
3. EMITTER |

**GENERIC
MARKING DIAGRAM***



- XXXX = Specific Device Code
A = Assembly Location
L = Wafer Lot
Y = Year
W = Work Week
▪ = Pb-Free Package

(Note: Microdot may be in either location)

*This information is generic. Please refer to device data sheet for actual part marking. Pb-Free indicator, "G" or microdot "▪", may or may not be present. Some products may not follow the Generic Marking.

DOCUMENT NUMBER:	98AON52857E	Electronic versions are uncontrolled except when accessed directly from the Document Repository. Printed versions are uncontrolled except when stamped "CONTROLLED COPY" in red.
DESCRIPTION:	TO-92 (TO-226) 1 WATT	PAGE 3 OF 3

ON Semiconductor and  are trademarks of Semiconductor Components Industries, LLC dba ON Semiconductor or its subsidiaries in the United States and/or other countries. ON Semiconductor reserves the right to make changes without further notice to any products herein. ON Semiconductor makes no warranty, representation or guarantee regarding the suitability of its products for any particular purpose, nor does ON Semiconductor assume any liability arising out of the application or use of any product or circuit, and specifically disclaims any and all liability, including without limitation special, consequential or incidental damages. ON Semiconductor does not convey any license under its patent rights nor the rights of others.

MECHANICAL CASE OUTLINE PACKAGE DIMENSIONS

ON Semiconductor®



SCALE 1:1

SOIC-8 NB
CASE 751-07
ISSUE AK

DATE 16 FEB 2011



- NOTES:
1. DIMENSIONING AND TOLERANCING PER ANSI Y14.5M, 1982.
 2. CONTROLLING DIMENSION: MILLIMETER.
 3. DIMENSION A AND B DO NOT INCLUDE MOLD PROTRUSION.
 4. MAXIMUM MOLD PROTRUSION 0.15 (0.006) PER SIDE.
 5. DIMENSION D DOES NOT INCLUDE DAMBAR PROTRUSION. ALLOWABLE DAMBAR PROTRUSION SHALL BE 0.127 (0.005) TOTAL IN EXCESS OF THE D DIMENSION AT MAXIMUM MATERIAL CONDITION.
 6. 751-01 THRU 751-06 ARE OBSOLETE. NEW STANDARD IS 751-07.

DIM	MILLIMETERS		INCHES	
	MIN	MAX	MIN	MAX
A	4.80	5.00	0.189	0.197
B	3.80	4.00	0.150	0.157
C	1.35	1.75	0.053	0.069
D	0.33	0.51	0.013	0.020
G	1.27 BSC		0.050 BSC	
H	0.10	0.25	0.004	0.010
J	0.19	0.25	0.007	0.010
K	0.40	1.27	0.016	0.050
M	0°	8°	0°	8°
N	0.25	0.50	0.010	0.020
S	5.80	6.20	0.228	0.244

SOLDERING FOOTPRINT*



SCALE 6:1 (mm/inches)

*For additional information on our Pb-Free strategy and soldering details, please download the ON Semiconductor Soldering and Mounting Techniques Reference Manual, SOLDERRM/D.

GENERIC MARKING DIAGRAM*



XXXXXX = Specific Device Code
 A = Assembly Location
 L = Wafer Lot
 Y = Year
 W = Work Week
 ■ = Pb-Free Package

XXXXXX = Specific Device Code
 A = Assembly Location
 Y = Year
 WW = Work Week
 ■ = Pb-Free Package

*This information is generic. Please refer to device data sheet for actual part marking. Pb-Free indicator, "G" or microdot "•", may or may not be present. Some products may not follow the Generic Marking.

STYLES ON PAGE 2

DOCUMENT NUMBER:	98ASB42564B	Electronic versions are uncontrolled except when accessed directly from the Document Repository. Printed versions are uncontrolled except when stamped "CONTROLLED COPY" in red.
DESCRIPTION:	SOIC-8 NB	PAGE 1 OF 2

ON Semiconductor and ON are trademarks of Semiconductor Components Industries, LLC dba ON Semiconductor or its subsidiaries in the United States and/or other countries. ON Semiconductor reserves the right to make changes without further notice to any products herein. ON Semiconductor makes no warranty, representation or guarantee regarding the suitability of its products for any particular purpose, nor does ON Semiconductor assume any liability arising out of the application or use of any product or circuit, and specifically disclaims any and all liability, including without limitation special, consequential or incidental damages. ON Semiconductor does not convey any license under its patent rights nor the rights of others.

SOIC-8 NB
CASE 751-07
ISSUE AK

DATE 16 FEB 2011

- | | | | |
|--|---|---|---|
| <p>STYLE 1:
 PIN 1. EMITTER
 2. COLLECTOR
 3. COLLECTOR
 4. EMITTER
 5. EMITTER
 6. BASE
 7. BASE
 8. EMITTER</p> | <p>STYLE 2:
 PIN 1. COLLECTOR, DIE, #1
 2. COLLECTOR, #1
 3. COLLECTOR, #2
 4. COLLECTOR, #2
 5. BASE, #2
 6. EMITTER, #2
 7. BASE, #1
 8. EMITTER, #1</p> | <p>STYLE 3:
 PIN 1. DRAIN, DIE #1
 2. DRAIN, #1
 3. DRAIN, #2
 4. DRAIN, #2
 5. GATE, #2
 6. SOURCE, #2
 7. GATE, #1
 8. SOURCE, #1</p> | <p>STYLE 4:
 PIN 1. ANODE
 2. ANODE
 3. ANODE
 4. ANODE
 5. ANODE
 6. ANODE
 7. ANODE
 8. COMMON CATHODE</p> |
| <p>STYLE 5:
 PIN 1. DRAIN
 2. DRAIN
 3. DRAIN
 4. DRAIN
 5. GATE
 6. GATE
 7. SOURCE
 8. SOURCE</p> | <p>STYLE 6:
 PIN 1. SOURCE
 2. DRAIN
 3. DRAIN
 4. SOURCE
 5. SOURCE
 6. GATE
 7. GATE
 8. SOURCE</p> | <p>STYLE 7:
 PIN 1. INPUT
 2. EXTERNAL BYPASS
 3. THIRD STAGE SOURCE
 4. GROUND
 5. DRAIN
 6. GATE 3
 7. SECOND STAGE Vd
 8. FIRST STAGE Vd</p> | <p>STYLE 8:
 PIN 1. COLLECTOR, DIE #1
 2. BASE, #1
 3. BASE, #2
 4. COLLECTOR, #2
 5. COLLECTOR, #2
 6. EMITTER, #2
 7. EMITTER, #1
 8. COLLECTOR, #1</p> |
| <p>STYLE 9:
 PIN 1. EMITTER, COMMON
 2. COLLECTOR, DIE #1
 3. COLLECTOR, DIE #2
 4. EMITTER, COMMON
 5. EMITTER, COMMON
 6. BASE, DIE #2
 7. BASE, DIE #1
 8. EMITTER, COMMON</p> | <p>STYLE 10:
 PIN 1. GROUND
 2. BIAS 1
 3. OUTPUT
 4. GROUND
 5. GROUND
 6. BIAS 2
 7. INPUT
 8. GROUND</p> | <p>STYLE 11:
 PIN 1. SOURCE 1
 2. GATE 1
 3. SOURCE 2
 4. GATE 2
 5. DRAIN 2
 6. DRAIN 2
 7. DRAIN 1
 8. DRAIN 1</p> | <p>STYLE 12:
 PIN 1. SOURCE
 2. SOURCE
 3. SOURCE
 4. GATE
 5. DRAIN
 6. DRAIN
 7. DRAIN
 8. DRAIN</p> |
| <p>STYLE 13:
 PIN 1. N.C.
 2. SOURCE
 3. SOURCE
 4. GATE
 5. DRAIN
 6. DRAIN
 7. DRAIN
 8. DRAIN</p> | <p>STYLE 14:
 PIN 1. N-SOURCE
 2. N-GATE
 3. P-SOURCE
 4. P-GATE
 5. P-DRAIN
 6. P-DRAIN
 7. N-DRAIN
 8. N-DRAIN</p> | <p>STYLE 15:
 PIN 1. ANODE 1
 2. ANODE 1
 3. ANODE 1
 4. ANODE 1
 5. CATHODE, COMMON
 6. CATHODE, COMMON
 7. CATHODE, COMMON
 8. CATHODE, COMMON</p> | <p>STYLE 16:
 PIN 1. EMITTER, DIE #1
 2. BASE, DIE #1
 3. EMITTER, DIE #2
 4. BASE, DIE #2
 5. COLLECTOR, DIE #2
 6. COLLECTOR, DIE #2
 7. COLLECTOR, DIE #1
 8. COLLECTOR, DIE #1</p> |
| <p>STYLE 17:
 PIN 1. VCC
 2. V2OUT
 3. V1OUT
 4. TXE
 5. RXE
 6. VEE
 7. GND
 8. ACC</p> | <p>STYLE 18:
 PIN 1. ANODE
 2. ANODE
 3. SOURCE
 4. GATE
 5. DRAIN
 6. DRAIN
 7. CATHODE
 8. CATHODE</p> | <p>STYLE 19:
 PIN 1. SOURCE 1
 2. GATE 1
 3. SOURCE 2
 4. GATE 2
 5. DRAIN 2
 6. MIRROR 2
 7. DRAIN 1
 8. MIRROR 1</p> | <p>STYLE 20:
 PIN 1. SOURCE (N)
 2. GATE (N)
 3. SOURCE (P)
 4. GATE (P)
 5. DRAIN
 6. DRAIN
 7. DRAIN
 8. DRAIN</p> |
| <p>STYLE 21:
 PIN 1. CATHODE 1
 2. CATHODE 2
 3. CATHODE 3
 4. CATHODE 4
 5. CATHODE 5
 6. COMMON ANODE
 7. COMMON ANODE
 8. CATHODE 6</p> | <p>STYLE 22:
 PIN 1. I/O LINE 1
 2. COMMON CATHODE/VCC
 3. COMMON CATHODE/VCC
 4. I/O LINE 3
 5. COMMON ANODE/GND
 6. I/O LINE 4
 7. I/O LINE 5
 8. COMMON ANODE/GND</p> | <p>STYLE 23:
 PIN 1. LINE 1 IN
 2. COMMON ANODE/GND
 3. COMMON ANODE/GND
 4. LINE 2 IN
 5. LINE 2 OUT
 6. COMMON ANODE/GND
 7. COMMON ANODE/GND
 8. LINE 1 OUT</p> | <p>STYLE 24:
 PIN 1. BASE
 2. EMITTER
 3. COLLECTOR/ANODE
 4. COLLECTOR/ANODE
 5. CATHODE
 6. CATHODE
 7. COLLECTOR/ANODE
 8. COLLECTOR/ANODE</p> |
| <p>STYLE 25:
 PIN 1. VIN
 2. N/C
 3. REXT
 4. GND
 5. IOUT
 6. IOUT
 7. IOUT
 8. IOUT</p> | <p>STYLE 26:
 PIN 1. GND
 2. dv/dt
 3. ENABLE
 4. ILIMIT
 5. SOURCE
 6. SOURCE
 7. SOURCE
 8. VCC</p> | <p>STYLE 27:
 PIN 1. ILIMIT
 2. OVLO
 3. UVLO
 4. INPUT+
 5. SOURCE
 6. SOURCE
 7. SOURCE
 8. DRAIN</p> | <p>STYLE 28:
 PIN 1. SW_TO_GND
 2. DASIC OFF
 3. DASIC_SW_DET
 4. GND
 5. V_MON
 6. VBULK
 7. VBULK
 8. VIN</p> |
| <p>STYLE 29:
 PIN 1. BASE, DIE #1
 2. EMITTER, #1
 3. BASE, #2
 4. EMITTER, #2
 5. COLLECTOR, #2
 6. COLLECTOR, #2
 7. COLLECTOR, #1
 8. COLLECTOR, #1</p> | <p>STYLE 30:
 PIN 1. DRAIN 1
 2. DRAIN 1
 3. GATE 2
 4. SOURCE 2
 5. SOURCE 1/DRAIN 2
 6. SOURCE 1/DRAIN 2
 7. SOURCE 1/DRAIN 2
 8. GATE 1</p> | | |

DOCUMENT NUMBER:	98ASB42564B	Electronic versions are uncontrolled except when accessed directly from the Document Repository. Printed versions are uncontrolled except when stamped "CONTROLLED COPY" in red.
DESCRIPTION:	SOIC-8 NB	PAGE 2 OF 2

ON Semiconductor and  are trademarks of Semiconductor Components Industries, LLC dba ON Semiconductor or its subsidiaries in the United States and/or other countries. ON Semiconductor reserves the right to make changes without further notice to any products herein. ON Semiconductor makes no warranty, representation or guarantee regarding the suitability of its products for any particular purpose, nor does ON Semiconductor assume any liability arising out of the application or use of any product or circuit, and specifically disclaims any and all liability, including without limitation special, consequential or incidental damages. ON Semiconductor does not convey any license under its patent rights nor the rights of others.