

## Precision micropower shunt voltage reference

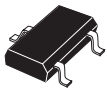

SOT23-3L

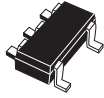

SOT323-5L

### Features

- Fixed 2.048 V, 2.5 V, 3.0 V, 4.096 V and 5.0 V output voltages
- Ultra low operating current: 10  $\mu$ A at 25 °C
- High precision @ 25 °C: +/- 0.1% (LM4040A), +/- 0.2% (LM4040B), +/- 0.5 % (LM4040C), +/- 1% (LM4040D)
- Very low LF noise: typ.10  $\mu$  Vp-p
- Stable when used with capacitive loads
- Industrial (-40 to +125 °C) temperature range
- 70 ppm/°C max. temperature coefficient
- Available in SOT23-3L and SOT323-5L packages

#### Maturity status link

[LM4040](#)

### Applications

- Portable, battery-operated equipment
- Data acquisition systems
- Instrumentation

### Description

The LM4040 is a low power and high accuracy shunt voltage reference providing a stable output voltage over the industrial temperature range (-40 to +125 °C), with a maximum temperature coefficient of 70 ppm/°C. It is available in 0.1%, 0.2%, 0.5% and 1% initial accuracy versions. The SOT323-5L and SOT23-3L packages can be designed in applications where space saving is a critical issue. The very low operating current is a key advantage for power restricted designs. The LM4040 is very stable and can be used in a broad range of application conditions.

# 1 Pin configuration

Figure 1. Pin configuration SOT23-3L, SOT323-5L (top view)

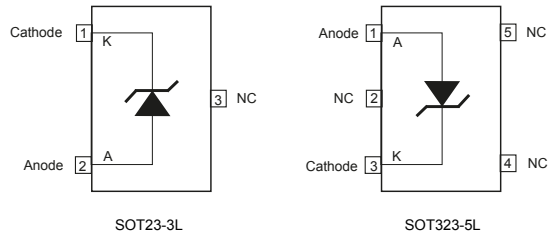

*Note:* The NC pin must be left unconnected or connected to anode.

## 2 Maximum ratings

**Table 1. Absolute maximum ratings**

Symbol	Parameter	Value	Unit
$I_k$	Reverse breakdown current	20	mA
$I_f$	Forward current	15	mA
$P_d$	Power dissipation <sup>(1)</sup>	500	mW
$T_{std}$	Storage temperature	-65 to +150	°C
ESD	Human Body Model (HBM)	2	kV
	Machine Model (MM)	200	V
	Charged device model	1500	V
$T_{lead}$	Lead temperature (soldering) 10 sec.	260	°C
$T_j$	Max. junction temperature	+150	°C

1.  $P_d$  has been calculated with  $T_{amb} = 25\text{ °C}$  and  $T_{jmax} = 150\text{ °C}$ .

*Note:* Absolute maximum ratings are those values beyond which damage to the device may occur. Functional operation under these conditions is not implied.

**Table 2. Thermal data**

Symbol	Parameter	SOT323-5L	SOT23-3L	Unit
$R_{thJA}$	Thermal resistance junction ambient	245	210	°C/W
$R_{thJC}$	Thermal resistance junction-case	105	103	°C/W

**Table 3. Operating conditions**

Symbol	Parameter	Value	Unit
$I_{kmin}$	Minimum operating current	10	μA
$I_{kmax}$	Maximum operating current	15	mA
$T_{oper}$	Operating free air temperature range	-40 to +125	°C

### 3 Electrical characteristics

Limits are 100% production tested at 25 °C. Limits over full temperature range are guaranteed through correlation and by design.  $I_k = 10 \mu\text{A}$ ,  $T_{\text{amb}} = 25 \text{ °C}$  (unless otherwise specified).

Symbol	Parameter	Test conditions	Min.	Typ.	Max.	Unit
$V_k$	Reverse breakdown voltage ( $V_k = 2.048 \text{ V}$ )	$I_k = 10 \mu\text{A}$ , LM4040A	2.0460	2.048	2.0500	V
		$I_k = 10 \mu\text{A}$ , LM4040B	2.0439		2.0521	
		$I_k = 10 \mu\text{A}$ , LM4040C	2.0378		2.0582	
		$I_k = 10 \mu\text{A}$ , LM4040D	2.0275		2.0685	
	Reverse breakdown voltage ( $V_k = 2.5 \text{ V}$ )	$I_k = 10 \mu\text{A}$ , LM4040A	2.4975	2.50	2.5025	V
		$I_k = 10 \mu\text{A}$ , LM4040B	2.4950		2.5050	
		$I_k = 10 \mu\text{A}$ , LM4040C	2.04875		2.5125	
		$I_k = 10 \mu\text{A}$ , LM4040D	2.4750		2.5250	
	Reverse breakdown voltage ( $V_k = 3.0 \text{ V}$ )	$I_k = 12 \mu\text{A}$ , LM4040A	2.9970	3.0	3.0030	V
		$I_k = 12 \mu\text{A}$ , LM4040B	2.9940		3.0060	
		$I_k = 12 \mu\text{A}$ , LM4040c	2.9850		3.0150	
		$I_k = 12 \mu\text{A}$ , LM4040D	2.9700		3.0300	
	Reverse breakdown voltage ( $V_k = 4.096 \text{ V}$ )	$I_k = 20 \mu\text{A}$ , LM4040A	4.0919	4.096	4.1001	V
		$I_k = 20 \mu\text{A}$ , LM4040B	4.0878		4.1042	
		$I_k = 20 \mu\text{A}$ , LM4040C	4.0755		4.1165	
		$I_k = 20 \mu\text{A}$ , LM4040D	4.0550		4.1370	
Reverse breakdown voltage ( $V_k = 4.096 \text{ V}$ )	$I_k = 20 \mu\text{A}$ , LM4040A	4.9950	5.0	5.0050	V	
	$I_k = 20 \mu\text{A}$ , LM4040B	4.9900		5.0100		
	$I_k = 20 \mu\text{A}$ , LM4040C	4.9750		5.0250		
	$I_k = 20 \mu\text{A}$ , LM4040D	4.9500		5.0500		
$I_{k\text{min}}$	Minimum operating current	$T_{\text{amb}} = 25 \text{ °C}$ , $V_k < 2.5 \text{ V}$		7.5	10	mA
		$-40 \text{ °C} < T_{\text{amb}} < +125 \text{ °C}$			12	
		$T_{\text{amb}} = 25 \text{ °C}$ , $V_k > 3.0 \text{ V}$		15	20	
		$-40 \text{ °C} < T_{\text{amb}} < +125 \text{ °C}$			25	
$\Delta V_k / \Delta T$	Average temperature coefficient	$10 \mu\text{A} < I_k < 20 \text{ mA}$		20	70	ppm/°C
$\Delta V_k / \Delta I_k$	Reverse breakdown voltage change with operating current range	$I_k \text{ min} < I_k < 1 \text{ mA}$ $-40 \text{ °C} < T_{\text{amb}} < +125 \text{ °C}$		0.2	1	mV
		$1 \text{ mA} < I_k < 15 \text{ mA}$ $-40 \text{ °C} < T_{\text{amb}} < +125 \text{ °C}$		1.7	4	
$R_{ka}$	Static impedance	$\Delta I_k = 10 \mu\text{A}$ to $10 \text{ mA}$		0.15	0.3	$\Omega$
Hys	Thermal hysteresis <sup>(1)</sup>	$I_k = 10 \mu\text{A}$		120		ppm
Noise	Wideband noise	$I_k = 10 \mu\text{A}$ , $10 \text{ Hz} < f < 10 \text{ kHz}$		95		mV <sub>RMS</sub>
	Low frequency noise	$I_k = 10 \mu\text{A}$ , $0.1 \text{ Hz} < f < 10 \text{ Hz}$		10		$\mu\text{Vp-p}$

1. Thermal hysteresis is defined as the difference in voltage measured at +25 °C after cycling to -40 °C and the measurement at +25 °C after cycling to temperature +125 °C.

## 4 Typical performance characteristics

( $C_{IN} = 1 \mu\text{F}$ ;  $C_{OUT} = 10 \mu\text{F}$ ,  $T_J = 25^\circ\text{C}$  unless otherwise specified.)

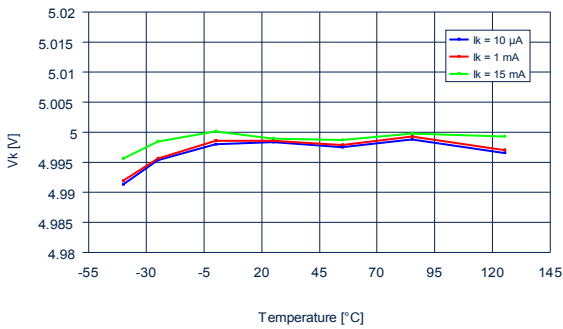
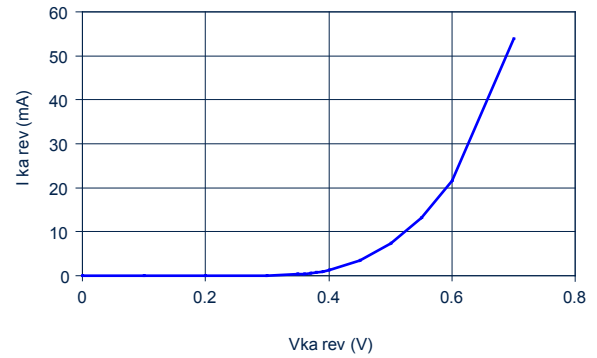
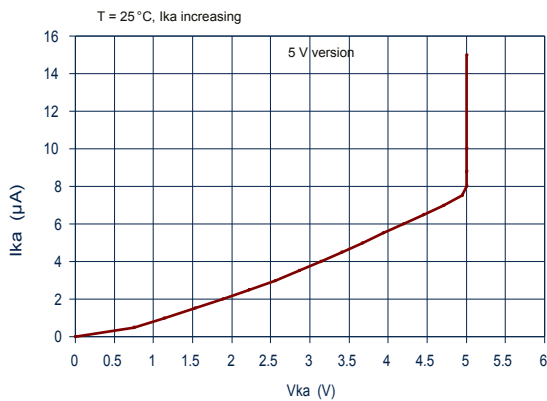
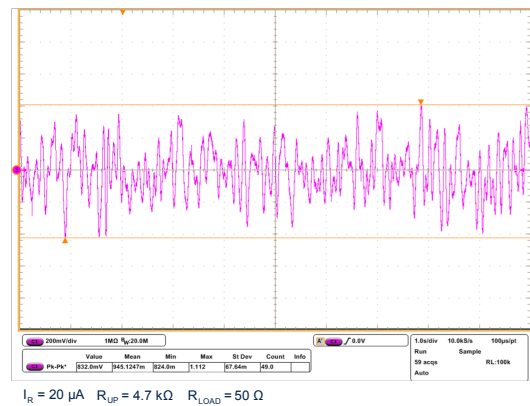
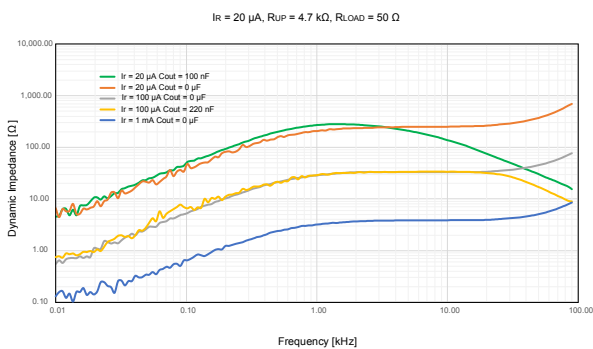
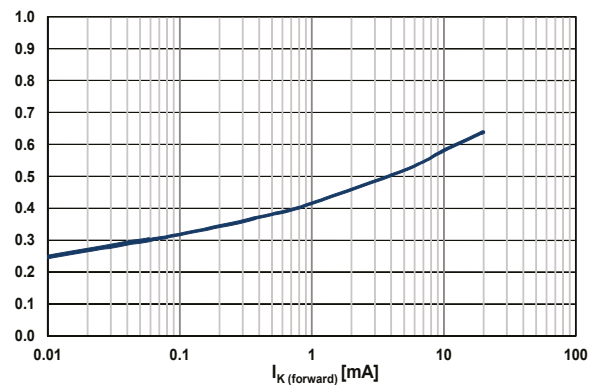
**Figure 2.  $V_K$  change vs. temperature (5 V version)**

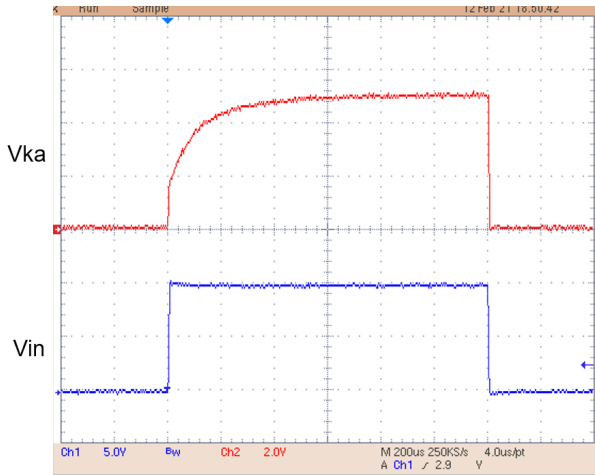
**Figure 3.  $V_K$  change vs. temperature (5 V version)**

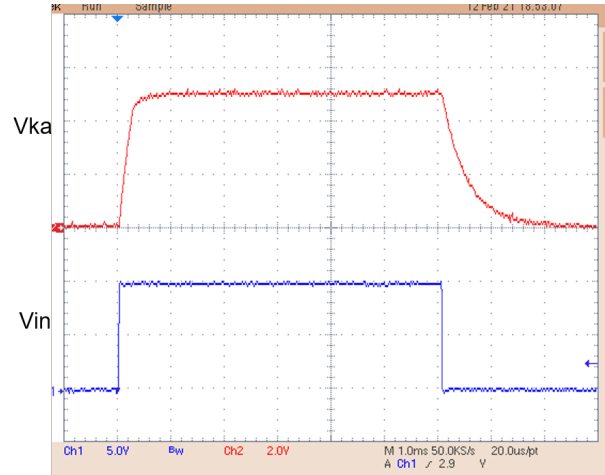
**Figure 4.  $I_{Kmin}$  minimum current for regulation**

**Figure 5. Low frequency noise test**

**Figure 6. Measured dynamic impedance**

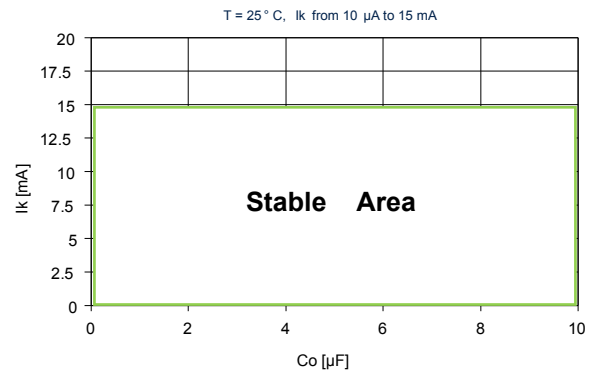
**Figure 7. Forward characteristics**

**Figure 8. Turn-on time setting (no Load)**

 Vin: 10 V, trise: 5  $\mu$ sec, Ika: 10  $\mu$ A, No Load

**Figure 9. Turn-on time setting (Load = 100 nF)**

 Vin: 10 V, trise: 5  $\mu$ sec, Ika: 10  $\mu$ A, Load: 100 nF

**Figure 10. Turn-on time setting (Load = 1  $\mu$ F)**

 Vin: 10 V, trise: 5  $\mu$ sec, Ika: 10  $\mu$ A, Load: 1  $\mu$ F

**Figure 11. Stability plane vs. Cout**

## 5 Package information

In order to meet environmental requirements, ST offers these devices in different grades of **ECOPACK** packages, depending on their level of environmental compliance. ECOPACK specifications, grade definitions and product status are available at: [www.st.com](http://www.st.com). ECOPACK is an ST trademark.

### 5.1 SOT23-3L package information

Figure 12. SOT23-3L package outline

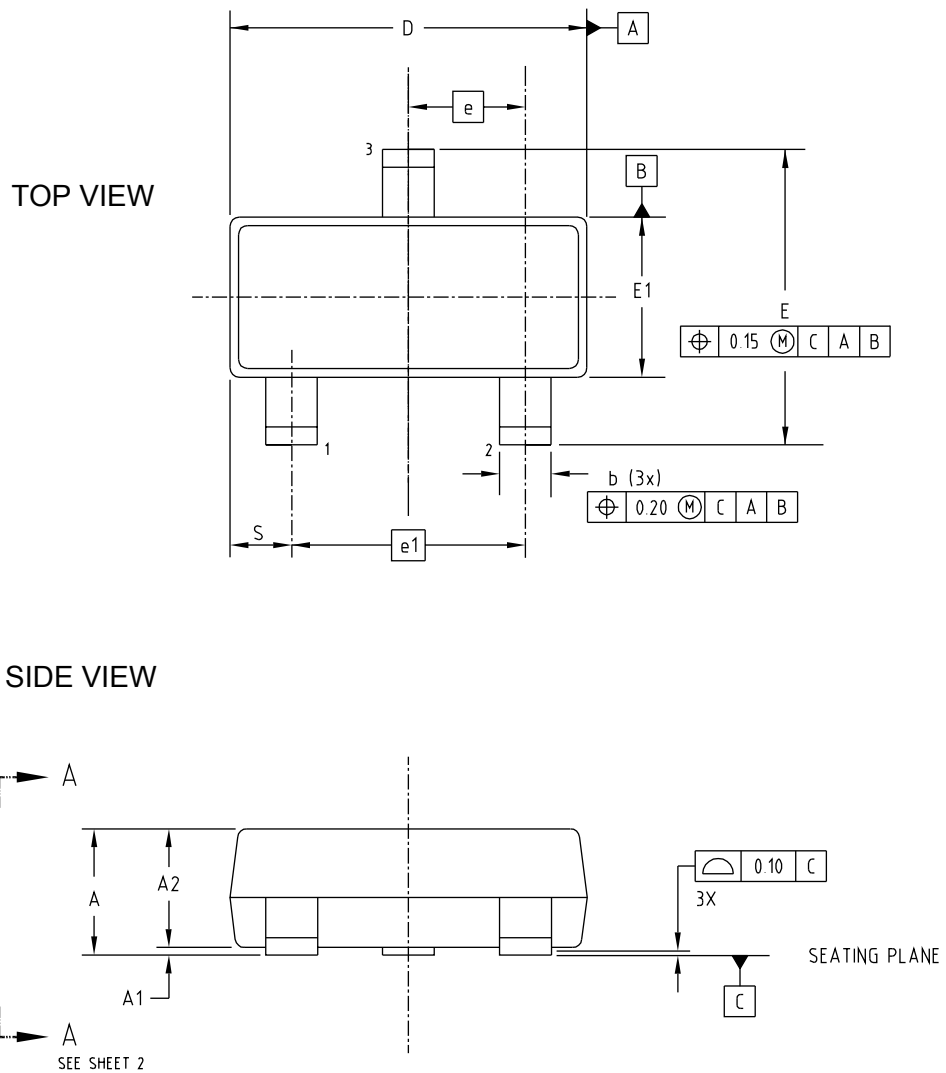
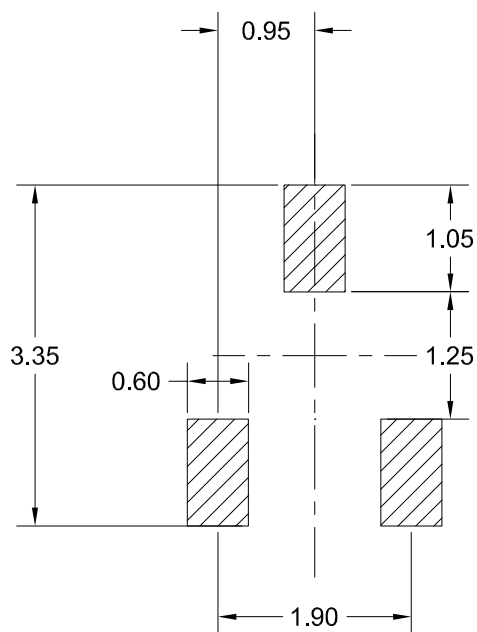

Table 4. SOT23-3L mechanical data

Dim.	mm		
	Min.	Typ.	Max.
A	0.80		1.10
A1	0		0.10
A2	0.80	0.90	1
b	0.15		0.30
c	0.10		0.22
D	1.80	2	2.20
E	1.80	2.10	2.40
E1	1.15	1.25	1.35
e		0.65	
e1		130	
L	0.26	0.36	0.46
<	0°		8°

Figure 13. SOT23-3L recommended footprint



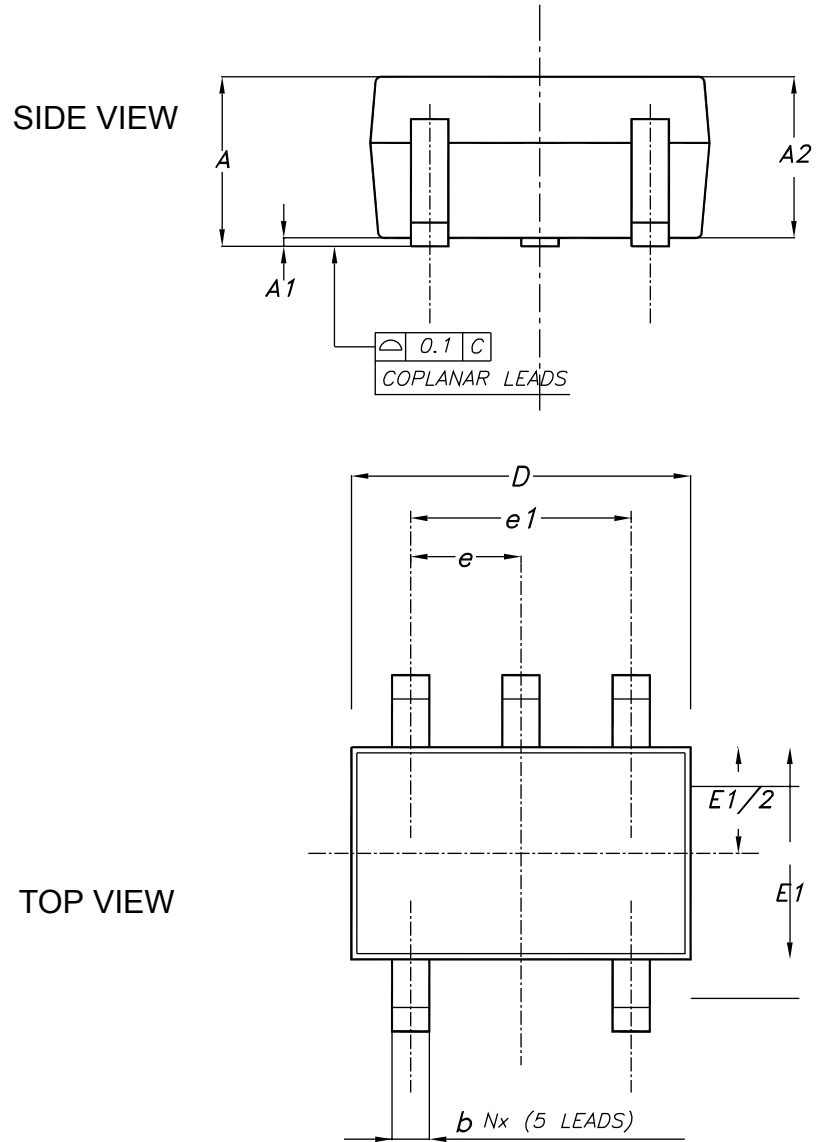

**5.2 SOT323-5L package information**
**Figure 14. SOT323-5L package outline**

**Table 5. SOT323-5L mechanical data**

Dim.	mm		
	Min.	Typ.	Max.
A	0.89		1.12
A1	0.013		0.10
A2	0.88	0.95	1.2
b	0.37		0.50
b1	0.37	0.40	0.45
c	0.085		0.18
c1	0.085		0.16
D	2.80	2.90	3.04
E	2.10		2.64
E1	1.20	1.30	1.40
e		0.95 BSC	
e1		1.90 BSC	
L	0.28	0.38	0.48
L1	0.55 REF		
L2			
R	0.05		
R1	0.05		
θ	0°		8°
s	0.45		0.60

**Figure 15. SOT323-5L recommended footprint**

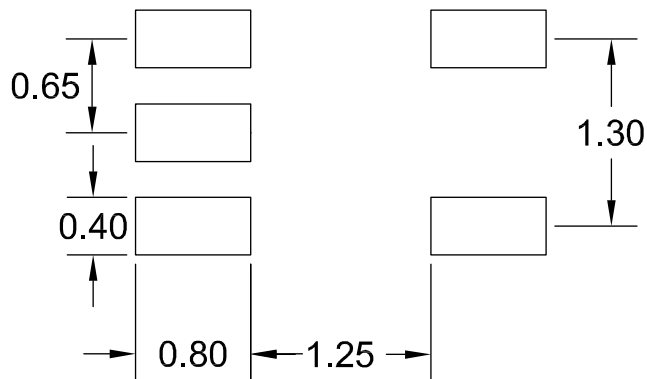

### 5.3 SOT23-3L packing information

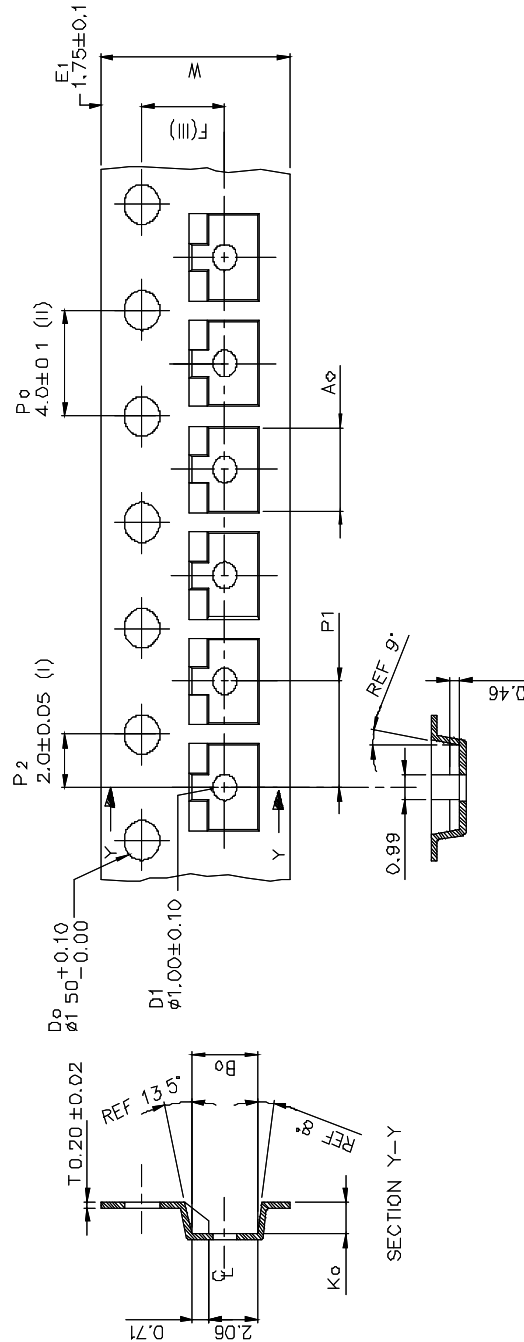
**Figure 16. SOT23-3L tape outline**

- (I) Measured from centreline of sprocket hole to centreline of pocket.
- (II) Cumulative tolerance of 10 sprocket holes is  $\pm 0.20$ .
- (III) Measured from centreline of sprocket hole to centreline of pocket.
- (IV) Other material available.
- (V) Typical SR of form tape Max. 10° OHM/SR

ALL DIMENSIONS IN MILLIMETRES UNLESS OTHERWISE STATED.

$A_0$	$3.15$	$+/-0.10$
$B_0$	$2.77$	$+/-0.10$
$K_0$	$1.22$	$+/-0.10$
$F$	$3.50$	$+/-0.05$
$P_1$	$4.00$	$+/-0.10$
$W$	$8.00$	$+0.3/-0.1$

**Figure 17. SOT23-3L reel drawing**

Figure 18. SOT23-3L tape direction



## 5.4 SOT323-5L packing information

Figure 19. SOT323-5L tape outline

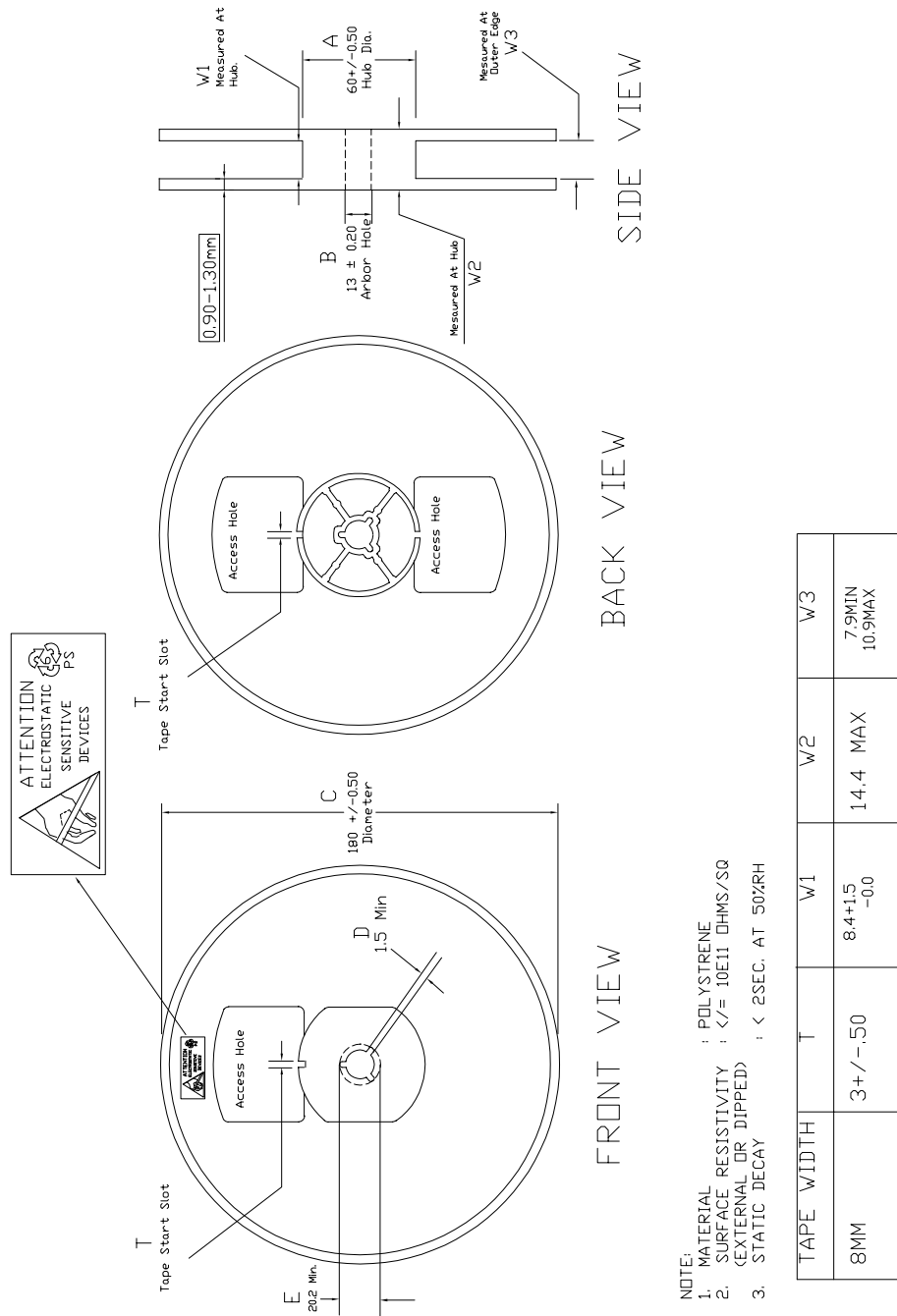
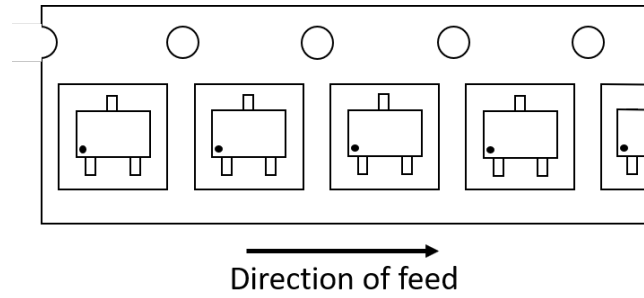
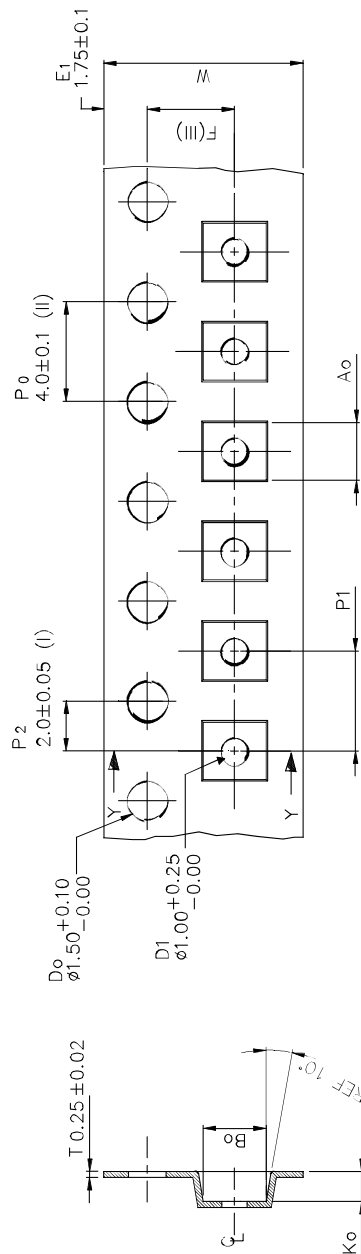

- (I) Measured from centreline of sprocket hole to centreline of pocket.
  - (II) Cumulative tolerance of 10 sprocket holes is  $\pm 0.20$ .
  - (III) Measured from centreline of sprocket hole to centreline of pocket.
  - (IV) Other material available.
  - (V) Typical SR of form tape to be  $10^4 \leq SR < 10^{11}$  OHMS.
- ALL DIMENSIONS IN MILLIMETRES UNLESS OTHERWISE STATED.

Ao	2.25 + / - 0.10
Bo	2.45 + / - 0.10
Ko	1.20 + / - 0.10
F	3.50 + / - 0.05
P1	4.00 + / - 0.10
W	8.00 + 0.3 / - 0.1

Figure 20. SOT323-5L reel drawing

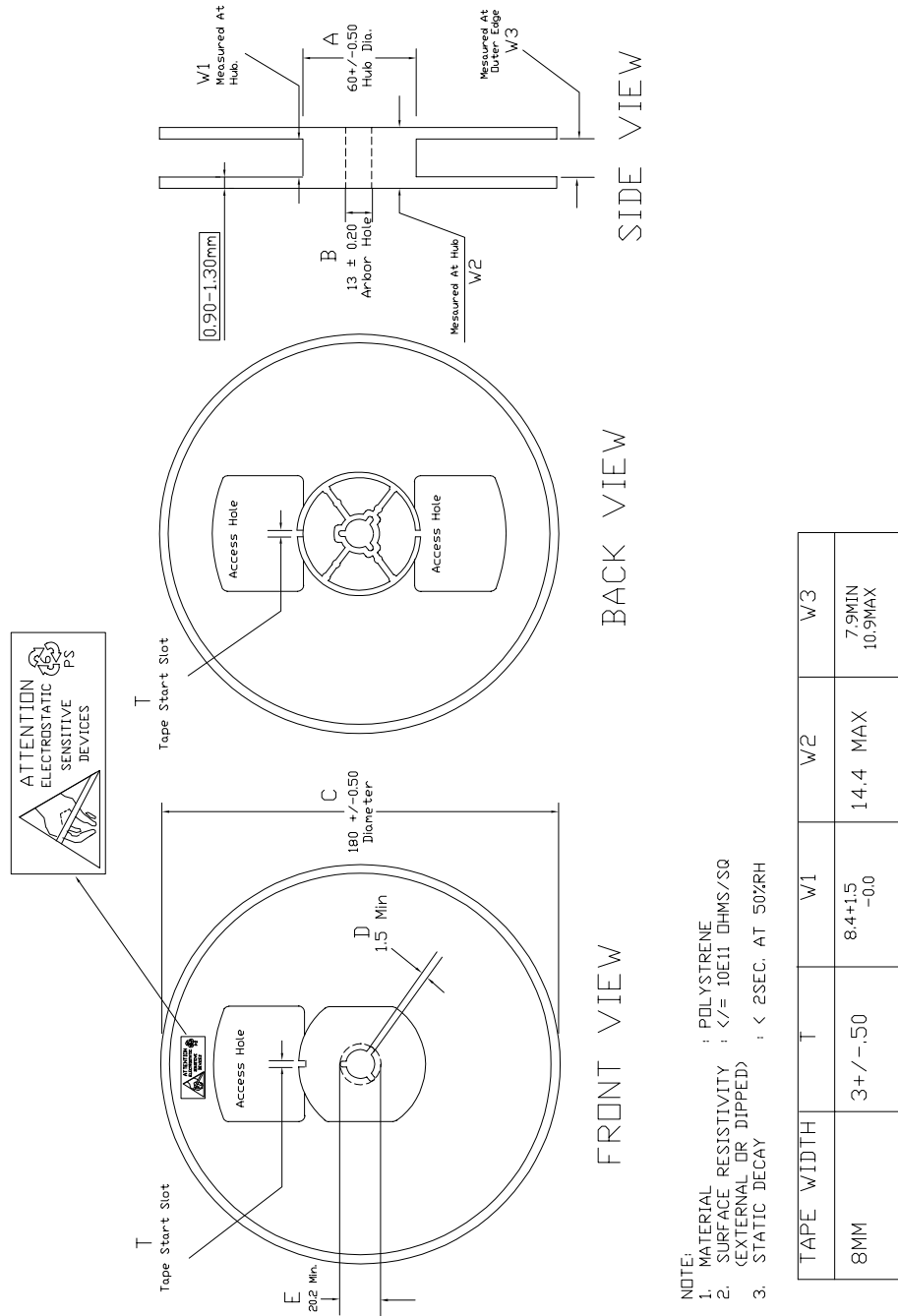
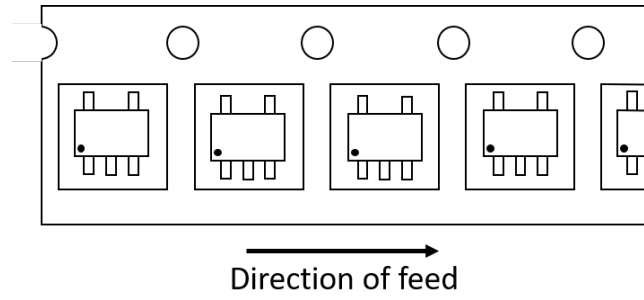

Figure 21. SOT323-5L tape direction



## 6 Ordering information

Order codes	Precision (%)	Package	Output voltage (V)	Marking	Temperature range (°C)
LM4040AELT-2.0	0.1%	SOT23-3L	2.048	A20	-40°C to +125°C
LM4040BELT-2.0	0.2%	SOT23-3L	2.048	B20	-40°C to +125°C
LM4040CELT-2.0	0.5%	SOT23-3L	2.048	C20	-40°C to +125°C
LM4040DELT-2.0	1.0%	SOT23-3L	2.048	D20	-40°C to +125°C
LM4040AECT-2.0	0.1%	SOT323-5L	2.048	A20	-40°C to +125°C
LM4040BECT-2.0	0.2%	SOT323-5L	2.048	A20	-40°C to +125°C
LM4040CECT-2.0	0.5%	SOT323-5L	2.048	C20	-40°C to +125°C
LM4040DECT-2.0	1.0%	SOT323-5L	2.048	D20	-40°C to +125°C
LM4040AELT-2.5	0.1%	SOT23-3L	2.5	A25	-40°C to +125°C
LM4040BELT-2.5	0.2%	SOT23-3L	2.5	B25	-40°C to +125°C
LM4040CELT-2.5	0.5%	SOT23-3L	2.5	C25	-40°C to +125°C
LM4040DELT-2.5	1.0%	SOT23-3L	2.5	D25	-40°C to +125°C
LM4040AECT-2.5	0.1%	SOT323-5L	2.5	A25	-40°C to +125°C
LM4040BECT-2.5	0.2%	SOT323-5L	2.5	A25	-40°C to +125°C
LM4040CECT-2.5	0.5%	SOT323-5L	2.5	C25	-40°C to +125°C
LM4040DECT-2.5	1.0%	SOT323-5L	2.5	D25	-40°C to +125°C
LM4040AELT-3.0	0.1%	SOT23-3L	3.0	A30	-40°C to +125°C
LM4040BELT-3.0	0.2%	SOT23-3L	3.0	B30	-40°C to +125°C
LM4040CELT-3.0	0.5%	SOT23-3L	3.0	C30	-40°C to +125°C
LM4040DELT-3.0	1.0%	SOT23-3L	3.0	D30	-40°C to +125°C
LM4040AECT-3.0	0.1%	SOT323-5L	3.0	A30	-40°C to +125°C
LM4040BECT-3.0	0.2%	SOT323-5L	3.0	A30	-40°C to +125°C
LM4040CECT-3.0	0.5%	SOT323-5L	3.0	C30	-40°C to +125°C
LM4040DECT-3.0	1.0%	SOT323-5L	3.0	D30	-40°C to +125°C
LM4040AELT-4.1	0.1%	SOT23-3L	4.096	A40	-40°C to +125°C
LM4040BELT-4.1	0.2%	SOT23-3L	4.096	B40	-40°C to +125°C
LM4040CELT-4.1	0.5%	SOT23-3L	4.096	C40	-40°C to +125°C
LM4040DELT-4.1	1.0%	SOT23-3L	4.096	D40	-40°C to +125°C
LM4040AECT-4.1	0.1%	SOT323-5L	4.096	A40	-40°C to +125°C
LM4040BECT-4.1	0.2%	SOT323-5L	4.096	A40	-40°C to +125°C
LM4040CECT-4.1	0.5%	SOT323-5L	4.096	C40	-40°C to +125°C
LM4040DECT-4.1	1.0%	SOT323-5L	4.096	D40	-40°C to +125°C
LM4040AELT-5.0	0.1%	SOT23-3L	5.0	A50	-40°C to +125°C
LM4040BELT-5.0	0.2%	SOT23-3L	5.0	B50	-40°C to +125°C
LM4040CELT-5.0	0.5%	SOT23-3L	5.0	C50	-40°C to +125°C
LM4040DELT-5.0	1.0%	SOT23-3L	5.0	D50	-40°C to +125°C
LM4040AECT-5.0	0.1%	SOT323-5L	5.0	A50	-40°C to +125°C
LM4040BECT-5.0	0.2%	SOT323-5L	5.0	A50	-40°C to +125°C



Order codes	Precision (%)	Package	Output voltage (V)	Marking	Temperature range (°C)
LM4040CECT-5.0	0.5%	SOT323-5L	5.0	C50	-40°C to +125°C
LM4040DECT-5.0	1.0%	SOT323-5L	5.0	D50	-40°C to +125°C

---

## Revision history

**Table 6. Document revision history**

Date	Version	Changes
26-Jan-2021	1	First release.

---

## Contents

<b>1</b>	<b>Pin configuration</b> .....	<b>2</b>
<b>2</b>	<b>Maximum ratings</b> .....	<b>3</b>
<b>3</b>	<b>Electrical characteristics</b> .....	<b>4</b>
<b>4</b>	<b>Typical performance characteristics</b> .....	<b>5</b>
<b>5</b>	<b>Package information</b> .....	<b>7</b>
<b>5.1</b>	SOT23-3L package information .....	7
<b>5.2</b>	SOT323-5L package information .....	9
<b>5.3</b>	SOT23-3L packing information .....	11
<b>5.4</b>	SOT323-5L packing information .....	13
<b>6</b>	<b>Ordering information</b> .....	<b>16</b>
	<b>Revision history</b> .....	<b>18</b>

## List of tables

<b>Table 1.</b>	Absolute maximum ratings . . . . .	3
<b>Table 2.</b>	Thermal data . . . . .	3
<b>Table 3.</b>	Operating conditions . . . . .	3
<b>Table 4.</b>	SOT23-3L mechanical data . . . . .	8
<b>Table 5.</b>	SOT323-5L mechanical data . . . . .	10
<b>Table 6.</b>	Document revision history . . . . .	18

## List of figures

<b>Figure 1.</b>	Pin configuration SOT23-3L, SOT323-5L (top view) . . . . .	2
<b>Figure 2.</b>	$V_K$ change vs. temperature (5 V version) . . . . .	5
<b>Figure 3.</b>	$V_K$ change vs. temperature (5 V version) . . . . .	5
<b>Figure 4.</b>	$I_{Kmin}$ minimum current for regulation . . . . .	5
<b>Figure 5.</b>	Low frequency noise test . . . . .	5
<b>Figure 6.</b>	Measured dynamic impedance . . . . .	5
<b>Figure 7.</b>	Forward characteristics . . . . .	5
<b>Figure 8.</b>	Turn-on time setting (no Cload ) . . . . .	6
<b>Figure 9.</b>	Turn-on time setting (Cload = 100 nF) . . . . .	6
<b>Figure 10.</b>	Turn-on time setting (Cload = 1 $\mu$ F) . . . . .	6
<b>Figure 11.</b>	Stability plane vs. Cout . . . . .	6
<b>Figure 12.</b>	SOT23-3L package outline . . . . .	7
<b>Figure 13.</b>	SOT23-3L recommended footprint . . . . .	8
<b>Figure 14.</b>	SOT323-5L package outline . . . . .	9
<b>Figure 15.</b>	SOT323-5L recommended footprint . . . . .	10
<b>Figure 16.</b>	SOT23-3L tape outline . . . . .	11
<b>Figure 17.</b>	SOT23-3L reel drawing . . . . .	12
<b>Figure 18.</b>	SOT23-3L tape direction . . . . .	13
<b>Figure 19.</b>	SOT323-5L tape outline . . . . .	13
<b>Figure 20.</b>	SOT323-5L reel drawing . . . . .	14
<b>Figure 21.</b>	SOT323-5L tape direction . . . . .	15