

Precision micropower shunt voltage reference

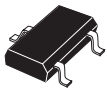

SOT23-3L

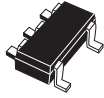

SOT323-5L

Features

- Fixed 2.048 V, 2.5 V, 3.0 V, 4.096 V and 5.0 V output voltages
- Ultra low operating current: 10 μ A at 25 °C
- High precision @ 25 °C: +/- 0.1% (LM4040A), +/- 0.2% (LM4040B), +/- 0.5 % (LM4040C), +/- 1% (LM4040D)
- Very low LF noise: typ.10 μ Vp-p
- Stable when used with capacitive loads
- Industrial (-40 to +125 °C) temperature range
- 70 ppm/°C max. temperature coefficient
- Available in SOT23-3L and SOT323-5L packages

Maturity status link

[LM4040](#)

Applications

- Portable, battery-operated equipment
- Data acquisition systems
- Instrumentation

Description

The LM4040 is a low power and high accuracy shunt voltage reference providing a stable output voltage over the industrial temperature range (-40 to +125 °C), with a maximum temperature coefficient of 70 ppm/°C. It is available in 0.1%, 0.2%, 0.5% and 1% initial accuracy versions. The SOT323-5L and SOT23-3L packages can be designed in applications where space saving is a critical issue. The very low operating current is a key advantage for power restricted designs. The LM4040 is very stable and can be used in a broad range of application conditions.

1 Pin configuration

Figure 1. Pin configuration SOT23-3L, SOT323-5L (top view)

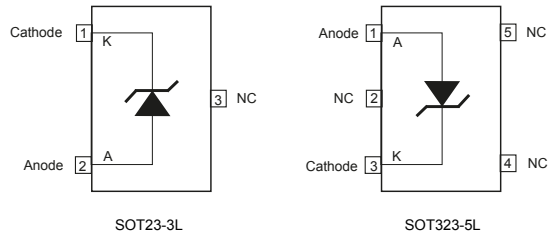

Note: The NC pin must be left unconnected or connected to anode.

2 Maximum ratings

Table 1. Absolute maximum ratings

Symbol	Parameter	Value	Unit
I_k	Reverse breakdown current	20	mA
I_f	Forward current	15	mA
P_d	Power dissipation ⁽¹⁾	500	mW
T_{std}	Storage temperature	-65 to +150	°C
ESD	Human Body Model (HBM)	2	kV
	Machine Model (MM)	200	V
	Charged device model	1500	V
T_{lead}	Lead temperature (soldering) 10 sec.	260	°C
T_j	Max. junction temperature	+150	°C

1. P_d has been calculated with $T_{amb} = 25\text{ °C}$ and $T_{jmax} = 150\text{ °C}$.

Note: *Absolute maximum ratings are those values beyond which damage to the device may occur. Functional operation under these conditions is not implied.*

Table 2. Thermal data

Symbol	Parameter	SOT323-5L	SOT23-3L	Unit
R_{thJA}	Thermal resistance junction ambient	245	210	°C/W
R_{thJC}	Thermal resistance junction-case	105	103	°C/W

Table 3. Operating conditions

Symbol	Parameter	Value	Unit
I_{kmin}	Minimum operating current	10	μA
I_{kmax}	Maximum operating current	15	mA
T_{oper}	Operating free air temperature range	-40 to +125	°C

3 Electrical characteristics

Limits are 100% production tested at 25 °C. Limits over full temperature range are guaranteed through correlation and by design. $I_k = 10 \mu\text{A}$, $T_{\text{amb}} = 25 \text{ °C}$ (unless otherwise specified).

Symbol	Parameter	Test conditions	Min.	Typ.	Max.	Unit
V_k	Reverse breakdown voltage ($V_k = 2.048 \text{ V}$)	$I_k = 10 \mu\text{A}$, LM4040A	2.0460	2.048	2.0500	V
		$I_k = 10 \mu\text{A}$, LM4040B	2.0439		2.0521	
		$I_k = 10 \mu\text{A}$, LM4040C	2.0378		2.0582	
		$I_k = 10 \mu\text{A}$, LM4040D	2.0275		2.0685	
	Reverse breakdown voltage ($V_k = 2.5 \text{ V}$)	$I_k = 10 \mu\text{A}$, LM4040A	2.4975	2.50	2.5025	V
		$I_k = 10 \mu\text{A}$, LM4040B	2.4950		2.5050	
		$I_k = 10 \mu\text{A}$, LM4040C	2.04875		2.5125	
		$I_k = 10 \mu\text{A}$, LM4040D	2.4750		2.5250	
	Reverse breakdown voltage ($V_k = 3.0 \text{ V}$)	$I_k = 12 \mu\text{A}$, LM4040A	2.9970	3.0	3.0030	V
		$I_k = 12 \mu\text{A}$, LM4040B	2.9940		3.0060	
		$I_k = 12 \mu\text{A}$, LM4040c	2.9850		3.0150	
		$I_k = 12 \mu\text{A}$, LM4040D	2.9700		3.0300	
	Reverse breakdown voltage ($V_k = 4.096 \text{ V}$)	$I_k = 20 \mu\text{A}$, LM4040A	4.0919	4.096	4.1001	V
		$I_k = 20 \mu\text{A}$, LM4040B	4.0878		4.1042	
		$I_k = 20 \mu\text{A}$, LM4040C	4.0755		4.1165	
		$I_k = 20 \mu\text{A}$, LM4040D	4.0550		4.1370	
Reverse breakdown voltage ($V_k = 4.096 \text{ V}$)	$I_k = 20 \mu\text{A}$, LM4040A	4.9950	5.0	5.0050	V	
	$I_k = 20 \mu\text{A}$, LM4040B	4.9900		5.0100		
	$I_k = 20 \mu\text{A}$, LM4040C	4.9750		5.0250		
	$I_k = 20 \mu\text{A}$, LM4040D	4.9500		5.0500		
$I_{k\text{min}}$	Minimum operating current	$T_{\text{amb}} = 25 \text{ °C}$, $V_k < 2.5 \text{ V}$		7.5	10	mA
		$-40 \text{ °C} < T_{\text{amb}} < +125 \text{ °C}$			12	
		$T_{\text{amb}} = 25 \text{ °C}$, $V_k > 3.0 \text{ V}$		15	20	
		$-40 \text{ °C} < T_{\text{amb}} < +125 \text{ °C}$			25	
$\Delta V_k / \Delta T$	Average temperature coefficient	$10 \mu\text{A} < I_k < 20 \text{ mA}$		20	70	ppm/°C
$\Delta V_k / \Delta I_k$	Reverse breakdown voltage change with operating current range	$I_k \text{ min} < I_k < 1 \text{ mA}$ $-40 \text{ °C} < T_{\text{amb}} < +125 \text{ °C}$		0.2	1	mV
		$1 \text{ mA} < I_k < 15 \text{ mA}$ $-40 \text{ °C} < T_{\text{amb}} < +125 \text{ °C}$		1.7	4	
R_{ka}	Static impedance	$\Delta I_k = 10 \mu\text{A}$ to 10 mA		0.15	0.3	Ω
Hys	Thermal hysteresis ⁽¹⁾	$I_k = 10 \mu\text{A}$		120		ppm
Noise	Wideband noise	$I_k = 10 \mu\text{A}$, $10 \text{ Hz} < f < 10 \text{ kHz}$		95		mV _{RMS}
	Low frequency noise	$I_k = 10 \mu\text{A}$, $0.1 \text{ Hz} < f < 10 \text{ Hz}$		10		$\mu\text{Vp-p}$

1. Thermal hysteresis is defined as the difference in voltage measured at +25 °C after cycling to -40 °C and the measurement at +25 °C after cycling to temperature +125 °C.

4 Typical performance characteristics

($C_{IN} = 1 \mu\text{F}$; $C_{OUT} = 10 \mu\text{F}$, $T_J = 25^\circ\text{C}$ unless otherwise specified.)

Figure 2. V_K change vs. temperature (5 V version)

Figure 3. V_K change vs. temperature (5 V version)

Figure 4. I_{Kmin} minimum current for regulation

Figure 5. Low frequency noise test

Figure 6. Measured dynamic impedance

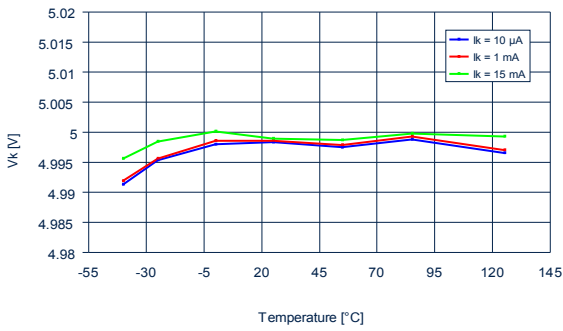
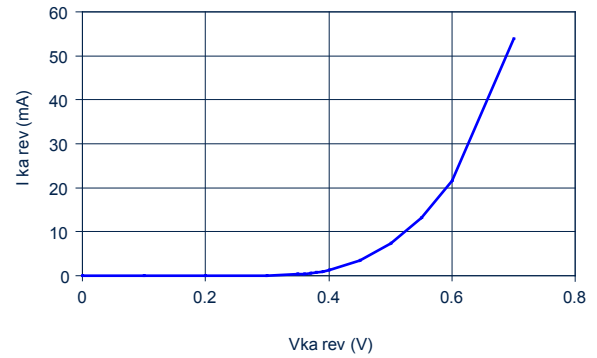
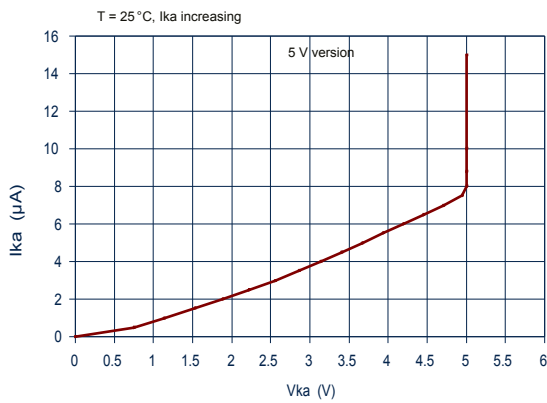
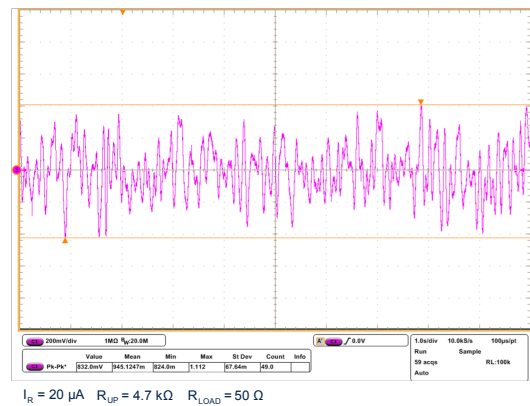
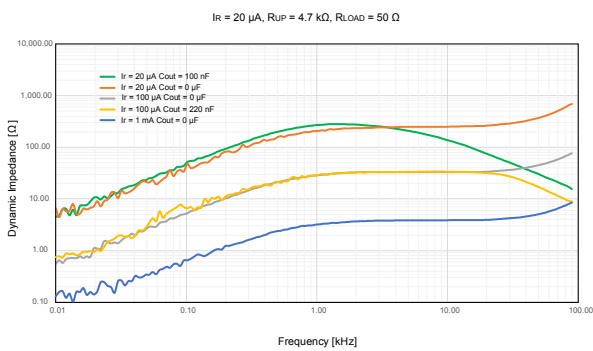
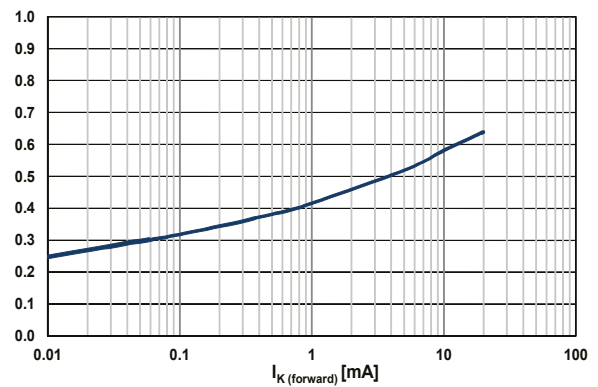
Figure 7. Forward characteristics

Figure 8. Turn-on time setting (no Load)

 Vin: 10 V, trise: 5 μ sec, Ika: 10 μ A, No Load

Figure 9. Turn-on time setting (Load = 100 nF)

 Vin: 10 V, trise: 5 μ sec, Ika: 10 μ A, Load: 100 nF

Figure 10. Turn-on time setting (Load = 1 μ F)

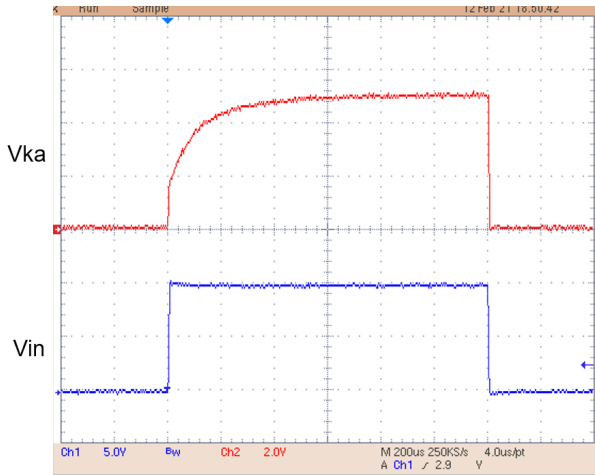
 Vin: 10 V, trise: 5 μ sec, Ika: 10 μ A, Load: 1 μ F

Figure 11. Stability plane vs. Cout

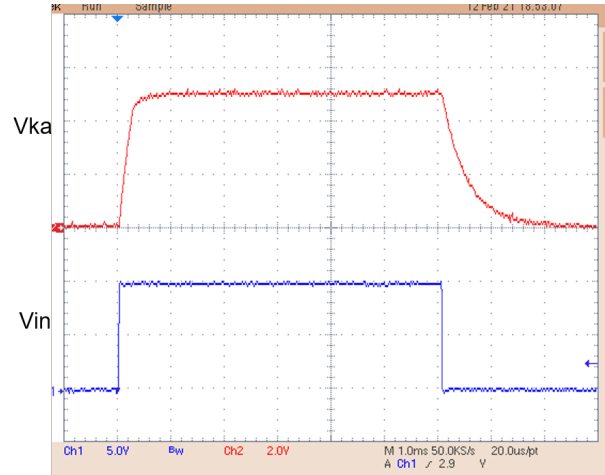
5 Package information

In order to meet environmental requirements, ST offers these devices in different grades of **ECOPACK** packages, depending on their level of environmental compliance. ECOPACK specifications, grade definitions and product status are available at: www.st.com. ECOPACK is an ST trademark.

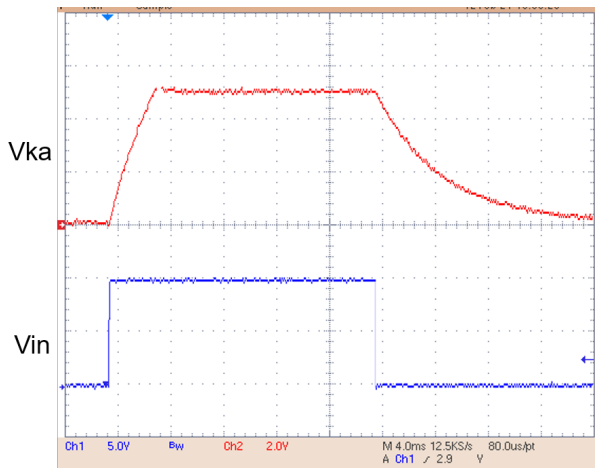
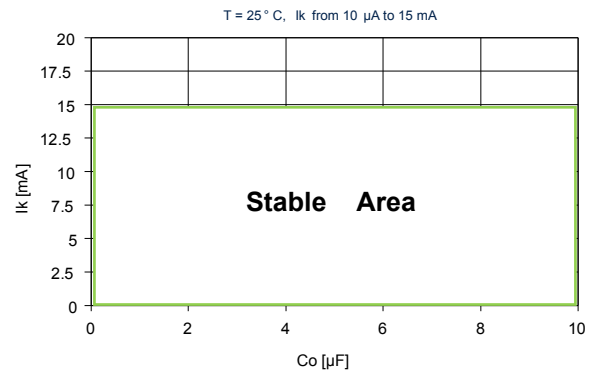
5.1 SOT23-3L package information

Figure 12. SOT23-3L package outline

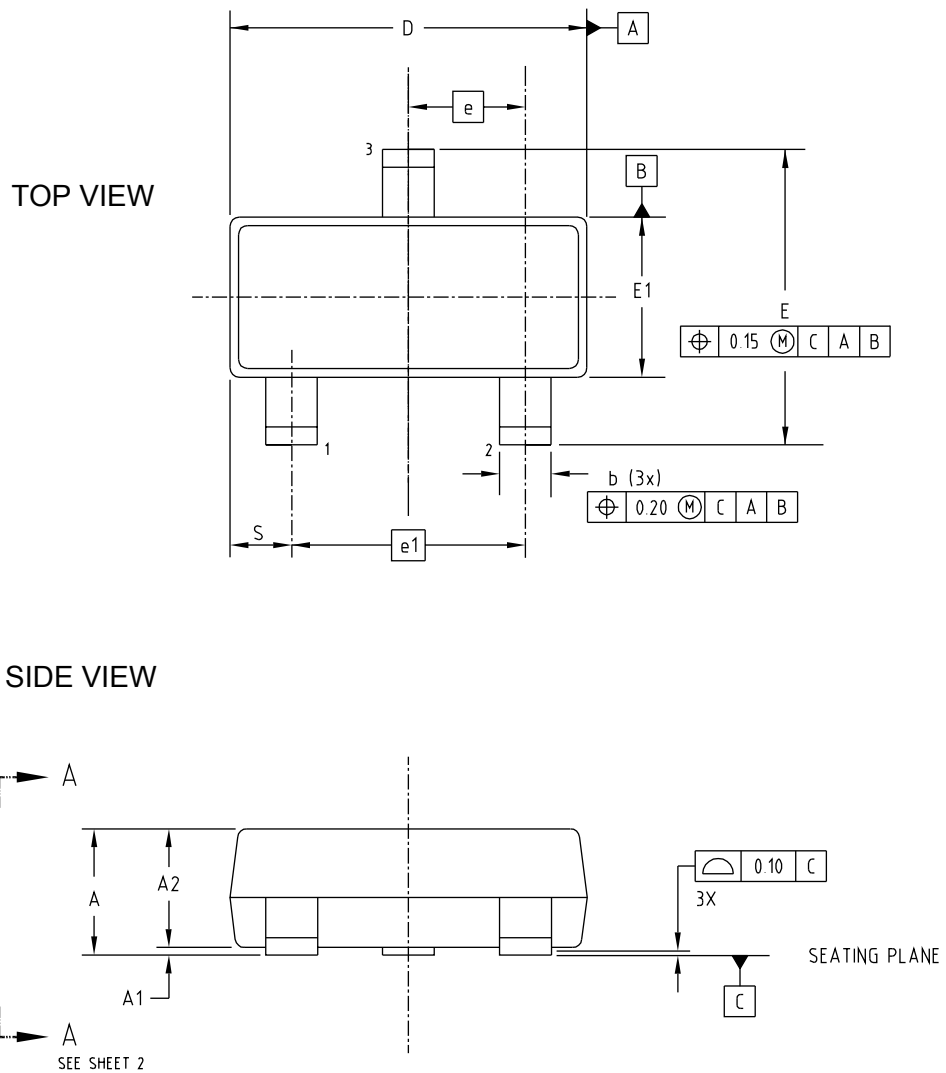
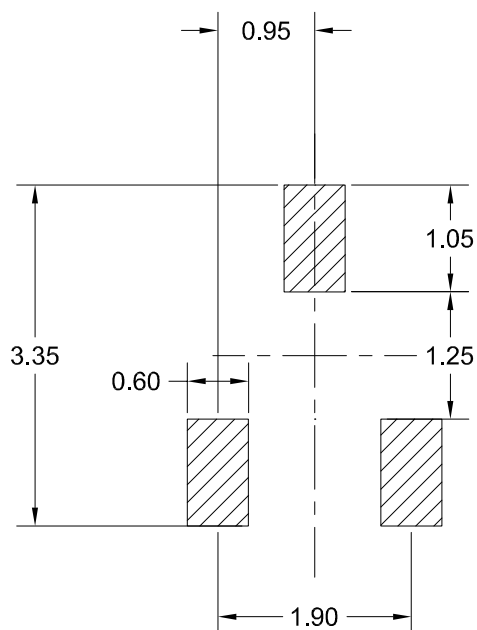

Table 4. SOT23-3L mechanical data

Dim.	mm		
	Min.	Typ.	Max.
A	0.80		1.10
A1	0		0.10
A2	0.80	0.90	1
b	0.15		0.30
c	0.10		0.22
D	1.80	2	2.20
E	1.80	2.10	2.40
E1	1.15	1.25	1.35
e		0.65	
e1		130	
L	0.26	0.36	0.46
<	0°		8°

Figure 13. SOT23-3L recommended footprint



5.2 SOT323-5L package information
Figure 14. SOT323-5L package outline

Table 5. SOT323-5L mechanical data

Dim.	mm		
	Min.	Typ.	Max.
A	0.89		1.12
A1	0.013		0.10
A2	0.88	0.95	1.2
b	0.37		0.50
b1	0.37	0.40	0.45
c	0.085		0.18
c1	0.085		0.16
D	2.80	2.90	3.04
E	2.10		2.64
E1	1.20	1.30	1.40
e		0.95 BSC	
e1		1.90 BSC	
L	0.28	0.38	0.48
L1	0.55 REF		
L2			
R	0.05		
R1	0.05		
θ	0°		8°
s	0.45		0.60

Figure 15. SOT323-5L recommended footprint

5.3 SOT23-3L packing information
Figure 16. SOT23-3L tape outline

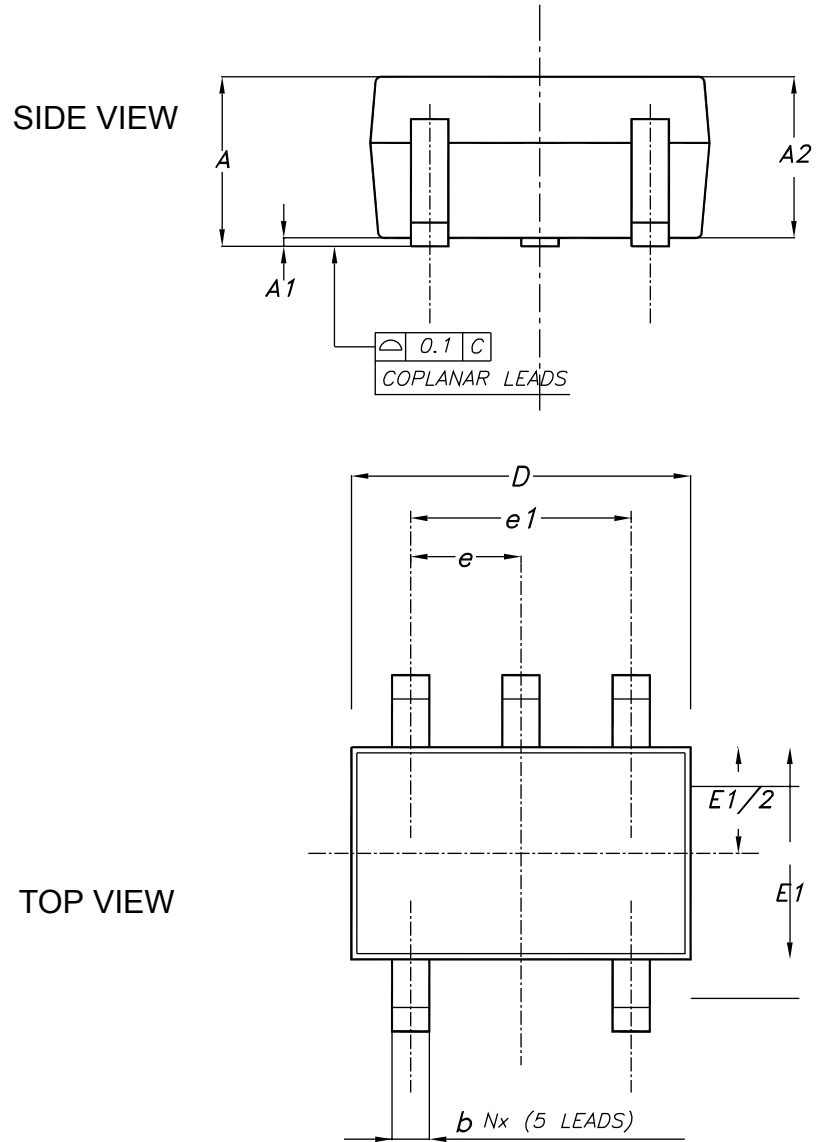
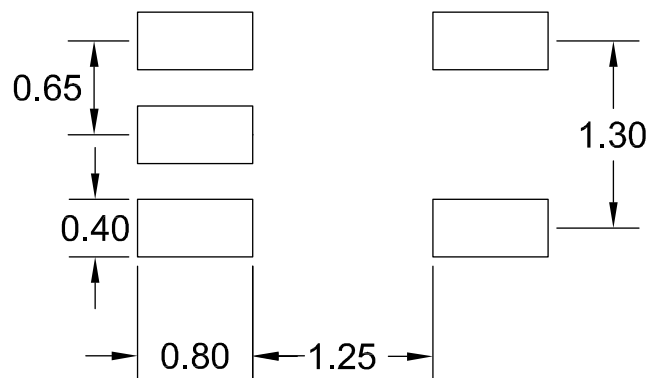
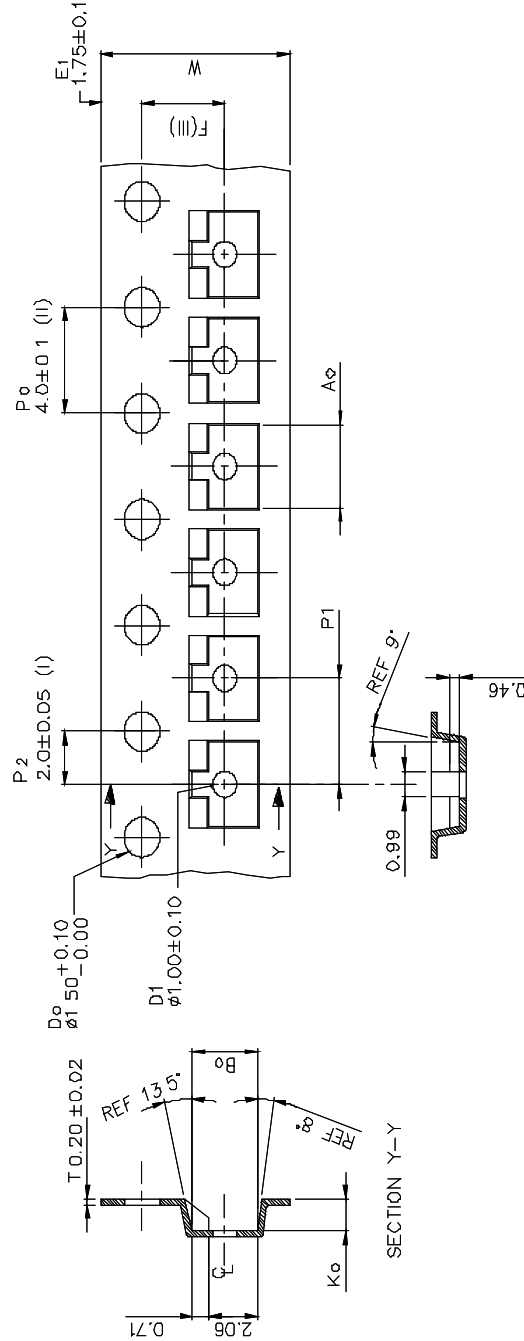
- (I) Measured from centreline of sprocket hole to centreline of pocket.
- (II) Cumulative tolerance of 10 sprocket holes is ± 0.20 .
- (III) Measured from centreline of sprocket hole to centreline of pocket.
- (IV) Other material available.
- (V) Typical SR of form tape Max. 10 μ OHM/SR

ALL DIMENSIONS IN MILLIMETRES UNLESS OTHERWISE STATED.

A_0	3.15 ± 0.10
B_0	2.77 ± 0.10
K_0	1.22 ± 0.10
F	3.50 ± 0.05
P_1	4.00 ± 0.10
W	$8.00 \pm 0.3 / -0.1$

Figure 17. SOT23-3L reel drawing

Figure 18. SOT23-3L tape direction



5.4 SOT323-5L packing information

Figure 19. SOT323-5L tape outline

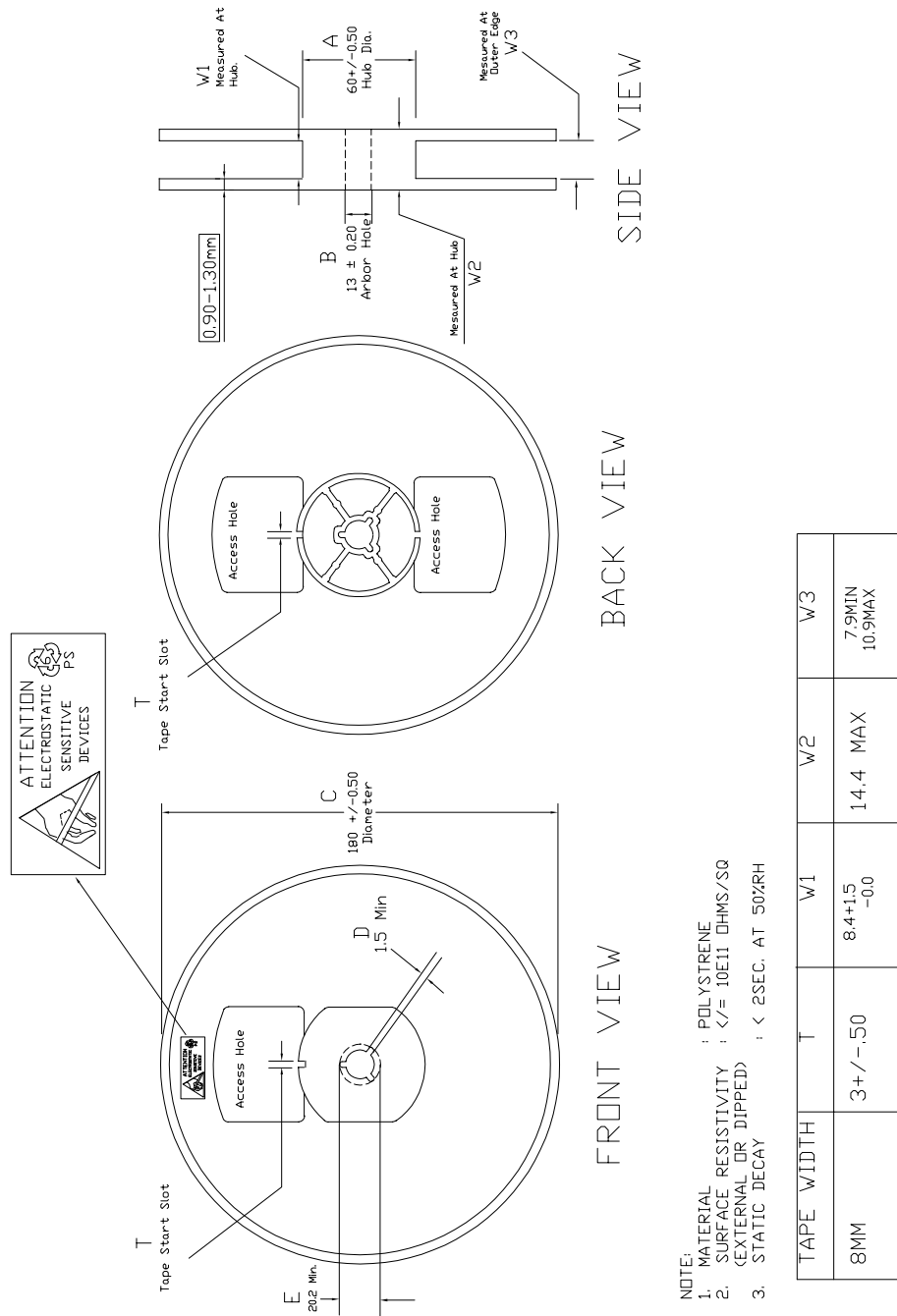
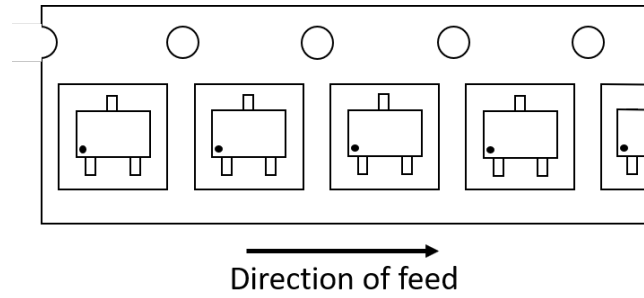
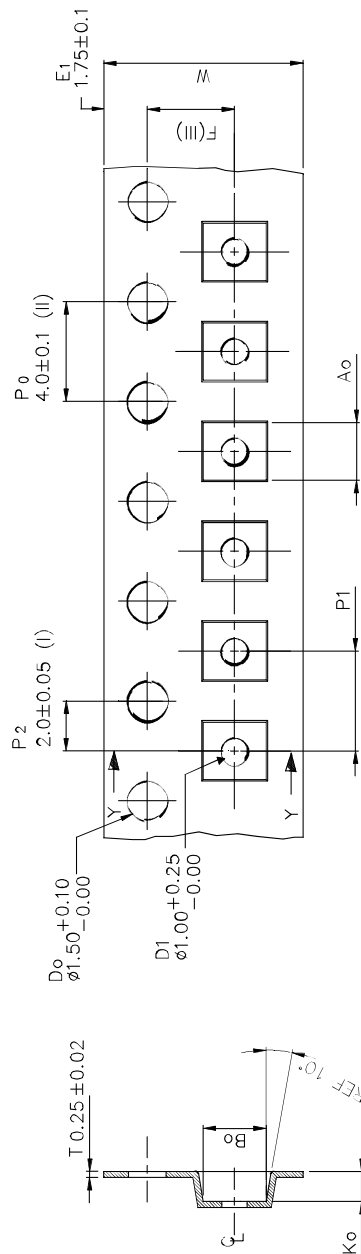

- (I) Measured from centreline of sprocket hole to centreline of pocket.
 - (II) Cumulative tolerance of 10 sprocket holes is ± 0.20 .
 - (III) Measured from centreline of sprocket hole to centreline of pocket.
 - (IV) Other material available.
 - (V) Typical SR of form tape to be $10^4 \leq SR < 10^{11}$ OHMS.
- ALL DIMENSIONS IN MILLIMETRES UNLESS OTHERWISE STATED.

Ao	2.25 + / - 0.10
B0	2.45 + / - 0.10
Ko	1.20 + / - 0.10
F	3.50 + / - 0.05
P1	4.00 + / - 0.10
W	8.00 + 0.3 / - 0.1

Figure 20. SOT323-5L reel drawing

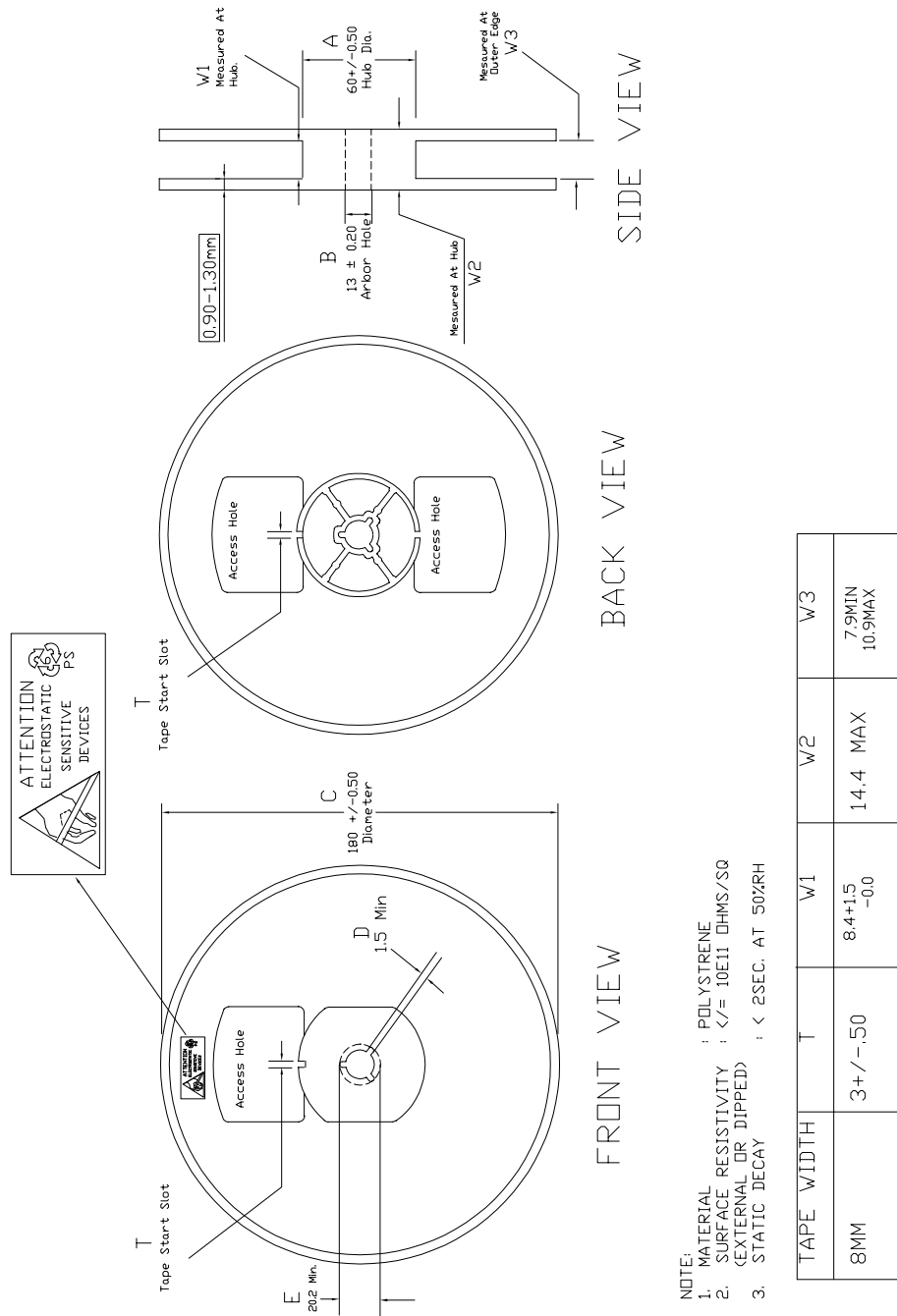
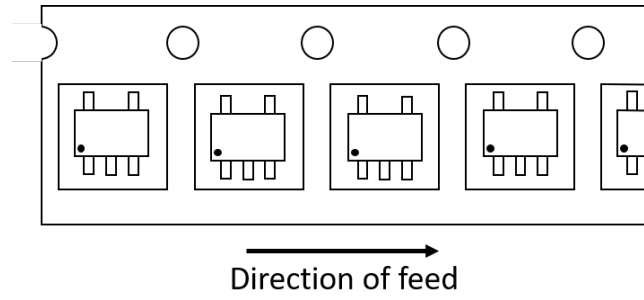

Figure 21. SOT323-5L tape direction



6 Ordering information

Order codes	Precision (%)	Package	Output voltage (V)	Marking	Temperature range (°C)
LM4040AELT-2.0	0.1%	SOT23-3L	2.048	A20	-40°C to +125°C
LM4040BELT-2.0	0.2%	SOT23-3L	2.048	B20	-40°C to +125°C
LM4040CELT-2.0	0.5%	SOT23-3L	2.048	C20	-40°C to +125°C
LM4040DELT-2.0	1.0%	SOT23-3L	2.048	D20	-40°C to +125°C
LM4040AECT-2.0	0.1%	SOT323-5L	2.048	A20	-40°C to +125°C
LM4040BECT-2.0	0.2%	SOT323-5L	2.048	A20	-40°C to +125°C
LM4040CECT-2.0	0.5%	SOT323-5L	2.048	C20	-40°C to +125°C
LM4040DECT-2.0	1.0%	SOT323-5L	2.048	D20	-40°C to +125°C
LM4040AELT-2.5	0.1%	SOT23-3L	2.5	A25	-40°C to +125°C
LM4040BELT-2.5	0.2%	SOT23-3L	2.5	B25	-40°C to +125°C
LM4040CELT-2.5	0.5%	SOT23-3L	2.5	C25	-40°C to +125°C
LM4040DELT-2.5	1.0%	SOT23-3L	2.5	D25	-40°C to +125°C
LM4040AECT-2.5	0.1%	SOT323-5L	2.5	A25	-40°C to +125°C
LM4040BECT-2.5	0.2%	SOT323-5L	2.5	A25	-40°C to +125°C
LM4040CECT-2.5	0.5%	SOT323-5L	2.5	C25	-40°C to +125°C
LM4040DECT-2.5	1.0%	SOT323-5L	2.5	D25	-40°C to +125°C
LM4040AELT-3.0	0.1%	SOT23-3L	3.0	A30	-40°C to +125°C
LM4040BELT-3.0	0.2%	SOT23-3L	3.0	B30	-40°C to +125°C
LM4040CELT-3.0	0.5%	SOT23-3L	3.0	C30	-40°C to +125°C
LM4040DELT-3.0	1.0%	SOT23-3L	3.0	D30	-40°C to +125°C
LM4040AECT-3.0	0.1%	SOT323-5L	3.0	A30	-40°C to +125°C
LM4040BECT-3.0	0.2%	SOT323-5L	3.0	A30	-40°C to +125°C
LM4040CECT-3.0	0.5%	SOT323-5L	3.0	C30	-40°C to +125°C
LM4040DECT-3.0	1.0%	SOT323-5L	3.0	D30	-40°C to +125°C
LM4040AELT-4.1	0.1%	SOT23-3L	4.096	A40	-40°C to +125°C
LM4040BELT-4.1	0.2%	SOT23-3L	4.096	B40	-40°C to +125°C
LM4040CELT-4.1	0.5%	SOT23-3L	4.096	C40	-40°C to +125°C
LM4040DELT-4.1	1.0%	SOT23-3L	4.096	D40	-40°C to +125°C
LM4040AECT-4.1	0.1%	SOT323-5L	4.096	A40	-40°C to +125°C
LM4040BECT-4.1	0.2%	SOT323-5L	4.096	A40	-40°C to +125°C
LM4040CECT-4.1	0.5%	SOT323-5L	4.096	C40	-40°C to +125°C
LM4040DECT-4.1	1.0%	SOT323-5L	4.096	D40	-40°C to +125°C
LM4040AELT-5.0	0.1%	SOT23-3L	5.0	A50	-40°C to +125°C
LM4040BELT-5.0	0.2%	SOT23-3L	5.0	B50	-40°C to +125°C
LM4040CELT-5.0	0.5%	SOT23-3L	5.0	C50	-40°C to +125°C
LM4040DELT-5.0	1.0%	SOT23-3L	5.0	D50	-40°C to +125°C
LM4040AECT-5.0	0.1%	SOT323-5L	5.0	A50	-40°C to +125°C
LM4040BECT-5.0	0.2%	SOT323-5L	5.0	A50	-40°C to +125°C

Order codes	Precision (%)	Package	Output voltage (V)	Marking	Temperature range (°C)
LM4040CECT-5.0	0.5%	SOT323-5L	5.0	C50	-40°C to +125°C
LM4040DECT-5.0	1.0%	SOT323-5L	5.0	D50	-40°C to +125°C

Revision history

Table 6. Document revision history

Date	Version	Changes
26-Jan-2021	1	First release.

Contents

1	Pin configuration	2
2	Maximum ratings	3
3	Electrical characteristics	4
4	Typical performance characteristics	5
5	Package information	7
5.1	SOT23-3L package information	7
5.2	SOT323-5L package information	9
5.3	SOT23-3L packing information	11
5.4	SOT323-5L packing information	13
6	Ordering information	16
	Revision history	18

List of tables

Table 1.	Absolute maximum ratings	3
Table 2.	Thermal data	3
Table 3.	Operating conditions	3
Table 4.	SOT23-3L mechanical data	8
Table 5.	SOT323-5L mechanical data	10
Table 6.	Document revision history	18

List of figures

Figure 1.	Pin configuration SOT23-3L, SOT323-5L (top view)	2
Figure 2.	V_K change vs. temperature (5 V version)	5
Figure 3.	V_K change vs. temperature (5 V version)	5
Figure 4.	I_{Kmin} minimum current for regulation	5
Figure 5.	Low frequency noise test	5
Figure 6.	Measured dynamic impedance	5
Figure 7.	Forward characteristics	5
Figure 8.	Turn-on time setting (no Cload)	6
Figure 9.	Turn-on time setting (Cload = 100 nF)	6
Figure 10.	Turn-on time setting (Cload = 1 μ F)	6
Figure 11.	Stability plane vs. Cout	6
Figure 12.	SOT23-3L package outline	7
Figure 13.	SOT23-3L recommended footprint	8
Figure 14.	SOT323-5L package outline	9
Figure 15.	SOT323-5L recommended footprint	10
Figure 16.	SOT23-3L tape outline	11
Figure 17.	SOT23-3L reel drawing	12
Figure 18.	SOT23-3L tape direction	13
Figure 19.	SOT323-5L tape outline	13
Figure 20.	SOT323-5L reel drawing	14
Figure 21.	SOT323-5L tape direction	15