

## 16 V CMOS dual rail-to-rail input and output, operational amplifiers

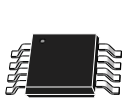

MiniSO8

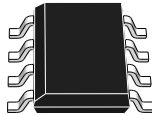

SO8

### Features

- Low input offset voltage: 2 mV max.
- Rail-to-rail input and output
- Excellent CMRR : 98 dB @ 16 V
- Low current consumption: 900  $\mu$ A max.
- Gain bandwidth product: 2.7 MHz
- Low supply voltage: 2.7 - 16 V
- Unity gain stable
- Low input bias current: 50 pA max.
- High ESD tolerance: 4 kV HBM
- Extended temp. range: -40 °C to +125 °C

### Applications

- Data acquisition systems
- Battery-powered instrumentation
- Instrumentation amplifier
- Active filtering
- DAC buffer
- High-impedance sensor interface
- Current sensing (high and low side)

Maturity status link

[LMC6482](#)

### Description

The [LMC6482](#) offer rail-to-rail input and output functionality allowing this product to be used on full range input and output without limitation.

This rail to rail capability combined with excellent accuracy makes this device ideal for systems such as data acquisition, that require wide input signal range.

This is particularly useful for a low-voltage supply such as 2.7 V that the [LMC6482](#) is able to operate with.

Thus, the [LMC6482](#) has the great advantage of offering a large span of supply voltages, ranging from 2.7 V to 16 V. It can be used in multiple applications with a unique reference.

Low input bias current performance makes the [LMC6482](#) perfect when used for signal conditioning in sensor interface applications. In addition, low- side and high-side current measurements can be easily made thanks to rail-to-rail functionality.

# 1 Pin configuration

Figure 1. Pin connection (top view)

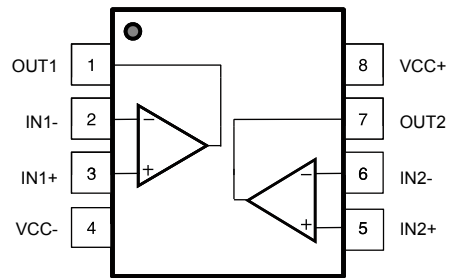

## 2 Absolute maximum ratings and operating conditions

**Table 1. Absolute maximum ratings**

| Symbol     | Parameter  | Value                                  | Unit |      |
|------------|--|--|------|------|
| $V_{CC}$   | Supply voltage <sup>(1)</sup>                            | 18                                     | V    |      |
| $V_{id}$   | Differential input voltage <sup>(2)</sup>                | $\pm V_{CC}$                           | mV   |      |
| $V_{in}$   | Input voltage  | $(V_{CC-}) - 0.2$ to $(V_{CC+}) + 0.2$ | V    |      |
| $I_{in}$   | Input current <sup>(3)</sup>                             | 10                                     | mA   |      |
| $T_{stg}$  | Storage temperature                                      | -65 to 150                             | °C   |      |
| $R_{thja}$ | Thermal resistance junction to ambient <sup>(4)(5)</sup> | MiniSO8                                | 190  | °C/W |
|            |  | SO-8                                   | 125  |      |
| $T_j$      | Maximum junction temperature                             | 150                                    | °C   |      |
| ESD        | HBM: Human body model <sup>(6)</sup>                     | 4000                                   | V    |      |
|            | MM: machine model <sup>(7)</sup>                         | 100                                    |      |      |
|            | CDM: charged device model <sup>(8)</sup>                 | 1500                                   |      |      |
|            | Latch-up immunity  | 200                                    | mA   |      |

1. All voltage values, except the differential voltage are with respect to the network ground terminal.
2. Differential voltages are the non-inverting input terminal with respect to the inverting input terminal. See for the precautions to follow when using LMC6482 with a high differential input voltage.
3. Input current must be limited by a resistor in series with the inputs.
4.  $R_{th}$  are typical values.
5. Short-circuits can cause excessive heating and destructive dissipation.
6. According to JEDEC standard JESD22-A114F.
7. According to JEDEC standard JESD22-A115A.
8. According to ANSI/ESD STM5.3.1.

**Table 2. Operating conditions**

| Symbol     | Parameter                            | Value                                  | Unit |
|------------|--------------------------------------|--|------|
| $V_{CC}$   | Supply voltage                       | 2.7 to 16                              | V    |
| $V_{icm}$  | Common mode input voltage range      | $(V_{CC-}) - 0.1$ to $(V_{CC+}) + 0.1$ |      |
| $T_{oper}$ | Operating free air temperature range | -40 to +125                            | °C   |

### 3 Electrical characteristics

$V_{CC+} = +4\text{ V}$  with  $V_{CC-} = 0\text{ V}$ ,  $V_{icm} = V_{CC}/2$ ,  $T_{amb} = 25\text{ }^{\circ}\text{C}$ , and  $R_L > 10\text{ k}\Omega$  connected to  $V_{CC}/2$  (unless otherwise specified).

**Table 3. Electrical characteristics**

| Symbol                   | Parameter   | Conditions   | Min. | Typ. | Max. | Unit                                    |
|--------------------------|---|--|------|------|------|---|
| $V_{io}$                 | Input offset voltage  | $V_{icm} = V_{CC}/2$   |      |      | 2    | mV                                      |
|                          |   | $T_{min} < T_{op} < T_{max}$                                       |      |      | 2.5  |   |
| $\Delta V_{io}/\Delta T$ | Input offset voltage drift <sup>(1)</sup>                           |  |      |      | 5    | $\mu\text{V}/^{\circ}\text{C}$          |
| $\Delta V_{io}$          | Long term input offset voltage drift <sup>(2)</sup>                 | $T = 25\text{ }^{\circ}\text{C}$                                   |      | 1    |      | $\frac{\text{nV}}{\sqrt{\text{month}}}$ |
| $I_{ib}$                 | Input bias current <sup>(1)</sup>                                   | $V_{out} = V_{CC}/2$   |      | 1    | 50   | pA                                      |
|                          |   | $T_{min} < T_{op} < T_{max}$                                       |      |      | 200  |   |
| $I_{io}$                 | Input offset current <sup>(1)</sup>                                 | $V_{out} = V_{CC}/2$   |      | 1    | 50   | pA                                      |
|                          |   | $T_{min} < T_{op} < T_{max}$                                       |      |      | 200  |   |
| $R_{IN}$                 | Input resistance  |  |      | 1    |      | T $\Omega$                              |
| $C_{IN}$                 | Input capacitance   |  |      | 12.5 |      | pF                                      |
| CMRR                     | Common mode rejection ratio $20 \log (\Delta V_{ic}/\Delta V_{io})$ | $V_{icm} = -0.1\text{ to }4.1\text{ V}$ , $V_{out} = V_{CC}/2$     | 65   | 85   |      | dB                                      |
|                          |   | $T_{min} < T_{op} < T_{max}$                                       | 60   |      |      |   |
| $A_{vd}$                 | Large signal voltage gain   | $R_L = 2\text{ k}\Omega$ , $V_{out} = 0.3\text{ to }3.7\text{ V}$  | 85   | 136  |      | dB                                      |
|                          |   | $T_{min} < T_{op} < T_{max}$                                       | 80   |      |      |   |
|                          |   | $R_L = 10\text{ k}\Omega$ , $V_{out} = 0.2\text{ to }3.8\text{ V}$ | 85   | 140  |      |   |
|                          |   | $T_{min} < T_{op} < T_{max}$                                       | 80   |      |      |   |
| $V_{OH}$                 | High level output voltage<br>(voltage drop from $V_{CC+}$ )         | $R_L = 2\text{ k}\Omega$ to $V_{CC}/2$                             |      | 28   | 50   | mV                                      |
|                          |   | $T_{min} < T_{op} < T_{max}$                                       |      |      | 60   |   |
|                          |   | $R_L = 10\text{ k}\Omega$ to $V_{CC}/2$                            |      | 6    | 15   |   |
|                          |   | $T_{min} < T_{op} < T_{max}$                                       |      |      | 20   |   |
| $V_{OL}$                 | Low level output voltage  | $R_L = 2\text{ k}\Omega$ to $V_{CC}/2$                             |      | 23   | 50   | mV                                      |
|                          |   | $T_{min} < T_{op} < T_{max}$                                       |      |      | 60   |   |
|                          |   | $R_L = 10\text{ k}\Omega$ to $V_{CC}/2$                            |      | 5    | 15   |   |
|                          |   | $T_{min} < T_{op} < T_{max}$                                       |      |      | 20   |   |
| $I_{out}$                | $I_{sink}$  | $V_{out} = V_{CC}$   | 25   | 37   |      | mA                                      |
|                          |   | $T_{min} < T_{op} < T_{max}$                                       | 15   |      |      |   |
|                          | $I_{source}$  | $V_{out} = 0\text{ V}$   | 35   | 45   |      |   |
|                          |   | $T_{min} < T_{op} < T_{max}$                                       | 20   |      |      |   |
| $I_{CC}$                 | Supply current per amplifier  | No load, $V_{out} = V_{CC}/2$                                      |      | 570  | 800  | $\mu\text{A}$                           |
|                          |   | $T_{min} < T_{op} < T_{max}$                                       |      |      | 900  |   |
| GBP                      | Gain bandwidth product  | $R_L = 10\text{ k}\Omega$ , $C_L = 100\text{ pF}$                  | 1.9  | 2.7  |      | MHz                                     |

| Symbol   | Parameter                         | Conditions   | Min. | Typ.  | Max. | Unit                   |
|----------|-----------------------------------|--|------|-------|------|------------------------|
| $\phi_m$ | Phase margin                      | $R_L = 10\text{ k}\Omega, C_L = 100\text{ pF}$   |      | 50    |      | Degrees                |
| Gm       | Gain margin                       | $R_L = 10\text{ k}\Omega, C_L = 100\text{ pF}$   |      | 15    |      | dB                     |
| SRn      | Negative slew rate                | $A_v = 1, V_{out} = 3 V_{PP}, 10\% \text{ to } 90\%$   | 0.6  | 0.85  |      | V/ $\mu$ s             |
|          |                                   | $T_{min} < T_{op} < T_{max}$   | 0.5  |       |      |                        |
| SRp      | Positive slew rate                | $A_v = 1, V_{out} = 3 V_{PP}, 10\% \text{ to } 90\%$   | 1.0  | 1.4   |      |                        |
|          |                                   | $T_{min} < T_{op} < T_{max}$   | 0.9  |       |      |                        |
| $e_n$    | Equivalent input noise voltage    | $f = 1\text{ kHz}$   |      | 22    |      | $\frac{nV}{\sqrt{Hz}}$ |
|          |                                   | $f = 10\text{ kHz}$  |      | 19    |      |                        |
| THD+N    | Total harmonic distortion + noise | $f = 1\text{ kHz}, A_v = 1, R_L = 10\text{ k}\Omega,$<br>$BW = 22\text{ kHz}, V_{in} = 0.8 V_{PP}$ |      | 0.001 |      | %                      |

1. Maximum values are guaranteed by design.
2. Typical value is based on the  $V_{io}$  drift observed after 1000h at 125 °C extrapolated to 25 °C using the Arrhenius law and assuming an activation energy of 0.7 eV. The operational amplifier is aged in follower mode configuration (see [Section 5.6 Long term input offset voltage drift](#)).

$V_{CC+} = +10\text{ V}$  with  $V_{CC-} = 0\text{ V}$ ,  $V_{icm} = V_{CC}/2$ ,  $T_{amb} = 25\text{ }^\circ\text{C}$ , and  $R_L > 10\text{ k}\Omega$  connected to  $V_{CC}/2$  (unless otherwise specified).

**Table 4. Electrical characteristics**

| Symbol                   | Parameter  | Conditions  | Min. | Typ. | Max. | Unit                             |
|--------------------------|--|---|------|------|------|----------------------------------|
| $V_{io}$                 | Input offset voltage   | $V_{icm} = V_{CC}/2$  |      |      | 2    | mV                               |
|                          |  | $T_{min} < T_{op} < T_{max}$                                      |      |      | 2.5  |                                  |
| $\Delta V_{io}/\Delta T$ | Input offset voltage drift <sup>(1)</sup>                          |   |      |      | 5    | $\mu\text{V}/^\circ\text{C}$     |
| $\Delta V_{io}$          | Longterm input offset voltage drift <sup>(2)</sup>                 | $T = 25\text{ }^\circ\text{C}$                                    |      | 25   |      | $\frac{nV}{\sqrt{\text{month}}}$ |
| $I_{ib}$                 | Input bias current <sup>(1)</sup>                                  | $V_{out} = V_{CC}/2$  |      | 1    | 50   | pA                               |
|                          |  | $T_{min} < T_{op} < T_{max}$                                      |      |      | 200  |                                  |
| $I_{io}$                 | Input offset current <sup>(1)</sup>                                | $V_{out} = V_{CC}/2$  |      | 1    | 50   |                                  |
|                          |  | $T_{min} < T_{op} < T_{max}$                                      |      |      | 200  |                                  |
| $R_{IN}$                 | Input resistance   |   |      | 1    |      | T $\Omega$                       |
| $C_{IN}$                 | Input capacitance  |   |      | 12.5 |      | pF                               |
| CMRR                     | Common mode rejectionratio $20 \log (\Delta V_{ic}/\Delta V_{io})$ | $V_{icm} = -0.1 \text{ to } 10.1\text{ V}, V_{out} = V_{CC}/2$    | 72   | 92   |      | dB                               |
|                          |  | $T_{min} < T_{op} < T_{max}$                                      | 67   |      |      |                                  |
| $A_{vd}$                 | Large signal voltage gain  | $R_L = 2\text{ k}\Omega, V_{out} = 0.3 \text{ to } 9.7\text{ V}$  | 90   | 140  |      |                                  |
|                          |  | $T_{min} < T_{op} < T_{max}$                                      | 85   |      |      |                                  |
|                          |  | $R_L = 10\text{ k}\Omega, V_{out} = 0.2 \text{ to } 9.8\text{ V}$ | 90   |      |      |                                  |
|                          |  | $T_{min} < T_{op} < T_{max}$                                      | 85   |      |      |                                  |

| Symbol    | Parameter   | Conditions  | Min. | Typ.   | Max. | Unit                   |
|-----------|---|---|------|--------|------|------------------------|
| $V_{OH}$  | High level output voltage<br>(voltage drop from $V_{CC+}$ ) | $R_L = 2\text{ k}\Omega$ to $V_{CC}/2$  |      | 45     | 70   | mV                     |
|           |   | $T_{min} < T_{op} < T_{max}$  |      |        | 80   |                        |
|           |   | $R_L = 10\text{ k}\Omega$ to $V_{CC}/2$   |      | 10     | 30   |                        |
|           |   | $T_{min} < T_{op} < T_{max}$  |      |        | 40   |                        |
| $V_{OL}$  | Low level output voltage                                    | $R_L = 2\text{ k}\Omega$ to $V_{CC}/2$  |      | 42     | 70   | mV                     |
|           |   | $T_{min} < T_{op} < T_{max}$  |      |        | 80   |                        |
|           |   | $R_L = 10\text{ k}\Omega$ to $V_{CC}/2$   |      | 9      | 30   |                        |
|           |   | $T_{min} < T_{op} < T_{max}$  |      |        | 40   |                        |
| $I_{out}$ | $I_{sink}$  | $V_{out} = V_{CC}$  | 30   | 39     |      | mA                     |
|           |   | $T_{min} < T_{op} < T_{max}$  | 15   |        |      |                        |
|           | $I_{source}$  | $V_{out} = 0\text{ V}$  | 50   | 69     |      |                        |
|           |   | $T_{min} < T_{op} < T_{max}$  | 40   |        |      |                        |
| $I_{CC}$  | Supply current per amplifier                                | No load, $V_{out} = V_{CC}/2$   |      | 630    | 850  | $\mu\text{A}$          |
|           |   | $T_{min} < T_{op} < T_{max}$  |      |        | 1000 |                        |
| GBP       | Gain bandwidth product                                      | $R_L = 10\text{ k}\Omega$ , $C_L = 100\text{ pF}$   | 1.9  | 2.7    |      | MHz                    |
| $\phi_m$  | Phase margin  | $R_L = 10\text{ k}\Omega$ , $C_L = 100\text{ pF}$   |      | 53     |      | Degrees                |
| Gm        | Gain margin   | $R_L = 10\text{ k}\Omega$ , $C_L = 100\text{ pF}$   |      | 15     |      | dB                     |
| SRn       | Negative slew rate  | $A_v = 1$ , $V_{out} = 8\text{ V}_{PP}$ , 10% to 90%  | 0.8  | 1      |      | V/ $\mu\text{s}$       |
|           |   | $T_{min} < T_{op} < T_{max}$  | 0.7  |        |      |                        |
| SRp       | Positive slew rate  | $A_v = 1$ , $V_{out} = 8\text{ V}_{PP}$ , 10% to 90%  | 1.0  | 1.3    |      |                        |
|           |   | $T_{min} < T_{op} < T_{max}$  | 0.9  |        |      |                        |
| $e_n$     | Equivalent input noise voltage                              | $f = 1\text{ kHz}$  |      | 22     |      | $\frac{nV}{\sqrt{Hz}}$ |
|           |   | $f = 10\text{ kHz}$   |      | 19     |      |                        |
| THD+N     | Total harmonic distortion + noise                           | $f = 1\text{ kHz}$ , $A_v = 1$ , $R_L = 10\text{ k}\Omega$ ,<br>$BW = 22\text{ kHz}$ , $V_{in} = 5\text{ V}_{PP}$ |      | 0.0003 |      | %                      |

1. Maximum values are guaranteed by design.
2. Typical value is based on the  $V_{io}$  drift observed after 1000h at 125 °C extrapolated to 25 °C using the Arrhenius law and assuming an activation energy of 0.7 eV. The operational amplifier is aged in follower mode configuration (see [Section 5.6 Long term input offset voltage drift](#)).

$V_{CC+} = +16\text{ V}$  with  $V_{CC-} = 0\text{ V}$ ,  $V_{icm} = V_{CC}/2$ ,  $T_{amb} = 25\text{ }^{\circ}\text{C}$ , and  $R_L > 10\text{ k}\Omega$  connected to  $V_{CC}/2$  (unless otherwise specified).

**Table 5. Electrical characteristics**

| Symbol                   | Parameter  | Conditions   | Min. | Typ. | Max. | Unit                                    |
|--------------------------|--|--|------|------|------|---|
| $V_{io}$                 | Input offset voltage   | $V_{icm} = V_{CC}/2$   |      |      | 2    | mV                                      |
|                          |  | $T_{min} < T_{op} < T_{max}$                                   |      |      | 2.5  |   |
| $\Delta V_{io}/\Delta T$ | Input offset voltage drift <sup>(1)</sup>                                  |  |      |      | 5    | $\mu\text{V}/^{\circ}\text{C}$          |
| $\Delta V_{io}$          | Longterm input offset voltage drift <sup>(2)</sup>                         | $T = 25\text{ }^{\circ}\text{C}$                               |      | 500  |      | $\frac{n\text{V}}{\sqrt{\text{month}}}$ |
| $I_{ib}$                 | Input bias current <sup>(1)</sup>  | $V_{out} = V_{CC}/2$   |      | 1    | 50   | pA                                      |
|                          |  | $T_{min} < T_{op} < T_{max}$                                   |      |      | 200  |   |
| $I_{io}$                 | Input offset current <sup>(1)</sup>  | $V_{out} = V_{CC}/2$   |      | 1    | 50   |   |
|                          |  | $T_{min} < T_{op} < T_{max}$                                   |      |      | 200  |   |
| $R_{IN}$                 | Input resistance   |  |      | 1    |      | T $\Omega$                              |
| $C_{IN}$                 | Input capacitance  |  |      | 12.5 |      | pF                                      |
| CMRR                     | Common mode rejection ratio<br>20 log ( $\Delta V_{ic}/\Delta V_{io}$ )    | $V_{icm} = -0.1$ to $16.1\text{ V}$ , $V_{out} = V_{CC}/2$     | 75   | 98   |      | dB                                      |
|                          |  | $T_{min} < T_{op} < T_{max}$                                   | 70   |      |      |   |
| SVRR                     | Supply voltage rejection ratio<br>20 log ( $\Delta V_{cc}/\Delta V_{io}$ ) | $V_{cc} = 4$ to $16\text{ V}$                                  | 100  | 131  |      |   |
|                          |  | $T_{min} < T_{op} < T_{max}$                                   | 90   |      |      |   |
| $A_{vd}$                 | Large signal voltage gain  | $R_L = 2\text{ k}\Omega$ , $V_{out} = 0.3$ to $15.7\text{ V}$  | 90   | 146  |      |   |
|                          |  | $T_{min} < T_{op} < T_{max}$                                   | 85   |      |      |   |
|                          |  | $R_L = 10\text{ k}\Omega$ , $V_{out} = 0.2$ to $15.8\text{ V}$ | 90   | 149  |      |   |
|                          |  | $T_{min} < T_{op} < T_{max}$                                   | 85   |      |      |   |
| $V_{OH}$                 | High level output voltage<br>(voltage drop from $V_{CC+}$ )                | $R_L = 2\text{ k}\Omega$ to $V/2$                              |      | 70   | 130  |   |
|                          |  | $T_{min} < T_{op} < T_{max}$                                   |      |      | 150  |   |
|                          |  | $R_L = 10\text{ k}\Omega$                                      |      | 16   | 40   |   |
|                          |  | $T_{min} < T_{op} < T_{max}$                                   |      |      | 50   |   |
| $V_{OL}$                 | Low level output voltage   | $R_L = 2\text{ k}\Omega$                                       |      | 70   | 130  |   |
|                          |  | $T_{min} < T_{op} < T_{max}$                                   |      |      | 150  |   |
|                          |  | $R_L = 10\text{ k}\Omega$                                      |      | 15   | 40   |   |
|                          |  | $T_{min} < T_{op} < T_{max}$                                   |      |      | 50   |   |
| $I_{out}$                | $I_{sink}$   | $V_{out} = V_{CC}$   | 30   | 40   |      |   |
|                          |  | $T_{min} < T_{op} < T_{max}$                                   | 15   |      |      |   |
|                          | $I_{source}$   | $V_{out} = 0\text{ V}$   | 50   | 68   |      |   |
|                          |  | $T_{min} < T_{op} < T_{max}$                                   | 45   |      |      |   |
| $I_{CC}$                 | Supply current per amplifier   | No load, $V_{out} = V_{CC}/2$                                  |      | 660  | 900  |   |
|                          |  | $T_{min} < T_{op} < T_{max}$                                   |      |      | 1000 |   |
| GBP                      | Gain bandwidth product   | $R_L = 10\text{ k}\Omega$ , $C_L = 100\text{ pF}$              | 1.9  | 2.7  |      | MHz                                     |

| Symbol   | Parameter                         | Conditions   | Min.       | Typ.   | Max. | Unit       |                        |
|----------|-----------------------------------|--|------------|--------|------|------------|------------------------|
| $\phi_m$ | Phase margin                      | $R_L = 10\text{ k}\Omega$ , $C_L = 100\text{ pF}$  |            | 55     |      | Degrees    |                        |
| Gm       | Gain margin                       | $R_L = 10\text{ k}\Omega$ , $C_L = 100\text{ pF}$  |            | 15     |      | dB         |                        |
| SRn      | Negative slew rate                | $A_v = 1$ , $V_{out} = 10\text{ V}_{PP}$ , 10 % to 90%<br>$T_{min} < T_{op} < T_{max}$         | 0.7<br>0.6 | 0.95   |      | V/ $\mu$ s |                        |
| SRp      | Positive slew rate                | $A_v = 1$ , $V_{out} = 10\text{ V}_{PP}$ , 10 % to 90%<br>$T_{min} < T_{op} < T_{max}$         | 1<br>0.9   | 1.4    |      |            |                        |
| $e_n$    | Equivalent input noise voltage    | f = 1 kHz  |            | 22     |      |            | $\frac{nV}{\sqrt{Hz}}$ |
|          |                                   | f = 10 kHz   |            | 19     |      |            |                        |
| THD+N    | Total harmonic distortion + noise | f = 1 kHz, $A_v = 1$ , $R_L = 10\text{ k}\Omega$ ,<br>BW = 22 kHz, $V_{in} = 10\text{ V}_{PP}$ |            | 0.0002 |      | %          |                        |

1. Maximum values are guaranteed by design.
2. Typical value is based on the  $V_{io}$  drift observed after 1000h at 125 °C extrapolated to 25 °C using the Arrhenius law and assuming an activation energy of 0.7 eV. The operational amplifier is aged in follower mode configuration (see [Section 5.6 Long term input offset voltage drift](#)).



## 4 Electrical characteristic curves

Figure 2. Supply current vs. supply voltage

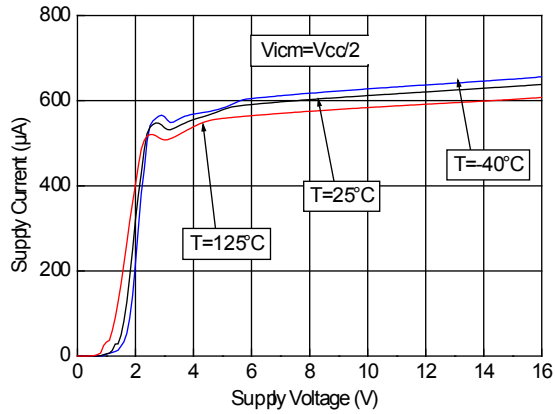

Figure 3. Input offset voltage distribution at V<sub>CC</sub> = 16 V

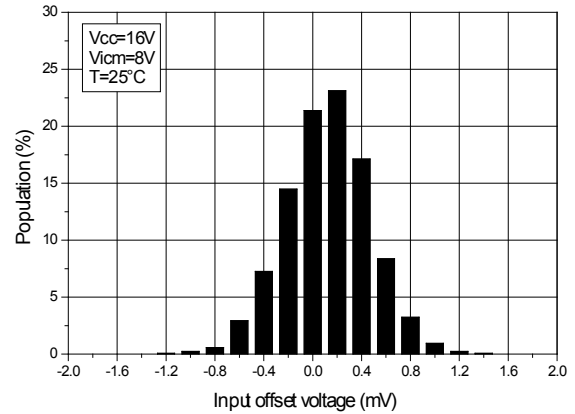

Figure 4. Input offset voltage distribution at V<sub>CC</sub> = 4 V

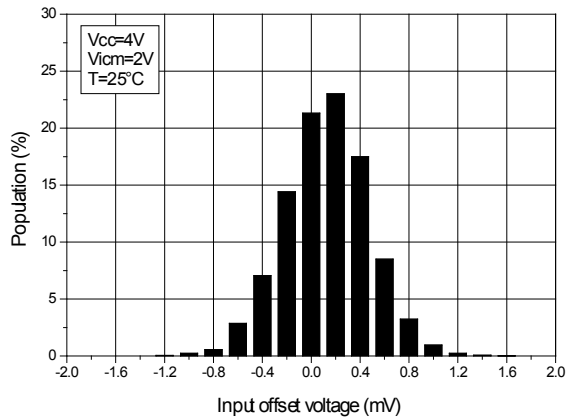
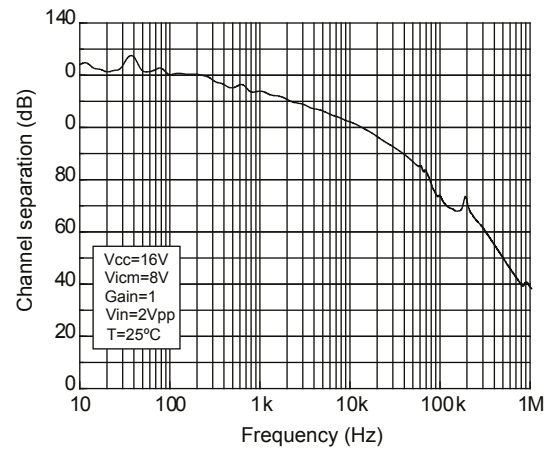

Figure 5. Channel separation



**Figure 6. Output current vs. output voltage at  $V_{CC} = 2.7\text{ V}$** 

**Figure 7. Output current vs. output voltage at  $V_{CC} = 16\text{ V}$** 

**Figure 8. Output low voltage vs. supply voltage**

**Figure 9. Output high voltage (drop from  $V_{CC+}$ ) vs. supply voltage**

**Figure 10. Output voltage vs. input voltage close to the rail at  $V_{CC} = 16\text{ V}$** 

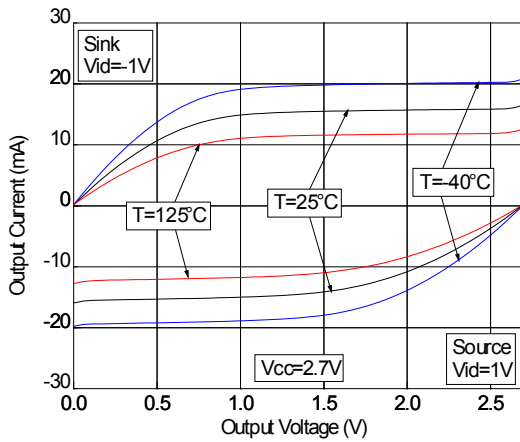
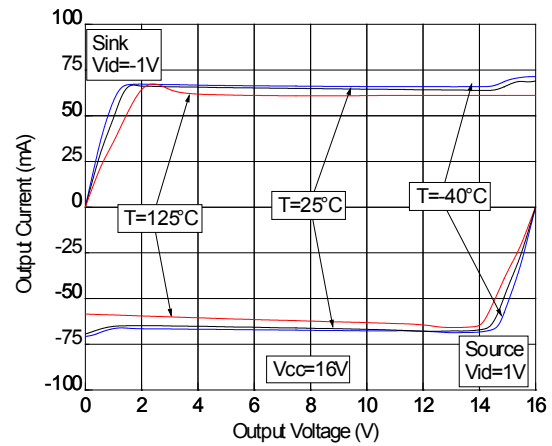
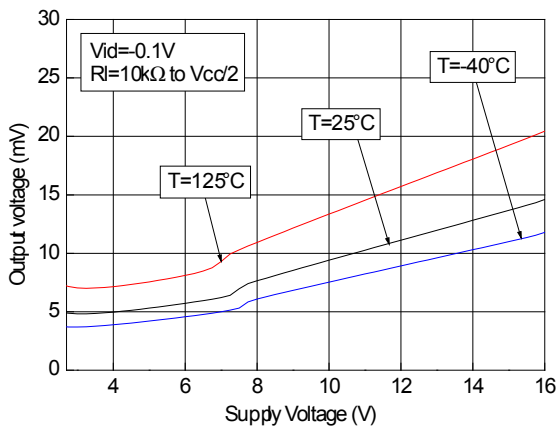
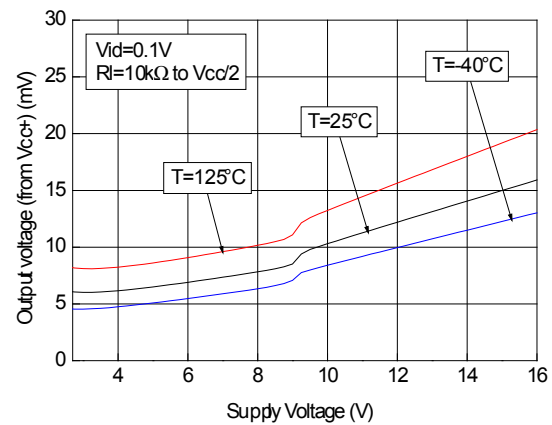
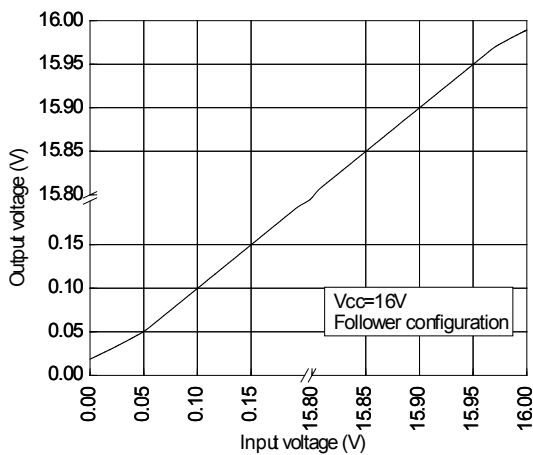
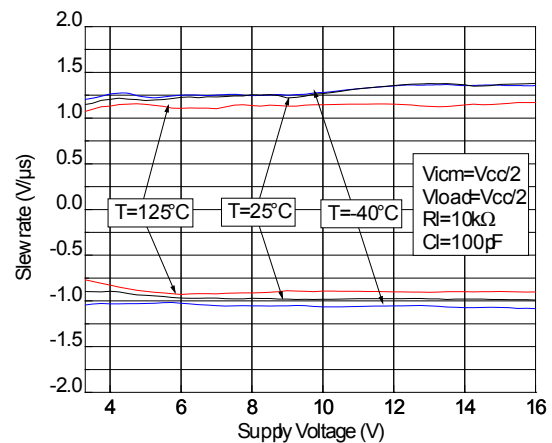
**Figure 11. Slew rate vs. supply voltage**

Figure 12. Negative slew rate at  $V_{CC} = 16\text{ V}$

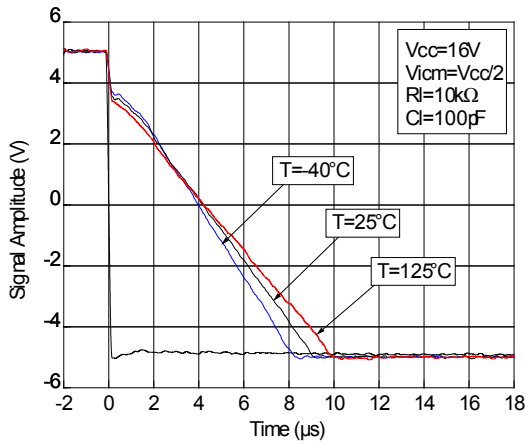

Figure 13. Positive slew rate at  $V_{CC} = 16\text{ V}$

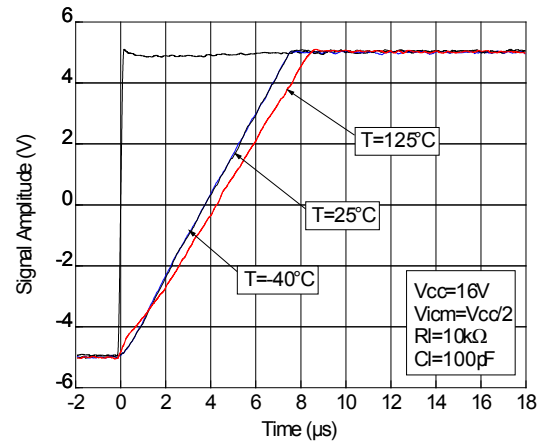

Figure 14. Response to a small input voltage step

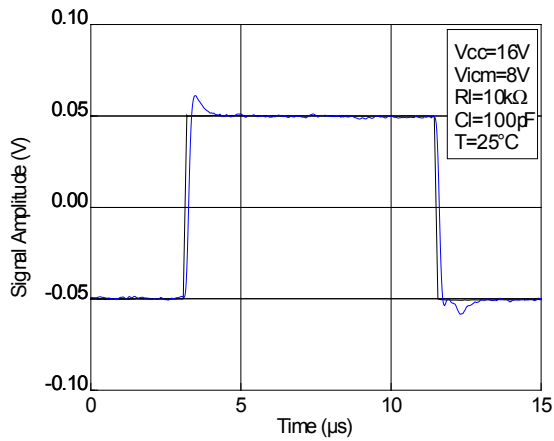

Figure 15. Recovery behavior after a negative step on the input

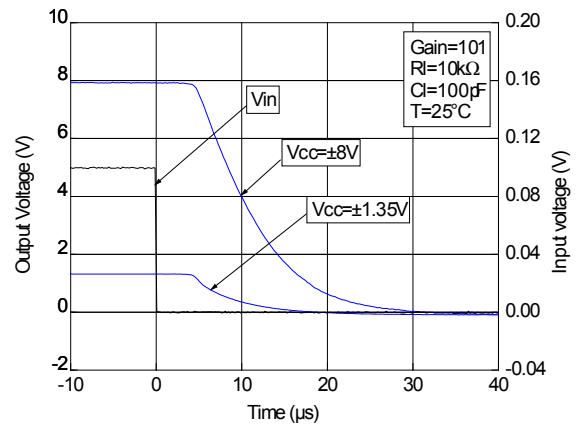

Figure 16. Recovery behavior after a positive step on the input

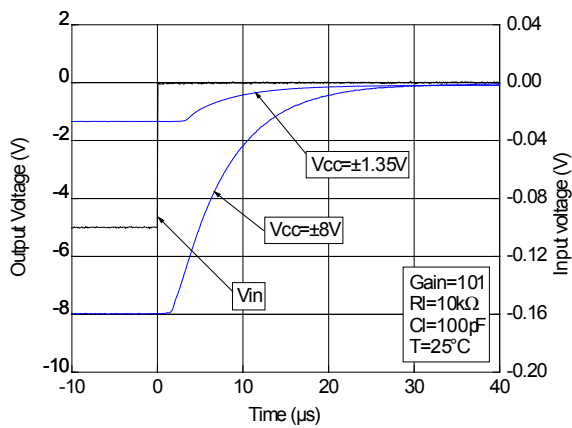

Figure 17. Bode diagram at  $V_{CC} = 2.7\text{ V}$

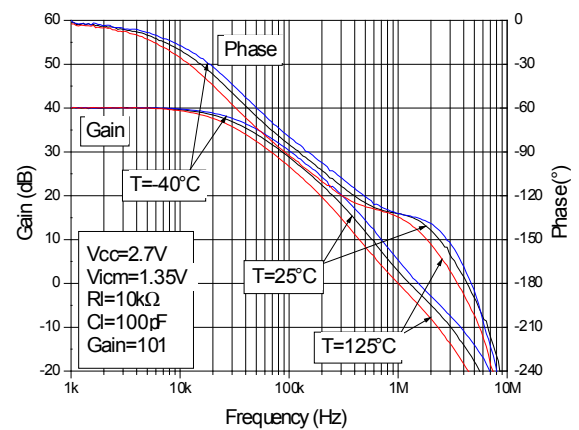

Figure 18. Bode diagram at  $V_{CC} = 16\text{ V}$

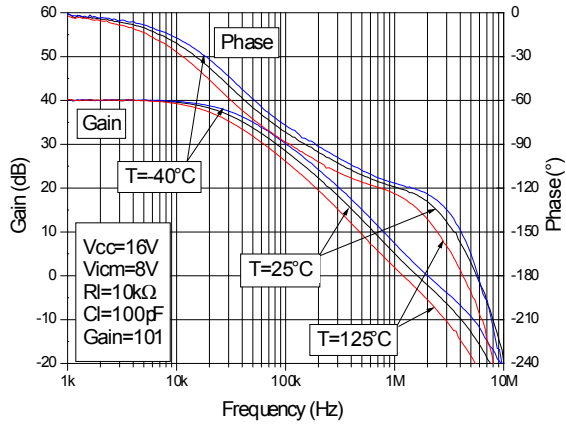

Figure 19. Power supply rejection ratio (PSRR) vs. frequency

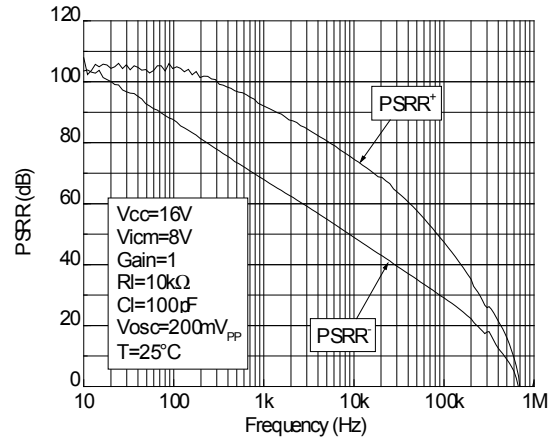

Figure 20. Output overshoot vs. capacitive load

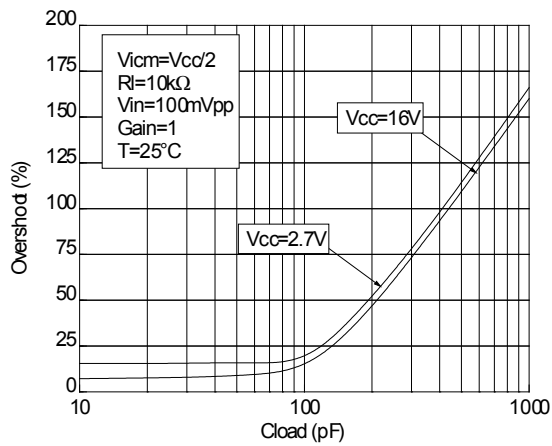

Figure 21. Output impedance vs. frequency in closed loop configuration

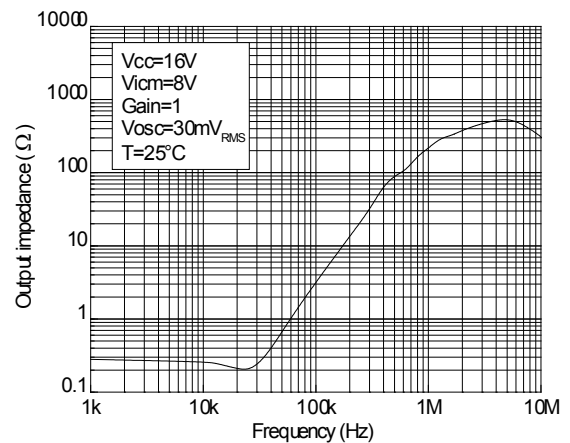

Figure 22. THD + N vs. frequency

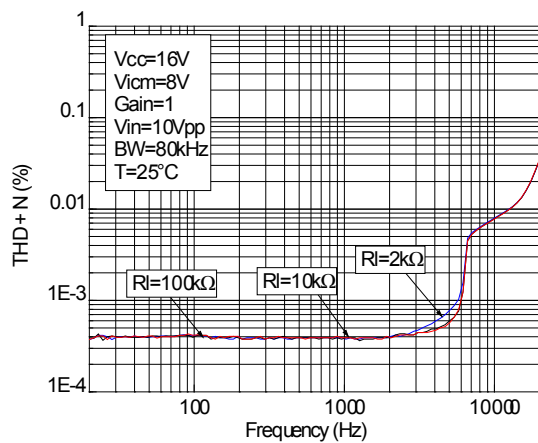

Figure 23. THD + N vs. output voltage

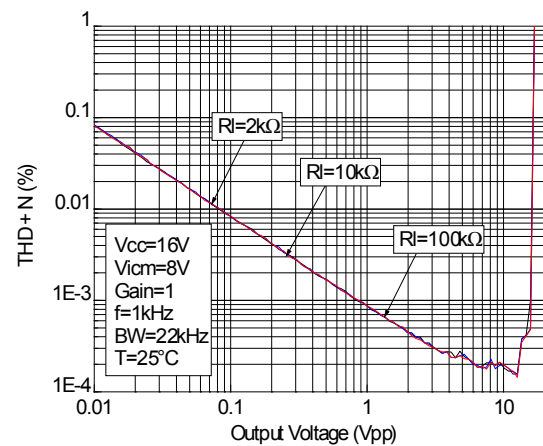

Figure 24. Noise vs. frequency

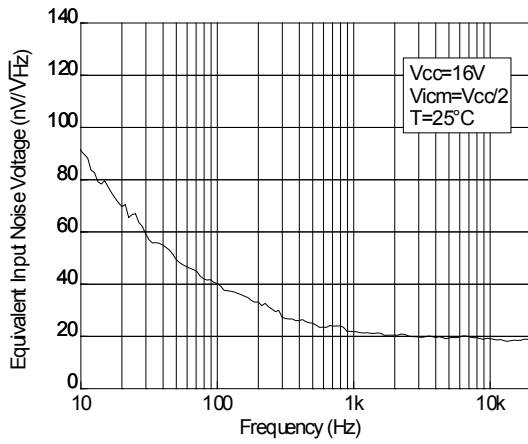
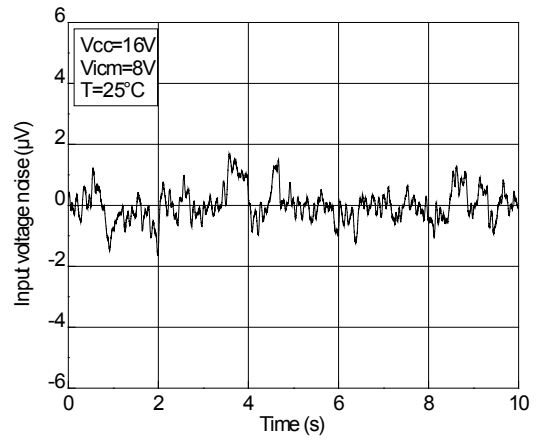

Figure 25. 0.1 to 10 Hz noise



## 5 Application information

### 5.1 Operating voltages

The LMC6482 device can operate from 2.7 to 16 V. The parameters are fully specified for 4 V, 10 V, and 16 V power supplies. However, the parameters are very stable in the full  $V_{CC}$  range. Additionally, the main specifications are guaranteed in extended temperature ranges from -40 to 125 °C.

### 5.2 Input pin voltage ranges

The LMC6482 device have internal ESD diode protection on the inputs. These diodes are connected between the input and each supply rail to protect the input MOSFETs from electrical discharge.

If the input pin voltage exceeds the power supply by 0.5 V, the ESD diodes become conductive and excessive current can flow through them. Without limitation this over current can damage the device.

In this case, it is important to limit the current to 10 mA, by adding resistance on the input pin, as described in figure below.

Figure 26. Input current limitation

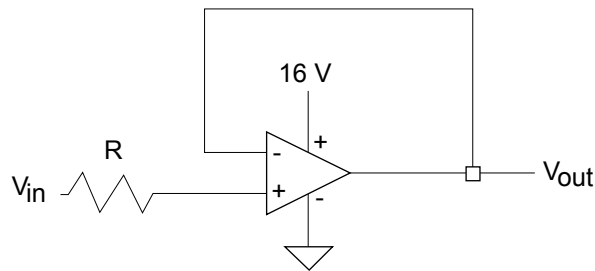

### 5.3 Rail-to-rail input

The LMC6482 device have a rail-to-rail input, and the input common mode range is extended from  $(V_{CC-}) - 0.1$  V to  $(V_{CC+}) + 0.1$  V.

### 5.4 Rail-to-rail output

The operational amplifier output levels can go close to the rails: to a maximum of 40 mV above and below the rail when connected to a 10 k $\Omega$  resistive load to  $V_{CC}/2$ .

### 5.5 Input offset voltage drift over temperature

The maximum input voltage drift variation over temperature is defined as the offset variation related to the offset value measured at 25 °C. The operational amplifier is one of the main circuits of the signal conditioning chain, and the amplifier input offset is a major contributor to the chain accuracy. The signal chain accuracy at 25 °C can be compensated during production at application level. The maximum input voltage drift over temperature enables the system designer to anticipate the effect of temperature variations.

The maximum input voltage drift over temperature is computed using Equation 1.

$$\frac{\Delta V_{io}}{\Delta T} = \max \left| \frac{V_{io}(T) - V_{io}(25^{\circ}\text{C})}{T - 25^{\circ}\text{C}} \right| \quad (1)$$

where  $T = -40$  °C and 125 °C.

The LMC6482 datasheet maximum values are guaranteed by measurements on a representative sample size ensuring a  $C_{pk}$  (process capability index) greater than 1.3.

## 5.6 Long term input offset voltage drift

To evaluate product reliability, two types of stress acceleration are used:

Voltage acceleration, by changing the applied voltage

Temperature acceleration, by changing the die temperature (below the maximum junction temperature allowed by the technology) with the ambient temperature.

The voltage acceleration has been defined based on JEDEC results, and is defined using Equation 2

$$A_{FV} = e^{\beta \cdot V_S - V_U} \quad (2)$$

where:

$A_{FV}$  is the voltage acceleration factor

$\beta$  is the voltage acceleration constant in  $1/V$ , constant technology parameter ( $\beta = 1$ )

$V_S$  is the stress voltage used for the accelerated test

$V_U$  is the voltage used for the application

The temperature acceleration is driven by the Arrhenius model, and is defined in Equation 3

$$A_{FT} = e^{\frac{E_a}{k} \cdot \left( \frac{1}{T_U} - \frac{1}{T_S} \right)} \quad (3)$$

Where:

$A_{FT}$  is the temperature acceleration factor

$E_a$  is the activation energy of the technology based on the failure rate  $k$  is the Boltzmann constant ( $8.6173 \times 10^{-5}$  eV.K<sup>-1</sup>)

$T_U$  is the temperature of the die when  $V_U$  is used (K)

$T_S$  is the temperature of the die under temperature stress (K)

The final acceleration factor,  $A_F$ , is the multiplication of the voltage acceleration factor and the temperature acceleration factor (Equation 4)

$$A_F = A_{FT} \times A_{FV} \quad (4)$$

$A_F$  is calculated using the temperature and voltage defined in the mission profile of the product. The  $A_F$  value can then be used in to calculate the number of months of use equivalent to 1000 hours of reliable stress duration.

$$Months = A_F \times 1000 \text{ h} \times 12 \text{ months} / 24 \text{ h} \times 365.25 \text{ days} \quad (5)$$

To evaluate the op amp reliability, a follower stress condition is used where  $V_{CC}$  is defined as a function of the maximum operating voltage and the absolute maximum rating (as recommended by JEDEC rules).

The  $V_{io}$  drift (in  $\mu V$ ) of the product after 1000 h of stress is tracked with parameters at different measurement conditions (see equation 6)

$$V_{CC} = \max V_{PP} \text{ with } V_{icm} = V_{CC}/2 \quad (6)$$

The long term drift parameter ( $\Delta V_{io}$ ), estimating the reliability performance of the product, is obtained using the ratio of the  $V_{io}$  (input offset voltage value) drift over the square root of the calculated number of months (Equation 7)

$$\Delta V_{io} = \frac{V_{io} \text{ drift}}{\sqrt{months}} \quad (7)$$

Where  $V_{io}$  drift is the measured drift value in the specified test conditions after 1000 h stress duration.

### 5.7 High values of input differential voltage

In a closed loop configuration, which represents the typical use of an op amp, the input differential voltage is low (close to  $V_{IO}$ ). However, some specific conditions can lead to higher input differential values, such as:

- operation in an output saturation state
- operation at speeds higher than the device bandwidth, with output voltage dynamics limited by slew rate.
- use of the amplifier in a comparator configuration, hence in open loop

Use of the LMC6482 in comparator configuration, especially combined with high temperature and long duration can create a permanent drift of  $V_{IO}$ .

### 5.8 Capacitive load

Driving large capacitive loads can cause stability problems. Increasing the load capacitance produces gain peaking in the frequency response, with overshoot and ringing in the step response. It is usually considered that with a gain peaking higher than 2.3 dB an op amp might become unstable.

Generally, the unity gain configuration is the worst case for stability and the ability to drive large capacitive loads. Figure below "Stability criteria with a serial resistor at different supply voltage" shows the serial resistor that must be added to the output, to make a system stable. The [Figure 28. Test configuration for Riso](#) shows the test configuration using an isolation resistor, Riso.

**Figure 27. Stability criteria with a serial resistor at different supply voltage**

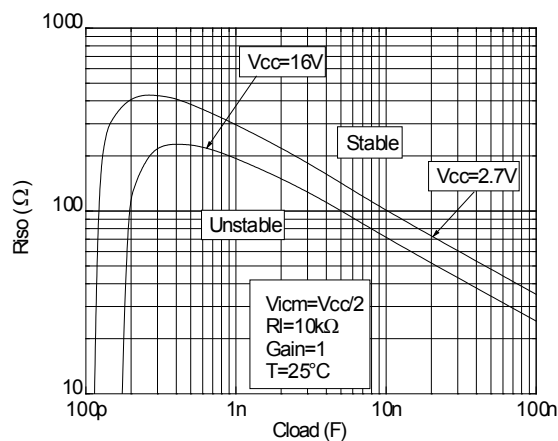

**Figure 28. Test configuration for Riso**

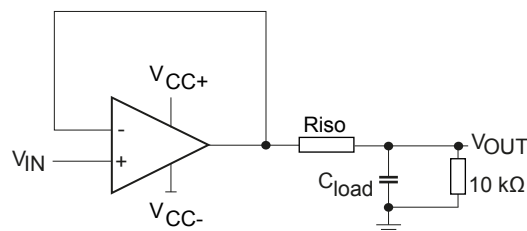

### 5.9 PCB layout recommendations

Particular attention must be paid to the layout of the PCB, tracks connected to the amplifier, load, and power supply. The power and ground traces are critical as they must provide adequate energy and grounding for all circuits. The best practice is to use short and wide PCB traces to minimize voltage drops and parasitic inductance.



In addition, to minimize parasitic impedance over the entire surface, a multi-via technique that connects the bottom and top layer ground planes together in many locations is often used.

The copper traces that connect the output pins to the load and supply pins should be as wide as possible to minimize trace resistance.

## 5.10 Optimized application recommendation

It is recommended to place a 22 nF capacitor as close as possible to the supply pin. A good decoupling will help to reduce electromagnetic interference impact.

## 6 Package information

In order to meet environmental requirements, ST offers these devices in different grades of ECOPACK® packages, depending on their level of environmental compliance. ECOPACK® specifications, grade definitions and product status are available at: [www.st.com](http://www.st.com). ECOPACK® is an ST trademark.

### 6.1 MiniSO8 package information

Figure 29. MiniSO8 package outline

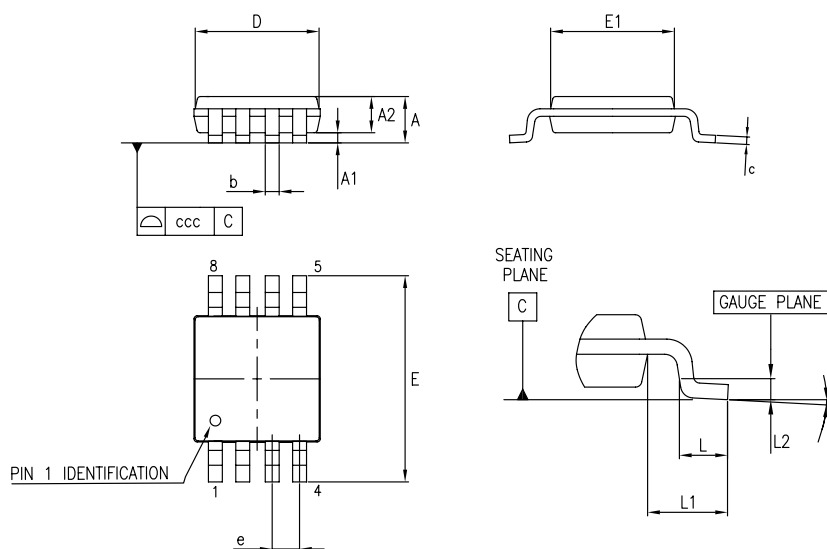

Table 6. MiniSO8 mechanical data

| Dim. | Millimeters |      |      | Inches |       |       |
|------|-------------|------|------|--------|-------|-------|
|      | Min.        | Typ. | Max. | Min.   | Typ.  | Max.  |
| A    |             |      | 1.1  |        |       | 0.043 |
| A1   | 0           |      | 0.15 | 0      |       | 0.006 |
| A2   | 0.75        | 0.85 | 0.95 | 0.03   | 0.033 | 0.037 |
| b    | 0.22        |      | 0.4  | 0.009  |       | 0.016 |
| c    | 0.08        |      | 0.23 | 0.003  |       | 0.009 |
| D    | 2.8         | 3    | 3.2  | 0.11   | 0.118 | 0.126 |
| E    | 4.65        | 4.9  | 5.15 | 0.183  | 0.193 | 0.203 |
| E1   | 2.8         | 3    | 3.1  | 0.11   | 0.118 | 0.122 |
| e    |             | 0.65 |      |        | 0.026 |       |
| L    | 0.4         | 0.6  | 0.8  | 0.016  | 0.024 | 0.031 |
| L1   |             | 0.95 |      |        | 0.037 |       |
| L2   |             | 0.25 |      |        | 0.01  |       |
| k    | 0°          |      | 8°   | 0°     |       | 8°    |
| ccc  |             |      | 0.1  |        |       | 0.004 |

## 6.2 SO8 package information

Figure 30. SO8 package outline

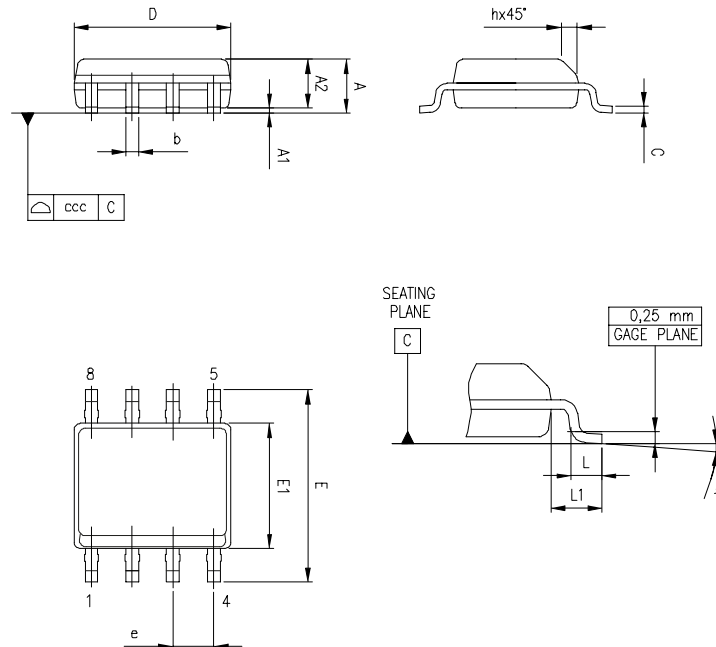

Table 7. SO-8 mechanical data

| Dim. | Millimeters |      |      | Inches |       |       |
|------|-------------|------|------|--------|-------|-------|
|      | Min.        | Typ. | Max. | Min.   | Typ.  | Max.  |
| A    |             |      | 1.75 |        |       | 0.069 |
| A1   | 0.1         |      | 0.25 | 0.004  |       | 0.01  |
| A2   | 1.25        |      |      | 0.049  |       |       |
| b    | 0.28        |      | 0.48 | 0.011  |       | 0.019 |
| c    | 0.17        |      | 0.23 | 0.007  |       | 0.01  |
| D    | 4.8         | 4.9  | 5    | 0.189  | 0.193 | 0.197 |
| E    | 5.8         | 6    | 6.2  | 0.228  | 0.236 | 0.244 |
| E1   | 3.8         | 3.9  | 4    | 0.15   | 0.154 | 0.157 |
| e    |             | 1.27 |      |        | 0.05  |       |
| h    | 0.25        |      | 0.5  | 0.01   |       | 0.02  |
| L    | 0.4         |      | 1.27 | 0.016  |       | 0.05  |
| L1   |             | 1.04 |      |        | 0.04  |       |
| k    | 0           |      | 8 °  | 1 °    |       | 8 °   |
| ccc  |             |      | 0.1  |        |       | 0.004 |

## 7 Ordering information

**Table 8. Order code**

| Order code | Temperature range | Package | Packing       |
|------------|-------------------|---------|---------------|
| LMC6482IDT | -40° to +125 °C   | SO8     | Tape and reel |
| LMC6482IST |                   | MiniSO8 |               |

## Revision history

**Table 9. Document revision history**

| Date        | Revision | Changes   |
|-------------|----------|---|
| 24-Jul-2018 | 1        | Initial release.  |
| 12-Sep-2018 | 2        | Updated the temperature range value in <a href="#">Table 8</a> . <a href="#">Order code</a> . |

## Contents

|          |  |           |
|----------|--|-----------|
| <b>1</b> | <b>Pin configuration</b> .....                                 | <b>2</b>  |
| <b>2</b> | <b>Absolute maximum ratings and operating conditions</b> ..... | <b>3</b>  |
| <b>3</b> | <b>Electrical characteristics</b> .....                        | <b>4</b>  |
| <b>4</b> | <b>Electrical characteristic curves</b> .....                  | <b>9</b>  |
| <b>5</b> | <b>Application information</b> .....                           | <b>14</b> |
| 5.1      | Operating voltages .....                                       | 14        |
| 5.2      | Input pin voltage ranges .....                                 | 14        |
| 5.3      | Rail-to-rail input .....                                       | 14        |
| 5.4      | Rail-to-rail output .....                                      | 14        |
| 5.5      | Input offset voltage drift over temperature .....              | 14        |
| 5.6      | Long term input offset voltage drift .....                     | 15        |
| 5.7      | High values of input differential voltage .....                | 15        |
| 5.8      | Capacitive load .....  | 16        |
| 5.9      | PCB layout recommendations .....                               | 16        |
| 5.10     | Optimized application recommendation .....                     | 17        |
| <b>6</b> | <b>Package information</b> .....                               | <b>18</b> |
| 6.1      | MiniSO8 package information .....                              | 18        |
| 6.2      | SO8 package information .....                                  | 18        |
| <b>7</b> | <b>Ordering information</b> .....                              | <b>20</b> |
|          | <b>Revision history</b> .....                                  | <b>21</b> |

## List of tables

|                 |                                      |    |
|-----------------|--------------------------------------|----|
| <b>Table 1.</b> | Absolute maximum ratings . . . . .   | 3  |
| <b>Table 2.</b> | Operating conditions . . . . .       | 3  |
| <b>Table 3.</b> | Electrical characteristics . . . . . | 4  |
| <b>Table 4.</b> | Electrical characteristics . . . . . | 5  |
| <b>Table 5.</b> | Electrical characteristics . . . . . | 7  |
| <b>Table 6.</b> | MiniSO8 mechanical data . . . . .    | 18 |
| <b>Table 7.</b> | SO-8 mechanical data . . . . .       | 19 |
| <b>Table 8.</b> | Order code . . . . .                 | 20 |
| <b>Table 9.</b> | Document revision history . . . . .  | 21 |

## List of figures

|                   |  |    |
|-------------------|--|----|
| <b>Figure 1.</b>  | Pin connection (top view) . . . . .  | 2  |
| <b>Figure 2.</b>  | Supply current vs. supply voltage . . . . .  | 9  |
| <b>Figure 3.</b>  | Input offset voltage distribution at $V_{CC} = 16\text{ V}$ . . . . .                  | 9  |
| <b>Figure 4.</b>  | Input offset voltage distribution at $V_{CC} = 4\text{ V}$ . . . . .                   | 9  |
| <b>Figure 5.</b>  | Channel separation . . . . .   | 9  |
| <b>Figure 6.</b>  | Output current vs. output voltage at $V_{CC} = 2.7\text{ V}$ . . . . .                 | 10 |
| <b>Figure 7.</b>  | Output current vs. output voltage at $V_{CC} = 16\text{ V}$ . . . . .                  | 10 |
| <b>Figure 8.</b>  | Output low voltage vs. supply voltage . . . . .  | 10 |
| <b>Figure 9.</b>  | Output high voltage (drop from $V_{CC+}$ ) vs. supply voltage . . . . .                | 10 |
| <b>Figure 10.</b> | Output voltage vs. input voltage close to the rail at $V_{CC} = 16\text{ V}$ . . . . . | 10 |
| <b>Figure 11.</b> | Slew rate vs. supply voltage . . . . .   | 10 |
| <b>Figure 12.</b> | Negative slew rate at $V_{CC} = 16\text{ V}$ . . . . .                                 | 11 |
| <b>Figure 13.</b> | Positive slew rate at $V_{CC} = 16\text{ V}$ . . . . .                                 | 11 |
| <b>Figure 14.</b> | Response to a small input voltage step . . . . .                                       | 11 |
| <b>Figure 15.</b> | Recovery behavior after a negative step on the input . . . . .                         | 11 |
| <b>Figure 16.</b> | Recovery behavior after a positive step on the input . . . . .                         | 11 |
| <b>Figure 17.</b> | Bode diagram at $V_{CC} = 2.7\text{ V}$ . . . . .                                      | 11 |
| <b>Figure 18.</b> | Bode diagram at $V_{CC} = 16\text{ V}$ . . . . .                                       | 12 |
| <b>Figure 19.</b> | Power supply rejection ratio (PSRR) vs. frequency . . . . .                            | 12 |
| <b>Figure 20.</b> | Output overshoot vs. capacitive load . . . . .   | 12 |
| <b>Figure 21.</b> | Output impedance vs. frequency in closed loop configuration . . . . .                  | 12 |
| <b>Figure 22.</b> | THD + N vs. frequency . . . . .  | 12 |
| <b>Figure 23.</b> | THD + N vs. output voltage . . . . .   | 12 |
| <b>Figure 24.</b> | Noise vs. frequency. . . . .   | 13 |
| <b>Figure 25.</b> | 0.1 to 10 Hz noise. . . . .  | 13 |
| <b>Figure 26.</b> | Input current limitation . . . . .   | 14 |
| <b>Figure 27.</b> | Stability criteria with a serial resistor at different supply voltage . . . . .        | 16 |
| <b>Figure 28.</b> | Test configuration for Riso . . . . .  | 16 |
| <b>Figure 29.</b> | MiniSO8 package outline . . . . .  | 18 |
| <b>Figure 30.</b> | SO8 package outline . . . . .  | 19 |