

Low cost, low power, input/output rail-to-rail operational amplifiers

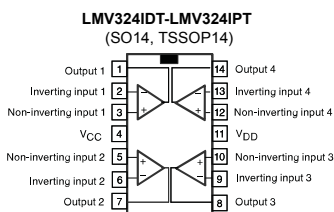
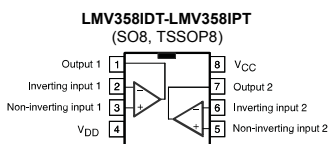
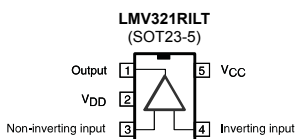
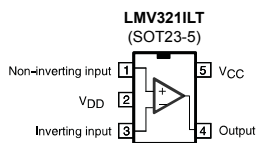

Features

- Operating range from $V_{CC} = 2.7$ to 6 V
- Rail-to-rail input and output
- Extended V_{icm} ($V_{DD} - 0.2$ V to $V_{CC} + 0.2$ V)
- Low supply current (145 μ A)
- Gain bandwidth product (1 MHz)
- ESD tolerance (2 kV)

Related products

- See [LMV321L](#), [LMV324L](#), [LMV358L](#) for newer technological version
- See [TSV851](#), [TSV852](#), [TSV854](#) for enhanced performances

Applications

- Battery powered electronic equipment
- Personal medical care (glucose meters)
- Laptops

Maturity status link

[LMV321](#)
[LMV324](#)
[LMV358](#)

Description

The [LMV321/LMV324/LMV358](#) family (single, dual, and quad) answers the need for low cost, general-purpose operational amplifiers. They operate with voltages as low as 2.7 V and feature both input and output rail-to-rail, 145 μ A consumption current, and 1 MHz gain bandwidth product (GBP).

With such a low consumption and a sufficient GBP for many applications, these op amps are well suited for any kind of battery supplied and portable equipment application.

The [LMV321](#) device is housed in the space-saving 5-pin SOT23-5 package, which simplifies board design. The SOT23-5 has two pinning configurations to answer all application requirements.

1 Absolute maximum ratings and operating conditions

Table 1. Absolute maximum ratings

Symbol	Parameter	Value	Unit	
V_{CC}	Supply voltage ⁽¹⁾	7	V	
V_{id}	Differential input voltage ⁽²⁾	±1		
V_{in}	Input voltage	$V_{DD} - 0.3$ to $V_{CC} + 0.3$		
T_{oper}	Operating free air temperature range	-40 to 125	°C	
T_{stg}	Storage temperature	-65 to 150		
T_j	Maximum junction temperature	150		
R_{thja}	Thermal resistance junction-to-ambient ⁽³⁾	SOT23-5	250	°C/W
		SO8	125	
		TSSOP8	120	
		SO14	103	
		TSSOP14	100	
R_{thjc}	Thermal resistance junction-to-case ⁽³⁾	SOT23-5	81	
		SO8	40	
		TSSOP8	37	
		SO14	31	
		TSSOP14	32	
ESD	HBM: human body model ⁽⁴⁾	2	kV	
	MM: machine model ⁽⁵⁾	200	V	
	CDM: charged device model ⁽⁶⁾	1.5	kV	
	Lead temperature (soldering, 10 s)	250	°C	
	Output short-circuit duration	See ⁽⁷⁾		

1. All voltage values, except differential voltage are with respect to network terminal.
2. The differential voltage is the non-inverting input terminal with respect to the inverting input terminal. If $V_{id} > \pm 1$ V, the maximum input current must not exceed ± 1 mA. In this case ($V_{id} > \pm 1$ V), an input series resistor must be added to limit input current.
3. Short-circuits can cause excessive heating. Destructive dissipation can result from simultaneous short-circuits on all amplifiers. All values are typical.
4. Human body model: a 100 pF capacitor is charged to the specified voltage, then discharged through a 1.5 kΩ resistor between two pins of the device. This is done for all couples of connected pin combinations while the other pins are floating.
5. Machine model: a 200 pF capacitor is charged to the specified voltage, then discharged directly between two pins of the device with no external series resistor (internal resistor < 5 Ω). This is done for all couples of connected pin combinations while the other pins are floating.
6. Charged device model: all pins and the package are charged together to the specified voltage and then discharged directly to the ground through only one pin. This is done for all pins. No value specified for CDM on SOT23-5 package. The value is given for SO8 and TSSOP packages.
7. Short-circuits from the output to V_{CC} can cause excessive heating. The maximum output current is approximately 48 mA, independent of the magnitude of V_{CC} . Destructive dissipation can result from simultaneous short-circuits on all amplifiers.

Table 2. Operating conditions

Symbol	Parameter	Value	Unit
V_{CC}	Supply voltage	2.7 to 6	V
V_{icm}	Common mode input voltage range ⁽¹⁾	$V_{DD} - 0.2$ to $V_{CC} + 0.2$	
V_{icm}	Common mode input voltage range ⁽²⁾	V_{DD} to V_{CC}	
T_{oper}	Operating free air temperature range	-40 to 125	°C

1. At 25 °C, for $2.7 \leq V_{CC} \leq 6$ V, V_{icm} is extended to $V_{DD} - 0.2$ V, $V_{CC} + 0.2$ V.

2. In full temperature range, both rails can be reached when V_{CC} does not exceed 5.5 V.

2 Electrical characteristics

Table 3. Electrical characteristics at $V_{CC} = 2.7\text{ V}$, $V_{DD} = 0\text{ V}$, C_L and R_L connected to $V_{CC}/2$, $T_{amb} = 25\text{ °C}$ (unless otherwise specified)

Symbol	Parameter	Conditions	Min.	Typ.	Max.	Unit
V_{io}	Input offset voltage	$V_{icm} = V_{out} = V_{CC}/2$		0.1	3	mV
		$T_{min} \leq T_{amb} \leq T_{max}$			6	
$\Delta V_{io}/\Delta T$	Input offset voltage drift			2		$\mu\text{V}/\text{°C}$
I_{io}	Input offset current	$V_{icm} = V_{out} = V_{CC}/2$ ⁽¹⁾		1	9	nA
		$T_{min} \leq T_{amb} \leq T_{max}$			25	
I_{ib}	Input bias current	$V_{icm} = V_{out} = V_{CC}/2$ ⁽¹⁾		10	50	
		$T_{min} \leq T_{amb} \leq T_{max}$			85	
CMR	Common mode rejection ratio	$0 \leq V_{icm} \leq V_{CC}$	55	85		dB
SVR	Supply voltage rejection ratio	$V_{icm} = V_{CC}/2$	70	80		
A_{vd}	Large signal voltage gain	$V_{out} = 0.5\text{ V to } 2.2\text{ V}$, $R_L = 10\text{ k}\Omega$	80	100		
		$V_{out} = 0.5\text{ V to } 2.2\text{ V}$, $R_L = 2\text{ k}\Omega$	70	88		
V_{OH}	High level output voltage	$V_{id} = 100\text{ mV}$, $T_{min} \leq T_{amb} \leq T_{max}$, $R_L = 10\text{ k}\Omega$	2.6	2.65		V
		$V_{id} = 100\text{ mV}$, $T_{min} \leq T_{amb} \leq T_{max}$, $R_L = 2\text{ k}\Omega$	2.55	2.6		
V_{OL}	Low level output voltage	$V_{id} = -100\text{ mV}$, $T_{min} \leq T_{amb} \leq T_{max}$, $R_L = 10\text{ k}\Omega$		15	90	mV
		$V_{id} = -100\text{ mV}$, $T_{min} \leq T_{amb} \leq T_{max}$, $R_L = 2\text{ k}\Omega$		50	100	
I_o	Output current	Output source current, $V_{id} = 100\text{ mV}$, $V_O = V_{DD}$	5	46		mA
		Output sink current, $V_{id} = -100\text{ mV}$, $V_O = V_{CC}$	5	46		
I_{CC}	Supply current (per amplifier)	$V_{out} = V_{CC}/2$, $A_{VCL} = 1$, no load		145	200	μA
		$T_{min} \leq T_{amb} \leq T_{max}$			230	
GBP	Gain bandwidth product	$R_L = 10\text{ k}\Omega$, $C_L = 100\text{ pF}$, $f = 100\text{ kHz}$		1		MHz
SR	Slew rate	$R_L = 600\ \Omega$, $C_L = 100\text{ pF}$, $A_V = 1$		0.35		$\text{V}/\mu\text{s}$
ϕ_m	Phase margin	$R_L = 600\ \Omega$, $C_L = 100\text{ pF}$		44		Degrees
en	Input voltage noise			40		$\text{nV}/\sqrt{\text{Hz}}$
THD	Total harmonic distortion			0.01		%

1. Maximum values include unavoidable inaccuracies of the industrial tests.

Table 4. Electrical characteristics at $V_{CC} = 5\text{ V}$, $V_{DD} = 0\text{ V}$, C_L and R_L connected to $V_{CC}/2$, $T_{amb} = 25\text{ °C}$ (unless otherwise specified)

Symbol	Parameter	Conditions	Min.	Typ.	Max.	Unit
V_{io}	Input offset voltage	$V_{icm} = V_{out} = V_{CC}/2$		0.1	3	mV
		$T_{min} \leq T_{amb} \leq T_{max}$			6	
$\Delta V_{io}/\Delta T$	Input offset voltage drift			2		$\mu\text{V}/\text{°C}$
I_{io}	Input offset current	$V_{icm} = V_{out} = V_{CC}/2$ ⁽¹⁾		1	9	nA
		$T_{min} \leq T_{amb} \leq T_{max}$			25	
I_{ib}	Input bias current	$V_{icm} = V_{out} = V_{CC}/2$ ⁽¹⁾		16	63	nA
		$T_{min} \leq T_{amb} \leq T_{max}$			95	
CMR	Common mode rejection ratio	$0 \leq V_{icm} \leq V_{CC}$	65	95		dB
SVR	Supply voltage rejection ratio	$V_{icm} = V_{CC}/2$	70	90		
A_{vd}	Large signal voltage gain	$V_{out} = 0.5\text{ V to }4.5\text{ V}$, $R_L = 10\text{ k}\Omega$	85	97		
		$V_{out} = 0.5\text{ V to }4.5\text{ V}$, $R_L = 2\text{ k}\Omega$	77	93		
V_{OH}	High level output voltage	$V_{id} = 100\text{ mV}$, $T_{min} \leq T_{amb} \leq T_{max}$, $R_L = 10\text{ k}\Omega$	4.85	4.95		V
		$V_{id} = 100\text{ mV}$, $T_{min} \leq T_{amb} \leq T_{max}$, $R_L = 2\text{ k}\Omega$	4.8	4.91		
V_{OL}	Low level output voltage	$V_{id} = -100\text{ mV}$, $T_{min} \leq T_{amb} \leq T_{max}$, $R_L = 10\text{ k}\Omega$		40	180	mV
		$V_{id} = -100\text{ mV}$, $T_{min} \leq T_{amb} \leq T_{max}$, $R_L = 2\text{ k}\Omega$		80	200	
I_o	Output current	Output source current, $V_{id} = 100\text{ mV}$, $V_O = V_{DD}$	7	48		mA
		Output sink current, $V_{id} = -100\text{ mV}$, $V_O = V_{CC}$	7	48		
I_{CC}	Supply current (per amplifier)	$V_{out} = V_{CC}/2$, $A_{VCL} = 1$, no load		162	220	μA
		$T_{min} \leq T_{amb} \leq T_{max}$			250	
GBP	Gain bandwidth product	$R_L = 10\text{ k}\Omega$, $C_L = 100\text{ pF}$, $f = 100\text{ kHz}$		1.3		MHz
SR	Slew rate	$R_L = 600\ \Omega$, $C_L = 100\text{ pF}$, $A_V = 1$		0.45		V/ μs
ϕ_m	Phase margin	$R_L = 600\ \Omega$, $C_L = 100\text{ pF}$		48		Degrees
e_n	Input voltage noise			40		nV/ $\sqrt{\text{Hz}}$
THD	Total harmonic distortion			0.01		%

1. Maximum values include unavoidable inaccuracies of the industrial tests.

Figure 1. Supply current/amplifier vs. supply voltage

Figure 2. Input bias current vs. temperature ($V_{CC} = 3\text{ V}$, $V_{icm} = 1.5\text{ V}$)

Figure 3. Input bias current vs. temperature ($V_{CC} = 5\text{ V}$, $V_{icm} = 2.5\text{ V}$)

Figure 4. Common mode rejection vs. temperature ($V_{CC} = 3\text{ V}$)

Figure 5. Common mode rejection vs. temperature ($V_{CC} = 5\text{ V}$)

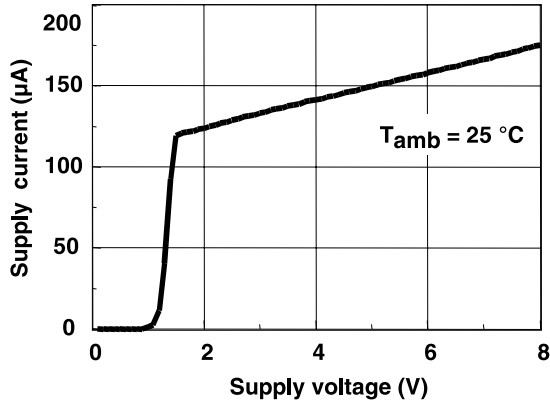
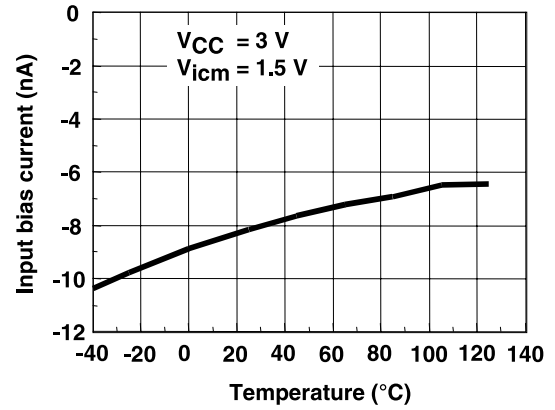
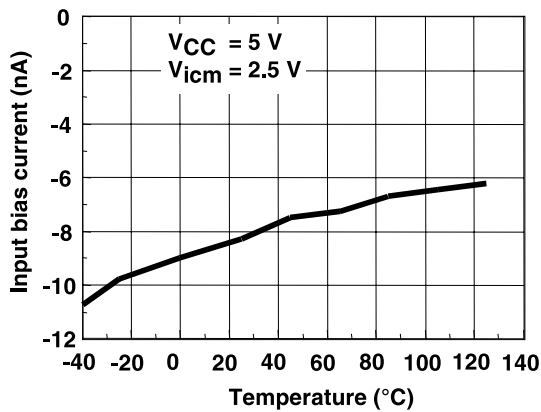
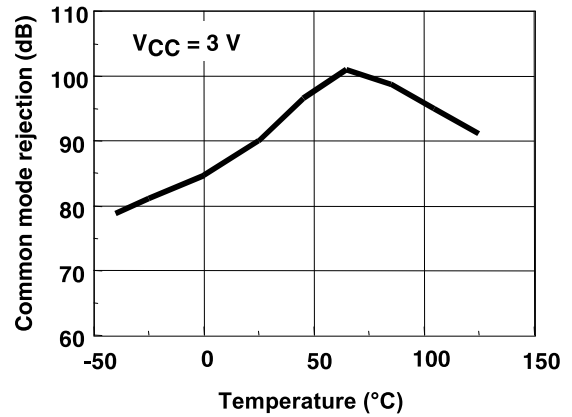
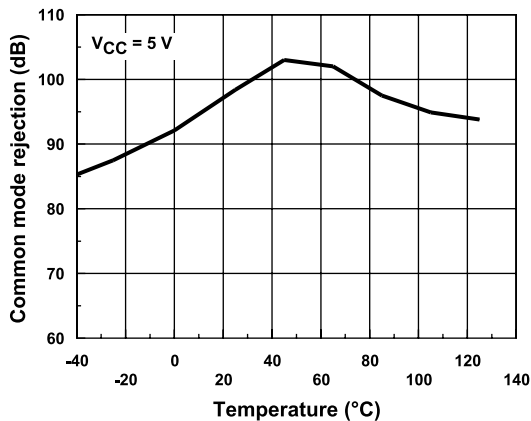
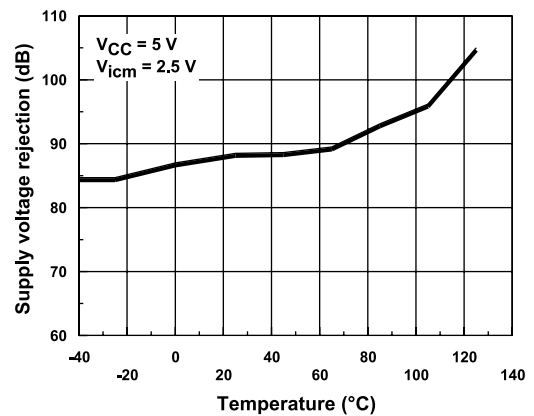
Figure 6. Supply voltage rejection vs. temperature ($V_{CC} = 5\text{ V}$, $V_{icm} = 2.5\text{ V}$)

Figure 7. Open loop gain vs. temperature ($V_{CC} = 3\text{ V}$, $R_L = 10/2\text{ kW}$)

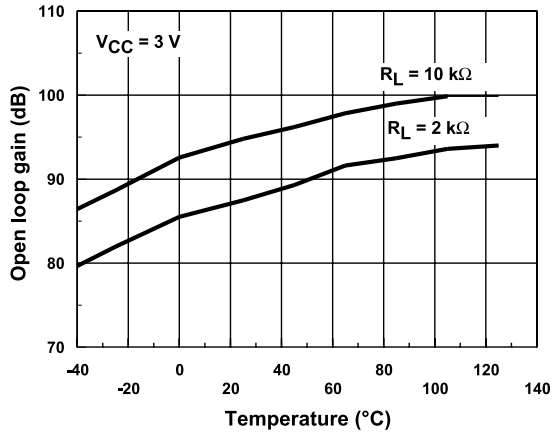

Figure 8. Open loop gain vs. temperature ($V_{CC} = 5\text{ V}$, $R_L = 10/2\text{ kW}$)

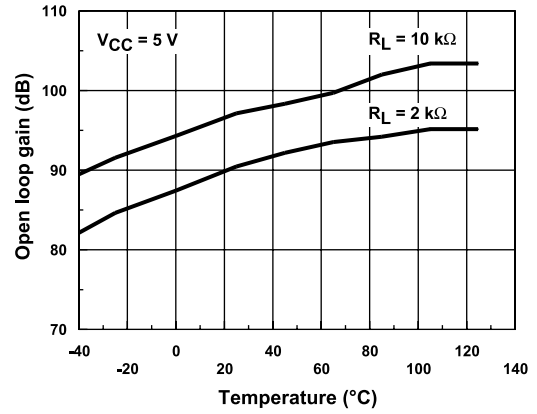

Figure 9. Supply voltage rejection vs. temperature ($V_{CC} = 3\text{ V}$, $V_{icm} = 1.5\text{ V}$)

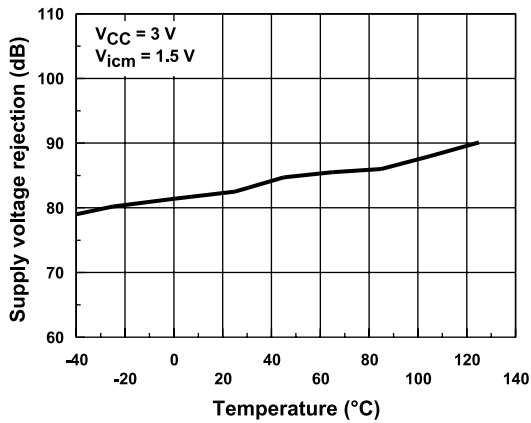

Figure 10. Output current vs. output voltage ($V_{CC} = 3\text{ V}$, $V_{id} = 0.1\text{ V}$, $V_{icm} = 1.5\text{ V}$)

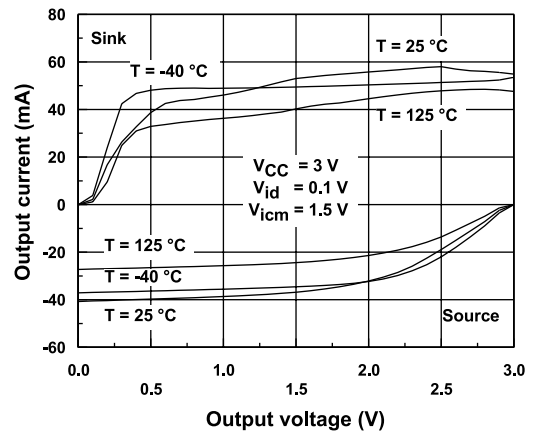

Figure 11. Output current vs. output voltage ($V_{CC} = 5\text{ V}$, $V_{id} = 0.1\text{ V}$, $V_{icm} = 2.5\text{ V}$)

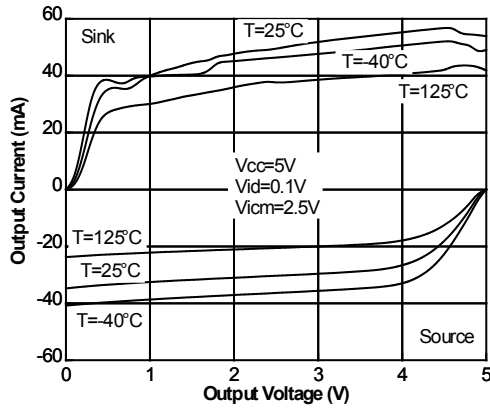

Figure 12. Noise versus frequency

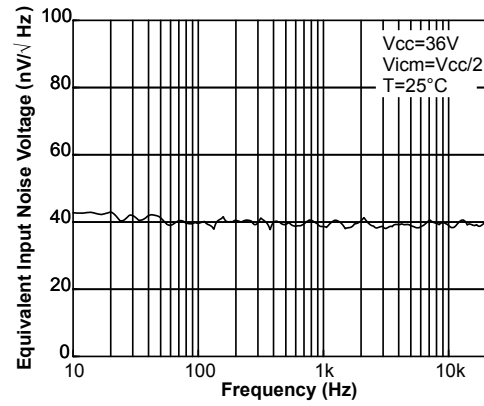
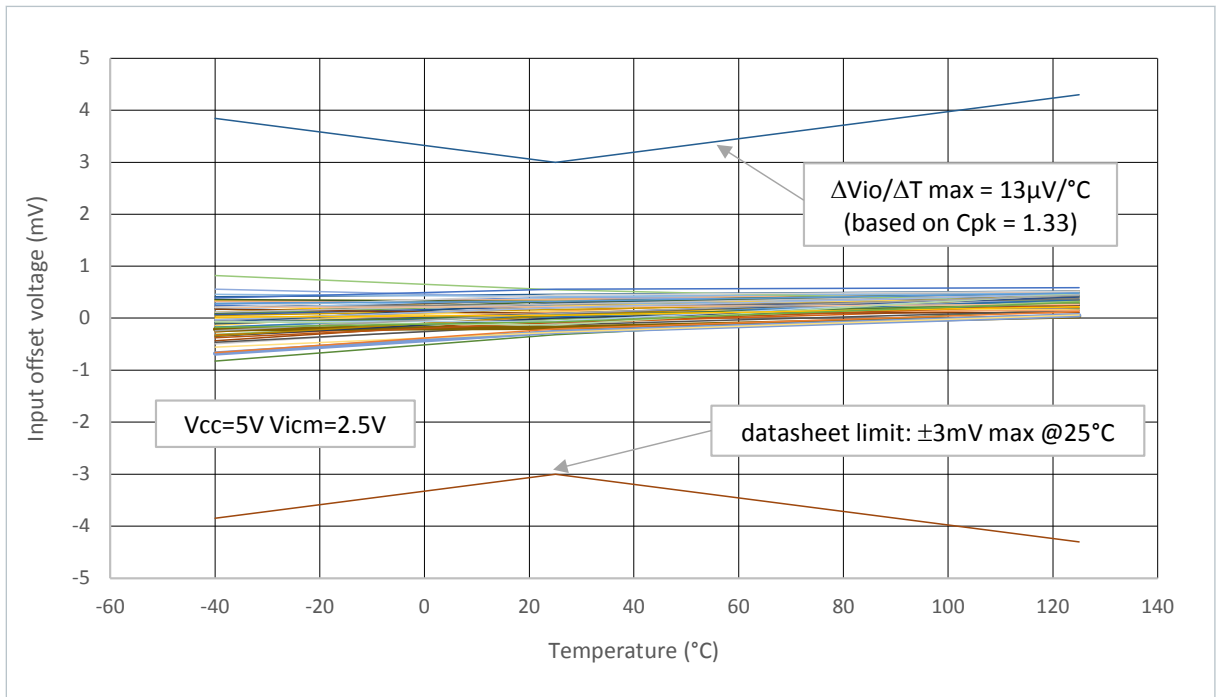

Figure 13. LMV358YPT Input offset voltage vs. temperature at 5 V supply voltage



3 Package information

In order to meet environmental requirements, ST offers these devices in different grades of **ECOPACK** packages, depending on their level of environmental compliance. ECOPACK specifications, grade definitions and product status are available at: www.st.com. ECOPACK is an ST trademark.

3.1 SOT23-5 package information

Figure 14. SOT23-5 package outline

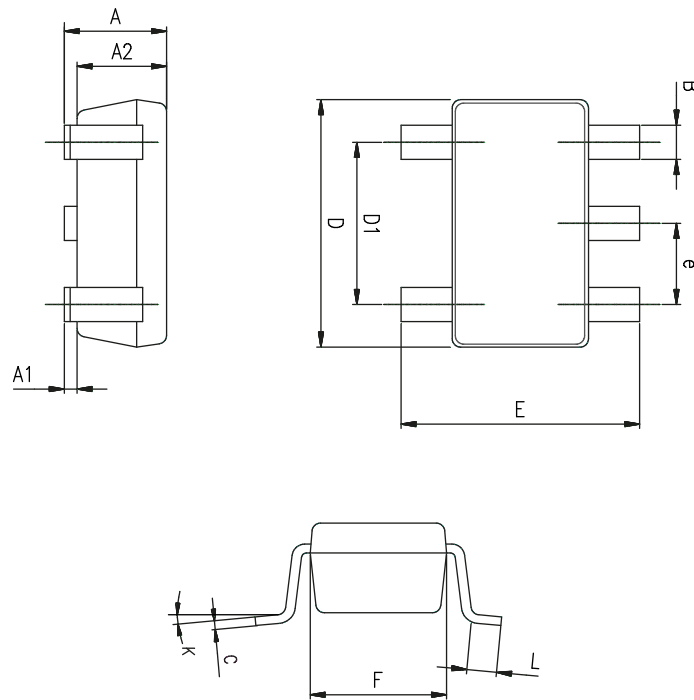

Table 5. SOT23-5 mechanical data

Ref.	Dimensions					
	Millimeters			Inches		
	Min.	Typ.	Max.	Min.	Typ.	Max.
A	0.90	1.20	1.45	0.035	0.047	0.057
A1			0.15			0.006
A2	0.90	1.05	1.30	0.035	0.041	0.051
B	0.35	0.40	0.50	0.014	0.016	0.020
C	0.09	0.15	0.20	0.004	0.006	0.008
D	2.80	2.90	3.00	0.110	0.114	0.118
D1		1.90			0.075	
e		0.95			0.037	
E	2.60	2.80	3.00	0.102	0.110	0.118
F	1.50	1.60	1.75	0.059	0.063	0.069
L	0.10	0.35	0.60	0.004	0.014	0.024
K	0 degrees		10 degrees	0 degrees		10 degrees

3.2 SO8 package information

Figure 15. SO8 package outline

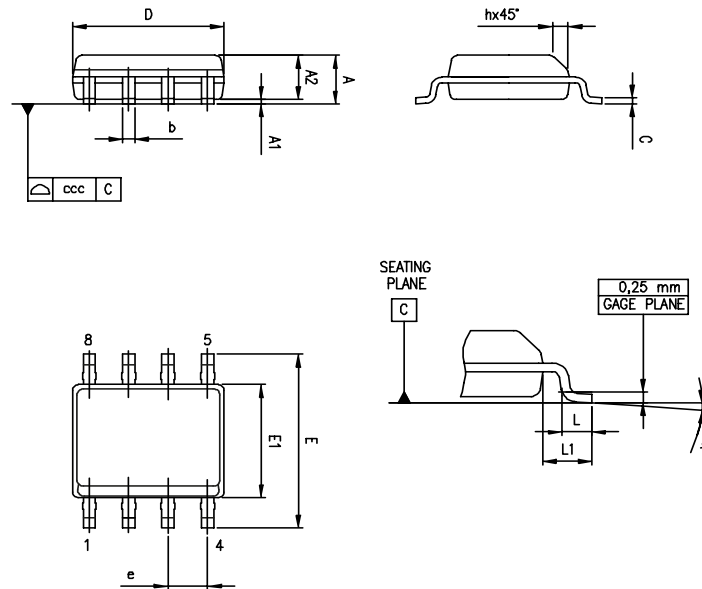

Table 6. SO8 package mechanical data

Ref.	Dimensions					
	Millimeters			Inches		
	Min.	Typ.	Max.	Min.	Typ.	Max.
A			1.75			0.069
A1	0.10		0.25	0.004		0.010
A2	1.25			0.049		
b	0.28		0.48	0.011		0.019
c	0.17		0.23	0.007		0.010
D	4.80	4.90	5.00	0.189	0.193	0.197
E	5.80	6.00	6.20	0.228	0.236	0.244
E1	3.80	3.90	4.00	0.150	0.154	0.157
e		1.27			0.050	
h	0.25		0.50	0.010		0.020
L	0.40		1.27	0.016		0.050
L1		1.04			0.040	
k	0°		8°	0°		8°
ccc			0.10			0.004

3.3 TSSOP8 package information

Figure 16. TSSOP8 package outline

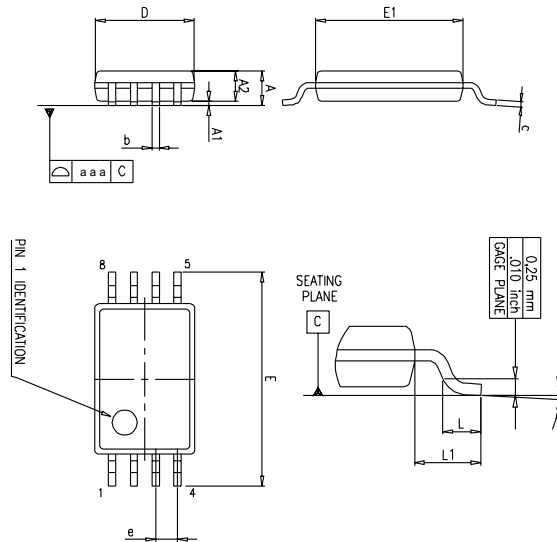
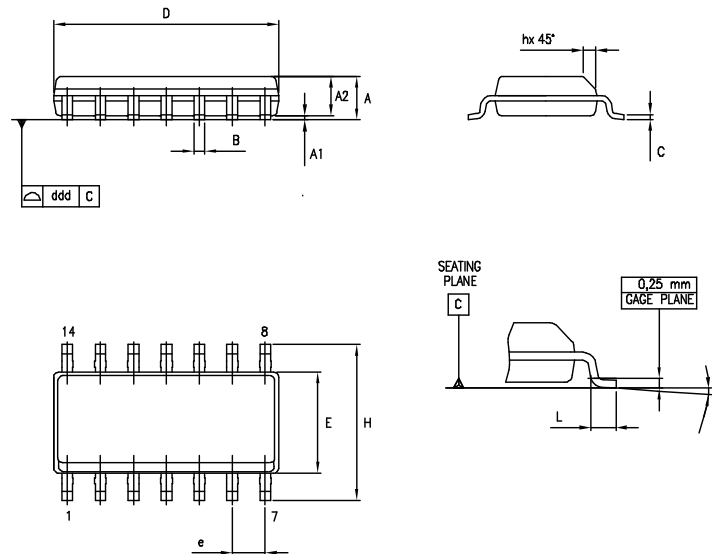

Table 7. TSSOP8 package mechanical data

Ref.	Dimensions					
	Millimeters			Inches		
	Min.	Typ.	Max.	Min.	Typ.	Max.
A			1.20			0.047
A1	0.05		0.15	0.002		0.006
A2	0.80	1.00	1.05	0.031	0.039	0.041
b	0.19		0.30	0.007		0.012
c	0.09		0.20	0.004		0.008
D	2.90	3.00	3.10	0.114	0.118	0.122
E	6.20	6.40	6.60	0.244	0.252	0.260
E1	4.30	4.40	4.50	0.169	0.173	0.177
e		0.65			0.0256	
k	0°		8°	0°		8°
L	0.45	0.60	0.75	0.018	0.024	0.030
L1		1			0.039	
aaa			0.10			0.004

3.4 SO14 package information

Figure 17. SO14 package outline

Table 8. SO14 package mechanical data

Ref.	Dimensions					
	Millimeters			Inches		
	Min.	Typ.	Max.	Min.	Typ.	Max.
			1.75			0.069
A	1.35		1.75	0.05		0.068
A1	0.10		0.25	0.004		0.009
A2	1.10		1.65	0.04		0.06
B	0.33		0.51	0.01		0.02
C	0.19		0.25	0.007		0.009
D	8.55		8.75	0.33		0.34
E	3.80		4.0	0.15		0.15
e		1.27			0.05	
H	5.80		6.20	0.22		0.24
h	0.25		0.50	0.009		0.02
L	0.40		1.27	0.015		0.05
k	8° (max.)					
ddd			0.10			0.004

3.5 TSSOP14 package information

Figure 18. TSSOP14 package outline

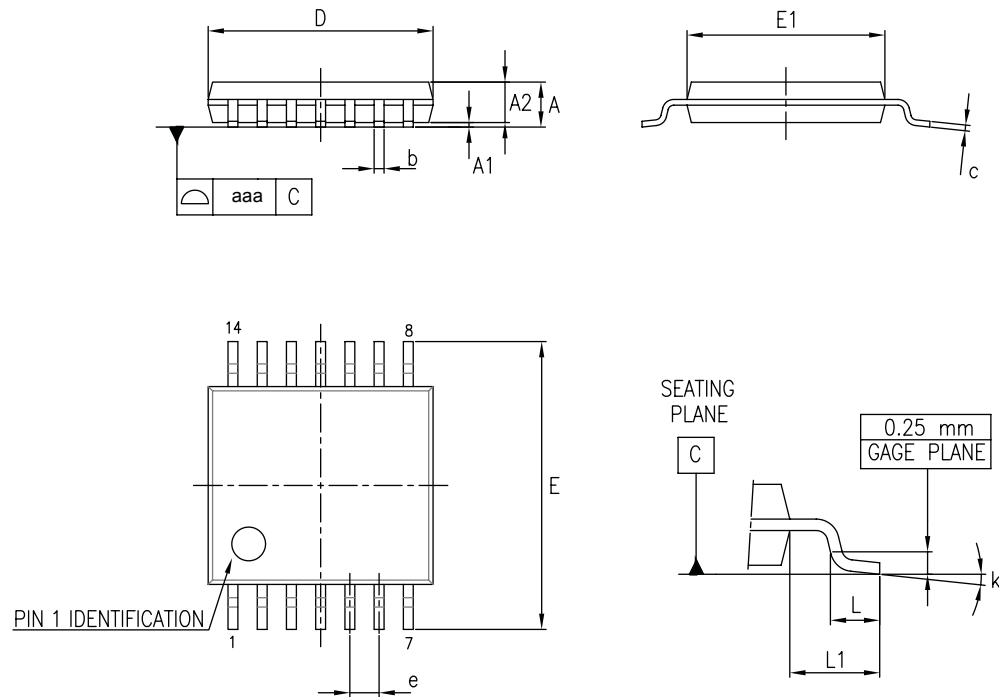

Table 9. TSSOP14 package mechanical data

Ref.	Dimensions					
	Millimeters			Inches		
	Min.	Typ.	Max.	Min.	Typ.	Max.
A			1.20			0.047
A1	0.05		0.15	0.002	0.004	0.006
A2	0.80	1.00	1.05	0.031	0.039	0.041
b	0.19		0.30	0.007		0.012
c	0.09		0.20	0.004		0.0089
D	4.90	5.00	5.10	0.193	0.197	0.201
E	6.20	6.40	6.60	0.244	0.252	0.260
E1	4.30	4.40	4.50	0.169	0.173	0.176
e		0.65			0.0256	
L	0.45	0.60	0.75	0.018	0.024	0.030
L1		1.00			0.039	
k	0°		8°	0°		8°
aaa			0.10			0.004

4 Ordering information

Table 10. Order codes

Order code	Temperature range	Package	Packaging	Marking
LMV321ILT	-40 °C to 125 °C	SOT23-5	Tape and reel	K177
LMV321RILT				K176
LMV321IYLT ⁽¹⁾		SOT23-5 (automotive grade)		K180
LMV321RIYLT ⁽¹⁾				K185
LMV358IDT		SO8		LMV358
LMV358IYDT ⁽¹⁾		SO8 (automotive grade)		LMV358IY
LMV358IPT		TSSOP8		MV358
LMV358IYPT ⁽¹⁾		TSSOP8 (automotive grade)		K181Y
LMV324IDT		SO14		LMV324
LMV324IYDT ⁽¹⁾		SO14 (automotive grade)		V324Y
LMV324IPT		TSSOP14		MV324
LMV324IYPT ⁽¹⁾		TSSOP14 (automotive grade)		V324IY

1. Qualified and characterized according to AEC Q100 and Q003 or equivalent, advanced screening according to AEC Q001 and Q 002 or equivalent.

Revision history

Table 11. Document revision history

Date	Revision	Changes
1-Dec-2005	1	First release - Products in full production.
25-May-2007	2	Added automotive grade part numbers to order codes table. Moved order codes table to Section 4: "Ordering information".
20-Feb-2008	3	Added Figure 12: "Noise versus frequency". Updated presentation of package information. Corrected footnote for automotive grade part numbers in order codes table.
18-Jan-2010	4	Updated document format. Updated packages in Section 3: "Package information". Modified Note 1 and added Note 2 under Table 10: "Order codes".
05-Nov-2012	5	Updated Features (added SO8, TSSOP8, SO14, and TSSOP14 package). Updated titles of Figure 2 to Figure 11 (added conditions). Updated LMV321RIYLT order code in Table 10: "Order codes" (status qualified), removed LMV358IYD and LMV324IYD order codes from Table 10: "Order codes". Minor corrections throughout document.
16-Aug-2013	6	Updated Features Added Related products Table 3 and Table 4: replaced ΔV_{io} with $\Delta V_{io}/\Delta T$ Table 6: updated minimum inches "k" value (0 instead of 1) Table 10: "Order codes": updated footnote associated with order code LMV358IYPT
05-Jun-2015	7	Updated Figure 11. TSSOP package information: updated "aaa" value Table 10: "Order codes": removed obsolete order codes LMV358ID and LMV324ID.
15-Oct-2015	8	Replaced Figure 12: "Noise versus frequency".
06-May-2019	9	Added Figure 13. LMV358IYPT Input offset voltage vs. temperature at 5 V supply voltage.